

PTAC/PTHP

PACKAGED TERMINAL AIR CONDITIONER

Service Manual

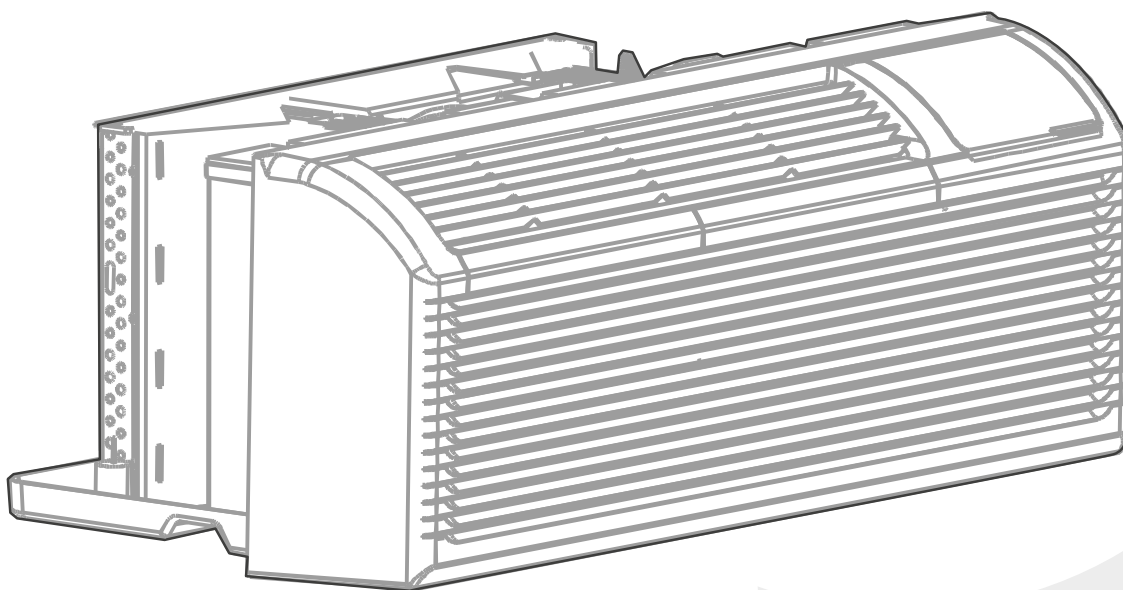

KLIMAIRE[®] ≈

Mark of Superior Quality

IMPORTANT NOTE:

Read this manual carefully before installing or operating your new air conditioning unit. Make sure to save this manual for future reference.

For more information please visit www.klimaire.com



IMIQ 24-07



A2L

Table of Contents

§. Safety Precautions

1. Precautions
2. Information servicing(For flammable materials)

§. Specifications

1. Model Reference
2. Nomenclature
3. Specifications
4. Unit Components
5. Dimension
6. Refrigerant Cycle Diagrams
7. Electrical Wiring Diagrams
8. PCB Printed Diagrams

§. Function and Control Panel

1. Control panel
2. Safety Features
3. Basic Features

§. Installation Details

1. Before you get start
2. Before the installation
3. Installation overview

§. Troubleshooting

1. General Troubleshooting
2. Engineering Mode
3. Troubleshooting by Error Code

§. Unit Disassembly

Appendix

- i) Temperature Sensor Resistance Value Table for T1,T2,T3 and T4 (°C – K)
- ii) Temperature Sensor Resistance Value Table for T5&T6(°C – K)
- iii) Pressure On Service Port

Safety Precautions

Contents

1.	Precautions.....	2
2.	Information servicing(For flammable materials).....	4

1. Safety Precautions

To prevent injury to the user or other people and property damage, the following instructions must be followed.

Incorrect operation due to ignoring of instructions may cause harm or damage. The seriousness is classified by the following indications.

Failure to adhere to all precautionary measures listed in this section may result in personal injury, damage to the unit or to property, or in extreme cases, death.

 **WARNING** indicates a potentially hazardous situation which if not avoided could result in serious personal injury, or death.

 **CAUTION** indicates a potentially hazardous situation which if not avoided could result in minor or moderate personal injury, or unit damage.

WARNING

- Plug in power plug properly. Otherwise, it may cause electric shock or fire due to excess heat generation. Do not operate or stop the unit by inserting or pulling out the power plug. It may cause electric shock or fire due to heat generation. Do not damage or use an unspecified power cord. It may cause electric shock or fire.
- The power cord plug should be inserted into a standard socket.
- Always install a circuit breaker and a dedicated power circuit. Incorrect installation may cause fire and electric shock. Do not operate with wet hands or in damp environment. It may cause electric shock. Do not direct airflow at room occupants only. This could damage your health.
- Always ensure effective grounding. Incorrect grounding may cause electric shock. Do not allow water to run into electric parts. It may cause failure of machine or electric shock.
- Do not modify power cord length or share the outlet with other appliances. It may cause electric shock or fire due to heat generation.
- Unplug the unit if strange sounds, smell, or smoke comes from it. It may cause fire and electric shock.
- Do not use the socket if it is loose or damaged. It may cause fire and electric shock. Do not open the unit during operation. It may cause electric shock.
- Keep firearms away. It may cause fire. Do not use the power cord close to heating appliances. It may cause fire and electric shock. Do not use the power cord near flammable gas or combustibles, such as gasoline, benzene, thinner, etc. It may cause an explosion or fire.

- Ventilate room before operating air conditioner if there is a gas leakage from another appliance. It may cause explosion, fire and, burns. Do not disassemble or modify unit. It may cause failure and electric shock.

CAUTION

- When the air filter is to be removed, do not touch the metal parts of the unit. It may cause an injury.
- Ventilate the room well when used together with a stove, etc. An oxygen shortage may occur.
- Do not use strong detergent such as wax or thinner but use a soft cloth.
- Appearance may be deteriorated due to change of product color or scratching of its surface. Do not clean the air conditioner with water.
- Water may enter the unit and degrade the insulation. It may cause an electric shock. Do not use for special purposes. Do not use this air conditioner to preserve precision devices, food, pets, plants, and art objects. It may cause deterioration of quality, etc.
- Stop operation and close the window in storm or hurricane. Operation with windows opened may cause wetting of indoor and soaking of household furniture.
- When the unit is to be cleaned, switch off, and turn off the circuit breaker.
- Do not clean unit when power is on as it may cause fire and electric shock, it may cause an injury.
- Always insert the filters securely. It can be caused failure if operated without filters. Please clean filter once every two weeks.
- Hold the plug by the head of the power plug when taking it out. It may cause electric shock and damage. Turn off the main power switch when not using the unit for a long time. It may cause failure of product or fire.
- Do not place obstacles around air-inlets or inside of air-outlet. It may cause failure of appliance or accident. Do not place heavy object on the power cord and ensure that the cord is not compressed. There is danger of fire or electric shock. Don't drink water drained from air conditioner. It contains contaminants and could make you sick.
- Use caution when unpacking and installing. Sharp edges could cause injury.
- If water enters the unit, turn the unit off at the power outlet and switch of the circuit breaker. Isolate supply by taking the power-plug out and contact a qualified service technician.
- This appliance is not intended for use by persons (including children) with reduced physical, sensory

or mental capabilities or lack of experience and knowledge, unless they have been given supervision or instruction concerning use of the appliance by a person responsible for their safety.

- Children should be supervised to ensure that they do not play with the appliance.
- If the supply cord is damaged, it must be replaced by the manufacturer, its service agent or similarly qualified persons in order to avoid a hazard.
- The appliance shall be installed in accordance with national wiring regulations.
- Installation must be performed in accordance with the requirement of NEC and CEC by authorized personnel only.
- Do not operate your air conditioner in a wet room such as a bathroom or laundry room.
- The appliance with electric heater shall have at least 1 meter space to the combustible materials.
- Contact the authorized service technician for repair or maintenance of this unit.
- Contact the authorized installer for installation of this unit.

WARNING

Electrical Information

The complete electrical rating of your new room air conditioner is stated on the serial plate. Refer to the rating when checking the electrical requirements.

- Be sure the air conditioner is properly grounded. To minimize shock and fire hazards, proper grounding is important. The power cord is equipped with a three-prong grounding plug for protection against shock hazards.
- Your air conditioner must be used in a properly grounded wall receptacle. If the wall receptacle you intend to use is not adequately grounded or protected by a time delay fuse or circuit breaker, have a qualified electrician install the proper receptacle. Ensure the receptacle is accessible after the unit installation.
- Do not run air conditioner without side protective cover in place. This could result in mechanical damage within the air conditioner.

Avoid fire hazard or electric shock. Do not use an extension cord or an adapter plug. Do not remove any prongs from the power cord.

For Your Safety

Do not store or use gasoline or other flammable vapors and liquids in the vicinity of this or any other appliance.

Prevent Accidents

To reduce the risk of fire, electrical shock, or injury to persons when using your air conditioner, follow basic precautions,

including the following:

- Be sure the electrical service is adequate for the model you have chosen. This information can be found on the serial plate, which is located on the side of the cabinet and behind the grille.
- Be sure the air conditioner has been securely and correctly installed according to the installation instructions in this manual. Save this manual for possible future use in removing or installing this unit. When handling the air conditioner, be careful to avoid cuts from sharp metal fins on front and rear coils.

Electrical Requirements

Electrical Shock and Personal Injury Hazard

Electrical ground is required on this appliance.

DO NOT ground to a gas line.

If cold water pipe is interrupted by plastic, non-metallic gaskets, or other insulating materials,

DO NOT use for grounding.

Check with a qualified electrician if you are in doubt as to whether the appliance is properly grounded.

DO NOT modify power supply cord plug. If it does not fit outlet, have a proper outlet installed by a qualified electrician.

DO NOT have a fuse in the neutral or grounding circuit. A fuse in the neutral, or grounding circuit could result in an electrical shock.

DO NOT use an extension cord with this appliance.

Failure to follow these instructions could result in electrical shock, serious injury, or death.

Observe all local governing codes and ordinances. Do not, under any circumstances, remove the power supply cord grounding prong.

NOTE: If codes permit, and a separate grounding wire is used; it is recommended that a qualified electrician determine that the grounding path is adequate and not interrupted by plastic, nonmetallic gaskets, or other insulating materials.

Receptacle wiring

Receptacle wiring should be a minimum of 14 gauge. Use copper wire only. It is your responsibility to provide proper and adequate receptacle wiring, installed by a qualified electrician.

Electrical requirements

A time delay fuse or time delay circuit breaker is also required. A separate circuit, serving only this appliance, **MUST** be provided.

NOTE: for details about the parameters of the electric heating function, see the nameplate on the unit.

2. Information on servicing(For flammable materials)

WARNING:

-Servicing shall only be performed as recommended by the equipment manufacturer. Maintenance and repair requiring the assistance of other skilled personnel shall be carried out under the supervision of the person competent in the use of flammable refrigerants.

-DO NOT modify the length of the power cord or use an extension cord to power the unit.

-DO NOT share a single outlet with other electrical appliances. Improper power supply can cause fire or electrical shock.

-Please follow the instruction carefully to handle, install, clear,

service the appliance to avoid any damage or hazard.

Flammable

Refrigerant R32 is used within appliance.

-When maintaining or disposing the appliance, the refrigerant (R32) shall be recovered properly, shall not discharge to air directly.

-Compliance with national gas regulations shall be observed.

-Keep ventilation openings clear of obstruction.

-The appliance shall be stored so as to prevent mechanical damage from occurring.

-A warning that the appliance shall be stored in a well-ventilated area where the room size corresponds to the room area as specified for operation.

-Any person who is involved with working on or breaking into a refrigerant circuit should hold a current valid certificate from an industry-accredited assessment authority, which authorises their competence to handle refrigerants safely in accordance with an industry recognised assessment specification. All training shall follow the ANNEX HH requirements of UL 60335-2-40.

Examples for such working procedures are:

- breaking into the refrigerating circuit;
- opening of sealed components;
- opening of ventilated enclosures.

-No any open fire or device like switch which may generate spark/arcing shall be around appliance to avoid causing ignition of the flammable refrigerant used. Please follow the instructions carefully when storing or maintaining the

appliance to prevent mechanical damage from occurring.

-Do not use means to accelerate the defrosting process or to clean, other than those recommended by the manufacturer.

-The appliance shall be stored in a room without continuously operating ignition sources (for example: open flames, an operating gas appliance) and ignition sources or (for example: an operating electric heater) close to the appliance.

-Do not pierce or burn.

-Be aware that the refrigerants may not contain an odour.

2.1 Transport of equipment containing flammable refrigerants

- See transport regulations.

2.2 Marking of equipment using signs

- See local regulations.

2.3 Disposal of equipment using flammable refrigerants

- See national regulations.

2.4 Storage of equipment/appliances

- The storage of equipment should be in accordance with the manufacturer's instructions.

2.5 Storage of packed (unsold) equipment

- Storage package protection should be constructed such that mechanical damage to the equipment inside the package will not cause a leak of the refrigerant charge. The maximum number of pieces of equipment permitted to be stored together will be determined by local regulations.

2.6 Information on servicing

1)Checks to the area

- Prior to beginning work on systems containing flammable refrigerants, safety checks are necessary to ensure that the risk of ignition is minimised. For repair to the refrigerating system, the following precautions shall be complied with prior to conducting work on the system.

2)Work procedure

- Work shall be undertaken under a controlled procedure so as to minimise the risk of a flammable

gas or vapour being present while the work is being performed.

3)General work area

- All maintenance staff and others working in the local area shall be instructed on the nature of work being carried out. Work in confined spaces shall be avoided. The area around the workspace shall be sectioned off. Ensure that the conditions within the area have been made safe by control of flammable material.

4)Checking for presence of refrigerant

- The area shall be checked with an appropriate refrigerating detector prior to and during work, to ensure the technician is aware of potentially flammable atmospheres. Ensure that the leak detection equipment being used is suitable for use with flammable refrigerants, i.e. non-sparking, adequately sealed or intrinsically safe.

5)Presence of fire extinguisher

- If any hot work is to be conducted on the refrigeration equipment or any associated parts, appropriate fire extinguishing equipment shall be available to hand. Have a dry powder or CO₂ fire extinguisher adjacent to the charging area.

6)No ignition sources

- No person carrying out work in relation to a refrigerating system which involves exposing any pipe work that contains or has contained flammable refrigerant shall use any sources of ignition in such a manner that it may lead to the risk of fire or explosion. All possible ignition sources, including cigarette smoking, should be kept sufficiently far away from the site of installation, repairing, removing and disposal, during which flammable refrigerant can possibly be released to the surrounding space. Prior to work taking place, the area around the equipment is to be surveyed to make sure that there are no flammable hazards or ignition risks. No Smoking signs shall be displayed.

7)ventilated area

- Ensure that the area is in the open or that it is adequately ventilated before breaking into the system or conducting any hot work. A degree of ventilation shall continue during the period that the work is carried out. The ventilation should safely disperse any released refrigerant and preferably expel it externally into the atmosphere.

8)Checks to the refrigerating equipment

- Where electrical components are being changed, they shall be fit for the purpose and to the correct specifications. At all times the manufacturer's

maintenance and service guidelines shall be followed. If in doubt consult the manufacturer's technical department for assistance. The following checks shall be applied to installations using flammable refrigerants: the actual refrigerant charge is in accordance with the room size within which the refrigerant containing parts are installed; the ventilation machinery and outlets are operating adequately and are not obstructed; if an indirect refrigerating circuit is being used, the secondary circuit shall be checked for the presence of refrigerant; marking to the equipment continues to be visible and legible. markings and signs that are illegible shall be corrected; and refrigerating pipe or components are installed in a position where they are unlikely to be exposed to any substance which may corrode refrigerant containing components, unless the components are constructed of materials which are inherently resistant to being corroded or are suitably protected against being so corroded.

9)Checks to electrical devices

- Repair and maintenance to electrical components shall include initial safety checks and component inspection procedures. If a fault exists that could compromise safety, then no electrical supply shall be connected to the circuit until it is satisfactorily dealt with. If the fault cannot be corrected immediately but it is necessary to continue operation, an adequate temporary solution shall be used. This shall be reported to the owner of the equipment so all parties are advised.
- Initial safety checks shall include:
- That capacitors are discharged: this shall be done in a safe manner to avoid possibility of sparking; that there are no live electrical components and wiring are exposed while charging, recovering or purging the system; that there is continuity of earth bonding.

2.7 Repairs to sealed components

1)During repairs to sealed components, all electrical supplies shall be disconnected from the equipment being worked upon prior to any removal of sealed covers, etc. If it is absolutely necessary to have an electrical supply to equipment during servicing, then a permanently operating form of leak detection shall be located at the most critical point to warn of a potentially hazardous situation.

2)Particular attention shall be paid to the following to ensure that by working on electrical components, the casing is not altered in such a way that the level of protection is affected.

- This shall include damage to cables, excessive number of connections, terminals not made to original specification, damage to seals, incorrect fitting of glands, etc.

- Ensure that apparatus is mounted securely.
- Ensure that seals or sealing materials have not degraded such that they no longer serve the purpose of preventing the ingress of flammable atmospheres. Replacement parts shall be in accordance with the manufacturer's specifications.

NOTE: The use of silicon sealant may inhibit the effectiveness of some types of leak detection equipment. Intrinsically safe components do not have to be isolated prior to working on them.

2.8 Repair to intrinsically safe components

Do not apply any permanent inductive or capacitance loads to the circuit without ensuring that this will not exceed the permissible voltage and current permitted for the equipment in use. Intrinsically safe components are the only types that can be worked on while live in the presence of a flammable atmosphere. The test apparatus shall be at the correct rating. Replace components only with parts specified by the manufacturer. Other parts may result in the ignition of refrigerant in the atmosphere from a leak.

2.9 Cabling

Check that cabling will not be subject to wear, corrosion, excessive pressure, vibration, sharp edges or any other adverse environmental effects. The check shall also take into account the effects of aging or continual vibration from sources such as compressors or fans.

2.10 Detection of flammable refrigerants

Under no circumstances shall potential sources of ignition be used in the searching for or detection of refrigerant leaks. A halide torch (or any other detector using a naked flame) shall not be used.

The following leak detection methods are deemed acceptable for systems containing flammable refrigerants. Electronic leak detectors shall be used to detect flammable refrigerants, but the sensitivity may not be adequate, or may need re-calibration. (Detection equipment shall be calibrated in a refrigerant-free area.) Ensure that the detector is not a potential source of ignition and is suitable for the refrigerant used. Leak detection equipment shall be set at a percentage of the LFL of the refrigerant and shall be calibrated to the refrigerant employed and the appropriate percentage of gas (25% maximum) is confirmed. Leak detection fluids are suitable for use with most refrigerants but the use of detergents containing chlorine shall be avoided as the chlorine may react with the refrigerant and corrode the copper pipe-work.

If a leak is suspected, all naked flames shall be removed/

extinguished. If a leakage of refrigerant is found which requires brazing, all of the refrigerant shall be recovered from the system, or isolated (by means of shut of valves) in a part of the system remote from the leak. Removal of refrigerant shall be according to Removal and evacuation.

2.11 Removal and evacuation

When breaking into the refrigerant circuit to make repairs—or for any other purpose - conventional procedures shall be used. However, for flammable refrigerants it is important that best practice be followed, since flammability is a consideration. The following procedure shall be adhered to:

- a) safely remove refrigerant following local and national regulations;
- b) purge the circuit with inert gas;
- c) evacuate (optional for A2L);
- d) purge with inert gas (optional for A2L);
- e) open the circuit by cutting or brazing.

The refrigerant charge shall be recovered into the correct recovery cylinders if venting is not allowed by local and national codes. For appliances containing flammable refrigerants, the system shall be purged with oxygen-free nitrogen to render the appliance safe for flammable refrigerants. This process might need to be repeated several times. Compressed air or oxygen shall not be used for purging refrigerant systems. For appliances containing flammable refrigerants, refrigerants purging shall be achieved by breaking the vacuum in the system with oxygen-free nitrogen and continuing to fill until the working pressure is achieved, then venting to atmosphere, and finally pulling down to a vacuum (optional for A2L). This process shall be repeated until no refrigerant is within the system (optional for A2L). When the final oxygen-free nitrogen charge is used, the system shall be vented down to atmospheric pressure to enable work to take place. Ensure that the outlet for the vacuum pump is not close to any potential ignition sources and that ventilation is available.

2.12 Charging procedures

In addition to conventional charging procedures, the following requirements shall be followed. Ensure that contamination of different refrigerants does not occur when using charging equipment. Hoses or lines shall be as short as possible to minimise the amount of refrigerant contained in them. Cylinders shall be kept in an appropriate position according to the instructions. Ensure that the refrigeration system is earthed prior to charging the system with refrigerant. Label the system when

charging is complete (if not already). Extreme care shall be taken not to overfill the refrigeration system. Prior to recharging the system it shall be pressure tested with OFN. The system shall be leak tested on completion of charging but prior to commissioning. A follow up leak test shall be carried out prior to leaving the site.

2.13 Decommissioning

Before carrying out this procedure, it is essential that the technician is completely familiar with the equipment and all its detail. It is recommended good practice that all refrigerants are recovered safely. Prior to the task being carried out, an oil and refrigerant sample shall be taken in case analysis is required prior to re-use of reclaimed refrigerant. It is essential that electrical power is available before the task is commenced.

- a) Become familiar with the equipment and its operation.
 - b) Isolate system electrically.
 - c) Before attempting the procedure ensure that: Mechanical handling equipment is available, if required, for handling refrigerant cylinders;
- All personal protective equipment is available and being used correctly; The recovery process is supervised at all times by a competent person; Recovery equipment and cylinders conform to the appropriate standards.
- d) Pump down refrigerant system, if possible.
 - e) If a vacuum is not possible, make a manifold so that refrigerant can be removed from various parts of the system.
 - f) Make sure that cylinder is situated on the scales before recovery takes place.
 - g) Start the recovery machine and operate in accordance with instructions.
 - h) Do not overfill cylinders. (No more than 80 % volume liquid charge).
 - i) Do not exceed the maximum working pressure of the cylinder, even temporarily.
 - j) When the cylinders have been filled correctly and the process completed, make sure that the cylinders and the equipment are removed from site promptly and all isolation valves on the equipment are closed of.
 - k) Recovered refrigerant shall not be charged into another refrigeration system unless it has been cleaned and checked.

2.14 Labelling

Equipment shall be labelled stating that it has been de-commissioned and emptied of refrigerant. The label shall

be dated and signed.

Ensure that there are labels on the equipment stating the equipment contains flammable refrigerant.

2.15 Recovery

When removing refrigerant from a system, either for servicing or decommissioning, it is recommended good practice that all refrigerants are removed safely. When transferring refrigerant into cylinders, ensure that only appropriate refrigerant recovery cylinders are employed.

Ensure that the correct number of cylinders for holding the total system charge is available. All cylinders to be used are designated for the recovered refrigerant and labelled for that refrigerant (i.e. special cylinders for the recovery of refrigerant). Cylinders shall be complete with pressure relief valve and associated shut-of valves in good working order. Empty recovery cylinders are evacuated and, if possible, cooled before recovery occurs.

The recovery equipment shall be in good working order with a set of instructions concerning the equipment that is at hand and shall be suitable for the recovery of flammable refrigerants. In addition, a set of calibrated weighing scales shall be available and in good working order. Hoses shall be complete with leak-free disconnect couplings and in good condition. Before using the recovery machine, check that it is in satisfactory working order, has been properly maintained and that any associated electrical components are sealed to prevent ignition in the event of a refrigerant release. Consult manufacturer if in doubt. The recovered refrigerant shall be returned to the refrigerant supplier in the correct recovery cylinder, and the relevant Waste Transfer Note arranged.

Do not mix refrigerants in recovery units and especially not in cylinders. If compressors or compressor oils are to be removed, ensure that they have been evacuated to an acceptable level to make certain that flammable refrigerant does not remain within the lubricant. The evacuation process shall be carried out prior to returning the compressor to the suppliers. Only electric heating to the compressor body shall be employed to accelerate this process. When oil is drained from a system, it shall be carried out safely.

Non-duct connected appliances containing A2L refrigerants with the supply and return air openings in the conditioned space may have the body of the appliance may be installed in open areas such as false ceilings not being used as return air plenums, as long as the conditioned air does not directly communicate with the air of the false ceiling.

Specifications

Contents

1.	Model Reference.....	2
2.	Nomenclature	3
3.	Specifications.....	4
4.	Unit Components	12
5.	Dimension	13
6.	Refrigerant Cycle Diagrams.....	14
7.	Electrical Wiring Diagrams	15
8.	PCB Printed Diagrams	16

1. Model Reference

Unit Model	Capacity (Btu/h)	Power Supply
PTAC07H352-KC-3	7k	208/230V / 60Hz / 1Phase
PTAC09H352-KC-3	9k	
PTAC12H352-KC-3	12k	
PTAC15H352-KC-3	15k	
PTAC15H502-KC-3	15k	
PTAC07H352-KC-3	7k	
PTAC09H352-KC-3	9k	
PTAC12H352-KC-3	12k	
PTAC15H352-KC-3	15k	
PTAC15H502-KC-3	15k	
PTHP07H353-KC-3	7k	265V / 60Hz / 1Phase
PTHP09H353-KC-3	9k	
PTHP12H353-KC-3	12k	
PTHP15H353-KC-3	15k	
PTHP15H503-KC-3	15k	

2. Nomenclature

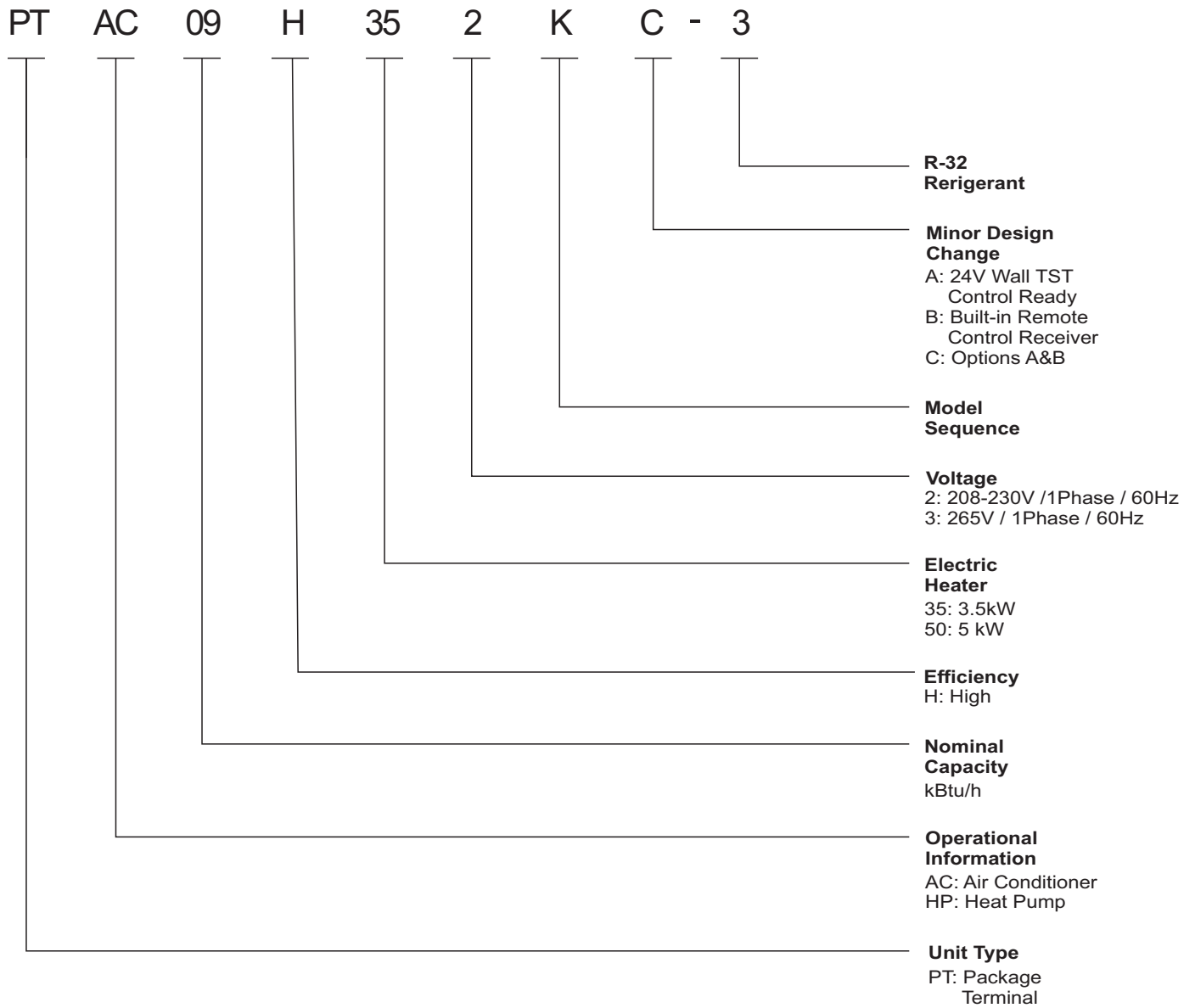

3. Specifications

Model		PTAC07H235-KC-3	
Power supply (Indoor)		V- Ph-Hz	208/230-1-60
Starting current		A	33.9
Compressor	Model	KSN54N11UAJB3	
	Type	ROTARY	
	Brand	GMCC	
	Capacity	W	1565/1610
	Input	W	575/580
	Rated current	A	2.75/2.45
	Locked rotor Amp(LRA)	A	14
	Thermal protector	USP-233-05	
	Thermal protector position	INTERNAL	
	Capacitor	uF	15
	Refrigerant oil/oil charge	ml	VG68 190±10
Indoor side fan motor(DC)	Model	ZKFP-25-8-157L	
	Speed(hi/mi/lo)	r/min	Cool 930/800 Heat 1040/940
	Insulation class	B	
	Waterproofing class	IP20	
Outdoor side fan motor	Model	YKT-58-4-3L	
	Input	W	87
	Capacitor	uF	3uF
	Speed(hi/mi/lo)	r/min	1580
	Capacitor class	S3	
	Insulation class	B	
Indoor air flow (Hi/Mi/Lo)		m ³ /h	588/0/484
		ft ³ /min	345.88//284.71
Indoor sound pressure level Hi/Mi/Lo)		dB(A)	51/0/50.5
Outdoor side noise level(Hi)		dB(A)	67
Refrigerant type		Type	R32
		kg	0.49
		oz	17.28
Design pressure(145psi=1MPa)(L/H)		psi	300/580
Power wiring		14#x3	
Plug type		LCDI(6-15P)	
Control type		Electronic Control	
Operation temp	indoor(cooling/heating)	°C	17-32/0-27
		°F	62.6-89.6/32-80.6
	outdoor(cooling/heating)	°C	18-43/-5-24
		°F	64.4-109.4/23-75.2
Dimension(W*D*H)		mm	1067x532x406
		in	42.01x20.94x15.98
Packing (W*D*H)		mm	1130x625x490
		in	44.49x24.61x19.29
Net/Gross weight		kg	44.5/48.5
		lb	98.10/106.92
Qty/per 20' /40' /40'HQ		Pieces	72/152/190

Notes:

1) Capacities are based on the following conditions:

Cooling: - Indoor Temperature 26.7°C(80°F) DB /19.4 °C(67°F) WB Heating: - Indoor Temperature 21.1°C(70°F) DB / 15.6°C(60°F) WB
 -Outdoor Temperature 35 °C(95°F) DB /23.9 °C(75°F) WB -Outdoor Temperature 8.3°C(47°F) DB / 6.1°C(43°F) WB

2) Capacities are Net Capacities.

3) Due to our policy of innovation some specifications may be changed without notification.

Model		PTAC09H352-KC-3	
Power supply (Indoor)		V- Ph-Hz	208/230-1-60
Starting current		A	45.9
Compressor	Model		KSN71N11VDZ1
	Type		ROTARY
	Brand		GMCC
	Capacity	W	2560/2525
	Input	W	630/626
	Rated current	A	2.98/2.72
	Locked rotor Amp(LRA)	A	17
	Thermal protector		UP3-A0L/HPA-318L
	Thermal protector position		INTERNAL
	Capacitor	uF	20
	Refrigerant oil/oil charge	ml	VG68 190
Indoor side fan motor(DC)	Model		ZKFP-25-8-157L
	Speed(hi/mi/lo)	r/min	Cool 1110/930 Heat 1110/1020
	Insulation class		B
	Waterproofing class		IP20
Outdoor side fan motor	Model		YKT-37-4-203L
	Input	W	71
	Capacitor	uF	3
	Speed(hi/mi/lo)	r/min	1365
	Capacitor class		S3
	Insulation class		B
Indoor air flow (Hi/Mi/Lo)		m3/h	731/0/582
		ft3/min	430.00//342.35
Indoor sound pressure level Hi/Mi/Lo)		dB(A)	50/0/49.5
Outdoor side noise level(Hi)		dB(A)	63
Refrigerant type		Type	R32
		kg	0.43
		oz	15.16782
Design pressure(145psi=1MPa)(L/H)		psi	300/580
Power wiring			12#x3
Plug type			LCDI(6-20P)
Control type			Electronic Control
Operation temp	indoor(cooling/heating)	°C	17-32/0-27
		°F	62.6-89.6/32-80.6
	outdoor(cooling/heating)	°C	18-43/-5-24
		°F	64.4-109.4/23-75.2
Dimension(W*D*H)		mm	1067x532x406
		in	42.01x20.94x15.98
Packing (W*D*H)		mm	1130x625x490
		in	44.49x24.61x19.29
Net/Gross weight		kg	44/48
		lb	97.00/105.82
Qty' per 20' /40' /40' HQ		Pieces	72/152/190

Notes:

1) Capacities are based on the following conditions:

Cooling: - Indoor Temperature 26.7°C(80°F) DB /19.4 °C(67°F) WB Heating: - Indoor Temperature 21.1°C(70°F) DB / 15.6°C(60°F) WB
 -Outdoor Temperature 35 °C(95°F) DB /23.9 °C(75°F) WB -Outdoor Temperature 8.3°C(47°F) DB / 6.1°C(43°F) WB

2) Capacities are Net Capacities.

3) Due to our policy of innovation some specifications may be changed without notification.

Model			PTAC07H352-KC-3	PTAC09H352-KC-3
Power supply (Indoor)		V- Ph-Hz	208/230-1-60	208/230-1-60
Starting current		A	33.9	45.9
Compressor	Model		KSN54N11UAJB3	KSN82N13VDZB1
	Type		ROTARY	ROTARY
	Brand		GMCC	GMCC
	Capacity	W	1565/1610	2970/3015 ±3% W
	Input	W	575/580	710/718 ±3% W
	Rated current	A	2.75/2.45	3.45/3.15 ±3% A
	Locked rotor Amp(LRA)	A	14	20
	Thermal protector		USP-233-05	/
	Thermal protector position		INTERNAL	INTERNAL
	Capacitor	uF	15	20
	Refrigerant oil/oil charge	ml	VG68 190±10	ESTER OIL VG68-270±10 ml
Indoor side fan motor(DC)	Model		ZKFP-25-8-157L	ZKFP-25-8-157L
	Speed(hi/mi/lo)	r/min	Cool 930/800 Heat 1040/940	Cool 930/800 Heat 1110/1020
	Insulation class		B	B
	Waterproofing class		IP20	IP20
Outdoor side fan motor	Model		YKT-58-4-3L	YKT-37-4-203L
	Input	W	87	71
	Capacitor	uF	3	3
	Speed(hi/mi/lo)	r/min	1580	1365
	Capacitor class		S3	S3
	Insulation class		B	B
Indoor air flow (Hi/Mi/Lo)		m3/h	603/0/502	617/0/510
		ft3/min	354.71///295.29	362.94///300.00
Indoor sound pressure level Hi/Mi/Lo)		dB(A)	51/0/50.5	50/0/49.5
Outdoor side noise level(Hi)		dB(A)	67	64
Refrigerant type		Type	R32	R32
		kg	0.68	0.43
		oz	23.98632	15.16782
Design pressure(145psi=1MPa)(L/H)		psi	300/580	300/580
Power wiring			14#x3	12#x3
Plug type			LCDI(6-15P)	LCDI(6-20P)
Control type			Electronic Control	Electronic Control
Operation temp	indoor(cooling/heating)	°C	17-32/0-27	17-32/0-27
		°F	62.6-89.6/32-80.6	62.6-89.6/32-80.6
	outdoor(cooling/heating)	°C	18-43/-5-24	18-43/-5-24
		°F	64.4-109.4/23-75.2	64.4-109.4/23-75.2
Dimension(W*D*H)		mm	1067x532x406	1067x532x406
		in	42.01x20.94x15.98	42.01x20.94x15.98
Packing (W*D*H)		mm	1130x625x490	1130x625x490
		in	44.49x24.61x19.29	44.49x24.61x19.29
Net/Gross weight		kg	46/50	45/49
		lb	101.41/110.23	99.21/108.03
Qty'per 20' /40' /40'HQ		Pieces	72/152/190	72/152/190

Notes:

1) Capacities are based on the following conditions:

Cooling: - Indoor Temperature 26.7°C(80°F) DB /19.4 °C(67°F) WB
 -Outdoor Temperature 35 °C(95°F) DB /23.9 °C(75°F) WB

Heating: - Indoor Temperature 21.1°C(70°F) DB / 15.6°C(60°F) WB
 -Outdoor Temperature 8.3°C(47°F) DB / 6.1°C(43°F) WB

2) Capacities are Net Capacities.

3) Due to our policy of innovation some specifications may be changed without notification.

Model		PTAC12H352-KC-3	
Power supply (Indoor)		V- Ph-Hz	208/230-1-60
Starting current		A	45.9
Compressor	Model		KSM100N11VEZ
	Type		ROTARY
	Brand		GMCC
	Capacity	W	3590/3620
	Input	W	850/875±3%
	Rated current	A	4.18/3.85±3%
	Locked rotor Amp(LRA)	A	28.5±10%
	Thermal protector		UP-A2H/HPA-325H
	Thermal protector position		INTERNAL
	Capacitor	uF	35
	Refrigerant oil/oil charge	ml	VG68 300±15
Indoor side fan motor(DC)	Model		ZKFP-25-8-157L
	Speed(hi/mi/lo)	r/min	Cool 1110/930 Heat 1110/1020
	Insulation class		B
	Waterproofing class		IP20
Outdoor side fan motor	Model		YKT-58-4-3L
	Input	W	87
	Capacitor	uF	3
	Speed(hi/mi/lo)	r/min	1580
	Capacitor class		S3
	Insulation class		B
Indoor air flow (Hi/Mi/Lo)		m3/h	733/0/592
		ft3/min	431.18//348.24
Indoor sound pressure level Hi/Mi/Lo)		dB(A)	52/0/51.5
Outdoor side noise level(Hi)		dB(A)	67
Refrigerant type		Type	R32
		kg	0.43
		oz	15.16782
Design pressure(145psi=1MPa)(L/H)		psi	300/580
Power wiring			12#x3
Plug type			LCDI(6-20P)
Control type			Electronic Control
Operation temp	indoor(cooling/heating)	°C	17-32/0-27
		°F	62.6-89.6/32-80.6
	outdoor(cooling/heating)	°C	18-43/-5-24
		°F	64.4-109.4/23-75.2
Dimension(W*D*H)		mm	1067x532x406
		in	42.01x20.94x15.98
Packing (W*D*H)		mm	1130x625x490
		in	44.49x24.61x19.29
Net/Gross weight		kg	47/51
		lb	103.62/112.43
Qty' per 20' /40' /40'HQ		Pieces	72/152/190

Notes:

1) Capacities are based on the following conditions:

Cooling: - Indoor Temperature 26.7°C(80°F) DB /19.4 °C(67°F) WB Heating: - Indoor Temperature 21.1°C(70°F) DB / 15.6°C(60°F) WB
 -Outdoor Temperature 35 °C(95°F) DB /23.9 °C(75°F) WB -Outdoor Temperature 8.3°C(47°F) DB / 6.1°C(43°F) WB

2) Capacities are Net Capacities.

3) Due to our policy of innovation some specifications may be changed without notification.

Model		PTAC12H352-KC-3	
Power supply (Indoor)		V- Ph-Hz	208/230-1-60
Starting current		A	45.9
Compressor	Model		KSM100N11VEZ
	Type		ROTARY
	Brand		GMCC
	Capacity	W	3590/3620
	Input	W	850/875±3%
	Rated current	A	4.18/3.85±3%
	Locked rotor Amp(LRA)	A	28.5±10%
	Thermal protector		UP-A2H/HPA-325H
	Thermal protector position		INTERNAL
	Capacitor	uF	35
	Refrigerant oil/oil charge	ml	VG68 300±15
Indoor side fan motor(DC)	Model		ZKFP-25-8-157L
	Speed(hi/mi/lo)	r/min	Cool 1110/930 Heat 1110/1020
	Insulation class		B
	Waterproofing class		IP20
Outdoor side fan motor	Model		YKT-58-4-3L
	Input	W	87
	Capacitor	uF	3
	Speed(hi/mi/lo)	r/min	1580
	Capacitor class		S3
Indoor air flow (Hi/Mi/Lo)		m3/h	745/0/585
		ft3/min	438.24//344.12
Indoor sound pressure level Hi/Mi/Lo)		dB(A)	52/0/51.5
Outdoor side noise level(Hi)		dB(A)	67
Refrigerant type	Type		R32
	kg		0.76
	oz		26.80824
Design pressure(145psi=1MPa)(L/H)		psi	300/580
Power wiring			12#x3
Plug type			LCDI(6-20P)
Control type			Electronic Control
Operation temp	indoor(cooling/heating)	°C	17-32/0-27
		°F	62.6-89.6/32-80.6
	outdoor(cooling/heating)	°C	18-43/-5-24
		°F	64.4-109.4/23-75.2
Dimension(W*D*H)		mm	1067x532x406
		in	42.01x20.94x15.98
Packing (W*D*H)		mm	1130x625x490
		in	44.49x24.61x19.29
Net/Gross weight		kg	50/54
		lb	110.23/119.05
Qty' per 20' /40' /40'HQ		Pieces	72/152/190

Notes:

1) Capacities are based on the following conditions:

Cooling: - Indoor Temperature 26.7°C(80°F) DB /19.4 °C(67°F) WB
 -Outdoor Temperature 35 °C(95°F) DB /23.9 °C(75°F) WB

Heating: - Indoor Temperature 21.1°C(70°F) DB / 15.6°C(60°F) WB
 -Outdoor Temperature 8.3°C(47°F) DB / 6.1°C(43°F) WB

2) Capacities are Net Capacities.

3) Due to our policy of innovation some specifications may be changed without notification.

Model			PTAC15H352-KC-3	PTAC15H352-KC-3
Power supply (Indoor)		V- Ph-Hz	208/230-1-60	208/230-1-60
Starting current		A	45.9	45.9
Compressor	Model		KSM125N1UEZ	KSM125N1UEZ
	Type		ROTARY	ROTARY
	Brand		GMCC	GMCC
	Capacity	W	3825±3%	3825±3%
	Input	W	1300±3%	1300±3%
	Rated current	A	6.35	6.35
	Locked rotor Amp(LRA)	A	(at 1Ph-240V-60Hz)34.5 ±10% A	(at 1Ph-240V-60Hz)34.5 ±10% A
	Thermal protector		HPA-430KH	HPA-430KH
	Thermal protector position		INTERNAL	INTERNAL
	Capacitor	uF	60	60
	Refrigerant oil/oil charge	ml	VG68-300±15 ml	VG68-300±15 ml
Indoor side fan motor(DC)	Model		ZKFP-25-8-157L	ZKFP-25-8-157L
	Speed(hi/mi/lo)	r/min	Cool 1100/930;Heat 1100/1020	Cool 1100/930;Heat 1100/1020
	Insulation class		B	B
	Waterproofing class		IP20	IP20
Outdoor side fan motor	Model		YKT-58-4-3L	YKT-58-4-3L
	Input	W	87	87
	Capacitor	uF	3	3
	Speed(hi/mi/lo)	r/min	1580	1580
	Capacitor class		S3	S3
	Insulation class		B	B
Indoor air flow (Hi/Mi/Lo)		m3/h	731/0/594	708/0/561
		ft3/min	430.00//349.41	416.47//330.00
Indoor sound pressure level Hi/Mi/Lo)		dB(A)	51/0/50.5	53/0/52.5
Outdoor side noise level(Hi)		dB(A)	65	67
Refrigerant type		Type	R32	R32
		kg	0.61	0.9
		oz	21.51714	31.7466
Design pressure(145psi=1MPa)(L/H)		psi	300/580	300/580
Power wiring			12#x3	12#x3
Plug type			LCDI(6-20P)	LCDI(6-20P)
Control type			Electronic Control	Electronic Control
Operation temp	indoor(cooling/heating)	°C	17-32/0-27	17-32/0-27
		°F	62.6-89.6/32-80.6	62.6-89.6/32-80.6
	outdoor(cooling/heating)	°C	18-43/-5-24	18-43/-5-24
		°F	64.4-109.4/23-75.2	64.4-109.4/23-75.2
Dimension(W*D*H)		mm	1067x532x406	1067x532x406
		in	42.01x20.94x15.98	42.01x20.94x15.98
Packing (W*D*H)		mm	1130x625x490	1130x625x490
		in	44.49x24.61x19.29	44.49x24.61x19.29
Net/Gross weight		kg	48/52	51.5/55.5
		lb	105.82/114.64	113.54/122.36
Qty'per 20' /40' /40'HQ		Pieces	72/152/190	72/152/190

Notes:

1) Capacities are based on the following conditions:

Cooling: - Indoor Temperature 26.7°C(80°F) DB /19.4 °C(67°F) WB
 -Outdoor Temperature 35 °C(95°F) DB /23.9 °C(75°F) WB

Heating: - Indoor Temperature 21.1°C(70°F) DB / 15.6°C(60°F) WB
 -Outdoor Temperature 8.3°C(47°F) DB / 6.1°C(43°F) WB

2) Capacities are Net Capacities.

3) Due to our policy of innovation some specifications may be changed without notification.

Model			PTHP07H353-KC-3	PTHP09H353-KC-3
Power supply (Indoor)		V- Ph-Hz	265-1-60	265-1-60
Starting current		A	39.6	39.6
Compressor	Model		KSN54U11UAJB3	KSN71U11VDZ1
	Type		ROTARY	ROTARY
	Brand		GMCC	GMCC
	Capacity	W	1620	2565±3%
	Input	W	585	645±3%
	Rated current	A	2.22	2.45±3%
	Locked rotor Amp(LRA)	A	11	(at 1Ph-277V-60Hz)16 ±10% A
	Thermal protector		URP-267-05/HPA-315	HRP-267-05/HPA-315
	Thermal protector position		INTERNAL	INTERNAL
	Capacitor	uF	10	15
	Refrigerant oil/oil charge	ml	VG68 / 190ml	VG68-190±10 ml
Indoor side fan motor(DC)	Model		ZKFP-25-8-157L	ZKFP-25-8-157L
	Speed(hi/mi/lo)	r/min	Cool 1040/900;Heat 1060/940	Cool 1040/900;Heat 1040/940
	Insulation class		B	B
	Waterproofing class		IP20	IP20
Outdoor side fan motor	Model		YKT-37-4-6	YKT-37-4-6
	Input	W	71	71
	Capacitor	uF	2	2
	Speed(hi/mi/lo)	r/min	1390	1390
	Capacitor class		S3	S3
	Insulation class		B	B
Indoor air flow (Hi/Mi/Lo)		m3/h	676/0/573	661/0/558
		ft3/min	397.65//337.06	388.82//328.24
Indoor sound pressure level Hi/Mi/Lo)		dB(A)	49.5/0/48	50/0/49.5
Outdoor side noise level(Hi)		dB(A)	64	63
Refrigerant type		Type	R32	R32
		kg	0.5	0.55
		oz	17.637	19.4007
Design pressure(145psi=1MPa)(L/H)		psi	300/580	300/580
Power wiring			14#x3	14#x3
Plug type			LCDI(7-20P)	LCDI(7-20P)
Control type			Electronic Control	Electronic Control
Operation temp	indoor(cooling/heating)	°C	17-32/0-27	17-32/0-27
		°F	62.6-89.6/32-80.6	62.6-89.6/32-80.6
	outdoor(cooling/heating)	°C	18-43/-5-24	18-43/-5-24
		°F	64.4-109.4/23-75.2	64.4-109.4/23-75.2
Dimension(W*D*H)		mm	1067x532x406	1067x532x406
		in	42.01x20.94x15.98	42.01x20.94x15.98
Packing (W*D*H)		mm	1130x625x490	1130x625x490
		in	44.49x24.61x19.29	44.49x24.61x19.29
Net/Gross weight		kg	43/47	45/49
		lb	94.80/103.62	99.21/108.03
Qty'per 20' /40' /40'HQ		Pieces	72/152/190	72/152/190

Notes:

1) Capacities are based on the following conditions:

Cooling: - Indoor Temperature 26.7°C(80°F) DB /19.4 °C(67°F) WB
 -Outdoor Temperature 35 °C(95°F) DB /23.9 °C(75°F) WB

Heating: - Indoor Temperature 21.1°C(70°F) DB / 15.6°C(60°F) WB
 -Outdoor Temperature 8.3°C(47°F) DB / 6.1°C(43°F) WB

2) Capacities are Net Capacities.

3) Due to our policy of innovation some specifications may be changed without notification.

Model			PTHP12H353-KC-3	PTHP15H353-KC-3
Power supply (Indoor)		V- Ph-Hz	265-1-60	265-1-60
Starting current		A	39.6	39.6
Compressor	Model		KSM103U11UFZ	KSM127U1UEZ
	Type		ROTARY	ROTARY
	Brand		GMCC	GMCC
	Capacity	W	3040	3915
	Input	W	1125	1350
	Rated current	A	4.30	5.2
	Locked rotor Amp(LRA)	A	(at 1Ph-60HZ-265V)21 ±10%	28
	Thermal protector		UP3-B1H/HPA-222H	UP3-A2H/HPA-325H
	Thermal protector position		INTERNAL	INTERNAL
	Capacitor	uF	25	30
	Refrigerant oil/oil charge	ml	ESTER OIL VG68 ·300 ·ml±15·ml	VG68 / 300ml
Indoor side fan motor(DC)	Model		ZKFP-25-8-157L	ZKFP-25-8-157L
	Speed(hi/mi/lo)	r/min	Cool 1110/930;Heat 1110/1020	Cool 1110/930;Heat 1150/1020
	Insulation class		B	B
	Waterproofing class		IP20	IP20
Outdoor side fan motor	Model		YKT-58-4-2	YKT-58-4-2
	Input	W	88	88
	Capacitor	uF	2	2
	Speed(hi/mi/lo)	r/min	1590	1590
	Capacitor class		S3	S3
Indoor air flow (Hi/Mi/Lo)		m3/h	738/0/599	738/0/599
		ft3/min	434.12///352.35	434.12///352.35
Indoor sound pressure level Hi/Mi/Lo)		dB(A)	51/0/50.5	51/0/50
Outdoor side noise level(Hi)		dB(A)	66	67.5
Refrigerant type	Type		R32	R32
	kg		0.78	0.9
	oz		27.51372	31.7466
Design pressure(145psi=1MPa)(L/H)		psi	300/580	300/580
Power wiring			14#x3	14#x3
Plug type			LCDI(7-20P)	LCDI(7-20P)
Control type			Electronic Control	Electronic Control
Operation temp	indoor(cooling/heating)	°C	17-32/0-27	17-32/0-27
		°F	62.6-89.6/32-80.6	62.6-89.6/32-80.6
	outdoor(cooling/heating)	°C	18-43/-5-24	18-43/-5-24
		°F	64.4-109.4/23-75.2	64.4-109.4/23-75.2
Dimension(W*D*H)		mm	1067x532x406	1067x532x406
		in	42.01x20.94x15.98	42.01x20.94x15.98
Packing (W*D*H)		mm	1130x625x490	1130x625x490
		in	44.49x24.61x19.29	44.49x24.61x19.29
Net/Gross weight		kg	48/52	49.5/53.5
		lb	105.82/114.64	109.13/117.95
Qty' per 20' /40' /40'HQ		Pieces	72/152/190	72/152/190

Notes:

1) Capacities are based on the following conditions:

Cooling: - Indoor Temperature 26.7°C(80°F) DB /19.4 °C(67°F) WB
 -Outdoor Temperature 35 °C(95°F) DB /23.9 °C(75°F) WB

Heating: - Indoor Temperature 21.1°C(70°F) DB / 15.6°C(60°F) WB
 -Outdoor Temperature 8.3°C(47°F) DB / 6.1°C(43°F) WB

2) Capacities are Net Capacities.

3) Due to our policy of innovation some specifications may be changed without notification.

4. Unit Components

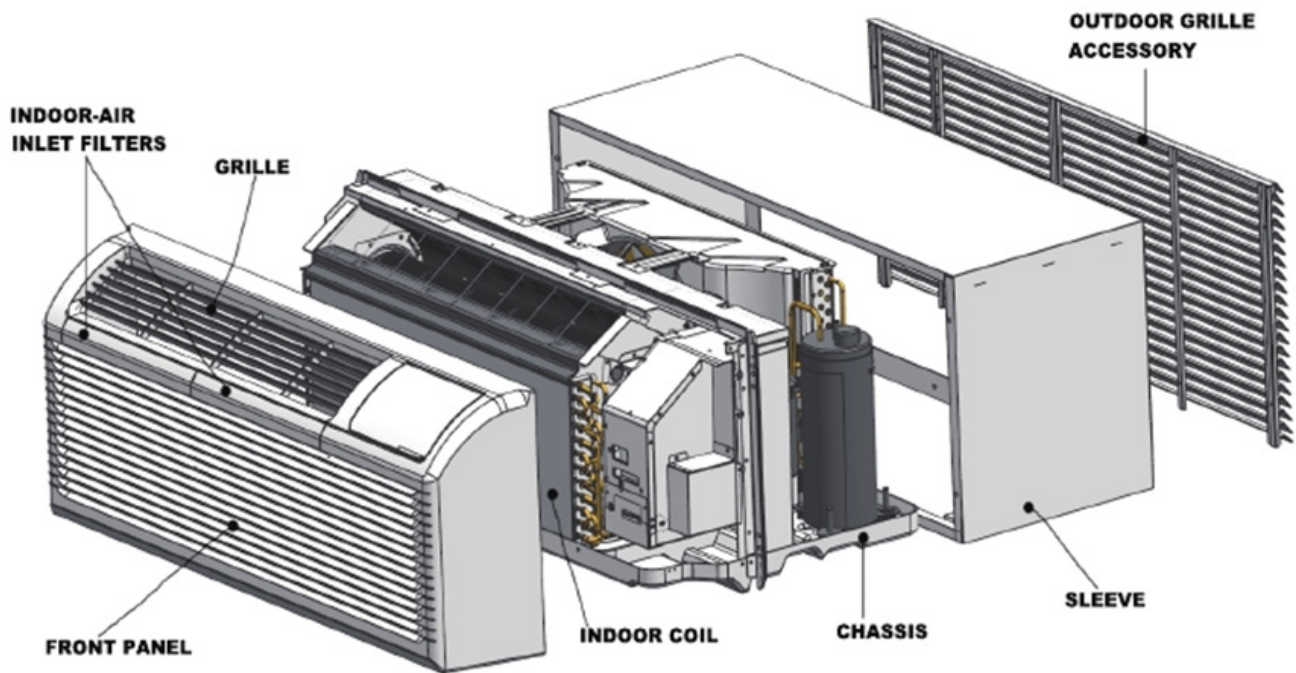

5. Dimension

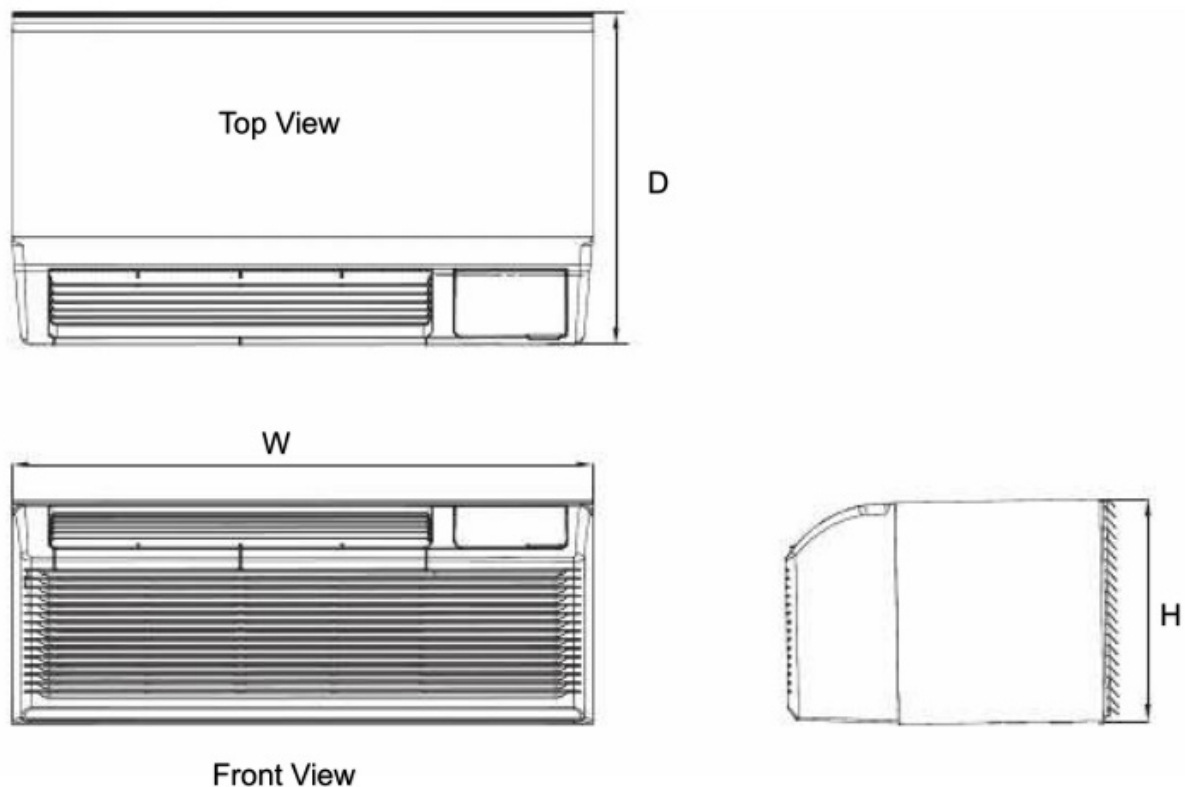

Dimension	WxHxD(mm)
	WxHxD(inch)
Dimension 1 (no sleeve, rear grille and rear net)	1067x406x532
	42.0x15.9x20.9
Dimension 2 (no rear grille and rear net, but include sleeve)	1067x408x578
	42.0x16.0x22.8
Dimension 3 (include sleeve and rear net)	1067x408x588
	42.0x16.0x23.1
Dimension 4 (include sleeve, rear net and rear grille)	1067x408x606
	42.0x16.0x23.9

6. Refrigerant Cycle Diagrams

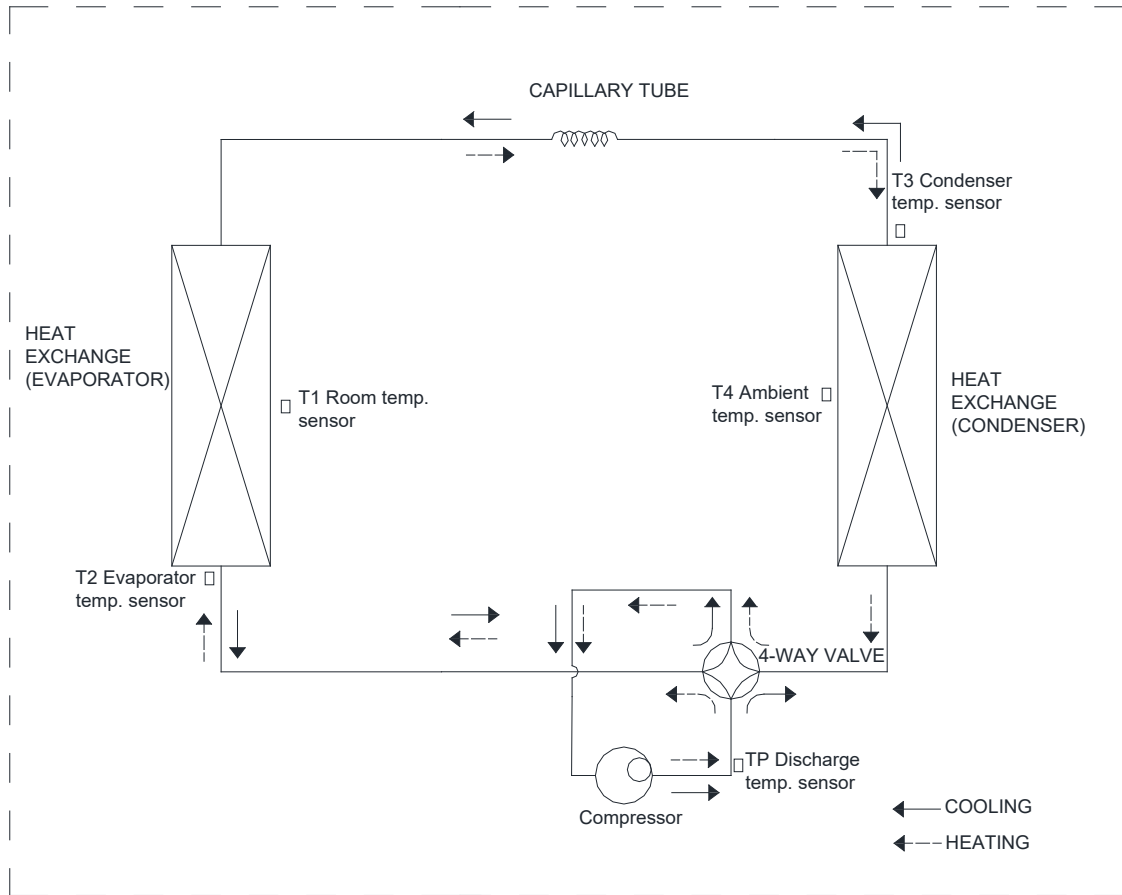

7. Electrical Wiring Diagrams

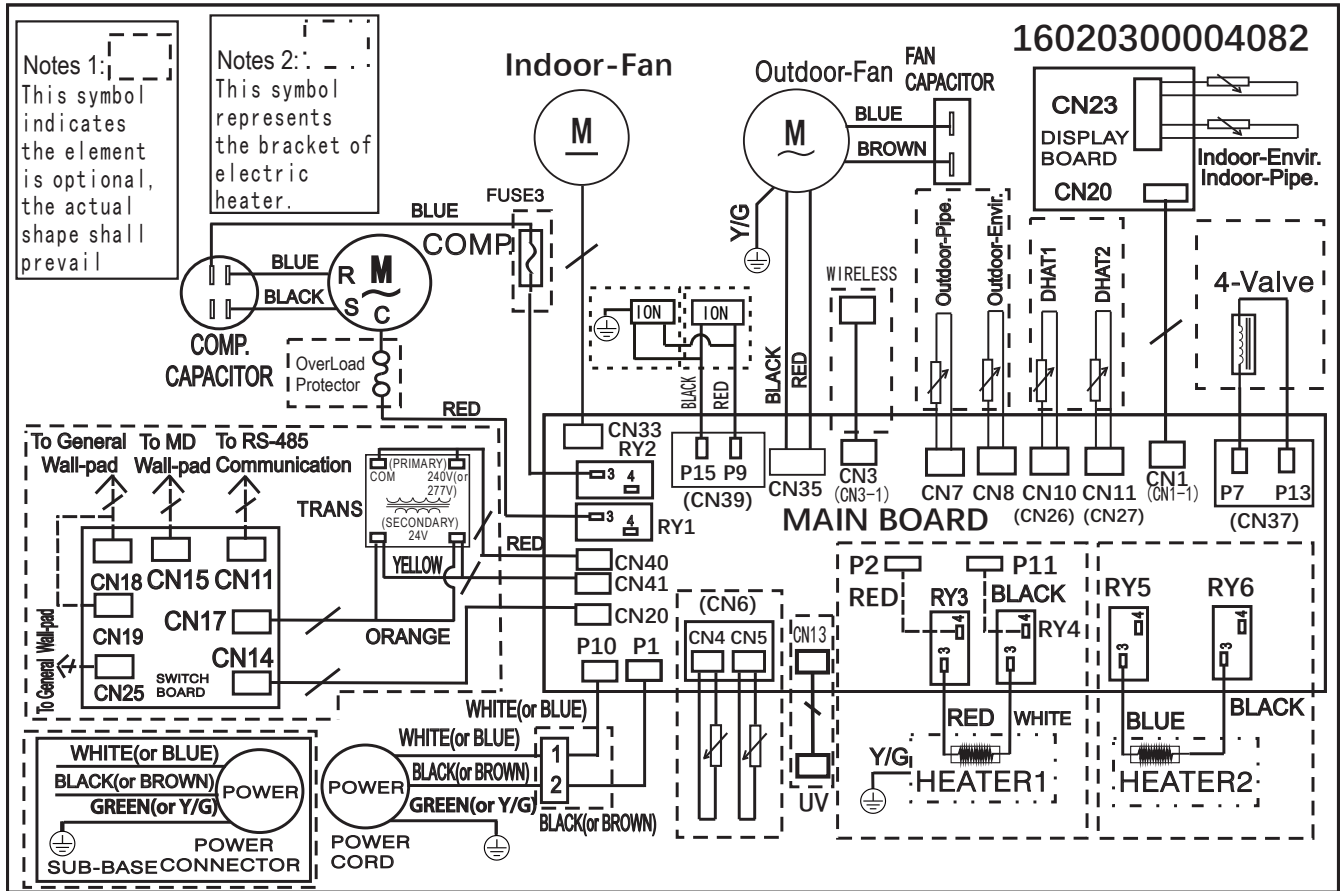

Main control board diagram: 17120300005593

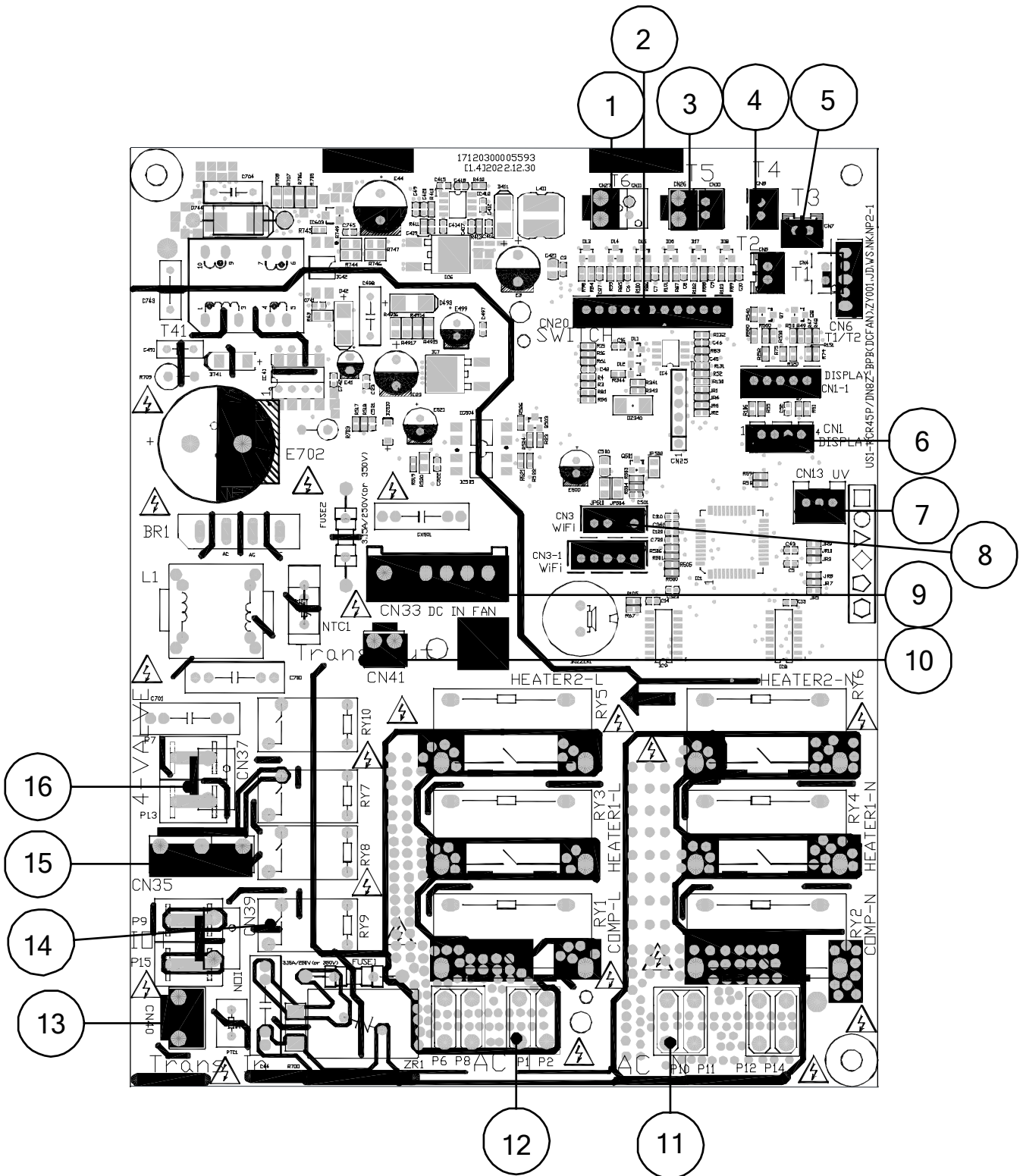

No.	Name	CN#	Meaning
1	T6	CN11(CN27)	connect to discharge temp. sensor T6(Output: 5V DC)
2	SWITCH	CN20	connect to switch(Output:12V DC)
3	T5	CN10(CN26)	connect to discharge temp. sensor T5(Output: 5V DC)
4	T4	CN8	connect to ambient temp. sensor T4(Output: 5V DC)
5	T3	CN7	connect to pipe temp. sensor T3(Output: 5V DC)
6	DISPLAY	CN1(CN1-1)	connect to display board CN20(Output:12V DC)
7	UV	CN13	connect to UV(Output:12V DC)
8	WIFI	CN3(CN3-1)	connect to wireless(Output: 5V DC)
9	DC IN FAN	CN33	connect to indoor fan(Output:310V DC)
10	Trans Out	CN41	connect to transformer(Output:24V AC)
11	AC N	P10	N_in: connect to N-line (208-230V AC input)
12	AC L	P1	L_in: connect to L-line (208-230V AC input)
13	Trans In	CN40	connect to transformer(208-230V AC input)
14	ION	CN39	connect to negative-ion generator(Output:208-230V AC)
15	OUTDOOR FAN	CN35	connect to outdoor fan(Output:208-230V AC)
16	4-WAY	CN37	connect to 4 way valve(Output:208-230V AC)

Note: This section is for reference only. Please take practicality as standard.

Display board diagram: 17120300004053

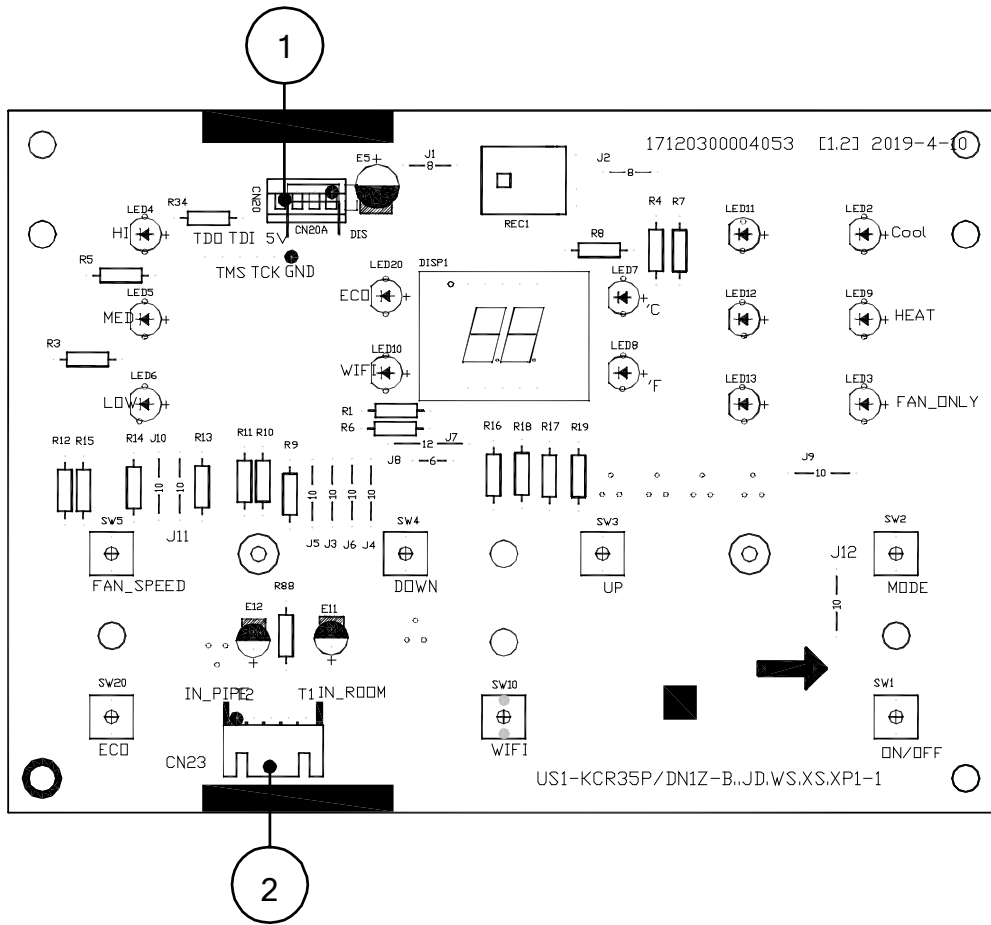

No.	Name	CN#	Meaning
1		CN20	connect to main control board CN1(Output: 5V DC)
2	IN_PIPE, IN_ROOM	CN23	connect to indoor ambient temperature sensor T1, indoor coil temperature sensor T2(Output: 5V DC)

Note: This section is for reference only. Please take practicality as standard.

DIP Switch board diagram: 17122000059328

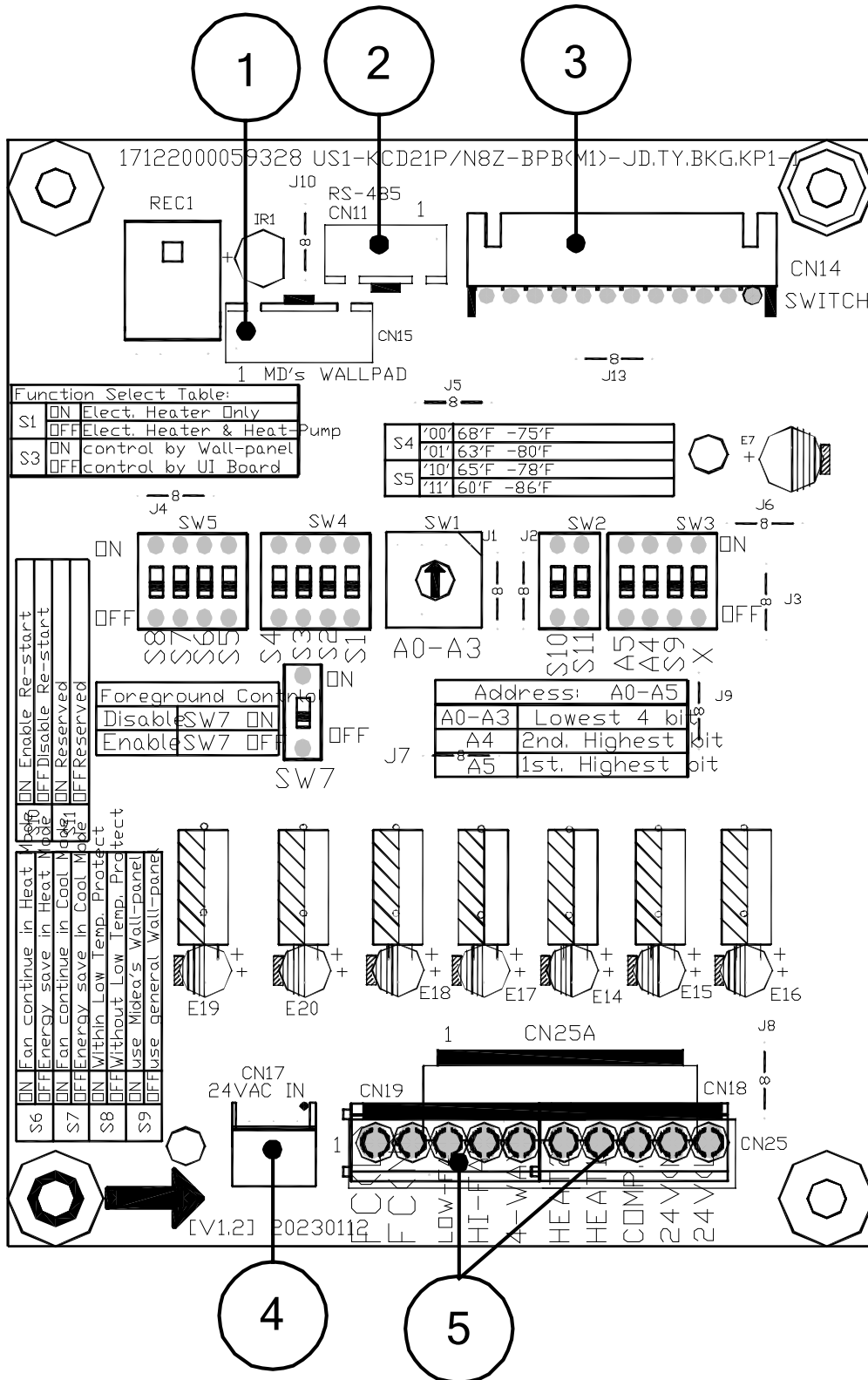

No.	Name	CN#	Meaning
1	MD's WALL PAD	CN15	connect to MD's wall pad(Output:12V or 5V DC)
2	RS-485	CN11	connect to RS485 communication(Output:12V or 5V DC)
3	SWITCH	CN14	connect to main control board CN20(Output:12V DC)
4	24VAC IN	CN17	connect to transformer(24VAC input)
5	24VAC OUT	CN25	connect to general wall pad(Output:24V AC)
		CN19	
		CN18	

Note: This section is for reference only. Please take practicality as standard.

Function and Control Panel

Contents

1. Control Panel	2
2. Safety Features	4
3. Basic Functions	4
3.1 Abbreviation	4
3.2 Fan Mode	4
3.3 Cooling Mode.....	4
3.4 Heating Mode(Heat Pump Units).....	4
3.5 Drying mode.....	5
3.6 DIP Switches Configurations	6
3.7 Dip Switches Configurations By Panel Control(Optional).....	7
3.8 WALL THERMOSTAT TERMINAL (Optional)	8

1. Control Panel

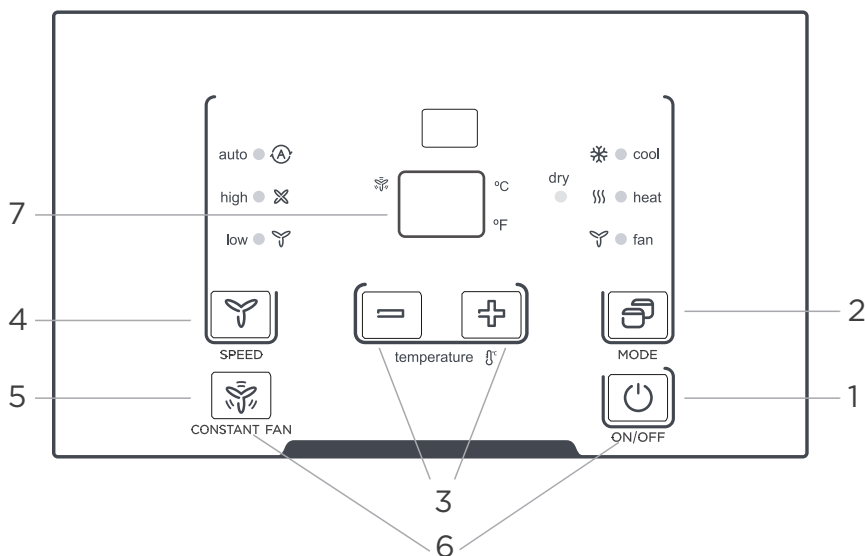

Description	
1	<p>POWER - Function</p> <ul style="list-style-type: none"> · Press the POWER button to turn the unit on or off.
2	<p>Mode - Function</p> <ul style="list-style-type: none"> · Push this button to cycle through the modes from COOL-DRY-HEAT-FAN-COOL.The indicator light beside the “MODE” option will illuminate, identifying the mode selected. · COOL:Cooling begins automatically when the room temperature is above the set point,and stops when the room temperature is 2°C(4°F)below the set point.But the compressor will run 5 minutes at least in COOL mode before stoping. · HEAT:For heat pump models,the unit can alternate to run between in reverse cycle heat mode and electric heater mode according to the diference between the setting temperature andthe room temperature. · The fan motor cycles with the compressor stop. DRY : In this mode, the air conditioner will generally operate in the form of a dehumidifier. Since the conditioned space is a closed or sealed area, some degree of cooling will continue. NOTE: The reverse cycle and electric heater cannot be run at the same time. In following cases, it is normal that the reverse cycle does not operate. 1.When the outdoor temperatrue is lower than 4°C/40°F or the room temperature falls to 4.5°C/8°F below the set point temperature. 2.There is a 3-minute minimum compressor run time at any setting to prevent short cycling. The indoor fan motors starts before the compressor and stops after the compressor cycles off. 3.Push the S1 on the DIP SWITCHES to UP (ON) position. 4.When frost builds up to the evaporator coils,the unit will defrost automatically and the compressor will cycle off. NOTE: When you select AUTO mode, the FAN speed will be automatically adjusted at the setting temperature and room temperature. · FAN: Fan operation only without heating and cooling. NOTE: If the unit has DIP SWITCHES feature,the temperature range can be setted is controlled by DIP SWITCHES.
3	<p>Up and Down buttons</p> <ul style="list-style-type: none"> - Push the UP (or DOWN) button to increase (or decrease) the set temperature of the unit in cooling or heating mode. The temperature can be set by increments of 1°C (1°F).The setting temperature appears in the display. NOTE:Press and hold “+”and“-” buttons together for 3 seconds will alternate the temperature display between°C &°F scale
4	<p>FAN (FAN SPEED) Function</p> <ul style="list-style-type: none"> -Every time you push this button,the fan speed cycles through the settings as follows:AUTO-HIGH-LOW-AUTO. NOTE: When you select AUTO mode, the FAN speed will be automatically adjusted at the setting temperature and room temperature.On Dry mode, the fan speed is controlled at Low speed automatically.

5	CONSTANT FAN-Function	- In cooling mode, press the button to turn on or of the constant fan function. When the function is turned on, the constant fan light will illuminate, identifying the fan continuous run for cooling. When the function is turned off, the constant fan light will go out, identifying the fan cycle run with compressor stop. NOTE: Every time the unit is turned on, the function will work as the DIP SWITCHES CONFIGURATIONS.
6	PANEL LOCKING-Function	-Long press the open key and continuous air function key for 5 seconds at the same time.Quick check immediately response, no 5 seconds.Turn on or of the lock panel function.The remote control still works. Fast entry, and exit when unlocking function. NOTE:It will be display 'LL' when you locked the control panel.
7	DISPLAY	-Shows the set temperature in°C or°F. While on Fan only mode,it shows the room temperature. Control code (on some models): LC - Pads on the control panel is not available.The unit can be setted by using wire cotroller only. FC - Pads on the control panel and wire controller are not available. The unit can be setted by using FRONT DESK CONTROL only. Error codes: E0-Failure of EEPROM parameter E3-The fan stall error E4-Main control and Display communication error AS - Room temperature sensor error; ES - Evaporator temperature sensor error; CS - Condenser temperature sensor error; OS - Outside temperature sensor error; HS - Exhaust temperature sensor error; LE - Wire cotroller error; NOTE:When error occurs,unplug the unit and plug it back in.If error repeats, call for service. Other codes: LO - Room temperature is lower than 0°C/32°F; HI - Room temperature is higher than 37°C/99°F; FP - Low temp. Protection. NOTE: All the illustrations in this manual are for explanation purpose only. Your air conditioner may be slightly diferent. The actual shape shall prevail.

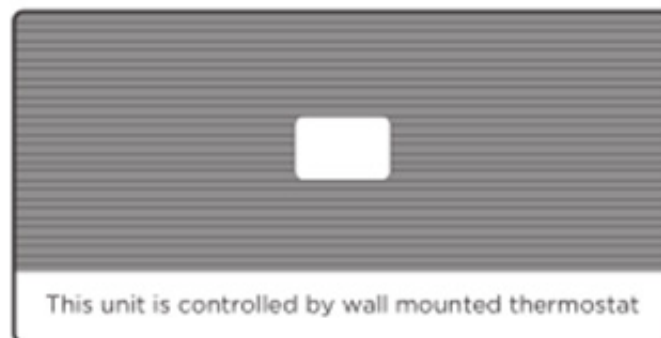

Control panel sticker

NOTE: When the unit displays LC (Pads on the control panel is not available.The unit can be setted by using wire cotroller only). You can install the Accessory on the control panel.

NOTE: For some models, there is corresponding operation happened after 3 seconds when pressing any button.

2. Safety Features

Compressor three-minute delay at restart

The compressor must wait 3 minutes before starting each time.

Sensor redundancy and automatic shutoff

When temperature sensor is malfunctioning, the air conditioner ceases operation.

3. Basic Functions

3.1 Abbreviation

Unit element abbreviations

Abbreviation	Element
TA	Indoor room temperature(T1)
TE	Coil temperature of evaporator(T2)
TC	Coil temperature of condensert(T3)
TO	Outdoor ambient temperature(T4)
TS	Setting temperature
DAHT	Temperature of discharge(T5)
DAHT	Etemperature of discharge(T6)

3.2 Fan Mode

When fan mode is activated:

- Temperature control is disabled, and the room ambient temperature is display on LED.
- The Timer function is valid in this mode.
- Compressor, outdoor fan, electric heater and 4-valve cease operation.

3.3 Cooling Mode

3.3.1 Compressor Control

- The compressor will be activated by sensing the difference between setting temperature and the actual ambient room temperature.
- The compressor operates as below:

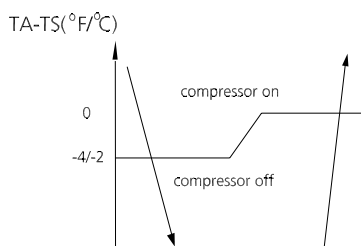

3.3.2 Indoor Fan Control

- 1) In cooling mode, the indoor fan operates continuously. The fan speed can be set to high, low and auto.
- 2) Auto fan

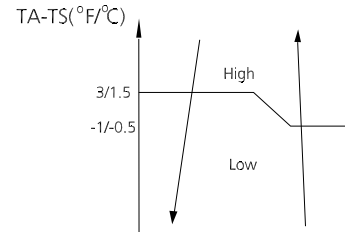

3.3.3 Outdoor Fan Control

- The operation of outdoor fan is consistent with the operation of compressor. (except the T2 low temperature protection).

3.3.4 Evaporator Anti-freezing Protection

- When evaporator temperature drops below 4°F(2°C) last for 240s, the compressor and outdoor fan cease operation.

3.4 Heating Mode(Heat Pump Units)

3.4.1 Compressor Control

- The compressor will be activated by sensing the difference between setting temperature and the actual ambient room temperature.
- The compressor operates as below:

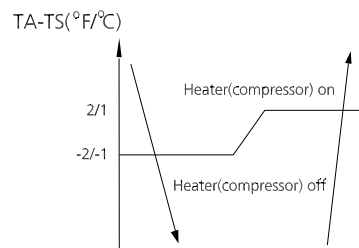

3.4.2 Indoor Fan Control

- 1) In cooling mode, the indoor fan operates continuously. The fan speed can be set to high, low and auto.
- 2) Auto fan

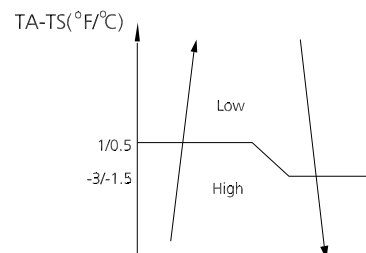

3.4.3 Outdoor Fan Control

- The operation of outdoor fan is consistent with the operation of compressor. (except the T2 low temperature protection).

3.4.4 Evaporator Temperature Protection

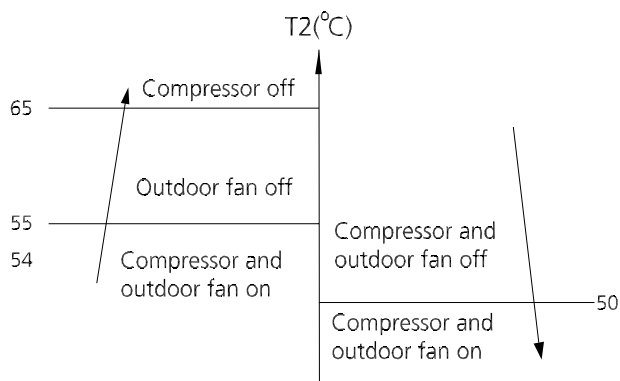

3.4.5 Electric Heater Control

1. When $T_A < T_s - 2^\circ\text{F}(1^\circ\text{C})$, the fan motor operates, and fan speed is higher than 800RPM for 3 seconds, the heater is on and when fan speed is below 700RPM for 3 seconds, the heater is off. The indoor fan operates at low speed within 30 seconds. After 30 seconds, it changes to the setting speed.

2. When $T_A \geq T_s + 2^\circ\text{F}(1^\circ\text{C})$, the heater is off, and the fan motor keeps on working at setting speed. If the DAHT temperature checked is lower than the protection temperature, and the operation time of fan motor is more than 15 seconds, then the fan motor is off.

3. If the DAHT temperature checked is higher than the protection temperature, the heater is off and the fan motor keeps on working. Until the DAHT temperature checked is lower than the protection temperature, the heater is on.

4. If the DAHT temperature sensor is in open circuit or has short circuited, the heater is off and the fan motor is off 30 seconds later.

5. If the ambient temperature sensor is in open circuit or has short circuited, the heater is off and the fan motor is off 30 seconds later.

3.4.6 Heat Pump Control

1. The Heat pump's operation mode is in accordance with the way of compressor's working. The compressor is on (electric heater is off), the fan motor operates according to the anti-cold wind of heat pump. The four-way valve always keeps on. When $T_A < T_s - 2^\circ\text{F}(1^\circ\text{C})$, the compressor is on, and when $T_A \geq T_s + 2^\circ\text{F}(1^\circ\text{C})$, it will be off. Before starting the compressor, the indoor fan motor should run for 10 seconds first. T_A is not judged within 5 minutes after starting the compressor, but it is judged immediately if the set temperature is changed.

2. Anti-cold air function

When the compressor is started, the fan runs at low speed for 3 minutes, then if indoor coil temperature T2 is lower than $80^\circ\text{F}(27^\circ\text{C})$, the fan runs at low speed still, if indoor unit coil temperature T2 is higher than $86^\circ\text{F}(30^\circ\text{C})$, it changes to the setting speed.

3. When the compressor is turned off, when the indoor coil temperature T2 is lower than $80^\circ\text{F}(27^\circ\text{C})$, indoor fan stops running, otherwise the indoor fan runs at low speed, but the longest time is less than 30 seconds.

3.5 Drying mode

- Indoor fan speed is fixed at low and can't be changed.
- Compressor control is the same as in cooling mode.
- All protections are active and the same as that in cooling mode.

3.6 DIP Switches Configurations

Note: Unit must be powered OFF to effectively change their status.

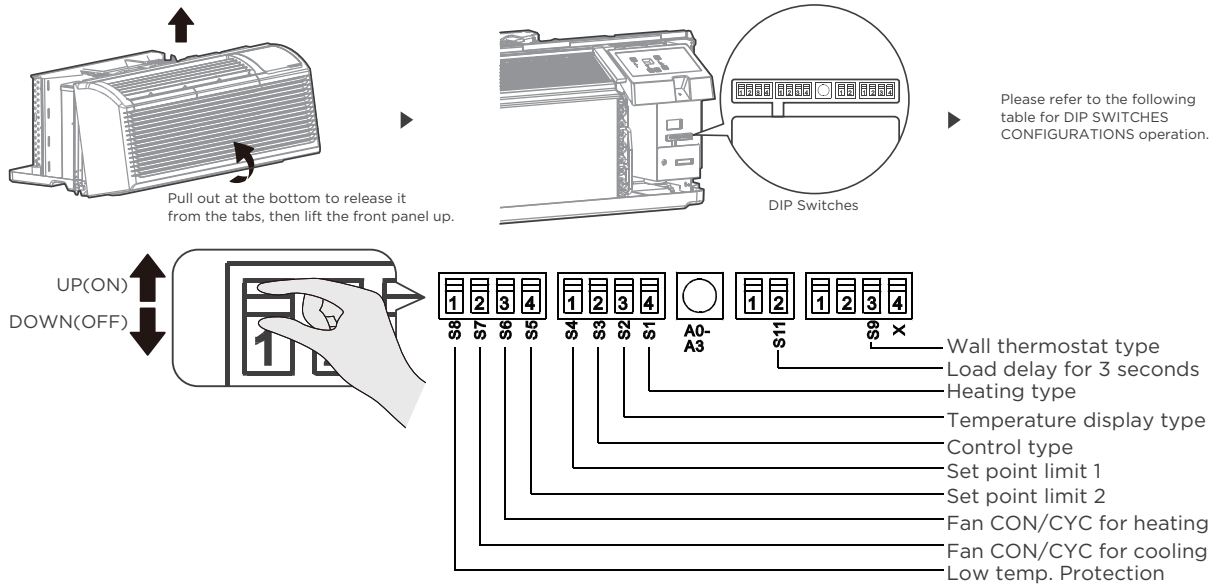

No.	UP(ON)	DOWN(OFF)	Remarks
S1	Electric Heat Only	Electric Heat and Pump Heat	For Heat Pump unit only
S3	Wall Thermostat Enable	Control Panel Enable	
S4*S5	UP*UP:60°F-86°F(16°C-30°C); UP*DOWN:65°F-78°F(18°C-26°C); DOWN*UP:63°F-80°F(17°C-27°C); DOWN*DOWN:68°F-75°F(20°C-24°C);		Two configurations (S4*S5) combine to select set point range.
S6	Fan Continuous Run for Heating	Fan Cycle for Heating	
S7	Fan Continuous Run for Cooling	Fan Cycle for Cooling	
S8	Low temp. Protection enable	Low temp. Protection disable	Optional
S9 (S3UP)	Use other types of wall Thermostat	Use other types of wall Thermostat	you can consult with the sales agency or manufacturer for details
S9 (S3DOWN)	Use Control Panel only	Use Control Panel or other types of wall Thermostat	Use control Panel or some types of wall Thermostat, the other one must be turned off
Sw11	Load delay for 3 seconds	Normal	Optional

*** Low temp. Protection(optional)**

- If unit senses a room temperature below 32°F(0°C) , the fan motor and electric strip heat will turn on and warm the room to 40°F(4.4°C) . The fan stops a short time after the temperature is satisfied.

*** Heat and Cool Fan CON/CYC Dip-switches**

- Allows the fan to operate in continuous or cycle modes while the unit is in heating and cooling mode.

CON(Continuous)

Allows fan to run continuously,circulating air even when the temperature setting hasbeen satisfied.This switch helps to maintain the room temperature closer to thethermostat setting.

CYC(Cycle)

This setting allows the fan to cycle on and of with the compressor or electric heater. The fan stops a short time after the temperature setting is satisfied.

*** Electric Heat Only (for heat pump unit only)**

- This setting is typically used for Emergency Heating.

*** Set-point Temperature Limits**

- Provides a restricted range of temperature control.

*** Wall Thermostat Enable**

- A wired wall thermostat can be connected to the unit .If it is,this dip switch must be moved to the Wall Thermostat Enable Position,before the wall thermostat will begin control.

3.7 Dip Switches Configurations By Panel Control(Optional)

- Press the up and down buttons together for 3 seconds to activate the dip switches configurations by panel control.
- See next table.

NOTE: Press the up and down buttons together for 3 seconds again or no operation within 30 seconds to exit the dip switches configurations by panel control and the unit will save the last settings.

- Display function settings with 2 digitals in LED display window, high (left) for dip switches, low (right) for functions
- Press up button to set the dip switches, press down button to set the functions.

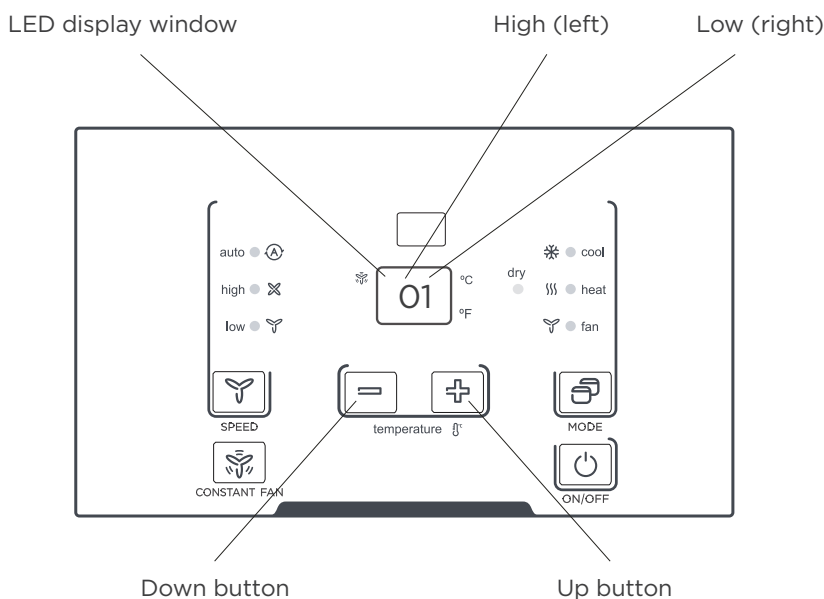

No.	High(left)	Low(right)		Remarks
/	0	1-by panel control	0-by dip switches	
S1	1	1-electric heat only	0-electric heat and pump heat	For Heat Pump unit only
S3*S9	3	3-use control panel or some types of wall thermostat; 2-use other types of wall thermostat; 1-use other types of wall thermostat; 0-control panel enable.		You can consult with the sales agency or manufacturer for details
S4*S5	4	4-62°F-86°F(17°C-30°C); 3-60°F-86°F(16°C-30°C); 2-65°F-78°F(18°C-26°C); 1-63°F-80°F(17°C-27°C); 0-68°F-75°F(20°C-24°C);		
S6	6	1-fan continuous run for heating	0-fan cycle for heating	Not available for "1-use other types of wall thermostat"
S7	7	1-fan continuous run for cooling	0-fan cycle for cooling	
S8	8	1-low temp. protection enable	0-low temp. protection disable	Optional
SW7	A	1-front desk control disable	0-front desk control enable	Optional
sw11	B	1-Load delay for 3 seconds	0-normal	Optional

NOTE:

1. The LED display window will show 00 when you first enter the setting mode, only when you set 01 you can start the next settings.
2. To activate front desk control function, you need to pull the dip switch SW7 to DOWN(OFF) , and then set the panel control to A0 .
3. After all set, press up and down buttons together for 3 seconds to exit the operation interface and cut of the power. When re-power on, the settings are activated.

3.8 WALL THERMOSTAT TERMINAL (Optional)

IMPORTANT: Only trained, qualified personnel should access electrical panel on unit and install electrical accessories. Please contact your local electrical contractor, dealer, or distributor for assistance.

1. Thermostat Wire Routing

Thermostat wire is field supplied. Recommended wire gauge is 18 to 20 gauge solid thermostat wire.

NOTE: It is recommended that extra wires are run to unit in case any are damaged during installation. Thermostat wire should always be routed around or under, NEVER through, the wall sleeve. The wire should then be routed behind the front panel to the easily accessible terminal connector.

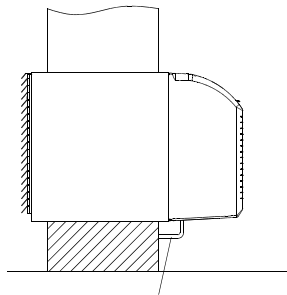

THERMOSTAT WIRE ROUTING (UNDER SLEEVE, BEHIND FRONT PANEL)

Fig. - Proper Wire Routing Beneath Unit

2. Installation instruction of some types of wall Thermostat (you can Consult with the sales agency or manufacturer for details)

- Pull the dip switch to the DOWN(OFF) position as shown below.

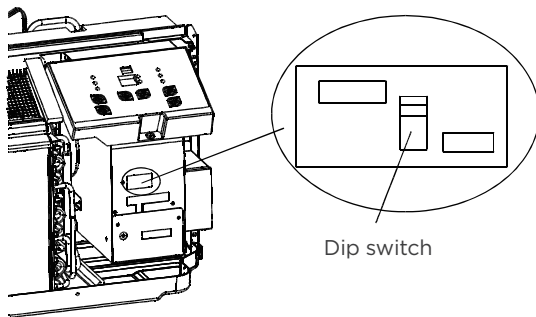

- Insert the wire connector of the wall thermostat into the relevant terminal according to different shapes as shown below.

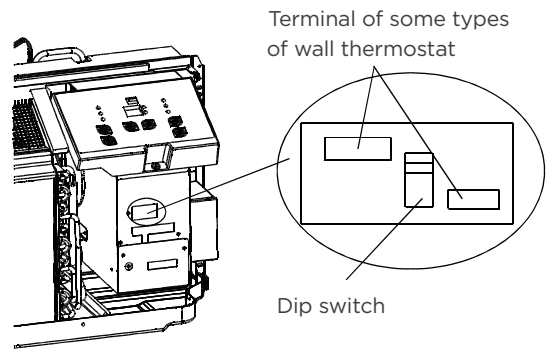

3. Installation instruction of PTAC other Wall Thermostat

- Remove the two screws as shown below and take the cover panel down.

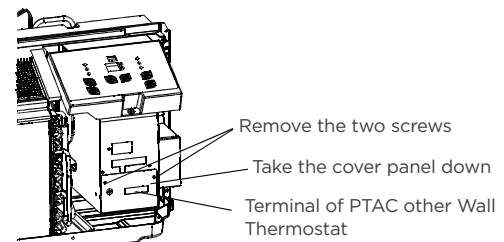

Terminal of PTAC Wall Thermostat (MODE A)

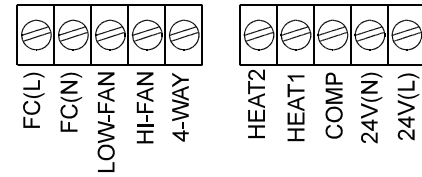

Terminal of PTAC Wall Thermostat (MODE B)

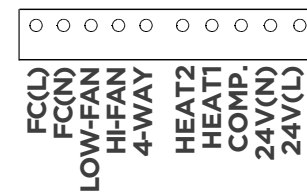

TERMINAL	DESIGNATION	MODE B Wire color
FC(L)	Front desk control terminal L	Brown
FC(N)	Front desk control terminal N	Pink
LOW-FAN	Low fan speed	Purple
HI-FAN	High fan speed	Green
4-WAY	4-way valve; Reverse cycle (Energized in Heat) For heat pump models	Blue
HEAT2	Electrical heater 2	White
HEAT1	Electrical heater 1	White
COMP	Compressor	Yellow
24V(N)	24VAC terminal N(Neutral), Common	Black
24V(L)	4VAC terminal L	Red

⚠ CAUTION

UNIT DAMAGE HAZARD

- Failure to follow this caution may result in equipment damage or improper operation.
- Improper wiring may damage unit electronics. Common busing is not permitted. Damage or erratic operation may result.

Note:

- Use terminal 4-way for heat pump connection only.
- Suggest set the compressor protection time more than 3 minutes in wall thermostat. If set less than 3 minutes, the compressor will restart delay 3 minutes still.
- Wall thermostat must be heating changeover 4-way valve.
- For thermostats that have only one fan speed output (on or auto), the fan speed is determined by how the terminal connector is wired. If Low fan is desired, wire the G output from the thermostat to (LOW-FAN) on the units terminal block.
- If High fan is desired, wire the G output from the thermostat to (HI-FAN) on the units terminal block.
- The range of set temperature of Wall thermostat must be in consonance with the range of DIP switch setting.
- Wall thermostat must be set the type properly in consonance with the unit type : heat pump or no heat pump.
- If the Wall thermostat has only one electrical heater output, connect the two terminals of HEAT 1 and HEAT 2, the unit can operate two electrical heaters (only for the unit has two electrical heaters). Otherwise operate one electrical heater.
- Please do not remove the control panel.

4. Front Desk Control

The controller can handle a switch signal from FC(L) and FC(N) input, called front desk control. Input must be 24VAC. If system doesn't receive a 24VAC signal, it will turn unit off; otherwise, the unit runs in normal control.

The DIP switch can control the FRONT DESK CONTROL feature. The DIP switch is on the DOWN position, the unit will be turn off; otherwise, the unit runs in normal control.

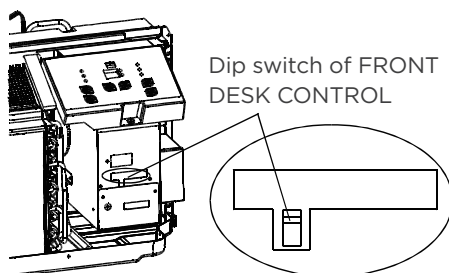

Installation Details

Contents

1. Before you get start	2
2. Before the installation.....	2
3. Installation overview.....	3

1. Before you get start

What is in the Package

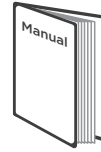
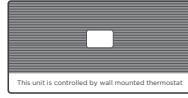
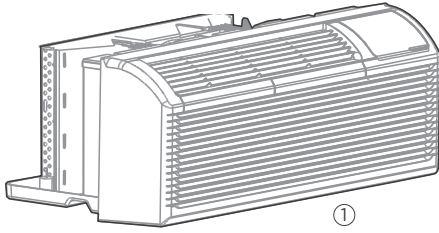

- ① Unit
- ② Control panel sticker
- ③ Owner's manual

Subbase kit (for 265V model only, optional)

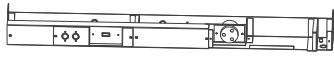

- ① Subbase
- ② Cover panel I
- ③ Cover panel II
- ④ Screws x8

Subbase kit Model: MWP-S3500/20A (used for cord connected units with 3.5kw Electric Heater)

What you need to purchase

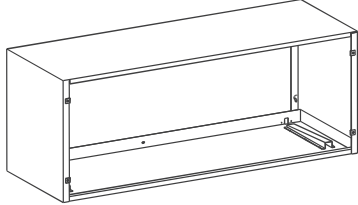

Wall sleeve

*Not Included

Prepare the following tools



Gloves



Screwdriver



Pencil



Drill



Ruler or tape measure



Level

*Not Included

2. Before the installation



The installation must be carried out in strict accordance with the instructions in this manual.



Installing your AC should take about 60 minutes.



We recommend doing this with a helper.



We're here if you need us, please contact your local distributor for assistance.

! INSTALLATION SIZE AND POSITION REQUIREMENTS

! CAUTION

Be careful! There are sharp edges that can cause serious cuts.

Installation size confirmation :

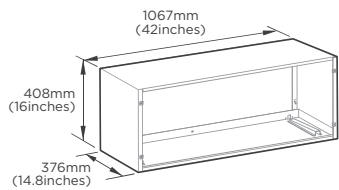

Wall sleeve size requirements (wall hole size should refer to the wall sleeve size)

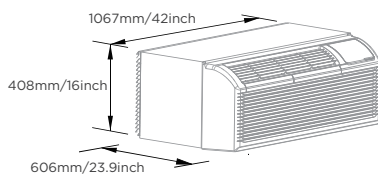

Product size

Confirmation of installation position :

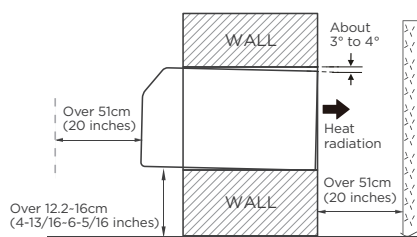

NOTE

To make the appliance work better, please do not place a barrier in the air outlet.

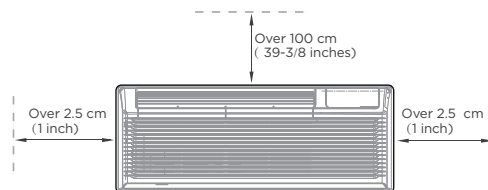

3. Installation overview

Installing unit into the wall

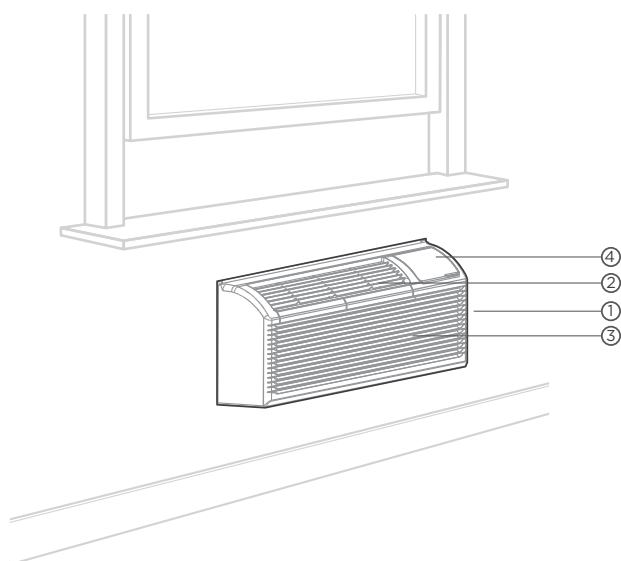

- ① Unit
- ② Outlet
- ③ Air Intake
- ④ Control panel cover

NOTE

Illustrations in this manual are for explanatory purposes. The actual shape of your unit may be slightly different. The actual shape shall prevail.

Type1: Instructions for non-265V models

Preparations for Unit Installation

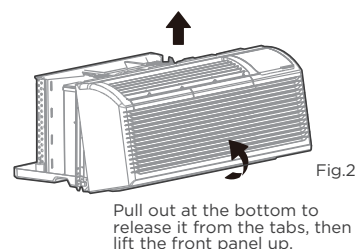
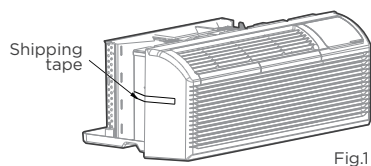
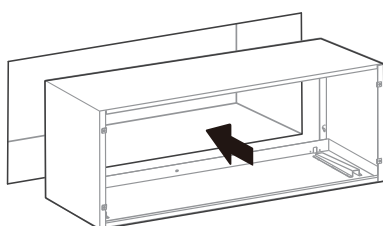

1

Attach Wall sleeve.

Refer to the installation instruction of sleeve assembly for details. To avoid vibration and noise, make sure the wall sleeve is installed securely and firmly.

2

Prepare for unit installation.

Carefully remove shipping tapes from the front panel. (See Fig.1)
Remove the front panel. (See Fig.2)

Unit Installation

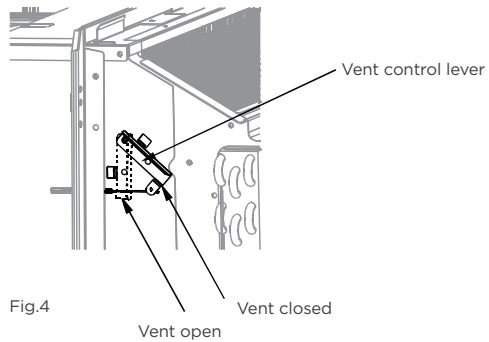
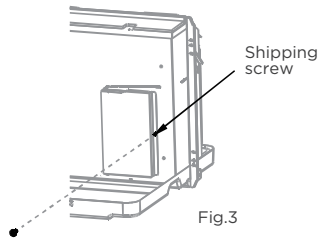

3

Install and fix the main part of the unit.

Remove the shipping screw from the vent door. (See Fig.3)

Rotate the vent control lever to either open or close the vent door. (See Fig.4)



NOTE:

When vent control lever set at CLOSE, only the air inside the room is circulated and filtered. When set at OPEN, some outdoor air will be drawn into room. This will reduce heating or cooling efficiency.



CAUTION:

- Do not put obstacles around air-inlet or inside of air-outlet of the unit, such as window curtain etc.
- Always insert the filter securely, clean filter once every two weeks as required.

Install the unit into the wall sleeve

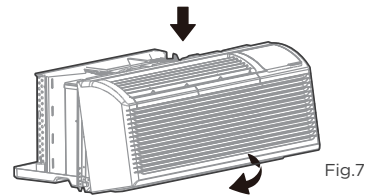
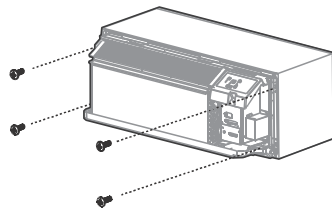
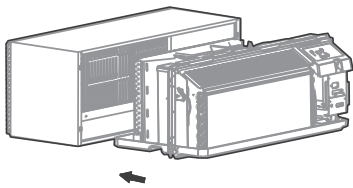

4

Install the unit into the wall sleeve

Lift unit level and slide unit into wall sleeve until firmly against front of wall sleeve and secure with 4 screws and washers (supplied in the SLEEVE ASSEMBLY) through the unit flange holes. (See Fig.5 and Fig.6)

5

Reinstall front panel.

Place tabs over top rail. Push inward at bottom until panel snaps into place. (See Fig.7)

Type 2: Instructions for 265V model (Optional)

Preparations for subbase Installation

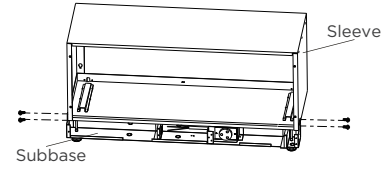
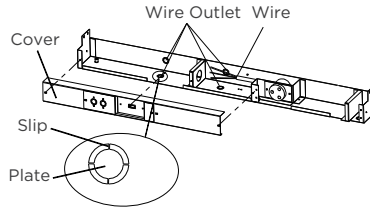
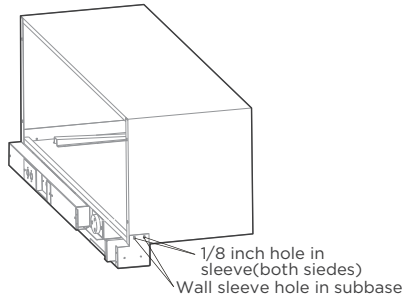

1

Drill four 1/8-inch holes.

Drill four 1/8-inch holes in the sleeve to line up with the wall sleeve holes in subbase as shown below.

2

Prepare for unit subbase's wiring.

Remove the COVER by loosening 3 screws, select one from the four wire outlets according to your need and remove the plate by clipping four slips as shown below. Then burnish the wire outlet and spray anticorrosive paint to it to avoid cutting and rusting the wires. Insert conduit into the wire outlet and connect the wires of the conduit with the SUBBASE in accordance with all electrical codes.
NOTE: Make sure the appliance is properly grounded.

3

Install the subbase to the sleeve.

Install the SUBBASE to the SLEEVE with four screws as shown above and tighten them.

Subbase kit Installation

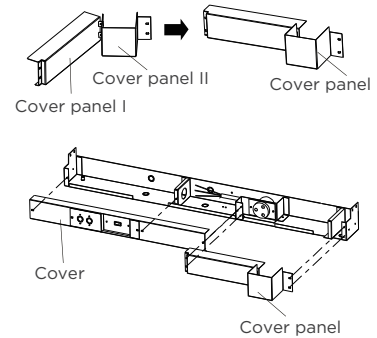
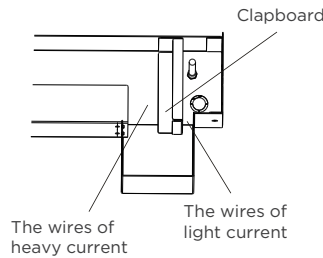
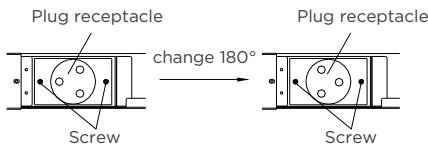
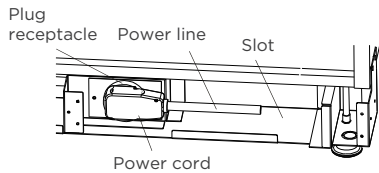

4

Install the unit to the sleeve.

Install the unit into the SLEEVE (refer to the installation instructions of the unit) and plug the power cord of the unit into the plug receptacle of the SUBBASE as shown below. The power line can be wound and placed in the slot of the SUBBASE.
NOTE: The direction of the plug receptacle can be changed 180° by loosening two screws and restall it as shown below so that it is suitable for different power cord.

5

Assemble the Subbase.

Reset the COVER PANEL II into the COVER PANEL I and rotate a certain angle as shown. And install the COVER and COVER PANEL to the SUBBASE with 7 screws securely as shown.

NOTE: The wires of heavy current shall be placed in the left of the clapboard, and the wires of light current shall be placed in the right of it as shown below. The appliance shall be installed in accordance with national wiring regulations.

Troubleshooting

Contents

1. General Troubleshooting	2
1.1 Error Display	2
2. Engineering Mode	3
3. Troubleshooting by Error Code	4
3.1 E0(EEPROM parameter error) diagnosis and solution	4
3.2 AS/ES/CS/oS/HS(Open circuit or short circuit of temperature sensor)diagnosis and solution	5
3.3 E4(Main PCB/Display board communication error) diagnosis and solution.....	6
3.4 LE(Drive-by-wire controller failure) diagnosis and solution.....	7
3.5 E3(The indoor fan speed is operating outside of the normal range) diagnosis and solution	8

1. General Troubleshooting

1.1 Error Display

The error codes are described in the following tables:

Display	Information
R5	Open or short circuit of T1 temperature sensor
E5	Open or short circuit of T2 temperature sensor
C5	Open or short circuit of T3 temperature sensor
O5	Open or short circuit of T4 temperature sensor
H5	Open or short circuit of T5 or T6 temperature sensor
L0	Temperature is lower than display range(32°F/0°C)
H1	Temperature is higher than display range(99°F/37°C)
FP	Low temperature Protection
E4	Main PCB/Display board communication error
LE	Drive-by-wire control failure
E0	EEPROM parameter error
E3	The indoor fan speed is operating outside of the normal range

2. Engineering Mode

In order to enter engineer mode, in power-on or standby mode, and in non-locked state, press the key combination “+, - & mode” for 5s:

Channel	Code	Query Content	Additional Notes
0	nA	Error code, protection code, software version, EE version and the last 6 digits of the code	When there is a fault or protection, the error code will be displayed directly. Otherwise, nA, software version, EE version, and the last 6 digits of the EE code are displayed in turn.
1	T1	T1 temperature	Display 3 digits in 2 times (with decimal point) (°C/°F)
2	T2	T2 temperature	Display 3 digits in 2 times (with decimal point) (°C/°F)
3	T3	T3 temperature	Display 3 digits in 2 times (with decimal point) (°C/°F)
4	T4	T4 temperature	Display 3 digits in 2 times (with decimal point) (°C/°F)
5		Reserved	
6		Reserved	
7		Reserved	
8		Reserved	
9		Reserved	
10	Sn	Indoor capacity test	NA
11		Reserved	
12	Pr	Outdoor fan speed	Display 3 digits in 2 times (10 times)
13		Reserved	
14	lr	Indoor fan speed	Display 3 digits in 2 times (10 times)
15		Reserved	
16		Reserved	
17	SH	After-sales bar code writing	
18	IF	WIFI signal strength	NA
19		Reserved	
20		Reserved	
21	T5	Temperature of discharge (T5)	Display 3 digits in 2 times (with decimal point) (°C/°F)
22	T6	Temperature of discharge (T6)	Display 3 digits in 2 times (with decimal point) (°C/°F)
23	FL	Filter time	Display 4 digits in 2 times(hour)

Exit conditions:

1. Engineering mode is displayed for 10 minutes in 17 channels and exits after 1 minute in other channels.
2. Switch on/off, change mode, fan speed or set temperature, exit the engineering mode.

3. Troubleshooting by Error Code

3.1 E0(EEPROM parameter error) diagnosis and solution

Description: Main chip does not receive feedback from EEPROM chip.

Recommended parts to prepare:

- Main PCB

Troubleshooting and repair:

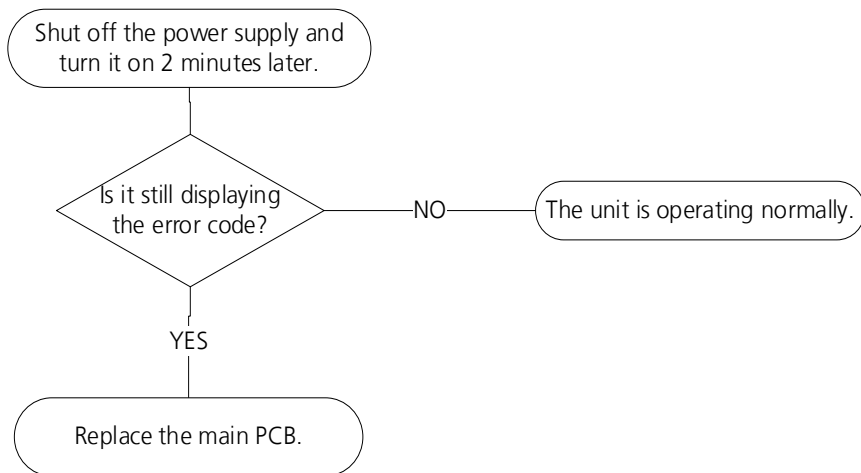

Remarks:

EEPROM: A read-only memory whose contents can be erased and reprogrammed using a pulsed voltage.

3.2 AS/ES/CS/oS/HS(Open circuit or short circuit of temperature sensor)diagnosis and solution

Description: If the sampling voltage is lower than 0.06V or higher than 4.94V, the LED displays the failure code.

Recommended parts to prepare:

- Connection wires
- Sensors
- Display PCB

Troubleshooting and repair:

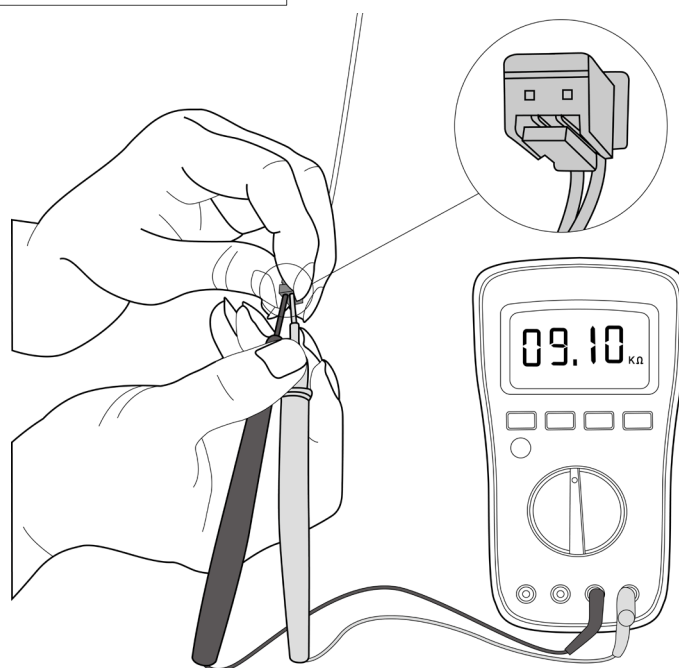
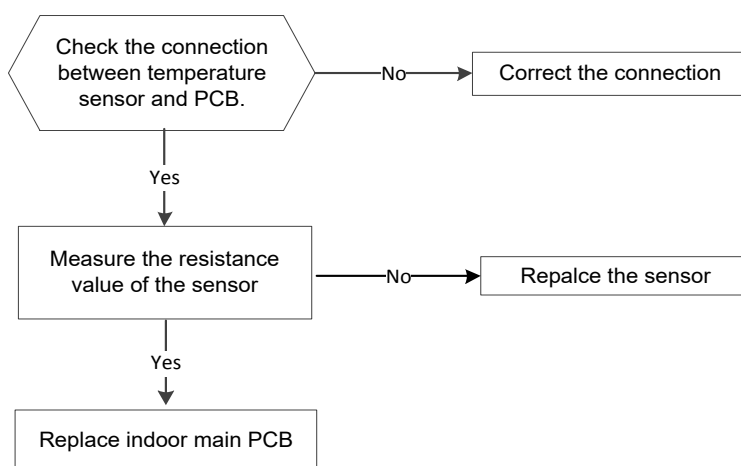

Note: This picture and the value are only for reference, actual appearance and value may vary.

3.3 E4(Main PCB/Display board communication error) diagnosis and solution

Description: The main control board does not receive feedback from display board during 120 seconds.

Recommended parts to prepare:

- Communication wire
- Main PCB
- Display board

Troubleshooting and repair:

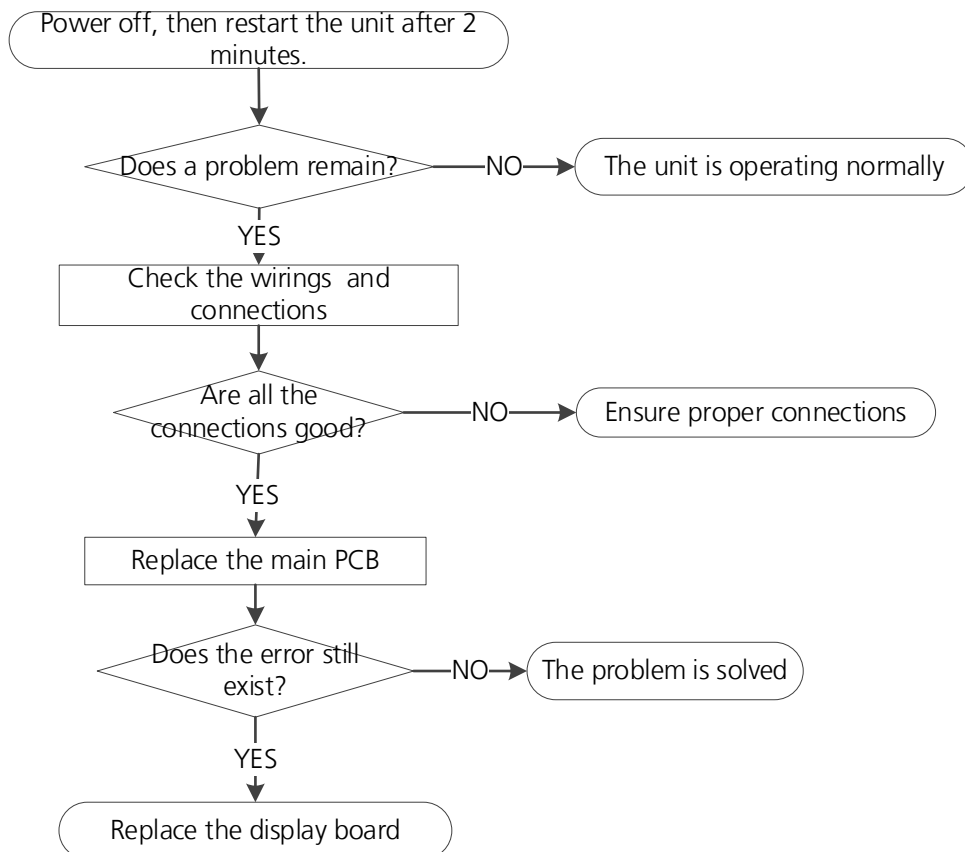

3.4 LE(Drive-by-wire controller failure) diagnosis and solution

Description:

- 1, Electric heating signal or compressor signal is on, but fan signal is off
- 2, Electric heating signal and compressor signal are on, but 4-way valve signal is off

Recommended parts to prepare:

- Connection wires
- wire controller

Troubleshooting and repair:

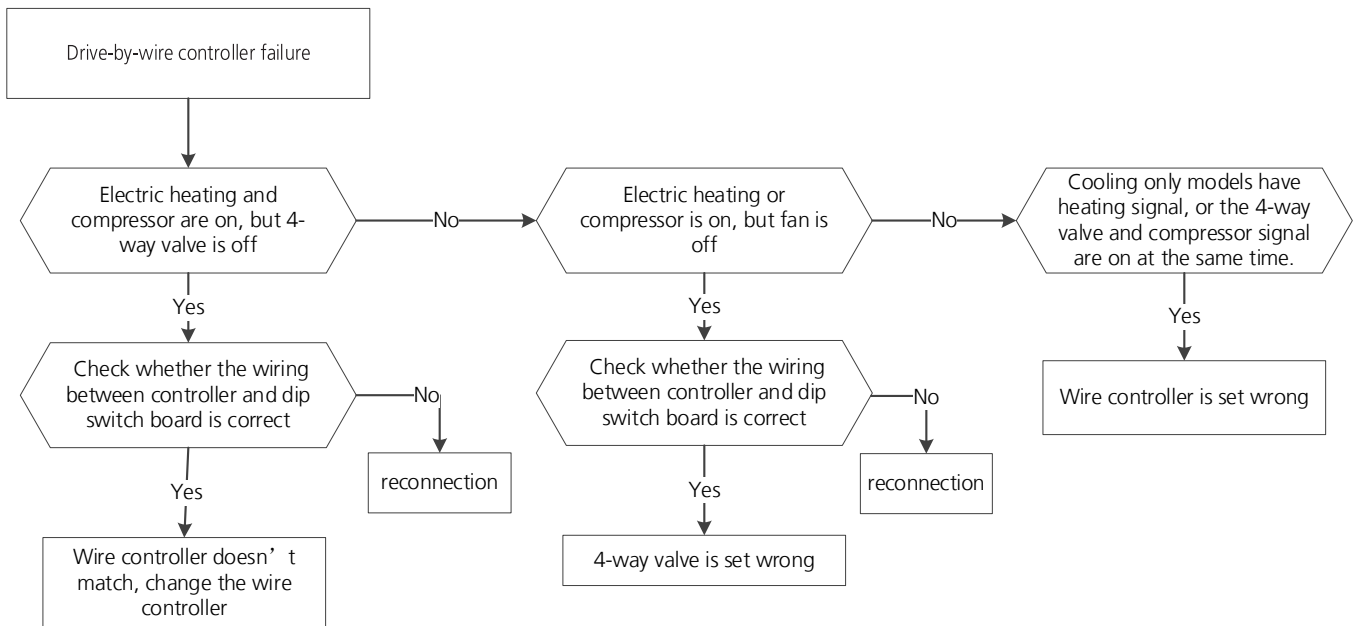

DIP SWITCH TERMINAL	DESIGNATION	24V CONTROLLER
FC(L)	Front desk control terminal L	
FC(N)	Front desk control terminal N	
LOW-FAN	Low fan speed	GL
HI-FAN	High fan speed	GH
4-WAY	4-way valve(for heat pump model)	B
HEAT2	Electrical heater 2	W
HEAT1	Electrical heater 1	(W)
COMP	Compressor	Y
24V(N)	24VAC terminal N COM	C
24V(L)	24VAC terminal L	R

3.5 E3(The indoor fan speed is operating outside of the normal range) diagnosis and solution

Description:

When indoor fan speed is too low (80RPM) or too high (2100RPM) for a period of time, the unit ceases operation and the LED displays a failure code.

Recommended parts to prepare:

- Connection wires
- Fan assembly
- Fan motor
- Main PCB

Troubleshooting and repair:

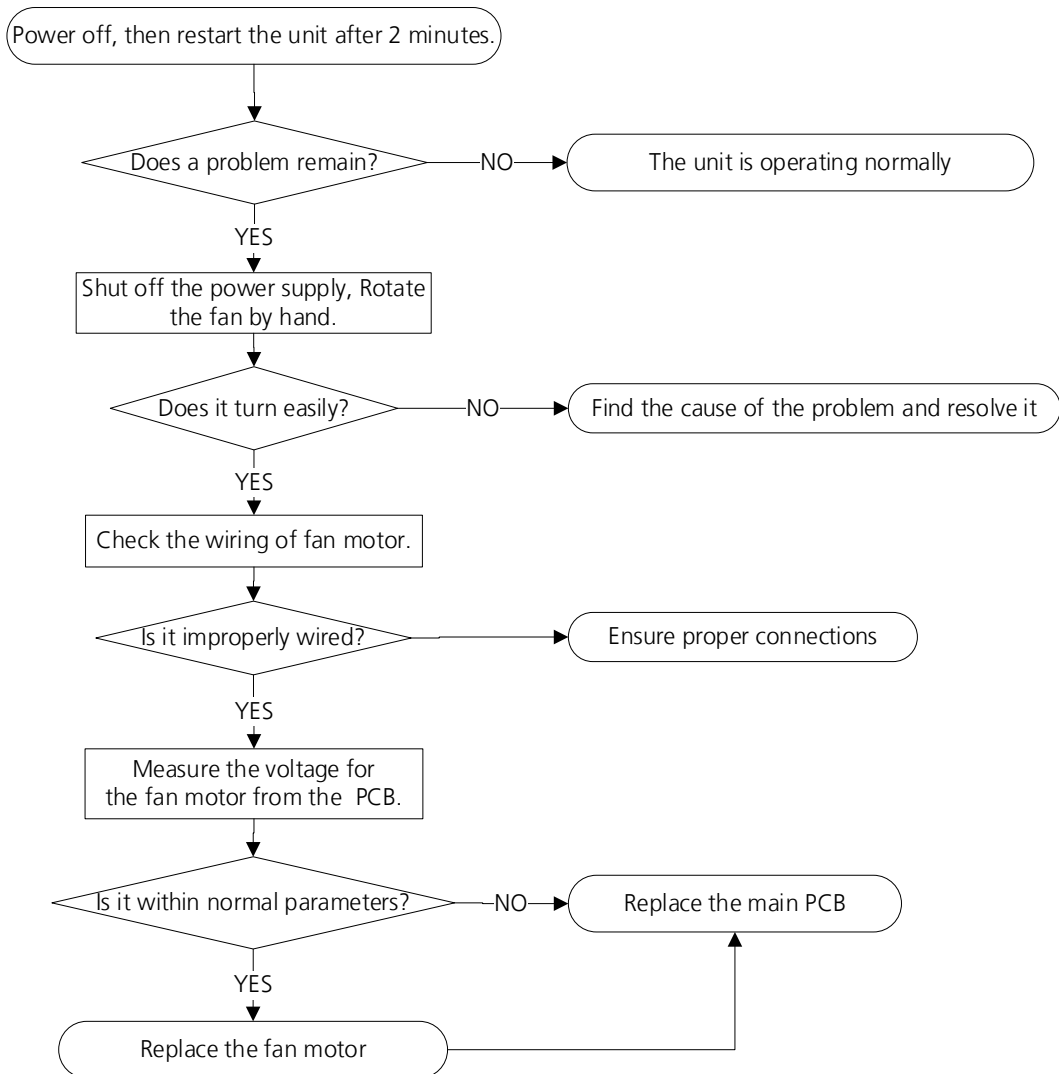

Problem	Solution
UNIT DOES NOT START	<p>Unit may have become unplugged. Check that plug is plugged securely in wall receptacle. Note: Plug has a test/reset button on it. Make sure that the plug has not tripped.</p> <p>Fuse may have blown. Replace the fuse. See Note 1.</p> <p>Unit may be off. Reset circuit breaker. See Note 1.</p> <p>Unit may be in a protection mode. Turn unit on (bottom right button on keypad).</p>
UNIT NOT COOLING/HEATING ROOM	<p>Unit air discharge section is blocked. Make sure that curtains, blinds or furniture are not restricting or blocking unit airflow.</p> <p>Temperature setting is not high or low enough. NOTE:Setpoint limits may not allow the unit to heat or cool the room to the temperature desired. Check section on dipswitch settings. Reset to a lower or higher temperature setting.</p> <p>Unit air filters are dirty. Remove and clean filters.</p> <p>Room is excessively hot or cold when unit is started. Allow sufficient amount of time for unit to heat or cool the room. Start heating or cooling early before outdoor temperature, cooking heat or gatherings of people make room uncomfortable.</p> <p>Vent door left open. Close vent door.</p> <p>Unit may be in a protection mode. Check dipswitch and wall thermostat settings for desired comfort.</p> <p>Compressor is in time delay. Wait approximately 3 minutes for compressor to start.</p>
DISPLAY HAS STRANGE NUMBERS/ CHARACTERS ON IT	<p>The unit may be in a protection mode.</p> <p>The unit may be set for °C(instead of °F).</p>
UNIT MAKING NOISES	Clicking, gurgling and whooshing noises are normal during operation of unit.
WATER DRIPPING OUTSIDE	If a drain kit has not been installed, condensation runoff during very hot and humid weather is normal. See Note 2.If a drain kit has been installed and is connected to a drain system, check gaskets and fittings around drain for leaks and plugs.
WATER DRIPPING INSIDE	Wall sleeve must be installed level for proper drainage of condensation .Check that installation is level and make any necessary adjustments.
ICE OR FROST FORMS ON INDOOR COIL	<p>Low outdoor temperature. When outdoor temperature is approximately 55°F or below, frost may form on the indoor coil when unit is in Cooling mode. Switch unit to FAN operation until ice or frost melts.</p> <p>The filters are dirty. Remove and clean filters.</p>
COMPRESSOR PROTECTION	<p>Power may have cycled, so compressor is in a restart protection.</p> <p>Random Compressor restart - Whenever the unit is plugged in, or power has been restarted, a random compressor restart will occur. After a power outage, the compressor will restart after approximately 3 minutes.</p>
ELECTRIC HEATING FAILURE	Clean the evaporator once every three months by professional people.

NOTES:

1. If circuit breaker is tripped or fuse is blown more than once,contact a qualified electrician.
2. If unit is installed where condensation drainage could drip in an undesirable location,an accessory drain kit should be installed and connected to drain system.

Disassembly Guide-PTAC

Contents

1. Unit Disassembly	2
1.1 Panel Frame Assembly.....	2
1.2 Display Board Subassembly	3
1.3 Electrical Parts (Antistatic gloves must be worn.)	4
1.4 Indoor Thermistor	9
1.5 Indoor Fan Motor and Fan	10
1.6 Outdoor Fan Motor and Fan	17
1.7 Condenser Assembly.....	19
1.8 Outdoor Thermistor	20

1. Unit Disassembly

1.1 Panel Frame Assembly

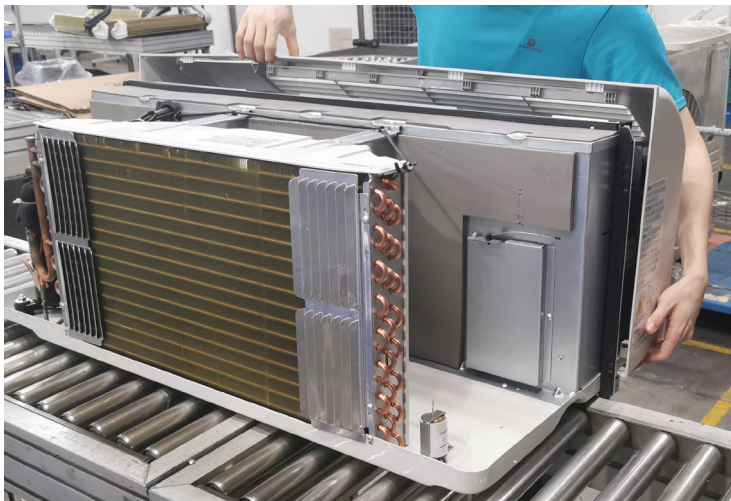
Procedure	Illustration
<p>1) Release the seven clasps and then remove the panel frame assembly. (see CJ_PTAC_001)</p>	 <p data-bbox="963 1014 1136 1048">CJ_PTAC_001</p>

Note: This section is for reference only. Actual unit appearance may vary.

1.2 Display Board Subassembly

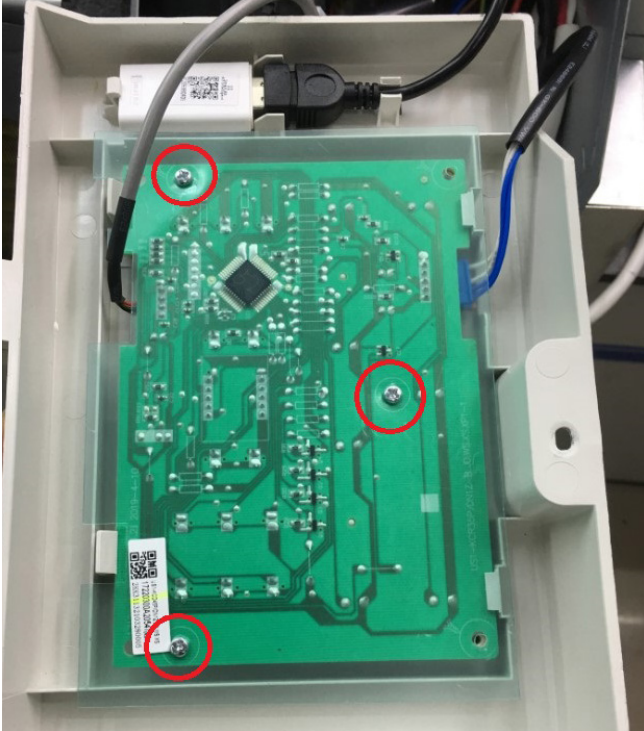
Procedure	Illustration
<p>1) Remove the 3 screws fixing display box subassembly. (see CJ_PTAC_002)</p>	 <p>CJ_PTAC_002</p>
<p>2) Turn over display box subassembly. 3) Remove 3 screws and then remove the display board subassembly. (see CJ_PTAC_003)</p>	 <p>CJ_PTAC_003</p>

Note: This section is for reference only. Actual unit appearance may vary.

1.3 Electrical Parts (Antistatic gloves must be worn.)

Procedure	Illustration
<p>1) Remove fixing screws(3 screws) of cable board of electronic control box, and then remove it. (see CJ_PTAC_004-1 & CJ_PTAC_004-2)</p>	 <p data-bbox="954 1310 1149 1344">CJ_PTAC_004-1</p>  <p data-bbox="954 1863 1149 1897">CJ_PTAC_004-2</p>

Note: This section is for reference only. Actual unit appearance may vary.

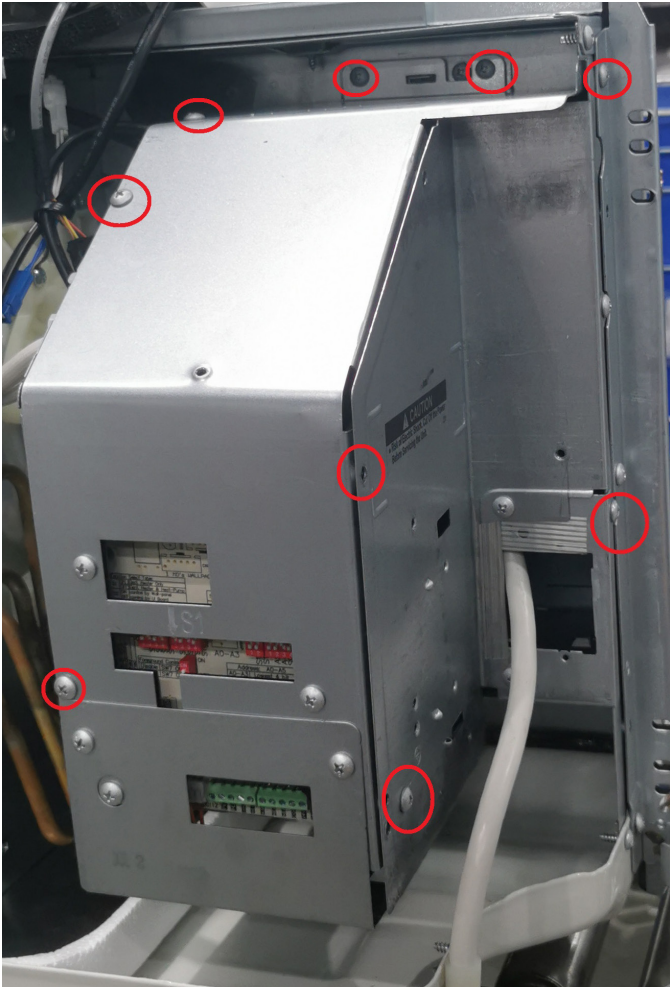
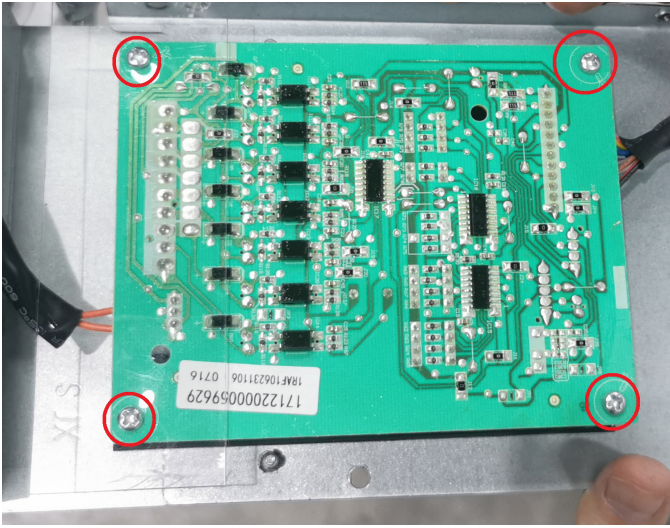
Procedure	Illustration
<p>2) Remove 9 screws, and then remove cover board of electronic control box. (see CJ_PTAC_005)</p> <p>3) Remove 4 screws, and then remove the dial switch subassembly (see CJ_PTAC_006)</p>	 <p style="text-align: center;">CJ_PTAC_005</p>  <p style="text-align: center;">CJ_PTAC_006</p>

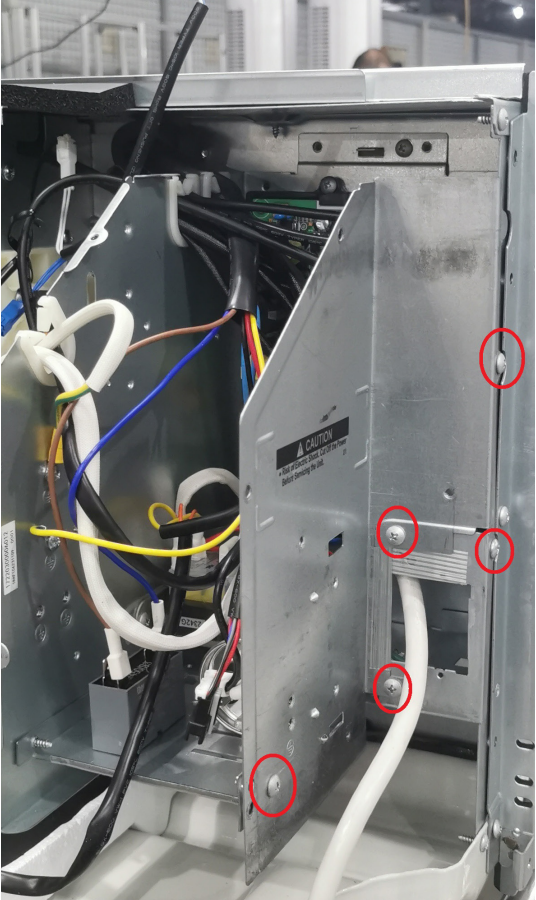
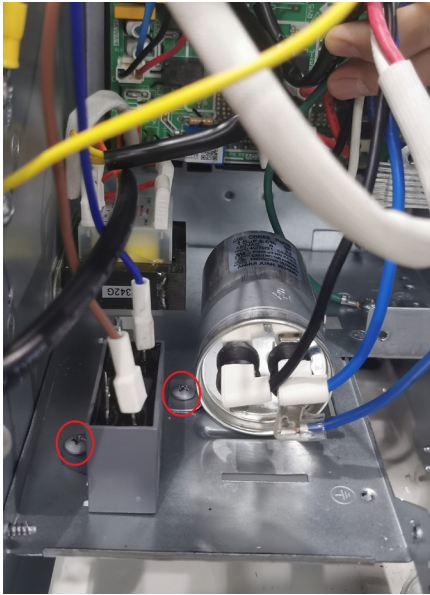

Note: This section is for reference only. Actual unit appearance may vary.

Procedure	Illustration
<p>4) Remove 5 screws, and then remove side board of electronic control box. (see CJ_PTAC_007)</p>	 <p style="text-align: center;">CJ_PTAC_007</p>
<p>5) Remove 1 screw, and then remove the fan capacitor. (see CJ_PTAC_008)</p> <p>6) Remove 1 screw, and then remove the compressor capacitor. (see CJ_PTAC_008)</p>	 <p style="text-align: center;">CJ_PTAC_008</p>

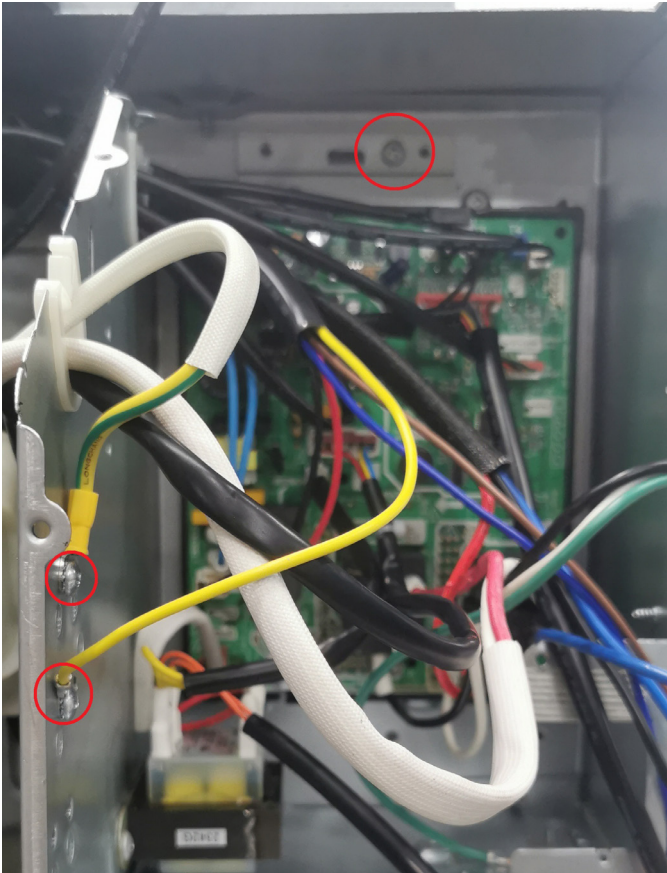
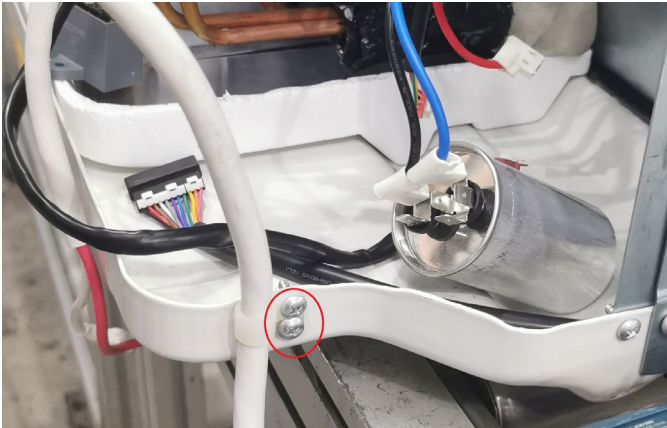
Note: This section is for reference only. Actual unit appearance may vary.

Procedure	Illustration
<p>7) Remove 1 fixing screw and 2 grounding screws. (see CJ_PTAC_009)</p> <p>8) Disconnect the connector wire.(see CJ_PTAC_009)</p> <p>9) Remove 2 screws fixing the power cord. (see CJ_PTAC_010)</p> <p>10)Then remove the electronic control box assembly.</p>	 <p style="text-align: center;">CJ_PTAC_009</p>  <p style="text-align: center;">CJ_PTAC_010</p>

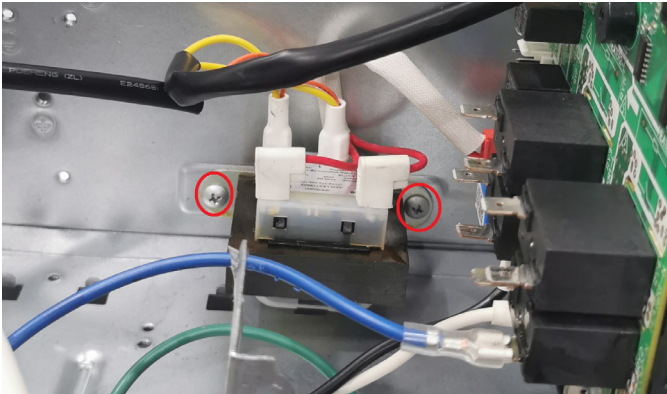
Note: This section is for reference only. Actual unit appearance may vary.

Procedure	Illustration
<p>11) Remove 2 screws, and then remove the transformer (see CJ_PTAC_011)</p>	 <p style="text-align: center;">CJ_PTAC_011</p>
<p>12) Remove 2 screws, and then remove the main control board subassembly. (see CJ_PTAC_012)</p>	 <p style="text-align: center;">CJ_PTAC_012</p>

Note: This section is for reference only. Actual unit appearance may vary.

1.4 Indoor Thermistor

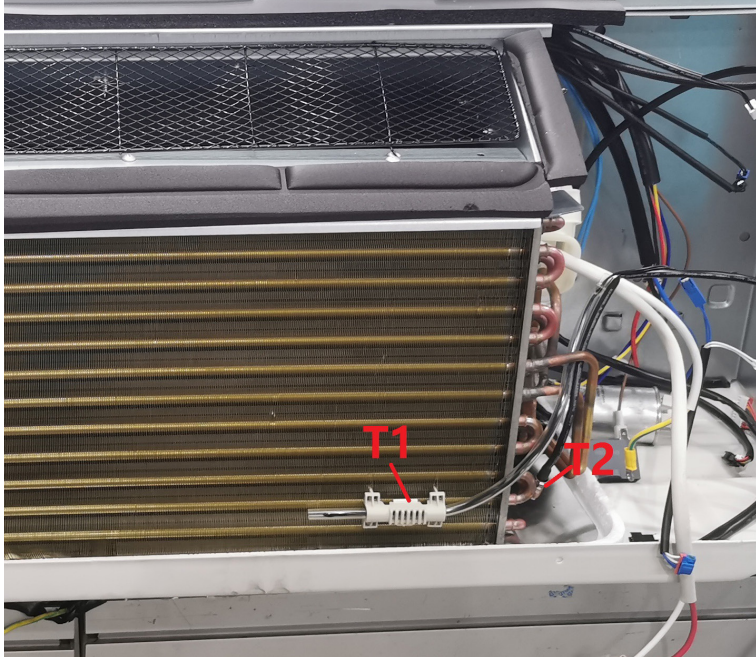
Procedure	Illustration
<p>1) Pull out the sensor. (see CJ_PTAC_013)</p> <p>T1: Ambient temperature sensor</p> <p>T2: Indoor coil temperature sensor</p>	 <p>The photograph shows the interior of an HVAC unit. A metal mesh grille is at the top. Below it is a coil of copper tubing. A white terminal block is mounted on the unit, with two wires connected to it. Red arrows point to the wires, labeled 'T1' and 'T2'. 'T1' points to the wire connected to the ambient temperature sensor, and 'T2' points to the wire connected to the indoor coil temperature sensor. The unit is white and has various wires and components visible.</p> <p data-bbox="963 1095 1137 1126">CJ_PTAC_013</p>

Note: This section is for reference only. Actual unit appearance may vary.

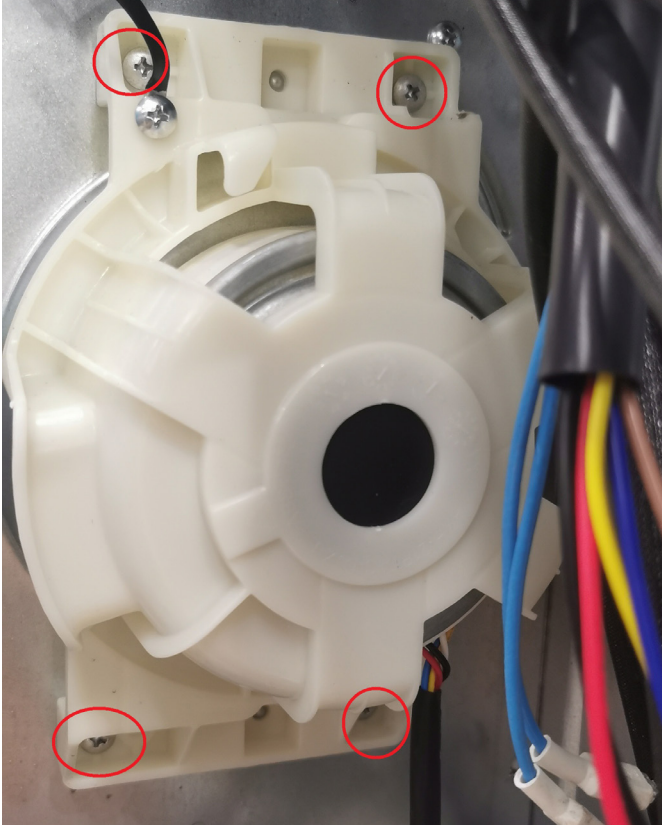
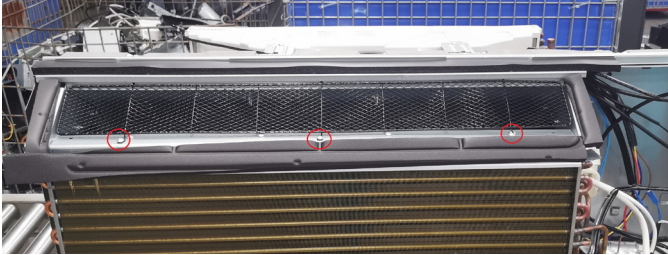

1.5 Indoor Fan Motor and Fan

Procedure	Illustration
<p>1) Remove 4 screws, and then remove the motor cover assembly. (see CJ_PTAC_014)</p>	 <p data-bbox="965 1211 1139 1240">CJ_PTAC_014</p>
<p>2) Remove 3 screws, and then remove the protective net. (see CJ_PTAC_015)</p>	 <p data-bbox="965 1543 1139 1572">CJ_PTAC_015</p>

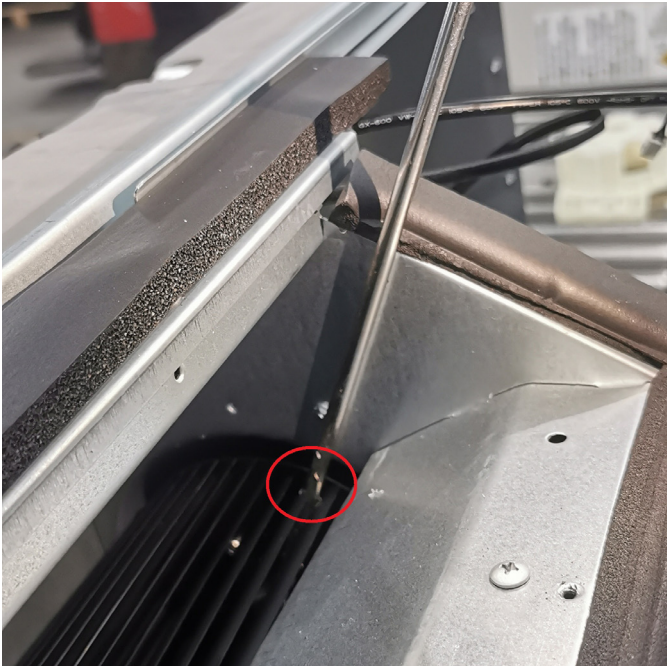
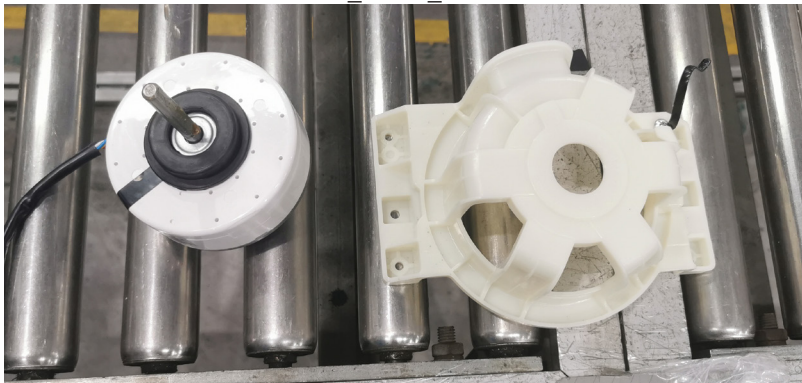
Note: This section is for reference only. Actual unit appearance may vary.

Procedure	Illustration
<p>3) Remove the 1 fixing screw located in cross flow fan. (see CJ_PTAC_016)</p>	 <p>CJ_PTAC_016</p>
<p>4) Remove the fan motor. (see CJ_PTAC_017)</p>	 <p>CJ_PTAC_017</p>

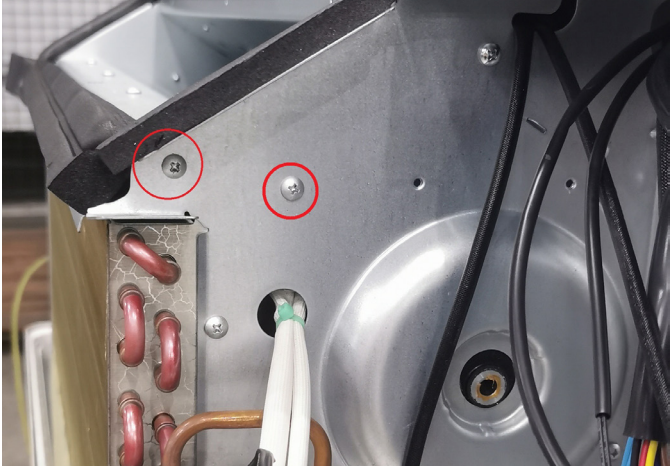
Note: This section is for reference only. Actual unit appearance may vary.

Procedure	Illustration
<p>5) Remove the 8 screws and then remove the volute shell. (see CJ_PTAC_018-1& CJ_PTAC_018-2)</p>	 <p style="text-align: center;">CJ_PTAC_018-1</p>  <p style="text-align: center;">CJ_PTAC_018-2</p>

Note: This section is for reference only. Actual unit appearance may vary.

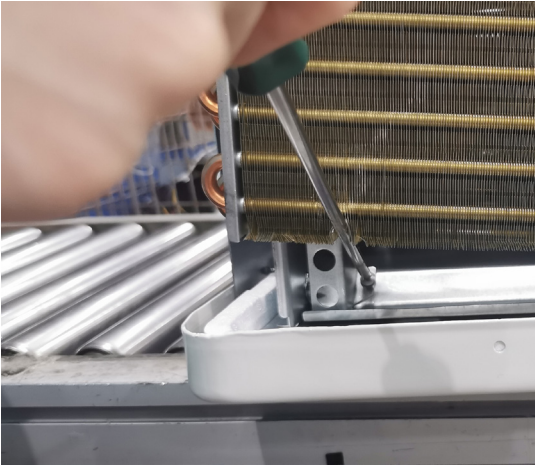
Procedure	Illustration
<p>6) Remove 4 screws fixing the evaporator assembly. (see CJ_PTAC_019)</p>	 <p style="text-align: center;"> right side left side </p> <p style="text-align: center;">CJ_PTAC_019</p>
<p>7) Lift left of the evaporator slightly, then remove 1 screw fixing the electric heater assembly. (see CJ_PTAC_020)</p>	 <p style="text-align: center;">CJ_PTAC_020</p>

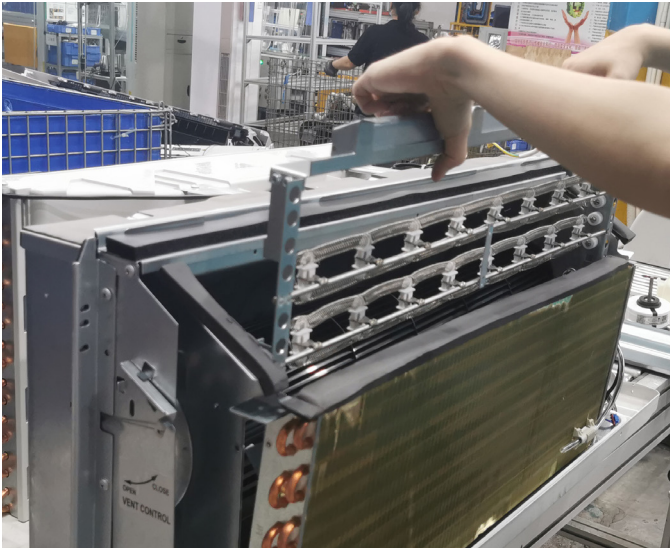
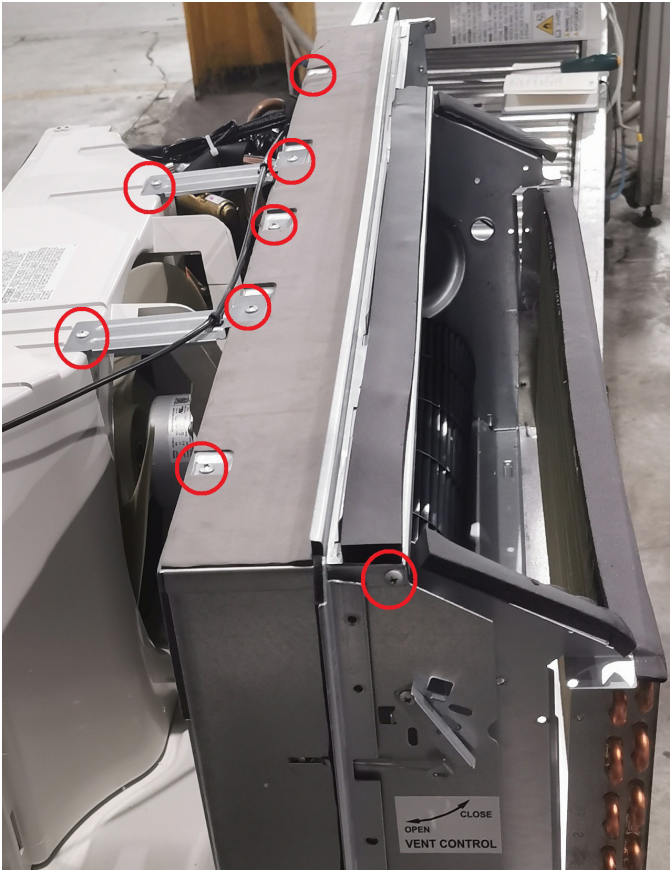

Note: This section is for reference only. Actual unit appearance may vary.

Procedure	Illustration
<p>8) Lift the electric heater assembly. (see CJ_PTAC_021)</p>	 <p style="text-align: center;">CJ_PTAC_021</p>
<p>9) Remove the 13 screws and then remove the air duct plate subassembly. (see CJ_PTAC_022-1 & CJ_PTAC_022-2& CJ_PTAC_022-3 & CJ_PTAC_022-4)</p>	 <p style="text-align: center;">CJ_PTAC_022-1</p>

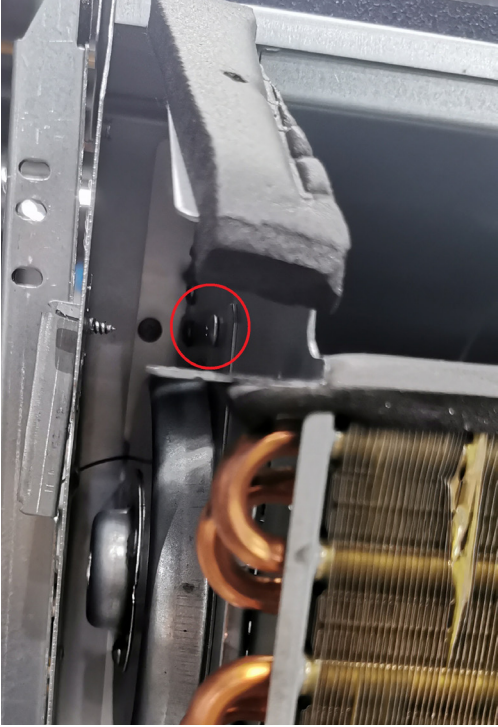
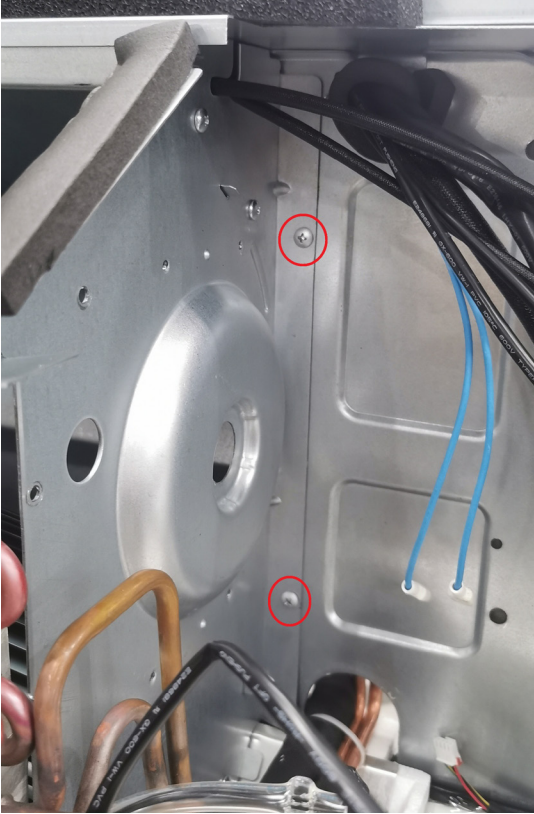
Note: This section is for reference only. Actual unit appearance may vary.



Procedure	Illustration
<p>10) Remove the 13 screws and then remove the air duct plate subassembly. (see CJ_PTAC_022-1 & CJ_PTAC_022-2 & CJ_PTAC_022-3 & CJ_PTAC_022-4)</p>	 <p style="text-align: center;">CJ_PTAC_022-2</p>
<p>11) Remove the 13 screws and then remove the air duct plate subassembly. (see CJ_PTAC_022-1 & CJ_PTAC_022-2 & CJ_PTAC_022-3 & CJ_PTAC_022-4)</p>	 <p style="text-align: center;">CJ_PTAC_022-23</p>

Note: This section is for reference only. Actual unit appearance may vary.

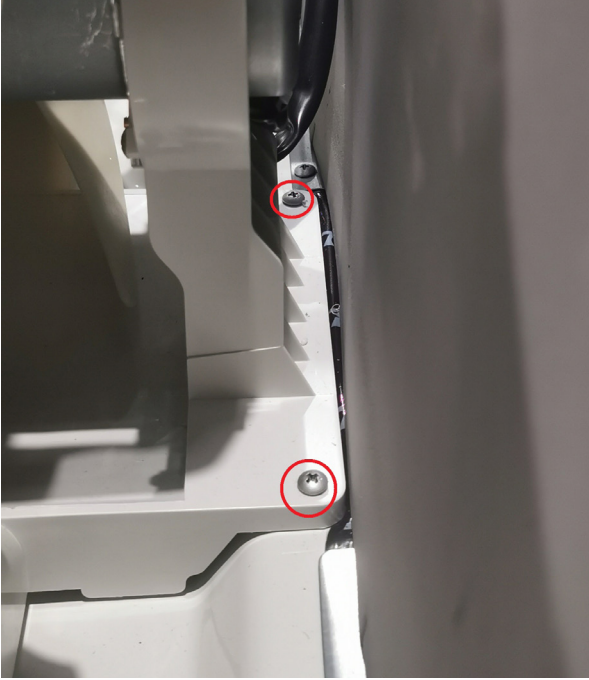

Procedure	Illustration
<p>12) Remove the 13 screws and then remove the air duct plate subassembly. (see CJ_PTAC_022-1 & CJ_PTAC_022-2& CJ_PTAC_022-3 & CJ_PTAC_022-4)</p>	 <p data-bbox="954 1435 1150 1464">CJ_PTAC_022-4</p>
<p>13) Take out the cross flow fan. (see CJ_PTAC_023)</p>	 <p data-bbox="965 1861 1136 1890">CJ_PTAC_023</p>

Note: This section is for reference only. Actual unit appearance may vary.

1.6 Outdoor Fan Motor and Fan

Procedure	Illustration
<p>1) Remove 2 screws. (see CJ_PTAC_024)</p>	 <p>CJ_PTAC_024</p>
<p>2) Lift the back panel(with the axial flow fan and motor)(see CJ_PTAC_025)</p>	 <p>CJ_PTAC_025</p>

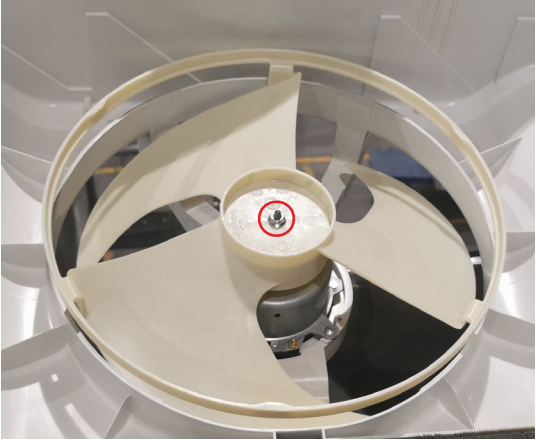
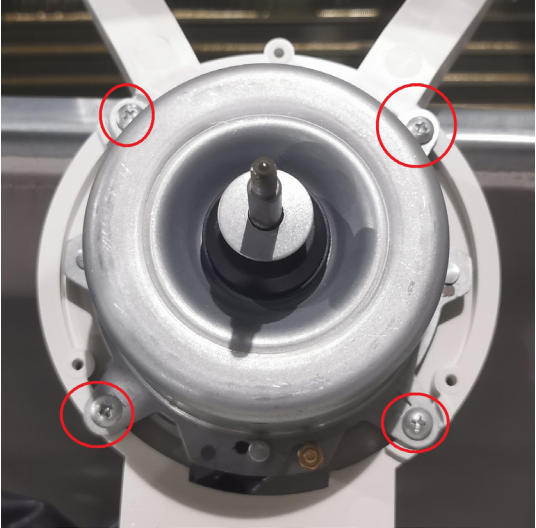
Note: This section is for reference only. Actual unit appearance may vary.

Procedure	Illustration
<p>3) Remove the nut securing the fan with a spanner. (see CJ_PTAC_026)</p> <p>4) Remove the axial flow fan.</p>	 <p>CJ_PTAC_026</p>
<p>5) Remove the fixing screws of the fan motor (4 screws). (see CJ_PTAC_027)</p> <p>6) Remove the outdoor fan motor.</p>	 <p>CJ_PTAC_027</p>
<p>7) Remove the 2 screws and then remove the drain valve.(see CJ_PTAC_028)</p>	 <p>CJ_PTAC_028</p>

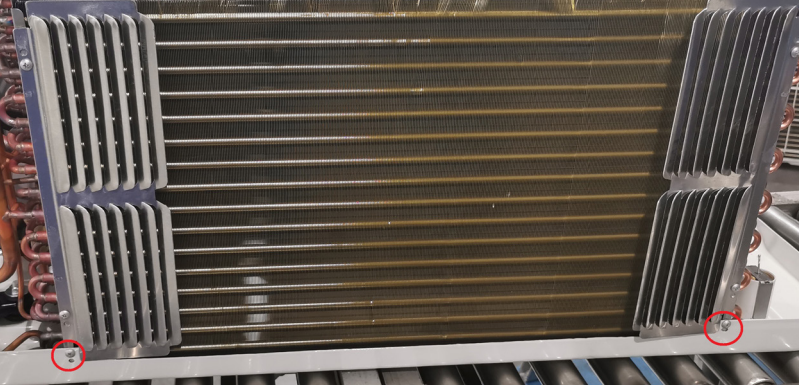

Note: This section is for reference only. Actual unit appearance may vary.

1.7 Condenser Assembly

Procedure	Illustration
<p>1) Remove 2 screws to remove the condenser assembly. (see CJ_PTAC_029)</p>	 <p>CJ_PTAC_029</p>

Note: This section is for reference only. Actual unit appearance may vary.

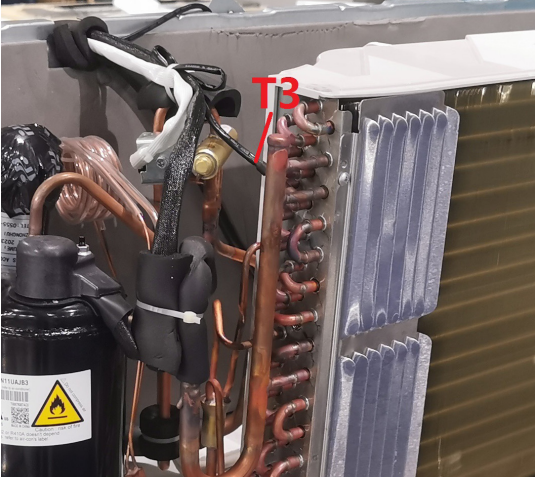
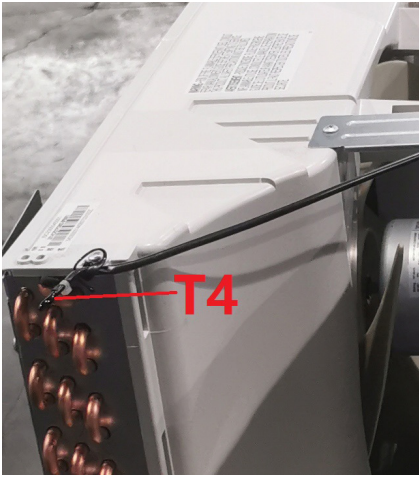
1.8 Outdoor Thermistor

Procedure	Illustration
<p>1) Pull out the sensor. (see CJ_PTAC_030, CJ_PTAC_031& CJ_PTAC_032)</p> <p>T3: Outdoor coil temperature sensor T4: Outdoor ambient temperature sensor T5: Discharge temperature sensor 1 T6: Discharge temperature sensor 2</p>	 <p>CJ_PTAC_030</p>  <p>CJ_PTAC_031</p>  <p>T5&T6 CJ_PTAC_032</p>

Note: This section is for reference only. Actual unit appearance may vary.

Appendix

Contents

i)	Temperature Sensor Resistance Value Table for T1, T2, T3, and T4 (°C – K)	2
ii)	Temperature Sensor Resistance Value Table for T5&T6(°C --K)	3
iii)	Pressure On Service Port	4

i) Temperature Sensor Resistance Value Table for T1,T2,T3 and T4 (°C – K)

°C	°F	K Ohm	°C	°F	K Ohm	°C	°F	K Ohm	°C	°F	K Ohm
-20	-4	115.266	20	68	12.6431	60	140	2.35774	100	212	0.62973
-19	-2	108.146	21	70	12.0561	61	142	2.27249	101	214	0.61148
-18	0	101.517	22	72	11.5	62	144	2.19073	102	216	0.59386
-17	1	96.3423	23	73	10.9731	63	145	2.11241	103	217	0.57683
-16	3	89.5865	24	75	10.4736	64	147	2.03732	104	219	0.56038
-15	5	84.219	25	77	10	65	149	1.96532	105	221	0.54448
-14	7	79.311	26	79	9.55074	66	151	1.89627	106	223	0.52912
-13	9	74.536	27	81	9.12445	67	153	1.83003	107	225	0.51426
-12	10	70.1698	28	82	8.71983	68	154	1.76647	108	226	0.49989
-11	12	66.0898	29	84	8.33566	69	156	1.70547	109	228	0.486
-10	14	62.2756	30	86	7.97078	70	158	1.64691	110	230	0.47256
-9	16	58.7079	31	88	7.62411	71	160	1.59068	111	232	0.45957
-8	18	56.3694	32	90	7.29464	72	162	1.53668	112	234	0.44699
-7	19	52.2438	33	91	6.98142	73	163	1.48481	113	235	0.43482
-6	21	49.3161	34	93	6.68355	74	165	1.43498	114	237	0.42304
-5	23	46.5725	35	95	6.40021	75	167	1.38703	115	239	0.41164
-4	25	44	36	97	6.13059	76	169	1.34105	116	241	0.4006
-3	27	41.5878	37	99	5.87359	77	171	1.29078	117	243	0.38991
-2	28	39.8239	38	100	5.62961	78	172	1.25423	118	244	0.37956
-1	30	37.1988	39	102	5.39689	79	174	1.2133	119	246	0.36954
0	32	35.2024	40	104	5.17519	80	176	1.17393	120	248	0.35982
1	34	33.3269	41	106	4.96392	81	178	1.13604	121	250	0.35042
2	36	31.5635	42	108	4.76253	82	180	1.09958	122	252	0.3413
3	37	29.9058	43	109	4.5705	83	181	1.06448	123	253	0.33246
4	39	28.3459	44	111	4.38736	84	183	1.03069	124	255	0.3239
5	41	26.8778	45	113	4.21263	85	185	0.99815	125	257	0.31559
6	43	25.4954	46	115	4.04589	86	187	0.96681	126	259	0.30754
7	45	24.1932	47	117	3.88673	87	189	0.93662	127	261	0.29974
8	46	22.5662	48	118	3.73476	88	190	0.90753	128	262	0.29216
9	48	21.8094	49	120	3.58962	89	192	0.8795	129	264	0.28482
10	50	20.7184	50	122	3.45097	90	194	0.85248	130	266	0.2777
11	52	19.6891	51	124	3.31847	91	196	0.82643	131	268	0.27078
12	54	18.7177	52	126	3.19183	92	198	0.80132	132	270	0.26408
13	55	17.8005	53	127	3.07075	93	199	0.77709	133	271	0.25757
14	57	16.9341	54	129	2.95896	94	201	0.75373	134	273	0.25125
15	59	16.1156	55	131	2.84421	95	203	0.73119	135	275	0.24512
16	61	15.3418	56	133	2.73823	96	205	0.70944	136	277	0.23916
17	63	14.6181	57	135	2.63682	97	207	0.68844	137	279	0.23338
18	64	13.918	58	136	2.53973	98	208	0.66818	138	280	0.22776
19	66	13.2631	59	138	2.44677	99	210	0.64862	139	282	0.22231

ii) Temperature Sensor Resistance Value Table for T5&T6(for some units) (°C --K)

°C	°F	K Ohm	°C	°F	K Ohm	°C	°F	K Ohm	°C	°F	K Ohm
-20	-4	542.7	20	68	68.66	60	140	13.59	100	212	3.702
-19	-2	511.9	21	70	65.62	61	142	13.11	101	214	3.595
-18	0	483	22	72	62.73	62	144	12.65	102	216	3.492
-17	1	455.9	23	73	59.98	63	145	12.21	103	217	3.392
-16	3	430.5	24	75	57.37	64	147	11.79	104	219	3.296
-15	5	406.7	25	77	54.89	65	149	11.38	105	221	3.203
-14	7	384.3	26	79	52.53	66	151	10.99	106	223	3.113
-13	9	363.3	27	81	50.28	67	153	10.61	107	225	3.025
-12	10	343.6	28	82	48.14	68	154	10.25	108	226	2.941
-11	12	325.1	29	84	46.11	69	156	9.902	109	228	2.86
-10	14	307.7	30	86	44.17	70	158	9.569	110	230	2.781
-9	16	291.3	31	88	42.33	71	160	9.248	111	232	2.704
-8	18	275.9	32	90	40.57	72	162	8.94	112	234	2.63
-7	19	261.4	33	91	38.89	73	163	8.643	113	235	2.559
-6	21	247.8	34	93	37.3	74	165	8.358	114	237	2.489
-5	23	234.9	35	95	35.78	75	167	8.084	115	239	2.422
-4	25	222.8	36	97	34.32	76	169	7.82	116	241	2.357
-3	27	211.4	37	99	32.94	77	171	7.566	117	243	2.294
-2	28	200.7	38	100	31.62	78	172	7.321	118	244	2.233
-1	30	190.5	39	102	30.36	79	174	7.086	119	246	2.174
0	32	180.9	40	104	29.15	80	176	6.859	120	248	2.117
1	34	171.9	41	106	28	81	178	6.641	121	250	2.061
2	36	163.3	42	108	26.9	82	180	6.43	122	252	2.007
3	37	155.2	43	109	25.86	83	181	6.228	123	253	1.955
4	39	147.6	44	111	24.85	84	183	6.033	124	255	1.905
5	41	140.4	45	113	23.89	85	185	5.844	125	257	1.856
6	43	133.5	46	115	22.89	86	187	5.663	126	259	1.808
7	45	127.1	47	117	22.1	87	189	5.488	127	261	1.762
8	46	121	48	118	21.26	88	190	5.32	128	262	1.717
9	48	115.2	49	120	20.46	89	192	5.157	129	264	1.674
10	50	109.8	50	122	19.69	90	194	5	130	266	1.632
11	52	104.6	51	124	18.96	91	196	4.849			
12	54	99.69	52	126	18.26	92	198	4.703			
13	55	95.05	53	127	17.58	93	199	4.562			
14	57	90.66	54	129	16.94	94	201	4.426			
15	59	86.49	55	131	16.32	95	203	4.294			
16	61	82.54	56	133	15.73	96	205	4.167			
17	63	78.79	57	135	15.16	97	207	4.045			
18	64	75.24	58	136	14.62	98	208	3.927			
19	66	71.86	59	138	14.09	99	210	3.812			

iii) Pressure On Service Port
System Pressure Table-R32

Pressure			Temperature		Pressure			Temperature	
Kpa	bar	PSI	°C	°F	Kpa	bar	PSI	°C	°F
100	1	14.5	-51.909	-61.436	1850	18.5	268.25	28.425	83.165
150	1.5	21.75	-43.635	-46.543	1900	19	275.5	29.447	85.005
200	2	29	-37.323	-35.181	1950	19.5	282.75	30.448	86.806
250	2.5	36.25	-32.15	-25.87	2000	20	290	31.431	88.576
300	3	43.5	-27.731	-17.916	2050	20.5	297.25	32.395	90.311
350	3.5	50.75	-23.85	-10.93	2100	21	304.5	33.341	92.014
400	4	58	-20.378	-4.680	2150	21.5	311.75	34.271	93.688
450	4.5	65.25	-17.225	0.995	2200	22	319	35.184	95.331
500	5	72.5	-14.331	6.204	2250	22.5	326.25	36.082	96.948
550	5.5	79.75	-11.65	11.03	2300	23	333.5	36.965	98.537
600	6	87	-9.150	15.529	2350	23.5	340.75	37.834	100.101
650	6.5	94.25	-6.805	19.752	2400	24	348	38.688	101.638
700	7	101.5	-4.593	23.734	2450	24.5	355.25	39.529	103.152
750	7.5	108.75	-2.498	27.505	2500	25	362.5	40.358	104.644
800	8	116	-0.506	31.089	2550	25.5	369.75	41.173	106.111
850	8.5	123.25	1.393	34.507	2600	26	377	41.977	107.559
900	9	130.5	3.209	37.777	2650	26.5	384.25	42.769	108.984
950	9.5	137.75	4.951	40.911	2700	27	391.5	43.55	110.39
1000	10	145	6.624	43.923	2750	27.5	398.75	44.32	111.776
1050	10.5	152.25	8.235	46.823	2800	28	406	45.079	113.142
1100	11	159.5	9.790	49.621	2850	28.5	413.25	45.828	114.490
1150	11.5	166.75	11.291	52.324	2900	29	420.5	46.567	115.821
1200	12	174	12.745	54.941	2950	29.5	427.75	47.296	117.133
1250	12.5	181.25	14.153	57.475	3000	30	435	48.015	118.427
1300	13	188.5	15.52	59.936	3050	30.5	442.25	48.726	119.707
1350	13.5	195.75	16.847	62.325	3100	31	449.5	49.428	120.970
1400	14	203	18.138	64.648	3150	31.5	456.75	50.121	122.218
1450	14.5	210.25	19.395	66.911	3200	32	464	50.806	123.451
1500	15	217.5	20.619	69.114	3250	32.5	471.25	51.482	124.668
1550	15.5	224.75	21.813	71.263	3300	33	478.5	52.15	125.87
1600	16	232	22.978	73.360	3350	33.5	485.75	52.811	127.060
1650	16.5	239.25	24.116	75.409	3400	34	493	53.464	128.235
1700	17	246.5	25.229	77.412	3450	34.5	500.25	54.11	129.398
1750	17.5	253.75	26.317	79.371	3500	35	507.5	54.748	130.546
1800	18	261	27.382	81.288					

KLIMAIRE™ ≈

Mark of Superior Quality

7999NW 81 Place - Medley, FL 33166

Tel: (305) 593 - 8358
www.klimaite.com
customerservice@klimaite.com

The Klimaite logo is a registered Trademark of Klimaite
Products Inc. Copyright 2024 Klimaite Products Inc.

The design and specifications are subject to change without prior notice for product improvement. Consult
with the sales agency or manufacturer for details.