

KIWU/KOIU

SERIES

SPLIT-TYPE ROOM AIR CONDITIONER

Installation Manual

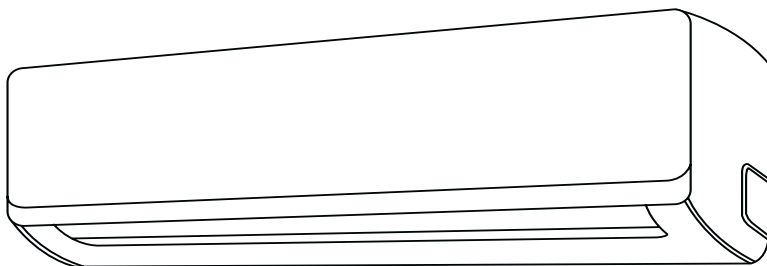

KLIMAIRE®

Mark of Superior Quality

IMPORTANT NOTE:

Read this manual carefully before installing or operating your new air conditioning unit. Make sure to save this manual for future reference.

For more information please visit www.klimaite.com

TABLE OF CONTENTS

SAFETY PRECAUTIONS	3
ACCESSORIES	5
PIPE LENGTH AND ADDITIONAL REFRIGERANT	6
UNIT PARTS AND INSTALLATION COMPONENTS	7
SELECTING THE INSTALLATION PLACE	8
INDOOR UNIT INSTALLATION	10
OUTDOOR UNIT INSTALLATION	14
AIR EVACUATION	20
REFRIGERANT	21
ELECTRICAL AND GAS LEAK CHECKS	22
TEST OPERATION	23

* The design and specifications are subject to change without prior notice for product improvement. Consult with the sales agency or manufacturer for details.

* The shape and position of buttons and indicators may vary according to the model, but their function are the same.

Safety Precautions

Read Safety Precautions Before Installation

Incorrect installation due to ignoring instructions can cause serious damage or injury.

The seriousness of potential damage or injuries is classified as either a **WARNING** or **CAUTION**.



This symbol indicates that ignoring instructions may cause moderate injury to person, or damage to your unit or other property.

CAUTION

1. Install drainage piping according to the instructions in this manual. Improper drainage may cause water damage to your home and property.
2. Never insert your finger or a stick, etc into the air inlet or outlet. Doing so could cause damage to the unit or injury.
3. The product must be properly grounded at the time of installation, or electrical shock may occur.



This symbol indicates that you must never perform the action indicated.

DO NOT











1. **Do not** modify the length of the power supply cord or use an extension cord to power the unit.
2. **Do not** share the electrical outlet with other appliances. Improper or insufficient power supply can cause fire or electrical shock.
3. **Do not** let any substances or gases other than the specified refrigerant when connecting the refrigerant piping to enter the unit. The presence of other gases or substances will lower the unit capacity and can cause abnormally high pressure in the refrigeration cycle. this can cause explosion and injury.
4. **Do not** allow children to play with the air conditioner. Children must be supervised around the unit at all times.
5. **Do not** obstruct the air inlet or outlet of the indoor or outdoor unit. Obstruction of these openings causes a reduction of the operative efficiency of the air conditioner with possible consequent failures or damages
6. **Do not** install the unit in a location that may be exposed to combustible gas leaks. If combustible gas accumulates around the unit, it may cause fire.
7. **Do not** operate your air conditioner in a wet room such as a bathroom or laundry room. Too much exposure to water can cause electrical components to short circuit.

Safety Precautions



WARNING

This symbol indicates that ignoring instructions may cause death or serious injury.











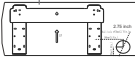





-  1. Installation must be performed according to the installation instructions. Improper installation can cause water leakage, electrical shock, or fire.
-  2. Contact an authorized service technician for repair or maintenance of this unit.
-  3. Only use the included accessories, parts, and specified parts for installation. Using non-Standard parts can cause water leakage, electrical shock, fire, and can cause the unit to fail.
-  4. Install the unit in a firm location that can support the unit's weight. If the chosen location cannot support the unit's weight, or the installation is not done properly, the unit may drop and cause serious injury and damage.
-  5. Always operate the unit with air filter mounted. The use of air conditioner without a filter could cause an excessive accumulation of dust and lint on the coil & inner parts of the device with possible subsequent failures
-  6. For all electrical work, follow all local and national wiring standards, regulations, and the Installation Manual. You must use an independent circuit and single outlet to supply power. Do not connect other appliances to the same outlet. Insufficient electrical capacity or defects in electrical work can cause electrical shock or fire.
-  7. For all electrical work, use the specified cables. Connect cables tightly, and clamp them securely to prevent external forces from damaging the terminal. Improper electrical connections can overheat and cause fire, and may also cause shock.
-  8. All wiring must be properly arranged to ensure that the control board cover can close properly. If the control board cover is not closed properly, it can lead to corrosion and cause the connection points on the terminal to heat up, catch fire, or cause electrical shock.
-  9. In certain functional environments, such as kitchens, server rooms, etc., the use of specially designed air-conditioning units is highly recommended.
-  10. Electrical installation, service, maintenance and repair of this unit must be performed by a certified technician. Disconnect the power support to the air conditioning system during the procedure.

Note about Fluorinated Gasses

1. This air-conditioning unit contains fluorinated gasses. For specific information on the type of gas and the amount, please refer to the relevant label on the unit itself.
3. Product uninstallation and recycling must be performed by a certified technician.
4. If the system has a leak-detection system installed, it must be checked for leaks at least every 12 months.
5. When the unit is checked for leaks, proper record-keeping of all checks is strongly recommended.

Accessories

The air conditioning system comes with the following accessories. Use all of the installation parts and accessories to install the air conditioner. Improper installation may result in water leakage, electrical shock and fire, or cause the equipment to fail.

Name	Shape	Quantity
Mounting Paper Board Template		1
Mounting plate		1
Clip anchor		6 pcs for 12K, 8 pcs for 24/36K
Mounting plate fixing screw		6 pcs for 12K, 8 pcs for 24/36K
Remote controller		1
Remote Control Holder		1
Healthy Air freshening filter		2 (used to be install on the front of air filter)
Remote Control Holder Fixing Screw		2
Inerconnecting cable		1
Outdoor Unit Drain joint		1
Condensate Drain Hose Extension		2
Vibration Pads		4
Plastic Wall Sleeve		1
Plastic Wall Cap		2
Wall Sealer Mastic		2
Decorative insulation tape		2

The accessories described herein may be different for each model and the list is for reference only.

INSTALLATION MANUAL

Pipe Length and Additional Refrigerant

Inverter Models Capacity (Btu/h)	9K-12K		18K-36K	
Length of pipe with standard charge	5m/16ft	5m/16ft	5m/16ft	5m/16ft
Length of pipe with standard charge (Like: North American, etc.)	7.5m/24ft	7.5m/24ft	7.5m/24ft	7.5m/24ft
Maximum distance between indoor and outdoor unit	15m/49ft	15m/49ft	25m/82ft	25m/82ft
Additional refrigerant charge	20g/m	15g/m	30g/m	25g/m
Max. diff. in level between indoor and outdoor unit	10m/32ft	10m/32ft	10m/32ft	10m/32ft
Type of refrigerant	R410A	R32	R410A	R32

Torque Parameters

PIPE Size	Newton meter[N x m]	Pound-force foot (lbf-ft)	Kilogram-force meter (kgf-m)
1/4 " (ϕ 6.35)	18 - 20	24.4 - 27.1	2.4 - 2.7
3/8 " (ϕ 9.52)	30 - 35	40.6 - 47.4	4.1 - 4.8
1/2 " (ϕ 12)	45 - 50	61.0 - 67.7	6.2 - 6.9
5/8 " (ϕ 15.88)	60 - 65	81.3 - 88.1	8.2 - 8.9

 **Note: This table is only for reference, the installation shall meet the requirements of local laws and regulations.**

UNIT PARTS AND INSTALLATION COMPONENTS

NOTE: The installation must be performed in accordance with the requirement of local and national standards. The installation may be slightly different in different areas.

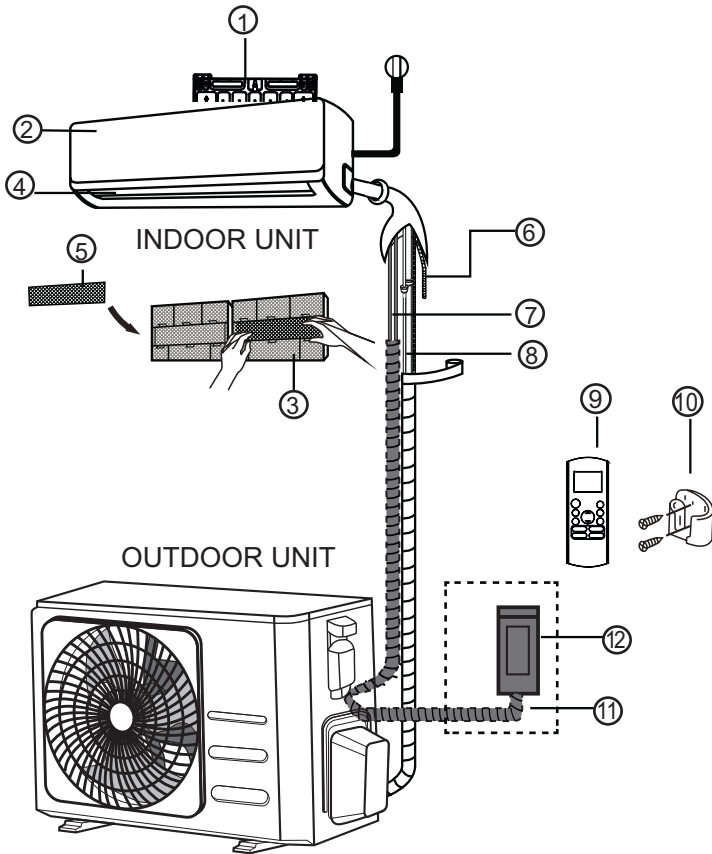

- | | | |
|-----------------------|---|---|
| ① Wall Mounting Plate | ⑤ Functional Filter (On Back of Main Filter - Some Units) | ⑨ Remote Controller |
| ② Front Panel | ⑥ Drainage Pipe | ⑩ Remote controller Holder (Some Units) |
| ③ Main Filter | ⑦ Signal Cable | ⑪ Outdoor Unit Power Cable (Not included) |
| ④ Louver | ⑧ Refrigerant Piping | ⑫ Disconnect Switch (Not included) |

NOTE ON ILLUSTRATIONS

Illustrations in this manual are for explanatory purposes. The actual shape of your indoor unit may be slightly different. The actual shape shall prevail

INSTALLATION MANUAL---Selecting the Installation Place

PRIOR TO INSTALLATION

Before installing the indoor unit, refer to the label on the product box to make sure that the voltage and the model number of the indoor unit matches the voltage and the model number of the outdoor unit.

GENERAL

The air conditioner must be installed by professional or qualified Technicians. The equipment must be installed in accordance with applicable national and local regulations and Codes. Ensure that the power supply voltage corresponds to that stamped on the rating plate. Do not obstruct the air inlet or outlet of the indoor or the outdoor unit. The obstruction of these openings causes a reduction in the operative efficiency of the conditioner with possible consequent failures or damages.

STEP 1:

Before installing the indoor unit, you must choose an appropriate location. The following are standards that will help you choose an appropriate location for the unit.

INDOOR UNIT PLACE SELECTION

- Install the indoor unit level on a strong wall that is not subject to vibrations.
- The inlet and outlet ports should not be obstructed: the air should be able to blow all over the room.
- Do not install the unit near a source of heat, steam, or flammable gas.
- Use stranded cable to interconnect indoor to outdoor unit
- Do not install the unit where it will be exposed to direct sunlight.
- Install the unit where connection between indoor and outdoor unit is as easy as possible.
- Install the unit where it is easy to drain the condensed water, preferably inside of an exterior wall.
- Check the machine operation regularly and leave the necessary space (as shown in the picture).
- Install the indoor unit where the filter can be easily accessible.
- Leave a 6" space on the top of the unit.

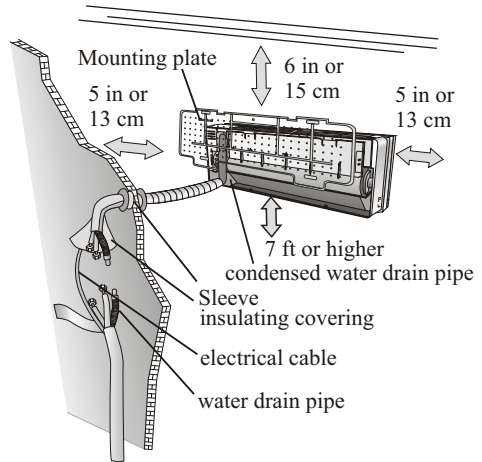

OUTDOOR UNIT PLACE SELECTION

- Do not install the outdoor unit near sources of heat, steam or flammable gas.
- Make sure that the base of the outdoor unit is firmly fixed.
- Do not install the unit in too windy or dusty places.
- Do not install the unit where people often pass. Select a place where the air discharge and operating sound level will not disturb neighbours.
- Avoid installing the unit where it will be exposed to direct sunlight (other wise use a protection, if necessary, that should not interfere with the air flow).
- Leave space as shown in the picture for the air to circulate freely.
- Install the outdoor unit in a safe and solid place.
- If the outdoor unit is subject to vibration, place rubber gaskets onto the feet of the unit.

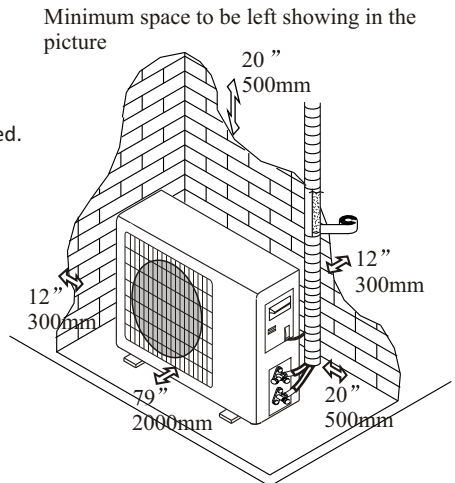

INSTALLATION MANUAL---Selecting the Installation Place

Installation Diagram

Outdoor unit

Pipe length is
50' (15m)Max

Indoor unit

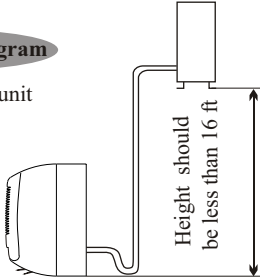

Indoor unit

Pipe length is
50' (15m)Max

Height should
be less than 16 ft

Outdoor unit

Note
Quick connect
piping kit 25 ft long

Only persons and/or companies qualified and experienced in the installation, service and repair of refrigerant products should be permitted to do so. The purchaser must ensure that the person and/or company who is to install, service or repair this air conditioner has qualifications and experience in air conditioning.

STEP 2:

Using template

Check the top of indoor unit carton box, there is a quick-installation paper board, it is a guideline to find the screw and hole drilling position quickly.

Before starting installation, decide on the position of the indoor and outdoor units, taking into account the minimum space required around the units.

- ⚠ Install the indoor unit in the room to be air conditioned avoiding in corridors or communal areas.
- ⚠ Install the indoor unit at a height of at least 7 ft from the ground.

- 2.1) Place the paper board on the wall where the unit will be installed.
- 2.2) Use a level to align the paper board.
- 2.3) Mark the screw holes and center of drilling hole on the wall with a screw or screwdriver

To install, proceed as follows:

Please adjust the layout better leaving necessary spaces

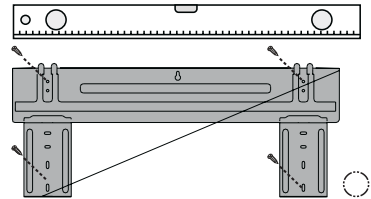
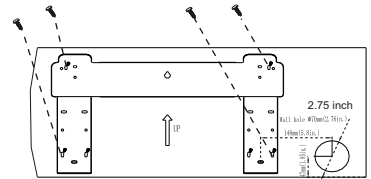

STEP 3:

Installation of the mounting plate

- 3.1 By using a level, put the mounting plate in a perfect square position vertically and horizontally.
- 3.2 Drill 1 1/4 inch deep holes in the wall to fix the plate, following the screw remark;
- 3.3 Insert the plastic anchors into the hole;
- 3.4 Fix the mounting plate by the provided screws;
- 3.5. Check that the mounting plate is correctly fixed;

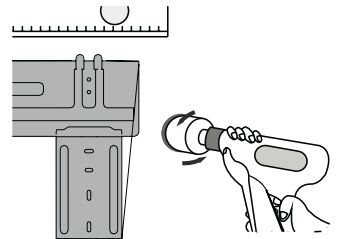

Note : The shape of the mounting plate may be different from the one above, but installation method is similar .

INSTALLATION MANUAL - Indoor Unit installation

STEP 4:

Drilling a hole in the wall for the piping

4.1 Drill the hole in the wall for the copper pipe crossing, following the quick-installation paper board marked suggested diameter is 2-3/4 in.

4.2 Set a flexible flange through the hole in the wall to keep the latter intact and clean.

⚠ The hole must slope downwards towards the exterior.

Note : Keep the drain pipe down towards the direction of the wall hole, otherwise leakage may occur.

4.3 Insert the round plastic wall sleeve into the hole

4.4 If the sleeve sticks out cut the plastic sleeve with utility knife to be flush with wall.

4.5 Insert the sleeve cap on the exterior part for the wall

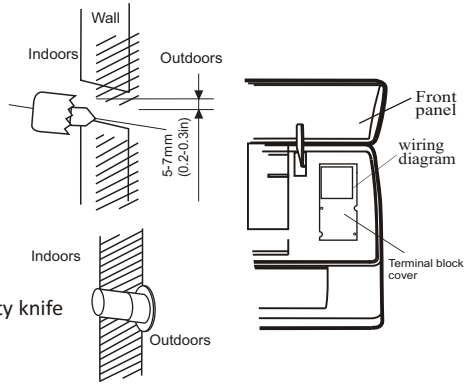

STEP 5:

Refrigerant piping setting position

5.1 The copper pipe should be set through the wall to outside when installing the indoor unit, for quick connecting to be connected to the outdoor unit.

5.2 Run the piping in the direction of the wall hole, and put the drain pipe at the bottom, then bind the copper pipes and the drain pipe and the power cables together with the tape, so that water can flow away freely.

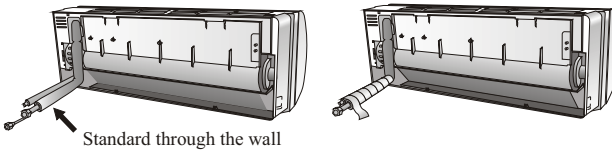
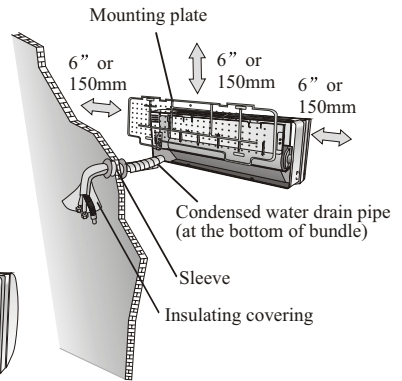

STEP 6:

Connecting Refrigerant Pipe

According to the wall hole position, select the appropriate piping mode.

There are three optional piping modes for indoor units as shown in the figure below:

In Piping Mode 1 or Piping Mode 3, a notch should be made by using scissors to cut the plastic sheet of piping outlet and cable outlet on the corresponding side of the indoor unit.

Note: When cutting off the plastic sheet at the outlet, the cut should be trimmed to smooth.

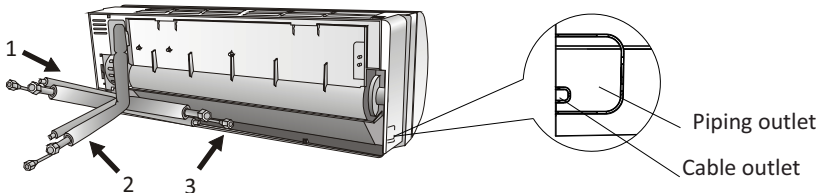

INSTALLATION MANUAL - Indoor Unit installation

STEP 7:

Unrolling the pipes

IMPORTANT

- Do not remove the cap from the pipe until connecting it, to avoid dampness or dirt from entering.
- If the pipe is bent or pulled too often, it will become stiff. Do not bend the pipe more than three times at one point.
- When extending the rolled pipe, straighten the pipe by unwinding it gently as shown in the picture.

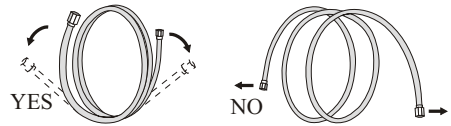

Extending the rolled pipe

- 7.1 Take off the plastic cover in the pipe ports and take off the protective cover on the end of piping connectors.
- 7.2 Check whether there is any sundry on the port of the connecting pipe and make ensure the port is clean.
- 7.3 After align the center, rotate the flare nut of the connecting pipe to tighten the flare nut as tightly as possible by hand.
- 7.4 Use a torque wrench to tighten it according to the torque values in the torque requirements table; (Refer to the torque requirements table on section **INSTALLATION PRECAUTIONS**)
- 7.5 Wrap the joint with the insulation pipe.

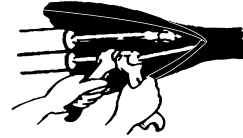

STEP 8:

Connect Drainage Hose

Adjust the drainage hose(if applicable)

In some model, both sides of the indoor unit are provided with drainage ports, you can choose one of them to attach the drainage hose.

And plug the unused drain port with the rubber attached in one of the ports.

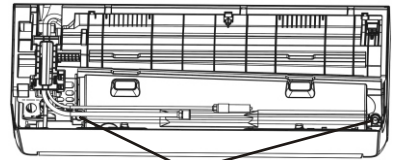

Drainage ports

Indoor unit condensate water drainage

By default, the drain hose is attached to the left-hand side of unit (when you're facing the back of the unit). However, it can also be attached to the right-hand side. To ensure proper drainage, attach the drain hose on the same side that your refrigerant piping exits the unit. Attach drain hose extension (purchased separately) to the end of drain hose.

- Wrap the connection point firmly with Teflon tape to ensure a good seal and to prevent leaks.
- For the portion of the drain hose that will remain indoors, wrap it with foam pipe insulation to prevent condensation.
- Remove the air filter and pour a small amount of water into the drain pan to make sure that water flows from the unit smoothly.

NOTE ON DRAIN HOSE PLACEMENT

Make sure to arrange the drain hose according to the following figures.



CORRECT



NOT CORRECT

Make sure there are no kinks or dent in drain hose to ensure proper drainage.



NOT CORRECT

Kinks in the drain hose will create water traps.



NOT CORRECT

Do not place the end of the drain hose in water or in containers that collect water. This will prevent proper drainage.

PLUG THE UNUSED DRAIN HOLE



o prevent unwanted leaks you must plug the unused drain hole with the rubber plug provided.

STEP 9:

Wiring Connection

! BEFORE PERFORMING ANY ELECTRICAL WORK, READ THESE REGULATIONS

1. All wiring must comply with local and national electrical codes, regulations and must be installed by a licensed electrician.
2. All electrical connections must be made according to the Electrical Connection Diagram located on the panels of the indoor and outdoor units.
3. If there is a serious safety issue with the power supply, stop work immediately. Explain your reasoning to the client, and refuse to install the unit until the safety issue is properly resolved.
4. Power voltage should be within 90-110% of rated voltage. Insufficient power supply can cause malfunction, electrical shock, or fire.
5. If connecting power to fixed wiring, a surge protector and main power switch should be installed.
6. If connecting power to fixed wiring, a switch or circuit breaker that disconnects all poles and has a contact separation of at least 1/8in (3mm) must be incorporated in the fixed wiring. The qualified technician must use an approved circuit breaker or switch.
7. Only connect the unit to an individual branch circuit outlet. Do not connect another appliance to that outlet.
8. Make sure to properly ground the air conditioner.
9. Every wire must be firmly connected. Loose wiring can cause the terminal to overheat, resulting in product malfunction and possible fire.

10. Do not let wires touch or rest against refrigerant tubing, the compressor, or any moving parts within the unit.
11. To avoid getting an electric shock, never touch the electrical components soon after the power supply has been turned off. After turning off the power, always wait 10 minutes or more before you touch the electrical components.

! WARNING

BEFORE PERFORMING ANY ELECTRICAL OR WIRING WORK, TURN OFF THE MAIN POWER TO THE SYSTEM.

Connect signal and power cables

The signal cable enables communication between the indoor and outdoor units. You must first choose the right cable size before preparing it for connection.

Cable Types

- Stranded Cable
- 16 AWG

NOTE: In North America, choose the cable type according to the local electrical codes and regulations.

NOTE: In North America, please choose the right cable size according to the Minimum Circuit Ampacity indicated on the nameplate of the unit.

Wiring Connection

- 9.1 Choose the right cables size determined by the maximum operating current on the nameplate. (Check the cables size refer to section **INSTALLATION PRECAUTIONS**)
- 9.2 Open the front panel of indoor unit.
- 9.3 Use a screwdriver, open the electric control box cover, to reveal the terminal block.
- 9.4 Unscrew the cable clamp.
- 9.5 Insert one end of the cable into the position of control box from the back of the right end of the indoor unit.
- 9.6 Connect the wires to corresponding terminal according to the wiring diagram on the electric control box cover. And make sure that they are well connected.
- 9.7 Screw the cable clamp to fasten the cables.
- 9.8 Reinstall the electric control box cover and front panel.

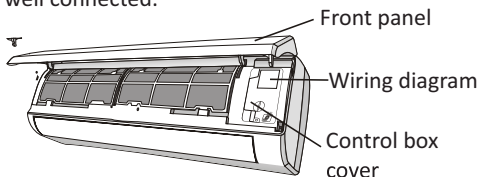

INSTALLATION MANUAL - Indoor Unit installation

STEP 10:

Wrap Piping and Cable

After the refrigerant pipes, connecting wires and drainage hose are all installed, in order to save space, protect and insulate them, it must be bundle with insulating tape before passing them through the wall hole.

10.1 Arrange the pipes ,cables and drainage hose well as the following picture.

- Note:** (I) Make sure the drainage hose is at the bottom.
(II) Avoid crossing and bending of parts.

10.2 Using the insulating tape wrap the refrigerant pipes, connecting wires and drainage hose together tightly.

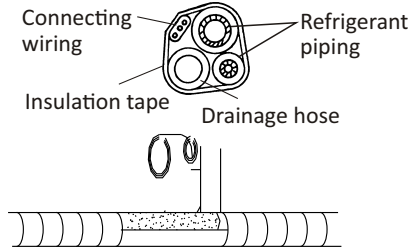

Mount Indoor Unit

- 10.1 Slowly pass the refrigerant pipes, connecting wires and drainage hose wrapped bundle through the wall hole.
- 10.2 Hook the top of indoor unit on the mounting plate.
- 10.3 Apply slight pressure to the left and right sides of the indoor unit, make sure the indoor unit is hooked firmly.
- 10.4 Push down the bottom of indoor unit to let the snaps onto the hooks of the mounting plate, and make sure it is hooked firmly.

If refrigerant piping is already embedded in the wall, do the following:

- 10.5 Hook the top of the indoor unit on the upper hook of the mounting plate.
- 10.6 Use a bracket or wedge to prop up the unit, giving you enough room to connect the refrigerant piping, signal cable, and drain hose.
- 10.9 After the leak test, wrap the connection point with insulation tape.
- 10.10 Remove the bracket or wedge that is propping up the unit.
- 10.11 Using even pressure, push down on the bottom half of the unit. Keep pushing down until the unit snaps onto the hooks along the bottom of the mounting plate.
- 10.7 Connect drain hose and refrigerant piping (refer to **Refrigerant Piping Connection** section of this manual for instructions).
- 10.8 Keep pipe connection point exposed to perform the leak test (refer to **Electrical Checks and Leak Checks** section of this manual).

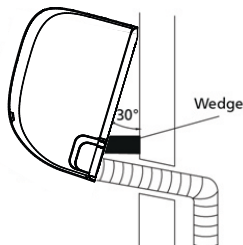

Unit is adjustable

Keep in mind that the hooks on the mounting plate are smaller than the holes on the back of the unit. If you find that you don't have ample room to connect embedded pipes to the indoor unit, the unit can be adjusted left or right by about 30-50mm (1.18-1.96in), depending on the model.

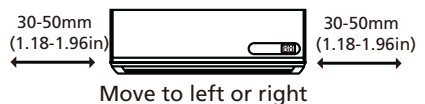

INSTALLATION MANUAL - Outdoor Unit installation

STEP 11:

Outdoor Unit Installation

Install the unit by following local codes and regulations, there may be differ slightly between different regions.

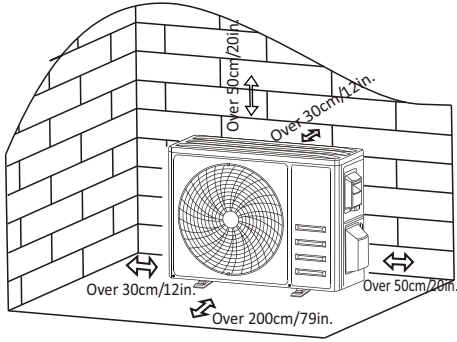

Installation Instructions – Outdoor unit

Step 1: Select installation location

Before installing the outdoor unit, you must choose an appropriate location. The following are standards that will help you choose an appropriate location for the unit.

Proper installation locations meet the following standards:

- ✓ Meets all spatial requirements shown in Installation Space Requirements above.
- ✓ Good air circulation and ventilation.
- ✓ Firm and solid—the location can support the unit and will not vibrate.
- ✓ Noise from the unit will not disturb others
- ✓ Protected from prolonged periods of direct sunlight or rain.
- ✓ Where snowfall is anticipated, take appropriate measures to prevent ice buildup and coil damage.

DO NOT install unit in the following locations:

- ⊘ Near an obstacle that will block air inlets and outlets
- ⊘ Near a public street, crowded areas, or where noise from the unit will disturb others
- ⊘ Near animals or plants that will be harmed by hot air discharge
- ⊘ Near any source of combustible gas In a location that is exposed to large amounts of dust
- ⊘ In a location exposed to a excessive amounts of salty air

SPECIAL CONSIDERATIONS FOR EXTREME WEATHER

If the unit is exposed to heavy wind:

Install unit so that air outlet fan is at a 90° angle to the direction of the wind. If needed, build a barrier in front of the unit to protect it from extremely heavy winds.

See Figures below.

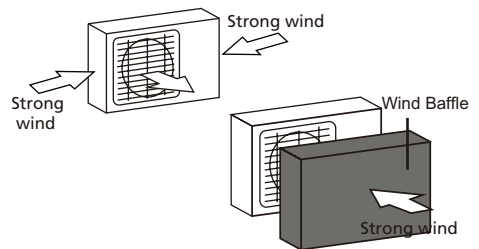

If the unit is frequently exposed to heavy rain or snow:

Build a shelter above the unit to protect it from the rain or snow. Be careful not to obstruct air flow around the unit.

If the unit is frequently exposed to salty air (seaside):

Use outdoor unit that is specially designed to resist corrosion.

INSTALLATION MANUAL - Outdoor Unit installation

Step 2: Install drain joint(Heat pump unit only)

Before bolting the outdoor unit in place, you must install the drain joint at the bottom of the unit. Note that there are two different types of drain joints depending on the type of outdoor unit.

If the drain joint comes with a rubber seal (see Fig. A), do the following:

1. Fit the rubber seal on the end of the drain joint that will connect to the outdoor unit.
2. Insert the drain joint into the hole in the base pan of the unit.
3. Rotate the drain joint 90° until it clicks in place facing the front of the unit.
4. Connect a drain hose extension (not included) to the drain joint to redirect water from the unit during heating mode.

If the drain joint doesn't come with a rubber seal (see Fig. B), do the following:

1. Insert the drain joint into the hole in the base pan of the unit. The drain joint will click in place.
2. Connect a drain hose extension (not included) to the drain joint to redirect water from the unit during heating mode.

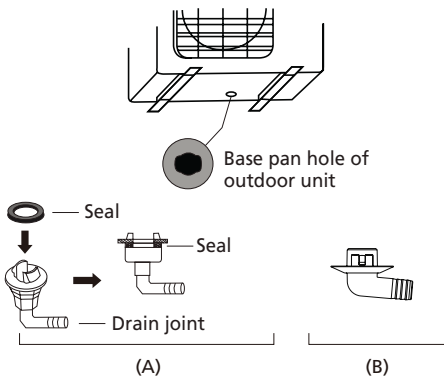

Step 3: Anchor outdoor unit

The outdoor unit can be anchored to the ground or to a wall-mounted bracket with bolt(M10). Prepare the installation base of the unit according to the dimensions below.

UNIT MOUNTING DIMENSIONS

The following is a list of different outdoor unit sizes and the distance between their mounting feet. Prepare the installation base of the unit according to the dimensions below.

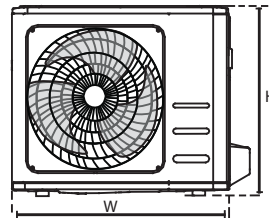
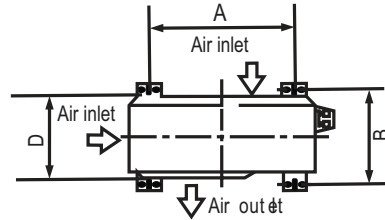

! IN COLD CLIMATES

In cold climates, make sure that the drain hose is as vertical as possible to ensure swift water drainage. If water drains too slowly, it can freeze in the hose and flood the unit.

INSTALLATION MANUAL - Outdoor Unit installation

Model Number	Outdoor Unit Dimensions (in) W x D x H	Mounting Dimensions	
		Distance A (in)	Distance B (in)
KOIU09H1-1T	728 x 305 x 550 (28.7" x 12.0" x 21.7")	434 (17.1")	278 (19.9")
KOIU12H1-1T	728 x 305 x 550 (28.7" x 12.0" x 21.7")	434 (17.1")	278 (19.9")
KOIU09H2-1T	728 x 305 x 550 (28.7" x 12.0" x 21.7")	434 (17.1")	278 (19.9")
KOIU12H2-1T	728 x 305 x 550 (28.7" x 12.0" x 21.7")	434 (17.1")	278 (19.9")
KOIU18H2-1T	845 x 380 x 699 (33.3" x 15.0" x 27.5")	586 (23.1")	347 (13.7")
KOIU24H2-1T	910 x 397 x 805 (35.8" x 15.6" x 31.7")	607 (23.9")	390 (15.4")
KOIU36H2-1T	910 x 360 x 800 (35.8" x 14.2" x 31.5")	607 (23.9")	421 (16.6")

If you will install the unit on the ground or on a concrete mounting platform, do the following:

- 11.1 Mark the positions for four expansion bolts based on dimensions chart.
- 11.2 Pre-drill holes for expansion bolts.
- 11.3 Place a nut on the end of each expansion bolt.
- 11.4 Hammer expansion bolts into the pre-drilled holes.
- 11.5 Remove the nuts from expansion bolts, if applicable install 4 rubber pads on the hole before placing the outdoor unit. and place outdoor unit on bolts.
- 11.6 Put washer on each expansion bolt, then replace the nuts.
- 11.7 Using a wrench, tighten each nut until snug.

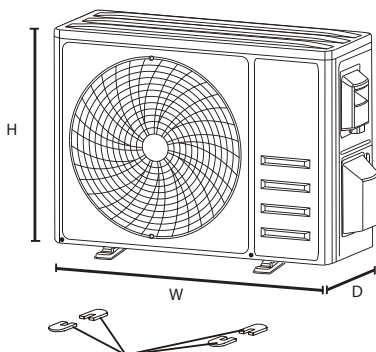

Install 4 rubber pads (Optional)

WARNING

WHEN DRILLING INTO CONCRETE, EYE PROTECTION IS RECOMMENDED AT ALL TIMES.

If you will install the unit on a wall-mounted bracket, do the following:

CAUTION

Make sure that the wall is made of solid brick, concrete, or of similarly strong material. The wall must be able to support at least four times the weight of the unit.

1. Mark the position of bracket holes based on dimensions chart.
2. Pre-drill the holes for the expansion bolts.
3. Place a washer and nut on the end of each expansion bolt.
4. Thread expansion bolts through holes in mounting brackets, put mounting brackets in position, and hammer expansion bolts into the wall.
5. Check that the mounting brackets are level.
6. Carefully lift unit and place its mounting feet on brackets.
7. Bolt the unit firmly to the brackets.
8. If allowed, install the unit with rubber gaskets to reduce vibrations and noise.

INSTALLATION MANUAL - Outdoor Unit installation

Refrigerant Piping Connection

When connecting refrigerant piping, **do not** let substances or gases other than the specified refrigerant enter the unit. The presence of other gases or substances will lower the unit's capacity, and can cause abnormally high pressure in the refrigeration cycle. This can cause explosion and injury.

Note on Pipe Length

The length of refrigerant piping will affect the performance and energy efficiency of the unit. Nominal efficiency is tested on units with a pipe length of 5 meters (16.5ft)(In North America, the standard pipe length is 7.5m (25'). A minimum pipe run of 3 metres is required to minimise vibration & excessive noise.

Refer to page 5 for maximum length and drop height of refrigerant piping per unit model

Recommended Installation Kit sizes

It is highly recommended to use factory pre-made Maxwell brand installation kits for easy and quick installation

Model Number	Liquid Line	Gas Line	Installation Kit 16'	Installation Kit 25'	Other Available Length
KOIU09H1-1 / KIWU09H1-1T	1/4"	3/8"	IKM1438F16-C17	IKM1438F25-C26	32' / 50'
KOIU12H1-1 / KIWU12H1-1T	1/4"	3/8"	IKM1438F16-C17	IKM1438F25-C26	32' / 50'
KOIU09H2-1 / KIWU09H2-1T	1/4"	3/8"	IKM1438F16-C17	IKM1438F25-C26	32' / 50'
KOIU12H2-1 / KIWU12H2-1T	1/4"	3/8"	IKM1438F16-C17	IKM1438F25-C26	32' / 50'
KOIU18H2-1 / KIWU18H2-1T	1/4"	3/8"	IKM1438F16-C17	IKM1438F25-C26	32' / 50'
KOIU24H2-1 / KIWU24H2-1T	1/4"	1/2"	IKM1412F16-C17	IKM1412F25-C26	32' / 50'
KOIU36H2-1 / KIWU36H2-1T	1/4"	5/8"	IKM1458F16-C17	IKM1458F16-C17	32' / 50'

Connection Instructions – Refrigerant Piping

Step 1: Cut pipes

When preparing refrigerant pipes, take extra care to cut and flare them properly. This will ensure efficient operation and minimize the need for future maintenance.

1. Measure the distance between the indoor and outdoor units.
2. Using a pipe cutter, cut the pipe a little longer than the measured distance.
3. Make sure that the pipe is cut at a perfect 90° angle.

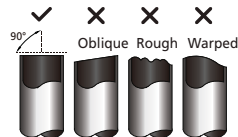

DO NOT DEFORM PIPE WHILE CUTTING

Be extra careful not to damage, dent, or deform the pipe while cutting. This will drastically reduce the heating efficiency of the unit.

INSTALLATION MANUAL - Outdoor Unit installation

Step 2: Remove burrs

Burrs can affect the air-tight seal of refrigerant piping connection. They must be completely removed.

1. Hold the pipe at a downward angle to prevent burrs from falling into the pipe.
2. Using a reamer or deburring tool, remove all burrs from the cut section of the pipe.

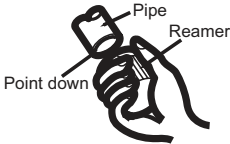

Step 3: Flare pipe ends

Proper flaring is essential to achieve an airtight seal.

1. After removing burrs from cut pipe, seal the ends with PVC tape to prevent foreign materials from entering the pipe.
2. Sheath the pipe with insulating material.
3. Place flare nuts on both ends of pipe. Make sure they are facing in the right direction, because you can't put them on or change their direction after flaring.

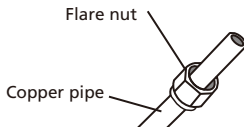

4. Remove PVC tape from ends of pipe when ready to perform flaring work.
5. Clamp flare form on the end of the pipe. The end of the pipe must extend beyond the edge of the flare form in accordance with the dimensions shown in the table below.

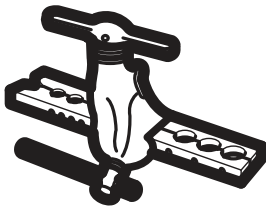

PIPING EXTENSION BEYOND FLARE FORM

Outer Diameter of Pipe (mm/in)	A (mm)	
	Min.	Max.
Ø 6.35 (1/4")	0.7 (0.0275")	1.3 (0.05")
Ø 9.52 (3/8")	1.0 (0.04")	1.6 (0.063")
Ø 12.7 (1/2")	1.0 (0.04")	1.8 (0.07")
Ø 16 (5/8")	2.0 (0.078")	2.2 (0.086")
Ø 19 (3/4")	2.0 (0.078")	2.4 (0.094")

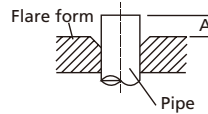

6. Place flaring tool onto the form.
7. Turn the handle of the flaring tool clockwise until the pipe is fully flared.
8. Remove the flaring tool and flare form, then inspect the end of the pipe for cracks and even flaring.

Step 4: Connect pipes

When connecting refrigerant pipes, be careful not to use excessive torque or to deform the piping in any way. You should first connect the low-pressure pipe, then the high-pressure pipe.

MINIMUM BEND RADIUS

When bending connective refrigerant piping, the minimum bending radius is 10cm.

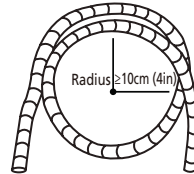

Instructions for Connecting Piping to Indoor Unit

1. Align the center of the two pipes that you will connect.

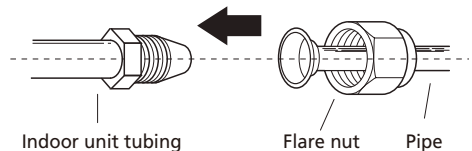

INSTALLATION MANUAL - Outdoor Unit installation

2. Tighten the flare nut as tightly as possible by hand.
3. Using a spanner, grip the nut on the unit tubing.
4. While firmly gripping the nut on the unit tubing, use a torque wrench to tighten the flare nut according to the torque values in the **Torque Requirements** table below. Loosen the flaring nut slightly, then tighten again.

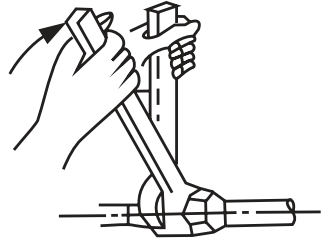

TORQUE REQUIREMENTS

PIPE Size	Newton meter[N x m]	Pound-force foot (lbf-ft)	Kilogram-force meter (kgf-m)
1/4 " (ϕ 6.35)	18 - 20	24.4 - 27.1	2.4 - 2.7
3/8 " (ϕ 9.52)	30 - 35	40.6 - 47.4	4.1 - 4.8
1/2 " (ϕ 12)	45 - 50	61.0 - 67.7	6.2 - 6.9
5/8 " (ϕ 15.88)	60 - 65	81.3 - 88.1	8.2 - 8.9

⊘ DO NOT USE EXCESSIVE TORQUE

Excessive force can break the nut or damage the refrigerant piping. You must not exceed torque requirements shown in the table above.

Instructions for Connecting Piping to Outdoor Unit

1. Unscrew the cover from the packed valve on the side of the outdoor unit.
2. Remove protective caps from ends of valves.
3. Align flared pipe end with each valve, and tighten the flare nut as tightly as possible by hand.
4. Using a spanner, grip the body of the valve. Do not grip the nut that seals the service valve.
5. While firmly gripping the body of the valve, use a torque wrench to tighten the flare nut according to the correct torque values.
6. Loosen the flaring nut slightly, then tighten again.
7. Repeat Steps 3 to 6 for the remaining pipe.

⚠ USE SPANNER TO GRIP MAIN BODY OF VALVE

Torque from tightening the flare nut can snap off other parts of valve.

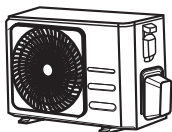

Valve cover

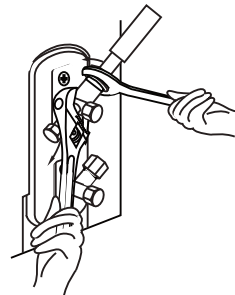

5. While firmly gripping the body of the valve, use a torque wrench to tighten the flare nut according to the correct torque values.

MANIFOLD AND GAUGES

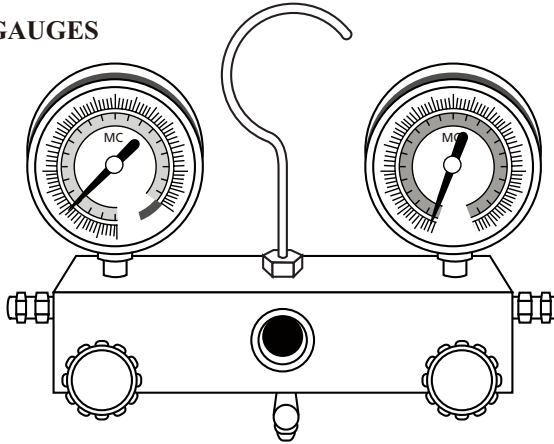

Preparations and Precautions

Air and foreign matter in the refrigerant circuit can cause abnormal rises in pressure, which can damage the air conditioner, reduce its efficiency, and cause injury. Use a vacuum pump and manifold gauge to evacuate the refrigerant circuit, removing any non-condensable gas and moisture from the system. Evacuation should be performed upon initial installation and when unit is relocated.

BEFORE PERFORMING EVACUATION

- ✓ Check to make sure the connective pipes between the indoor and outdoor units are connected properly.
- ✓ Check to make sure all wiring is connected properly.

Evacuation Instructions

1. Connect the charge hose of the manifold gauge to service port on the outdoor unit's low pressure valve.
2. Connect another charge hose from the manifold gauge to the vacuum pump.
3. Open the Low Pressure side of the manifold gauge. Keep the High Pressure side closed.
4. Turn on the vacuum pump to evacuate the system.
5. Run the vacuum for at least 15 minutes, or until the Compound Meter reads -76cmHG (-10⁵ Pa). (-14.5 psi)

8. If there is a change in system pressure, refer to Gas Leak Check section for information on how to check for leaks. If there is no change in system pressure, unscrew the cap from the packed valve (high pressure valve).
9. Insert hexagonal wrench into the packed valve (high pressure valve) and open the valve by turning the wrench in a 1/4 counterclockwise turn. Listen for gas to exit the system, then close the valve after 5 seconds.
10. Watch the Pressure Gauge for one minute to make sure that there is no change in pressure. The Pressure Gauge should read slightly higher than atmospheric pressure.
11. Remove the charge hose from the service port.

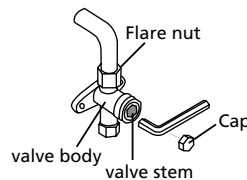

12. Using hexagonal wrench, fully open both the high pressure and low pressure valves.
13. Tighten valve caps on all three valves (service port, high pressure, low pressure) by hand. You may tighten it further using a torque wrench if needed.

! OPEN VALVE STEMS GENTLY

When opening valve stems, turn the hexagonal wrench until it hits against the stopper. Do not try to force the valve to open further.

INSTALLATION MANUAL - Refrigerant

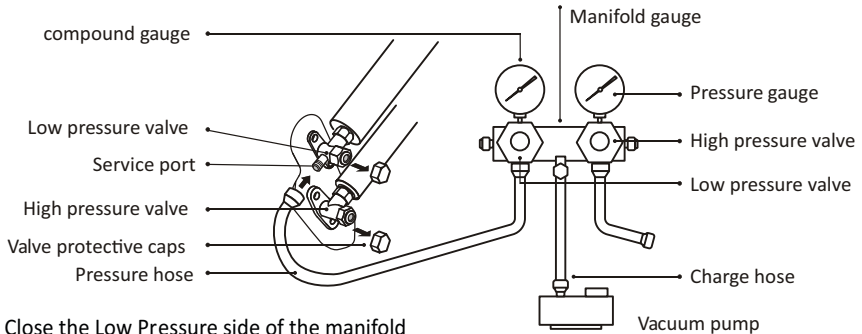

6. Close the Low Pressure side of the manifold gauge, and turn off the vacuum pump.
7. Wait for 5 minutes, then check that there has been no change in system pressure.

Note on Adding Refrigerant

Some systems require additional charging depending on pipe lengths. The standard pipe length varies according to local regulations. For example, in North America, the standard pipe length is 7.5m (25'). The refrigerant should be charged from the service port on the outdoor unit's low pressure valve. The additional refrigerant to be charged can be calculated using the following formula:

ADDITIONAL REFRIGERANT PER PIPE LENGTH

Connective Pipe Length (m)	Air Purging Method	Additional Refrigerant				
≤ Standard pipe length	Vacuum Pump	N/A				
> Standard pipe length	Vacuum Pump	Length of pipe with standard charge (Like: North American, etc)	7.5m/24ft	7.5m/24ft	7.5m/24ft	7.5m/24ft
		Additional refrigerant charge	0.22oz/ft	0.16oz/ft	0.32oz/ft	0.27oz/ft
		Type of refrigerant	R410A	R32	R410A	R32



CAUTION DO NOT mix refrigerant types.

Electrical and Gas Leak Checks

Before Test Run

Only perform test run after you have completed the following steps:

- **Electrical Safety Checks** – Confirm that the unit's electrical system is safe and operating properly
- **Gas Leak Checks** – Check all flare nut connections and confirm that the system is not leaking
- Confirm that gas and liquid (high and low pressure) valves are fully open

Electrical Safety Checks

After installation, confirm that all electrical wiring is installed in accordance with local and national regulations, and according to the Installation Manual.

BEFORE TEST RUN

Check Grounding Work

Measure grounding resistance by visual detection and with grounding resistance tester. Grounding resistance must be less than 0.1Ω .

Note: This may not be required for some locations in North America.

DURING TEST RUN

Check for Electrical Leakage

During the **Test Run**, use an electroprobe and multimeter to perform a comprehensive electrical leakage test.

If electrical leakage is detected, turn off the unit immediately and call a licensed electrician to find and resolve the cause of the leakage.

Note: This may not be required for some locations in North America.



WARNING – RISK OF ELECTRIC SHOCK

ALL WIRING MUST COMPLY WITH LOCAL AND NATIONAL ELECTRICAL CODES, AND MUST BE INSTALLED BY A LICENSED ELECTRICIAN.

Gas Leak Checks

There are two different methods to check for gas leaks.

Soap and Water Method

Using a soft brush, apply soapy water or liquid detergent to all pipe connection points on the indoor unit and outdoor unit. The presence of bubbles indicates a leak.

Leak Detector Method

If using leak detector, refer to the device's operation manual for proper usage instructions.

AFTER PERFORMING GAS LEAK CHECKS

After confirming that all pipe connection points **DO NOT** leak, replace the valve cover on the outside unit.

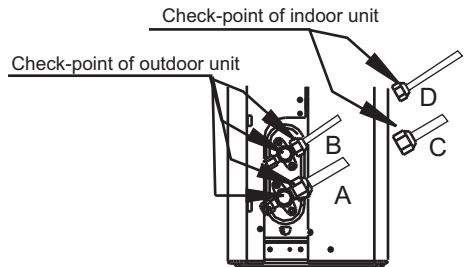

A: Low pressure stop valve
B: High pressure stop valve
C & D: Indoor unit flare nuts

Test Operation

Test Operation Instructions

You should perform the **Test Operation** for at least 30 minutes.

1. Connect power to the unit.
2. Press the **ON/OFF** button on the remote controller to turn it on.
3. Press the **MODE** button to scroll through the following functions, one at a time:
 - **COOL** – Select lowest possible temperature
 - **HEAT** – Select highest possible temperature
4. Let each function run for 5 minutes, and perform the following checks:

List of Checks to Perform	PASS/FAIL	
No electrical leakage		
Unit is properly grounded		
All electrical terminals properly covered		
Indoor and outdoor units are solidly installed		
All pipe connection points do not leak	Outdoor (2):	Indoor (2):
Water drains properly from drain hose		
All piping is properly insulated		
Unit performs COOL function properly		
Unit performs HEAT function properly		
Indoor unit louvers rotate properly		
Indoor unit responds to remote controller		

DOUBLE-CHECK PIPE CONNECTIONS

During operation, the pressure of the refrigerant circuit will increase. This may reveal leaks that were not present during your initial leak check. Take time during the Test Run to double-check that all refrigerant pipe connection points do not have leaks. Refer to **Gas Leak Check** section for instructions.

5. After the Test Run is successfully completed, and you confirm that all checks points in List of Checks to Perform have PASSED, do the following:
 - a. Using remote control, return unit to normal operating temperature.
 - b. Using insulation tape, wrap the indoor refrigerant pipe connections that you left uncovered during the indoor unit installation process.

IF AMBIENT TEMPERATURE IS BELOW 17°C (62°F)

You can't use the remote controller to turn on the COOL function when the ambient temperature is below 17°C. In this instance, you can use the **MANUAL CONTROL** button to test the COOL function.

1. Lift the front panel of the indoor unit, and raise it until it clicks in place.
2. The **MANUAL CONTROL** button is located on the right-hand side of the unit. Press it 2 times to select the COOL function.
3. Perform Test Run as normal.

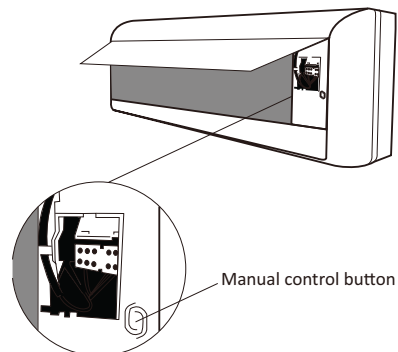

KLIMAIRE™ ≈

Mark of Superior Quality

7999NW 81 Place - Medley, FL 33166

Tel: (305) 593 - 8358

www.klimaire.com

customerservice@klimaire.com

The Klimaire logo is a registered Trademark of Klimaire Products Inc.
Copyright 2023 Klimaire Products Inc.

The design and specifications are subject to change without prior notice for product improvement. Consult with the sales agency or manufacturer for details.