

# KIWQ/KOIQ

*SERIES*

***SPLIT-TYPE ROOM AIR CONDITIONER***

---

## Installation Manual

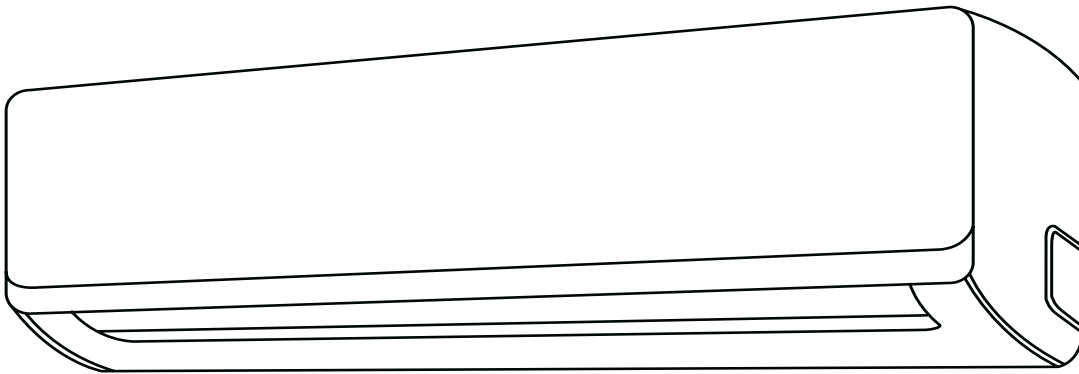

**KLIMAIRE<sup>®</sup>** ≈  
Mark of Superior Quality

**IMPORTANT NOTE:**

Read this manual carefully before installing or operating your new air conditioning unit. Make sure to save this manual for future reference.

For more information please visit [www.klimaire.com](http://www.klimaire.com)

## CONTENTS

### Installation

<b>1. Notes for installation and maintenance .....</b>	<b>3</b>
<b>2.Installation .....</b>	<b>10</b>
<b>2.1 Installation Dimension Diagram .....</b>	<b>10</b>
<b>2.2 Accessory .....</b>	<b>11</b>
<b>2.3 Tools .....</b>	<b>11</b>
<b>2.4 Position .....</b>	<b>12</b>
<b>2.5 Electricity and wiring .....</b>	<b>12</b>
<b>2.6 IDU Installation .....</b>	<b>12</b>
<b>2.7 ODU Installation .....</b>	<b>15</b>
<b>2.8 Vacuum and gas leakage test .....</b>	<b>16</b>
<b>2.9 Final test .....</b>	<b>16</b>

## Installation Manual

### 1. Notes for installation and maintenance Safety Precautions

#### Important!

Please read the safety of precautions carefully before installation and maintenance. The following contents are very important for installation and maintenance. Please follow the instructions below.

- The installation or maintenance must accord with the instructions.
- Comply with all national electrical codes and local electrical codes.
- Pay attention to the warnings and cautions in this manual.
- All installation and maintenance shall be performed by distributor or qualified person.
- All electric work must be performed by licensed technician according to local regulations and instructions given in this manual.
- Be caution during installation and maintenance. Prohibit incorrect operation to prevent electric shock, casualty and other accidents.

## Warnings

### Electrical safety Precautions.

- 1) Cut off the power supply of air conditioner before checking and maintenance.
- 2) The air conditioner must apply specialized circuit and prohibit share the same circuit with other appliances.
- 3) The air conditioner should be installed in suitable location and ensure the power plug is touchable.
- 4) Make sure each wiring terminal is connected firmly during installation and maintenance.
- 5) Have the unit adequately grounded. The grounding wire can't be used for other purposes.
- 6) Must apply protective accessories such as protective boards, cable-cross loop and wire clip.
- 7) The live wire, neutral wire and grounding wire of power supply must be corresponding to the live wire, neutral wire and grounding wire of the air conditioner.
- 8) The power cord and power connection wires can't be pressed by hard objects.
- 9) If power cord or connection wire is broken, it must be replaced by qualified person.
- 10) If the power cord or connection wire is not long enough, please get the specialized power cord or connection wire from the manufacture or distributor. Prohibit prolong the wire by yourself.
- 11) For the air conditioner without plug, an air switch must be installed in the circuit. The air switch should be all-pole parting and the contact parting distance should be more then 3mm.
- 12) Make sure all wires and pipes are connected properly and the valves are opened before energizing.
- 13) Check if there is electric leakage on the unit body. If yes, please eliminate the electric leakage.
- 14) Replace the fuse with a new one of the same specification if it is burnt down, don't replace it with a cooper wire or conducting wire.
- 15) If the unit is to be installed in a humid place, the circuit breaker must be installed.

### Installation Safety Precaution

- 1) Select the installation location according to the requirement of this manual. (See the requirements in installation part).
- 2) Handle unit transportation with care, the unit should not be carried by only one person if it is more than 20kg.
- 3) When installing the indoor unit and outdoor unit, a sufficient fixing bolt must be installed, make sure the installation supporter is firm.
- 4) Wear safety belt if the height of working is above 2m.
- 5) Use equipped components or appointed components during installation.

6) Make sure no foreign objects are left in the unit after finishing installation.

## Improper installation may lead to fire hazard, explosion, electric shock or injury.

Safety precautions for Installing and Relocating the unit.

To ensure safety, please be mindful of the following precautions.

### Warnings

When installing or relocating the unit, be sure to keep the refrigerant circuit free from air or substances other than the specified refrigerant.

Any presence of air or other foreign substance in the refrigerant circuit will cause system pressure rise or compressor rupture, resulting in injury.

When installing or moving this unit, do not charge the refrigerant which is not comply with that on the nameplate or unqualified refrigerant.

Otherwise, it may cause abnormal operation, wrong action, mechanical malfunction or even series safety accident.

When refrigerant needs to be recovered during relocating or repairing the unit, be sure that the unit is running in cooling mode. Then, fully close the valve at high pressure side (two-way valve). About 30-40 seconds later, fully close the valve at low pressure side (3-way valve), immediately stop the unit and disconnect power. Please note that the time for refrigerant recover should not exceed 1 minute.

If refrigerant recovery takes too much time, may be cause compressor overheat, resulting in injury.

During refrigerant recovery, make sure that two-way valve and 3-way valve are fully closed and power is disconnected before detaching the connecting pipe.

If compressor starts running when the valves is open and connecting pipe is not yet connected, air will be sucked in and cause pressure rise and then compressor overheat or gas leak, resulting in injury.

When installing the unit, make sure that connecting pipe is securely connected before the compressor starts running.

If compressor starts running when the valves is open and connecting pipe is not yet connected, air will be sucked in and cause pressure rise and then compressor overheat or gas leak, resulting in injury.

Prohibit installing the unit at the place where there may be leaked corrosive gas or flammable gas.

If there leaked gas around the unit, it may cause explosion and other accidents.

Do not use extension cords for electrical connections. If the electric wire is not long enough, please contact a local service center authorized and ask for a proper electric wire.

Poor connection may lead to electric shock or fire.

Use the specified types of wires for electrical connections between the indoor and outdoor units. Firmly clamp the wires so that their terminals receive no external stresses.

Electric wires with insufficient capacity, wrong wire connections and insecure wire terminals may cause electric shock or fire.

## Introduction R32, R290 air conditioner installation

### Introduction to Refrigerants R32 & R290

The refrigerants used for air conditioners are environmentally friendly hydrocarbons R32 and R290. The two kinds of refrigerants are combustible and odorless. Moreover, they can burn and explode under certain condition. However, there will be no risk of burning and explosion if you comply with the following table to install your air conditioner in a room with an appropriate area and use it correctly.

Compared with ordinary refrigerants, Refrigerants R32 & R290 are environmentally friendly and do not destroy the ozone sphere and that their values of greenhouse effect are also very low.

### R32/R290 air conditioner installation area requirement

$$m1=(4m^3)\times LFL, m2=(26m^3)\times LFL, m3=(130m^3)\times LFL$$

Where LFL is the lower flammable limit in kg/m<sup>3</sup>, R290 LFL is 0.038kg/m<sup>3</sup>, R32 LFL is 0.306kg/m<sup>3</sup>.

#### **For the appliances with a charge amount $m1 < M < m2$ :**

The maximum charge in a room shall be in accordance with the flowing:  $M_{max}=2.5\times(LFL)^{(5/4)}\times h_0\times A^{1/2}$

The required minimum floor area  $A_{min}$  to install an appliance with refrigerant charge  $M$ (kg) shall be in accordance with following:  $A_{min}=(M/(2.5\times(LFL)^{(5/4)}\times h_0))^2$

Where:

$M_{max}$  is the allowable maximum charge in a room, in kg;

$M$  is the refrigerant charge amount in appliance, in kg;

$A_{min}$  is the required minimum room area, in m<sup>2</sup>;

A is the room area, in m<sup>2</sup>;

LFL is the lower flammable limit, in kg/m<sup>3</sup>;

h<sub>0</sub> is the installation height of the appliance, in meters for calculating M<sub>max</sub> or A<sub>min</sub>, 1.8 m for wall mounted;

**Table GG.1 - Maximum charge (kg)**

Category	LFL (kg/m <sup>3</sup> )	h <sub>0</sub> (m)	Floor area (m <sup>2</sup> ) Maximum charge (kg)						
			4	7	10	15	20	30	50
R290	0.038	0.6	0.05	0.07	0.08	0.1	0.11	0.14	0.18
		1	0.08	0.11	0.03	0.06	0.09	0.2	0.3
		1.8	0.15	0.2	0.24	0.29	0.34	0.41	0.53
		2.2	0.18	0.24	0.29	0.36	0.41	0.51	0.65
R32	0.306	0.6	0.68	0.9	1.08	1.32	1.53	1.87	2.41
		1	1.14	1.51	1.8	2.2	2.54	3.12	4.02
		1.8	2.05	2.71	3.24	3.97	4.58	5.61	7.254
		2.2	2.5	3.31	3.96	4.85	5.6	6.86	8.85

**Table GG.2 - Minimum room area (m<sup>2</sup>)**

Category	LFL (kg/m <sup>3</sup> )	h <sub>0</sub> (m)	Charge amount (M) (kg) Minimum room area (m <sup>2</sup> )						
			0.152kg	0.228kg	0.304kg	0.456kg	0.608kg	0.76kg	0.988kg
R290	0.038		/	82	146	328	584	912	1514
		0.6	/	30	53	118	210	328	555
		1	/	9	16	36	65	101	171
		1.8	/	6	11	24	43	68	115
		2.2	/	2	4	9	15	24	40
R32	0.306		1.224kg	1.836kg	2.448kg	3.672kg	4.896kg	6.12kg	7.956kg
		0.6	/	29	51	116	206	321	543
		1	/	10	19	42	74	116	196
		1.8	/	3	6	13	23	36	60
		2.2	/	2	4	9	15	24	40

**Caution:**

- Please contact the nearest after-sale service center when maintenance is necessary. At the time of maintenance, the maintenance personnel must strictly comply with the Operation Manual provided by the corresponding manufacturer and any non-professional is prohibited to maintain the air conditioner.
- It is necessary to comply with the provisions of gas-related national laws and regulations.
- It is necessary to clear away the refrigerant in the system when maintaining or scrapping an air conditioner.
- When filling the combustible refrigerant, any of your rude operations may cause serious injury or injuries to human body or bodies and object or objects.
- A leak test must be done after the installation is completed.
- It is a must to do the safety inspection before maintaining or repairing an air conditioner using combustible refrigerant in order to ensure that the fire risk is reduced to minimum.

## 1) Installation Safety

### Installation Safety Principles

#### Site Safety



Open Flames Prohibited



Ventilation Necessary

#### Operation Safety

Open Flames Prohibited



Mind Static Electricity    Must wear protective clothing and anti-static gloves    Don't use mobile phone

#### Installation Safety

- Refrigerant Leak Detector
- Appropriate Installation Location



The left picture is the schematic diagram of a refrigerant leak detector.

### Installation Safety Caution:

- The installation should be in a well-ventilated condition location.
- When you installing or maintaining an air conditioner using Refrigerant R32/R290, the location should be free fire from open or any other goods temperature higher than 370 °C for R290/548 °C for R32 which easily produces open fire include welding, smoking, drying oven.
- When installing an air conditioner of R32/R290, it is necessary to take appropriate anti-static measures such as wear anti-static clothing and gloves.
- It is necessary to choose the location for installation or maintenance where in the air inlets and outlets of the indoor and outdoor units should be not surrounded by obstacles or close to any heat source or combustible and/or explosive environment.
- If the indoor unit suffers refrigerant leak during the installation, it is necessary to immediately turn off the valve of the outdoor unit and all the personnel should go out till the refrigerant leaks completely for 15 minutes. If the product is damaged, it is a must to carry such damaged product back to the maintenance station and it is prohibited to weld the refrigerant pipe or conduct other operations on the user's site.
- It is necessary to choose the place where the inlet and outlet air of the indoor unit is even.
- It is necessary to avoid the places where there are other electrical products, power switch plugs and sockets, kitchen cabinet, bed, sofa and other valuables right under the lines on two sides of the indoor unit.

### Special tools:

Tool Name	Requirement(s) for Use
Mini Vacuum Pump	It should be an explosion-proof vacuum pump; can ensure certain precision and its vacuum degree should be lower than 10Pa.

Filling Device	It should be a special explosion-proof filling device; have certain precision and its filling deviation should be less than 5g.
Leak Detector	It should be calibrated regularly; and its annual leak rate should not exceed 10g.
Concentration Detector	<p>A) The maintenance site should be equipped with a fixed-type combustible refrigerant concentration detector and connected to a safeguard alarm system; its error must be not more than 5%.</p> <p>B) The installation site should be equipped with a portable combustible refrigerant concentration detector which can realize two-level audible and visual alarm; its error must be not more than 10%.</p> <p>C) The concentration detectors should be calibrated regularly.</p> <p>D) It is necessary to check and confirm the functions before using the concentration detectors.</p>
Pressure Gauge	<p>A) The pressure gauges should be calibrated regularly.</p> <p>B) The pressure gauge used for Refrigerant 22 can be used for Refrigerants R290 and R161; the pressure gauge used for R410A can be used for Refrigerant 32.</p>
Fire Extinguisher	It is necessary to carry fire extinguisher(s) when installing and maintaining an air conditioner. On the maintenance site, there should be two or more kinds of dry powder, carbon dioxide and foam fire extinguishers and that such fire extinguishers should be placed at stipulated positions, with eye-catching labels and in handy places.

## Maintenance

### 1). Inspections before maintenance.

#### (1) Inspection of maintenance environment

- There should be no leaked refrigerant in the room before operation.
- It is only allowed to operate in a room which meets the area requirement on the nameplate.
- It is necessary to make the room keep a continuous ventilation state at the time of maintenance.
- The room in the maintenance should be free from fire or welding, smoking, drying oven or any other goods temperature higher than 370°C (R290)/548°C (R32) which easily produces fire.
- During the maintenance, it is necessary to ensure that any person's any mobile phone or any electronic product with radiation in the room is powered off.
- The maintenance area should be equipped with a drying powder or carbon dioxide fire extinguisher and that such fire extinguisher can work.

#### (2) Inspection of maintenance equipment

- Check the maintenance equipment is applicable to the refrigerant or not and it is only allowed to use the professional equipment recommended by the air conditioner manufacturer.
- Check the refrigerant leak detector whether has been calibrated. The set maximum alarm concentration of the refrigerant leak detector should not exceed 25% of the lower explosion limit (LEL), the refrigerant leak detector must be working during maintenance.

### 2) Inspection of air conditioner

- It is necessary to ensure that the air conditioner is in reliable ground connection before maintenance.
- Make sure powered supply to air conditioner is off. Before maintenance, it is necessary to cut off the power and discharge the capacitor power which used in the air conditioner. If it is a must to need the power supply during the maintenance, it is necessary to do ongoing leak detection at the most dangerous position/point in order to avoid potential danger.
- Check the warning labels on the air conditioner whether are in good condition. It is necessary to replace

the damaged or smeared warning labels.

### 3). Leak inspection before maintenance

Before maintenance, use the leak detector or concentration detector (pump-type) recommended by the corresponding air conditioner manufacturer to check the air conditioner leak or not.

#### **Warning**

If leak may exist, it is necessary to move all the fire out from the site or extinguish fire and then immediately shut off the air conditioner. Meanwhile, it is necessary to make sure well-ventilated.

### 4). Safety principles during the maintenance

- At the time of maintenance, it is necessary to ensure well-ventilation on the site.
- It is prohibited to use fire including welding, smoking or other purposes. It is prohibited to use mobile phones.
- At the time of maintenance, if the relative humidity is lower than 40%, it is necessary to wear anti-static clothing and gloves.
- If the combustible refrigerant is found leaking during the maintenance, it is a must to immediately take forced ventilation and plug up the leak source.
- If the product is damaged to the extent that it is a must to open the refrigerating system for maintenance, it is a must to carry the product back to the maintenance station for maintenance. (It is prohibited to weld the refrigerant pipe and do other operations on the user's site.)
- It is necessary to return the air conditioner to its initial state if it is necessary to provide visiting service again due to lacking spare part during the maintenance. Moreover, it is a must to ensure that the refrigerating system is in secure ground connection.
- If it is necessary to provide visiting service with a refrigerant cylinder, the volume of refrigerant filled in such refrigerant cylinder should not exceed the stipulated value. When such cylinder is stored in a vehicle or placed on the installation or maintenance site, it is necessary to place it vertically and securely and keep it away from any place where there is any heat source, combustion source, radiation source or electrical equipment.

### 5). Requirements for the site of maintenance-station

- The maintenance location should be well-ventilated, with leveled ground and not in a basement.
- The maintenance should be divided into welding and non-welding areas both of which should be labeled clearly. There should be a certain safety distance between the two areas. The maintenance location should be equipped with ventilating and air-exhausting equipment to prevent the refrigerant gas from aggregating.
- It is necessary to provide some relevant instruments such as combustible refrigerant leak detector and have a leak detecting instrument management system. It is necessary to confirm that the leak detector can work normally before maintenance.
- The main power switch should be set outside the maintenance location and equipped with protective (explosion-proof) devices.
- It is necessary to provide firefighting devices such as dry powder or carbon dioxide fire extinguisher appropriate for extinguishing the electrical fire and keep such firefighting devices in a usable condition.
- Temporary wires and sockets are prohibited on the maintenance location.

### 6). Requirements for fill the refrigerants

- It is necessary to use nitrogen to clear the cyclic system before operating the refrigerating system and vacuumize the outdoor unit for 30 minutes at least.
- It is necessary to ensure that there is no cross contamination among different refrigerants when the refrigerant filling device is used. The total length including the refrigerant pipeline should be as short



as possible in order to reduce the residual refrigerant inside such pipeline.

- It is necessary to vertically place the refrigerant storage tanks.
- It is necessary to ensure that the refrigerating system is in ground connection before the refrigerant is filled.
- When filling the refrigerant, it is necessary to fill corresponding type and volume of refrigerant as per the requirements on the product nameplate and overfilling is prohibited.
- It is necessary to seal the system in a safe sealing way after maintaining the refrigerating system.
- It is necessary to ensure that the maintenance will not damage or reduce the safety protection grade of the original system.

### **7). In-maintenance welding**

- It is necessary to ensure that the maintenance location is well-ventilated.
- Before welding the outdoor unit, it is a must to confirm that the refrigerating system has been drained and the system has been cleaned and ensure that there has been no refrigerant in the outdoor unit.
- It is necessary to close the stop valve of the outdoor unit when using a welding gun to do the maintenance work such as cutting and welding.

### **8). Maintenance of electrical components**

- It is necessary to use a special leak detector to check whether the maintained electrical parts location have the leak refrigerant.
- It is not allowed to refit, remove or cancel any component with the safety protection function after finishing the maintenance process.
- When maintaining the sealed parts, it is necessary to turn off the power of air conditioner before opening the sealing cover. When power supply is needed, it is necessary to do the ongoing leak detection at the most dangerous position in order to prevent potential danger.
- It is necessary to specially note that the maintenance of electrical components will not affect the replacement of protective cover.
- In order to ensure that the sealing function is not damaged after maintenance or the sealing material will not lose the effect of preventing the combustible gas leak due to ageing. So the substitute components should meet the requirements recommended by the air conditioner manufacturer.

## **Warning**

Before doing the trial operation after finishing the maintenance, it is a must to use a practical leak detector to inspect the leakage and reliability of ground connection in order to ensure that no refrigerant leakage and reliable ground connection.

The refrigerant storage tanks should be separately placed in a well-ventilated place at the temperature ranging from -10°C to 50°C and label them with warning labels.

### **9). Emergency Accident Handling**

A maintenance station should establish emergency handling plans. It is necessary to take appropriate precautionary measures in work. For example, it is prohibited to enter the location with any kindling material and it is prohibited to wear clothing or shoes which easily produce static.

Handling suggestions when a large amount of combustible refrigerant leaks:

- It is necessary to immediately operate the ventilating equipment while cutting off other power supply and evacuating the affected personnel urgently from the location.
- It is necessary to inform near residents of evacuating for over 20 meters from the location, make an alarm call, set the emergency area and prohibit irrelevant personnel and vehicles from approaching.
- The professional firefighters should wear anti-static clothing to handle the emergency on the site and cut off the source of leak.
- It is necessary to use nitrogen for blowing the site, especially the low-lying positions, clear away the





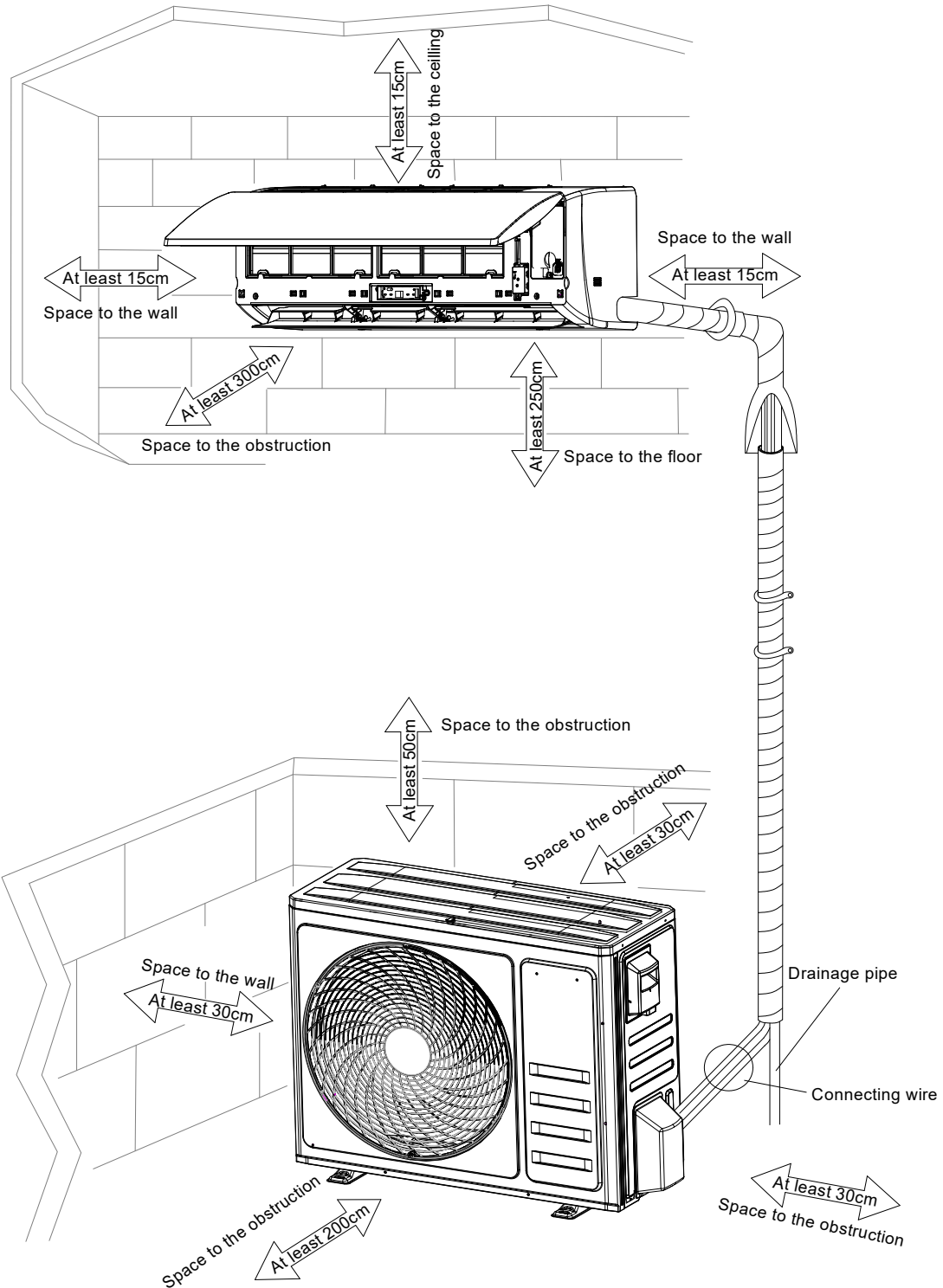

residual combustible refrigerant gas from any area nearby and surrounding the leak point and use a handheld detector for detection and not clear the alarm until the concentration of refrigerant is zero.

## 2 Installation



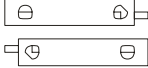

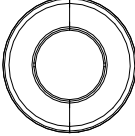

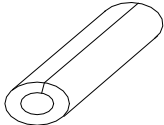









### 2.1 Installation Dimension Diagram



## 2.2 Accessory

<p>Remote controller</p> 	<p>Remote controller supporter</p> 	<p>Batteries</p> 	<p>Vinyl tape</p> 
<p>Drain hose</p> 	<p>Hole cover</p> 	<p>Screw</p> 	<p>Insulation material</p> 

## 2.3 Tools

Tool name	Picture	Tool name	Picture	Tool name	Picture
Standard Wrench		Pipe Cutter		Vacuum Pump	
Adjustable/ Crescent Wrench		Screw drivers (Phillips & Flat blade)		Safety Glasses	
Torque Wrench		Manifold and Gauges		Work Gloves	
Hex Keys or Allen Wrenches		Level		Refrigerant Scale	
Drill & Drill Bits		Flaring tool		Micron Gauge	
Hole Saw		Clamp on Amp Meter			

## 2.4 Position

### Indoor unit

- Install the indoor unit level on a strong wall that is not subject to vibrations
- The inlet and outlet ports should not be obstructed: the air should be able to blow all over the room.
- Do not install the unit near a source of heat, steam or flammable gas.
- Do not install the unit in too windy or dusty places.
- Do not install the unit where people often pass. Select a place where the air discharge and operating sound level will not disturb the neighbors.
- Install the unit where connection between indoor and outdoor unit is as easy as possible.
- Install the unit where it is easy to drain the condensed water.
- Check the machine operation regularly and leave the necessary spaces as shown in the picture.
- Install the indoor unit where the filter can be easily accessible.

### OUTDOOR UNIT

- Do not install the outdoor unit near sources of heat, steam or flammable gas.
- Do not install the unit in too windy or dusty places.
- Do not install the unit where people often pass. Select a place where the air discharge and operating sound level will not disturb the neighbors.
- Avoid installing the unit where it will be exposed to direct sunlight (other wise use a protection, if necessary, that should not interfere with the air flow).
- Leave the spaces as shown in the picture for
- The air to circulate freely.
- Install the outdoor unit in a safe and solid place.
- If the outdoor unit is subject to vibration, place rubber gaskets onto the feet of the unit.
- Install the indoor unit in the room to be air conditioning, avoiding to installation in corridors or communal areas.
- Install the indoor unit at a height of at least 2.5m from the ground.

Minimum space to be left (mm) showing in the picture.

## 2.5 Electricity and wiring

### Safety precaution

- 1) Must follow the electric safety regulations when installing the unit.
- 2) According to the local safety regulations, use qualified power supply circuit and air switch.
- 3) Make sure the power supply matches with the requirement of air conditioner. Unstable power supply or incorrect wiring may result in electric shock, fire hazard or malfunction. Please install proper power supply cables before using the air conditioner.

The power cord should be selected according to the following specifications sheet.

Appliance Amps(A)	Wire Size (mm <sup>2</sup> )
5	0.75
10	1.0
13	1.5
18	1.6
25	2.0
30	2.5

## 2.6 IDU Installation

### To install, proceed as follows:

#### 2.6.1 Installation of the mounting plate.

- 1) By using a level, put the mounting plate in a perfect square position vertically and horizontally.
- 2) Drill 32mm deep holes in the wall to fix the plate.
- 3) Insert the plastic anchors into the hole.
- 4) Fix the mounting plate by using the provided tapping screws.
- 5) Check that the mounting plate is correctly fixed.

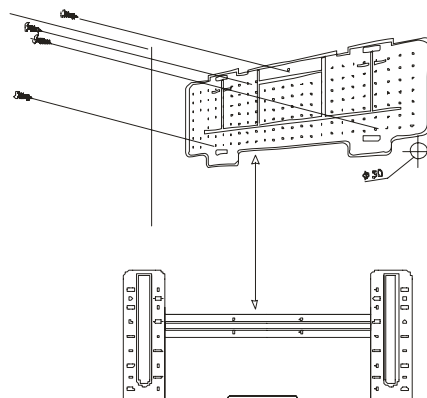

9K(770X)

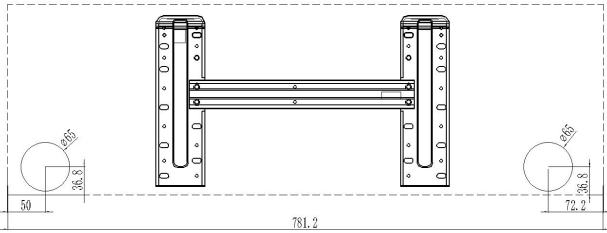

12K(770X)

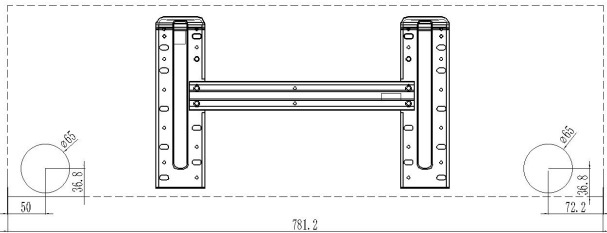

18K(900X)

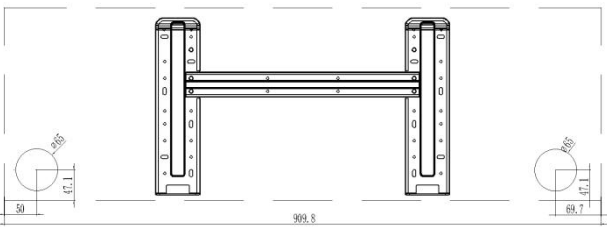

24K(1010X)

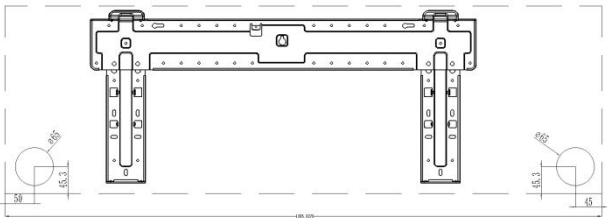

**Note:** The shape of the mounting plate may be different from the one above, but installation method is similar.

**2.6.2 Drilling a hole in the wall for the piping**

- 1) Decide where to drill the hole in the wall for the piping (if necessary) according to the position of the mounting plate
- 2) Install a flexible flange through the hole in the wall to keep the latter intact and clean.

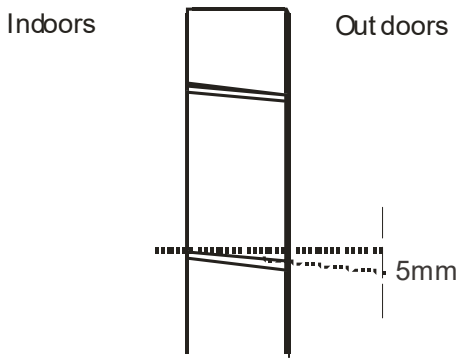

The hole must slope downwards towards the exterior.  
**Note:** Keep the drain pipe down towards the direction of the wall hole, otherwise leakage may occur.

**2.6.3 Electrical connections---Indoor unit**

- 1).Lift the front panel.
- 2).Take off the cover as indicated in the picture (by removing a screw or by breaking the hooks).
- 3).For the electrical connections, see the circuit diagram on the right part of the unit under the front panel.
- 4).Connect the cable wires to the screw terminals by following the numbering, Use wire size suitable to the electric power input (see name plate on the unit) and according to all current national safety code requirements.
- 5).The cable connecting the outdoor and indoor units must be suitable for outdoor use.
- 6).The plug must be accessible also after the appliance has been installed so that it can be pulled out if necessary.
- 7).An efficient earth connection must be ensured.
- 8).If the power cable is damaged, it must be replaced by an authorized Service Centre.

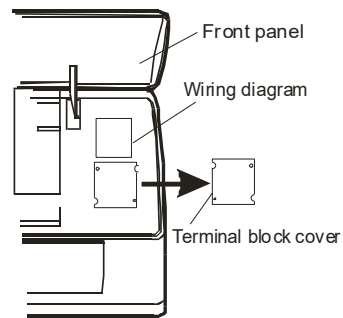

★ **Refrigerant piping connection**

The piping can be run in the 3 directions indicated by numbers in the picture. When the piping is run in direction 1 or 3, cut a notch along the groove on the side of the indoor unit with a cutter.

Run the piping in the direction of the wall hole and bind the copper pipes, the drain pipe and the power cables together with the tape with the drain pipe at the bottom, so that water can flow freely.

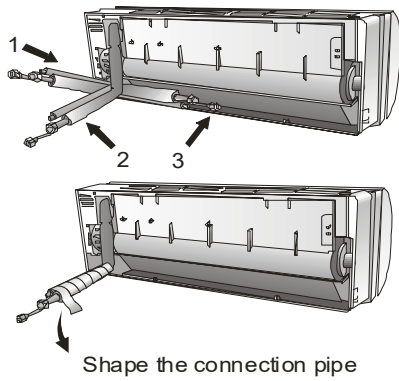

**2.6.4 Connecting the pipes.**

- Do not remove the cap from the pipe until connecting it, to avoid dampness or dirt from entering.
- If the pipe is bent or pulled too often, it will become stiff. Do not bend the pipe more than three times at one point.
- When extending the rolled pipe, straighten the pipe by unwinding it gently as shown in the picture.

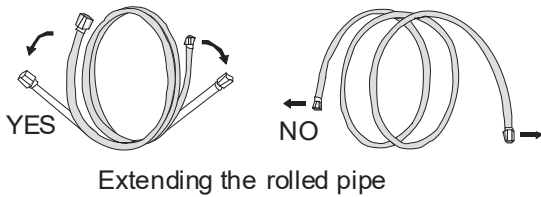

**2.6.5 Connections to the indoor unit**

- 1).Remove the indoor unit pipe cap (check that there is no debris inside).
- 2).Insert the flare nut and create a flange at the extreme end of the connection pipe.

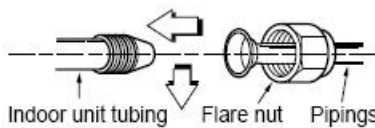

- 3).Tighten the connections by using two wrenches working in opposite directions.

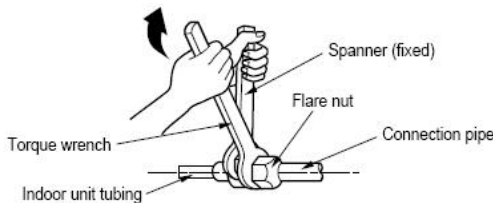

Capacity (Btu/h)	Pipe Size (Torque)	
	Gas	Liquid
7/9/12K	3/8" (4.2kg.m)	1/4" (1.8kg.m)
18K	1/2" (5.5kg.m)	1/4" (1.8kg.m)
24K	5/8" (6.6kg.m)	3/8" (4.2kg.m)

When extending the drain hose at the indoor unit, install the drain pipe.

**Wrap the insulation material around the connecting portion.**

- Overlap the connection pipe insulation material and the indoor unit pipe insulation material. Bind them together with vinyl tape so that there is no gap.

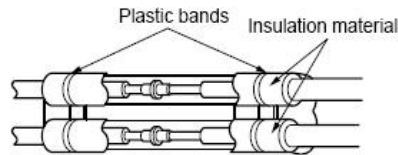

Wrap the area which accommodates the rear piping housing section with vinyl tape.

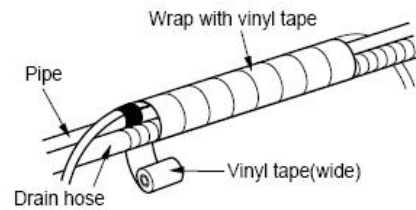

- Bundle the piping and drain hose together by wrapping them with vinyl tape over the range within which they fit into the rear piping housing section.

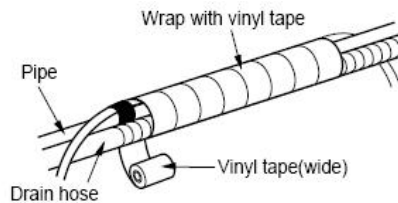

**2.6.6 Indoor unit condensed water drainage**

The indoor unit condensed water drainage is fundamental for the success of the installation.

- 1).Place the drain hose below the piping, taking care not to create siphons.
- 2).The drain hose must slant downwards to aid drainage.
- 3).Do not bend the drain hose or leave it protruding or twisted and do not put the end of it in water. If an extension is connected to the drain hose, ensure that it is lagged when it passes into the indoor unit.
- 4).If the piping is installed to the right, the pipes, power cable and drain hose must be lagged and



secured onto the rear of the unit with a pipe connection.

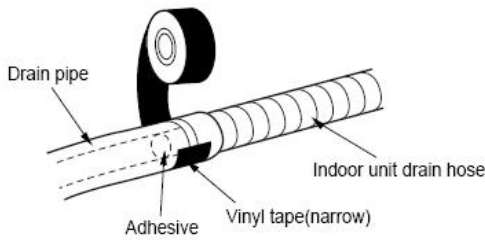

- Insert the pipe connection into the relative slot.
- Press to join the pipe connection to the base.

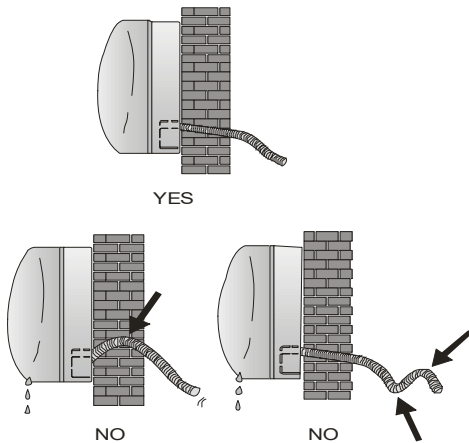

## 2.7 ODU Installation

- The outdoor unit should be installed on a solid wall and fastened securely.
- The following procedure must be observed before connecting the pipes and connecting cables : decide which is the best position on the wall and leave enough space to be able to carry out maintenance easily.
- Fasten the support to the wall using screw anchors which are particularly suited to the type of wall;
- Use a larger quantity of screw anchors than normally required for the weight they have to bear to avoid vibration during operation and remain fastened in the same position for years without the screws becoming loose.
- The unit must be installed following the national regulations.

### Outdoor unit condensed water drainage (only for heat pump models)

The condensed water and the ice formed in the outdoor unit during heating operation can be drained away

through the drain pipe.

- 1) Fasten the drain port in the 25mm hole placed in the part of the unit as shown in the picture.
- 2) Connect the drain port and the drain pipe. Pay attention that water is drained in a suitable place.

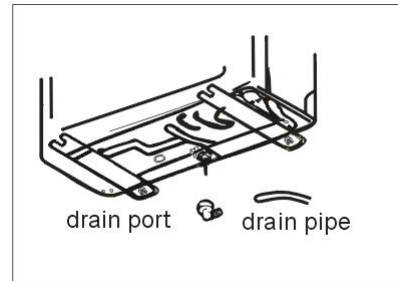

### Electronic connections

1. Take the cover away.
2. Connect the cable wires to the terminal board using the same numbering as in the indoor unit.
3. For the electrical connections, see the wiring diagram on the back of the cover
4. Fasten the cables with a cable-clamp.
5. An efficient earth connection must be ensured.
6. Replace the covers.

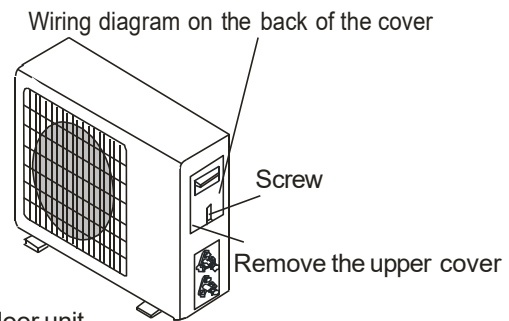

### Connecting the pipe

Screw the flare nuts to the outdoor unit coupling with the same tightening procedures described for the indoor unit.

Note: If the tightening torque is not sufficient, there will probably be some leakage. With excessive tightening torque there will also be some leakage, as the flange could be damaged.

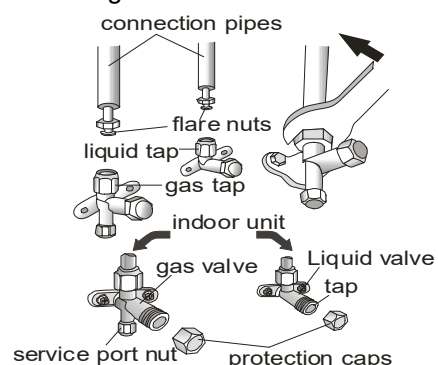

## 2.8 Vacuum and gas leakage test

### 1. Use vacuum Pump

- 1) Air and humidity left inside the refrigerant circuit can cause compressor malfunction. After having connected the indoor and outdoor units, bleed the air and humidity from the refrigerant circuit by using a vacuum pump.
- 2) Open the piezometer and operation for 10-15minutes to check if the pressure of piezometer remains in -0.1Mpa.
- 3) Close the vacuum pump and maintain this status for 1-2min to check if the pressure of piezometer remains in -0.1Mpa. If the pressure decrease, there may be leakage.
- 4) Remove the piezometer, open the valve core of liquid valve and gas valve completely.
- 5) Tighten the screw caps of valve and refrigerant charging vent.

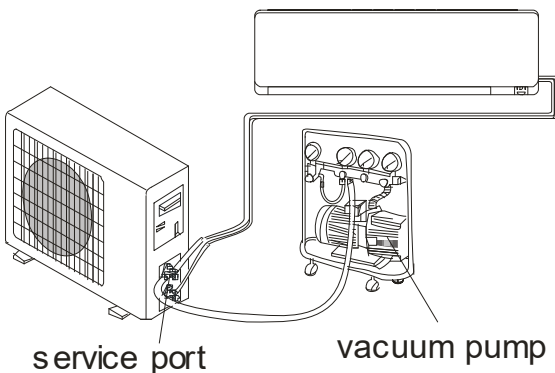

### 2. Leakage Detection

- 1).With leakage detection.  
Check if there is leakage with leakage detection.
- 2).With soap water. If leakage detection is not available, please use soap water for leakage detection. Apply soap water at the suspected position and keep the soap water for more than 3min. If there are air bubbles coming out of this position, there a leakage.

## 2.9 Final test

### 1 Preparation of test operation.

- The client approves the air conditioner installation.
- Specify the important notes for air conditioner to the client.

### 2 Method of test operation

- Put through the power, press ON/OFF button on the remote controller to start operation.
- Press MODE button the select AUTO, COOL, DRY, FAN and HEAT to check whether the operation is normal or not.  
If ambient temperature is lower than 16°C, the air conditioner can't start cooling.





7999NW 81 Place - Medley, FL 33166

Tel: (305) 593 - 8358

[www.klimaïre.com](http://www.klimaïre.com)

[customerservice@klimaïre.com](mailto:customerservice@klimaïre.com)

The Klimaïre logo is a registered Trademark of Klimaïre  
Products Inc. Copyright 2024 Klimaïre Products Inc.

The design and specifications are subject to change without prior notice for  
product improvement. Consult with the sales agency or manufacturer for details.