

KDIC

REMOTE CONTROLLER

OWNER'S MANUAL

Model: RG10F8(M2)/BGEFU1

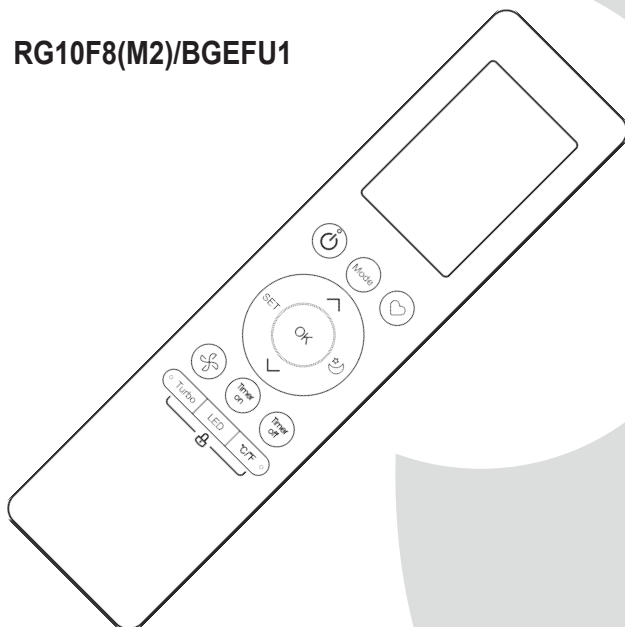

KLIMAIRE[®] ≈

IMPORTANT NOTE:

Thank you for purchasing our air conditioner.

Please read this manual carefully before operating your new air conditioning unit.

Make sure to save this manual for future reference.

Table of Contents

Remote Controller Specifications	02
Handling the Remote Controller	03
Buttons and Functions	04
Remote Screen Indicators	06
How to Use Basic Functions	07
How to Use Advanced Functions	10

Remote Controller Specifications

Model	RG10F8 (M2) /BGEFU1, RG10F8(M2)/BGFFU1
Rated Voltage	3.0V (Dry batteries R03/LR03×2)
Signal Receiving Range	8m
Environment	-5°C~60°C (23°F~140°F)

Quick Start Guide

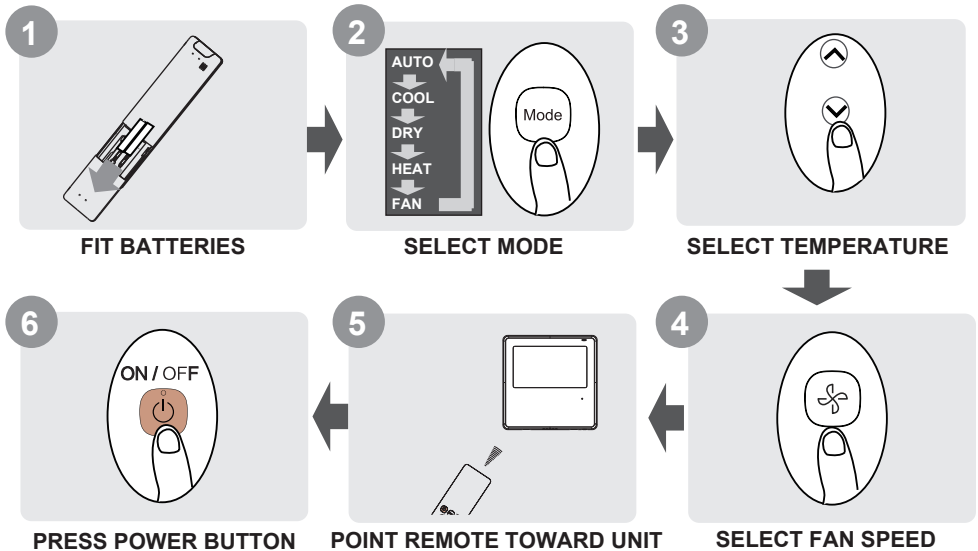

NOT SURE WHAT A FUNCTION DOES?

Refer to the **How to Use Basic Functions** and **How to Use Advanced Functions** sections of this manual for a detailed description of how to use your air conditioner.

SPECIAL NOTE

- Button designs on your unit may differ slightly from the example shown.
- If the indoor unit does not have a particular function, pressing that function's button on the remote control will have no effect.
- When there are wide differences between "Remote controller Manual" and "USER'S MANUAL" on function description, the description of "USER'S MANUAL" shall prevail.

Handling the Remote Controller

Inserting and Replacing Batteries

Your air conditioning unit may come with two batteries (some units). Put the batteries in the remote control before use.

1. Slide the back cover from the remote control downward, exposing the battery compartment.
2. Insert the batteries, paying attention to match up the (+) and (-) ends of the batteries with the symbols inside the battery compartment.
3. Slide the battery cover back into place.

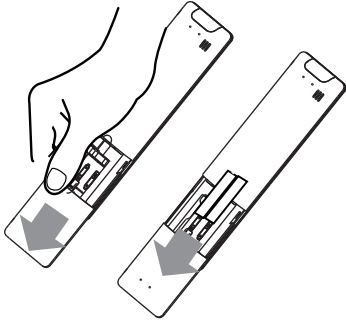

Battery Performance

For optimal product performance:

- Do not mix old and new batteries, or batteries of different brands.
- Do not leave batteries in the remote control if you don't plan on using the device for more than 2 months.

Notes For Using Remote Control

The device could comply with the local national regulations.

- In Canada, it should comply with CAN ICES-3 (B)/NMB-3 (B).
- In USA, this device complies with part 15 of the FCC Rules. Operation is subject to the following two conditions:
 - (1) This device may not cause harmful interference, and
 - (2) this device must accept any interference received, including interference that may cause undesired operation.

This equipment has been tested and found to comply with the limits for a Class B digital device, pursuant to part 15 of the FCC Rules. These limits are designed to provide reasonable protection against harmful interference in a residential installation. This equipment generates, uses and can radiate radio frequency energy and, if not installed and used in accordance with the instructions, may cause harmful interference to radio communications. However, there is no guarantee that interference will not occur in a particular installation. If this equipment does cause harmful interference to radio or television reception, which can be determined by turning the equipment off and on, the user is encouraged to try to correct the interference by one or more of the following measures:

- Reorient or relocate the receiving antenna.
- Increase the separation between the equipment and receiver.
- Connect the equipment into an outlet on a circuit different from that to which the receiver is connected.
- Consult the dealer or an experienced radio/TV technician for help.
- Changes or modifications not approved by the party responsible for compliance could void user's authority to operate the equipment.

Remote Control

- Direct sunlight can interfere with the infrared signal receiver.
- There must be a clear line of sight between the remote and the appliance.
- If the signals from the remote control happen to control another appliance, move the appliance to another location or contact customer service.

! Battery Disposal

- Do not dispose of batteries as unsorted municipal waste. Refer to local laws for proper disposal of batteries.
- Batteries may have a chemical symbol at the bottom of the disposal icon. This chemical symbol means that the battery contains a heavy metal that exceeds a certain concentration. An example is Pb: Lead (>0.004%).
- Appliances and used batteries must be treated in a specialized facility for reuse, recycling and recovery. By ensuring correct disposal, you will help avoid possible negative consequences for the environment and human health.



Buttons and Functions

Before you begin using your new air conditioner, make sure to familiarize yourself with its remote control. The following is a brief introduction to the remote control itself. For instructions on how to operate your air conditioner, refer to the **How to Use Basic Functions** section of this manual.

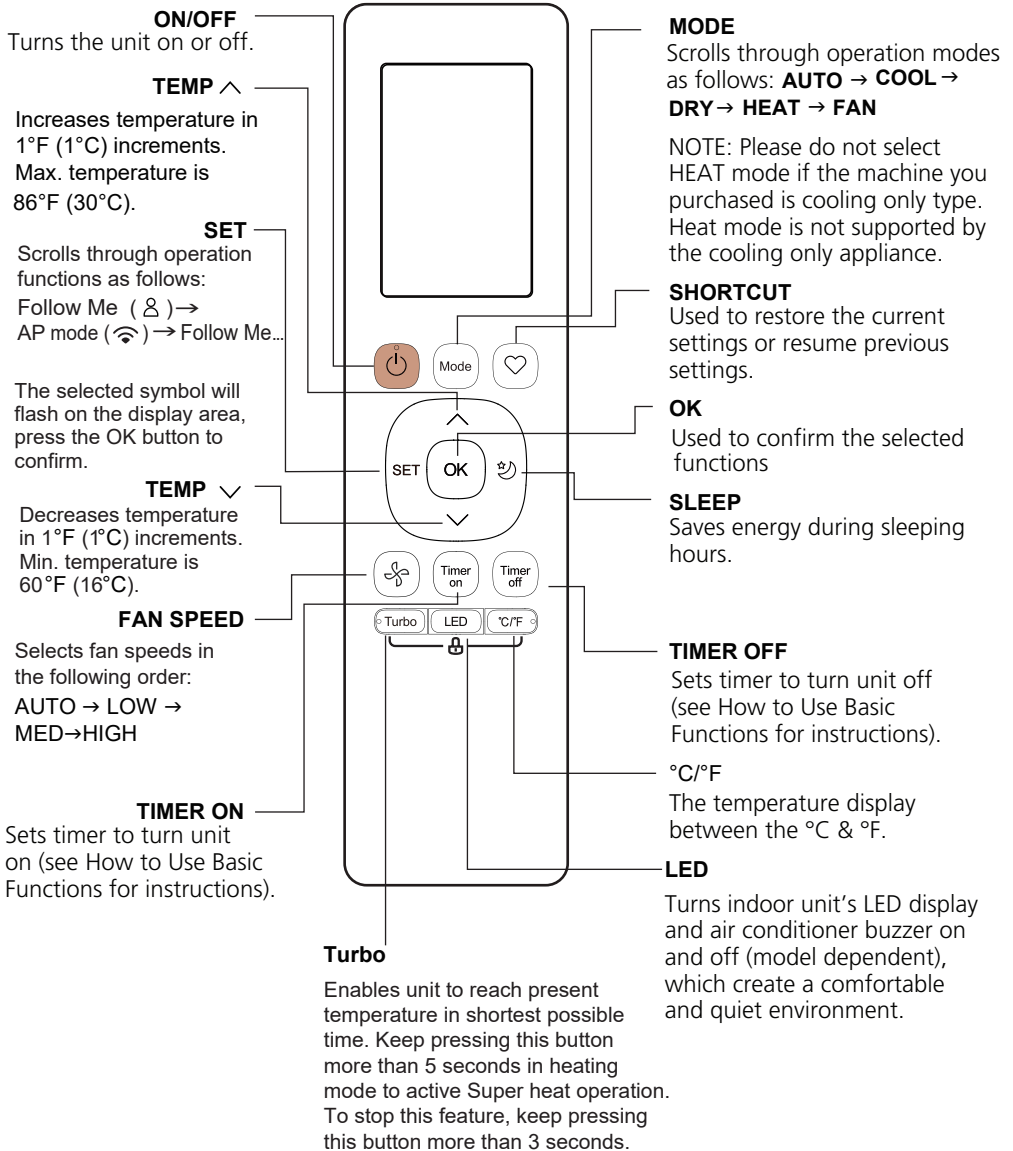

Model: RG10F8 (M2) /BGEFU1

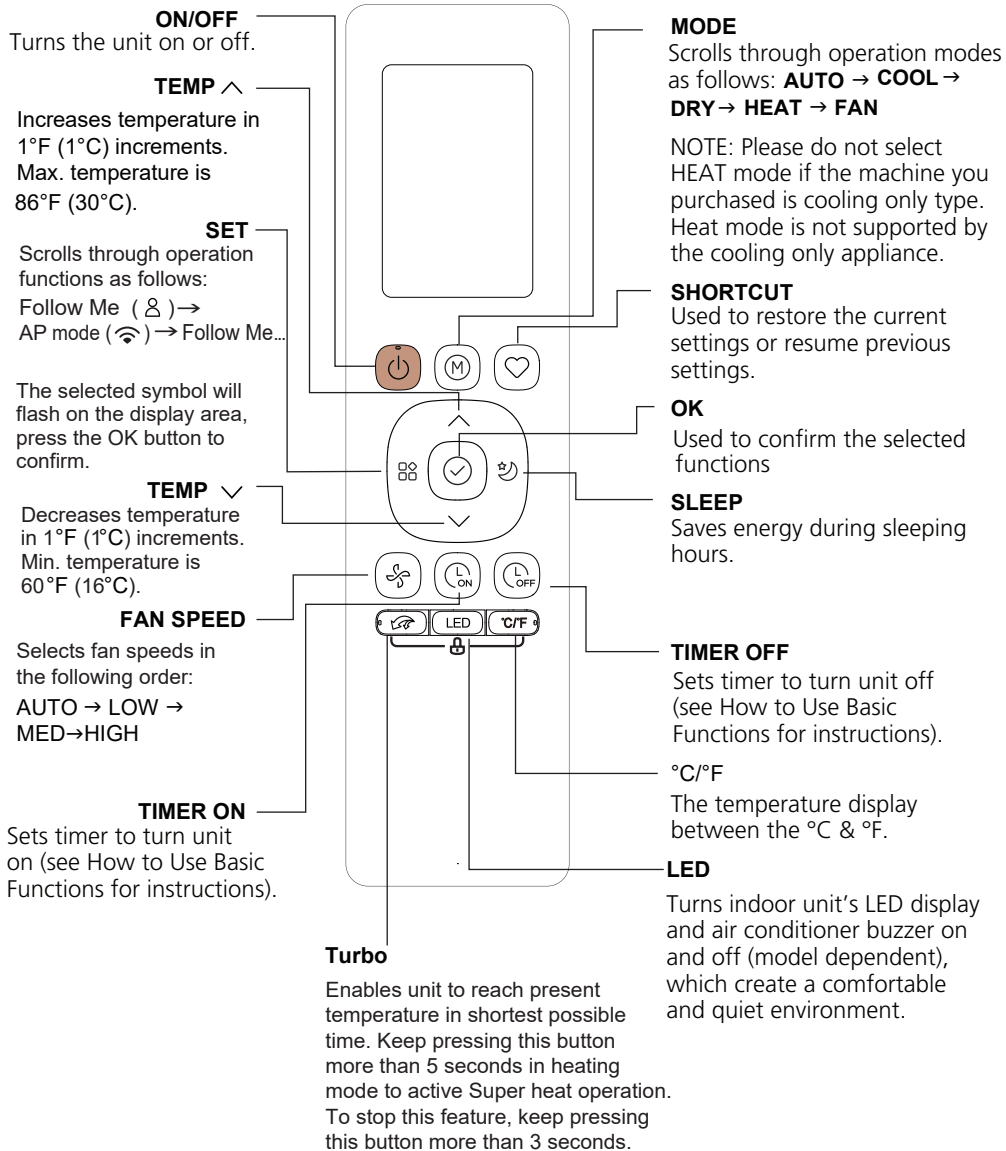

Model: RG10F8(M2)/BGFFU1

Remote Screen Indicators

Information is displayed when the remote controller is power up.

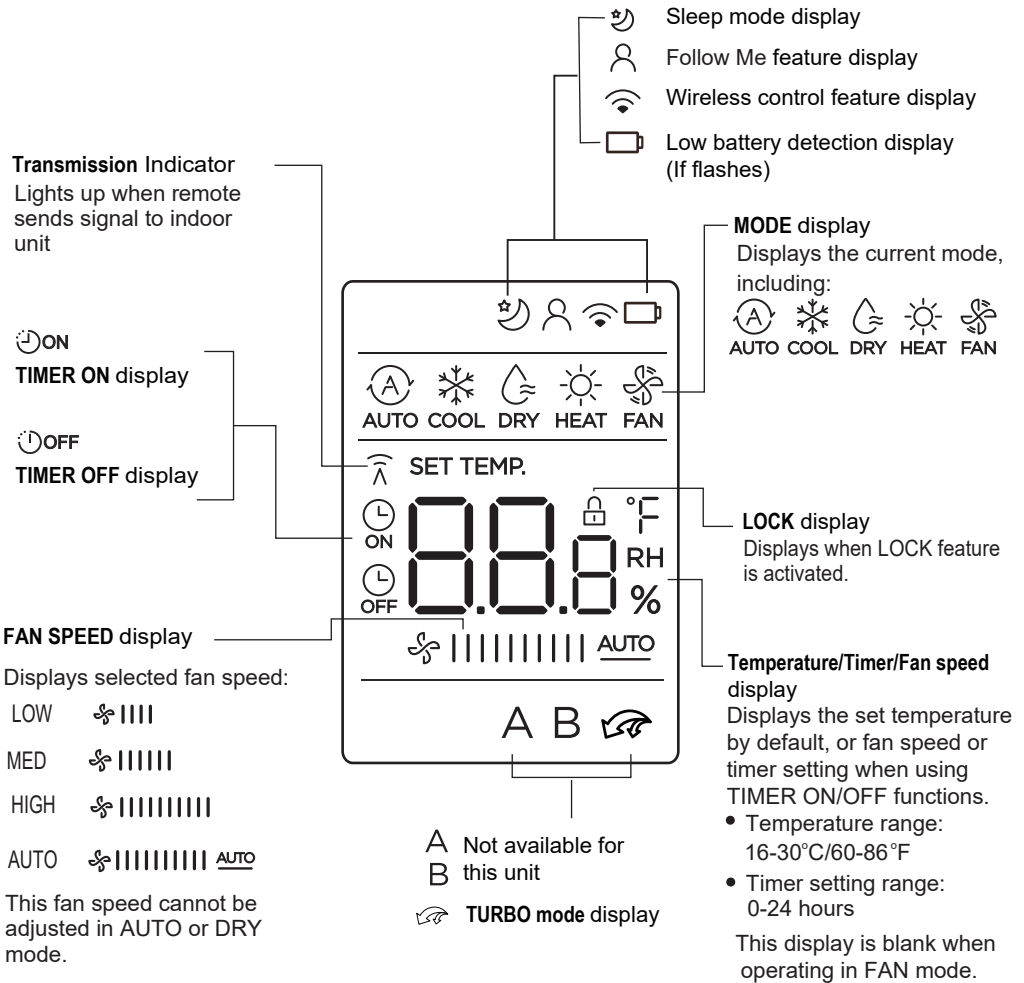

Note:

All indicators shown in the figure are for the purpose of clear presentation. But during the actual operation, only the relative function signs are shown on the display window.

How to Use Basic Functions

Basic operation

ATTENTION! Before operation, please ensure the unit is plugged in and power is available.

SETTING TEMPERATURE

The operating temperature range for units is 60-86°F (16-30°C).

You can increase or decrease the set temperature in 1°F (1°C) increments.

AUTO Mode

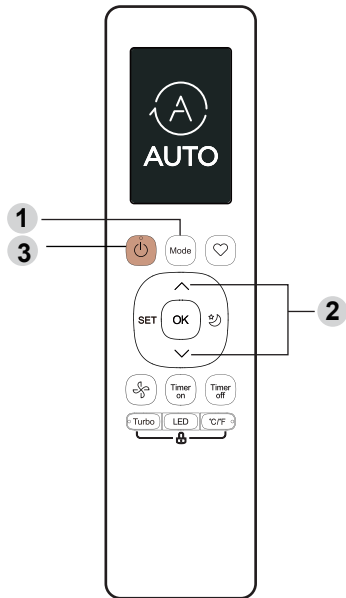

In AUTO mode, the unit will automatically select the COOL, FAN, or HEAT function based on the set temperature.

1. Press the **MODE** button to select **AUTO**.
2. Set your desired temperature using the **TEMP** ^ or **TEMP** v button.
3. Press the **ON/OFF** button to start the unit.

NOTE: FAN SPEED can't be set in AUTO mode.

COOL Mode

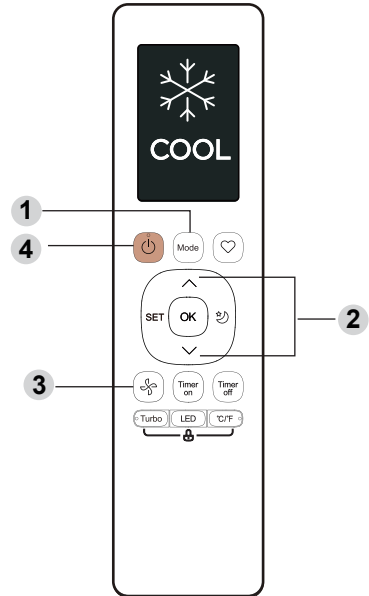

1. Press the **MODE** button to select **COOL** mode.
2. Set your desired temperature using the **TEMP** ^ or **TEMP** v button.
3. Press **FAN** button to select the fan speed: AUTO, LOW, MED, HIGH .
4. Press the **ON/OFF** button to start the unit.

DRY Mode (dehumidifying)

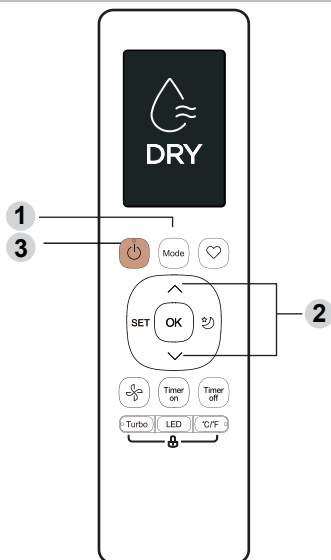

1. Press the **MODE** button to select **DRY**.
2. Set your desired temperature using the **TEMP** \wedge or **TEMP** \vee button.
3. Press the **ON/OFF** button to start the unit.

NOTE: FAN SPEED cannot be changed in DRY mode.

HEAT Mode

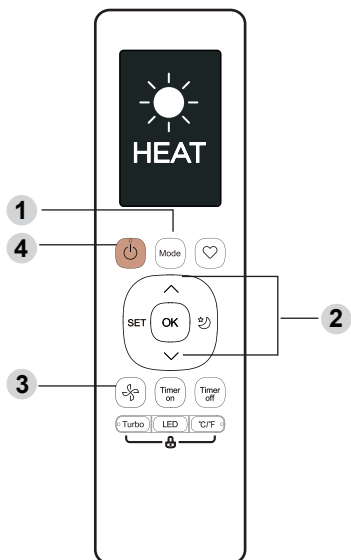

1. Press the **MODE** button to select **HEAT** mode.
2. Set your desired temperature using the **TEMP** \wedge or **TEMP** \vee button.
3. Press **FAN** button to select the fan speed: AUTO, LOW, MED, HIGH.
4. Press the **ON/OFF** button to start the unit.

NOTE: As outdoor temperature drops, the performance of your unit's HEAT function may be affected. In such instances, we recommend using this air conditioner in conjunction with other heating appliances.

FAN Mode

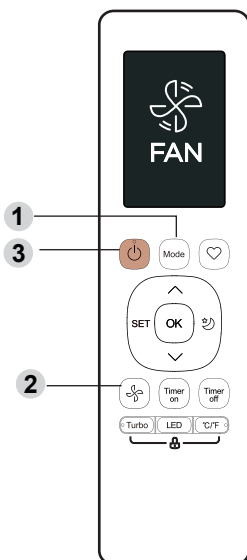

1. Press the **MODE** button to select **FAN** mode.
2. Press **FAN** button to select the fan speed: AUTO, LOW, MED, HIGH .
3. Press the **ON/OFF** button to start the unit.

NOTE: You can't set temperature in FAN mode. As a result, your remote control's LCD screen will not display temperature.

Setting the TIMER

TIMER ON/OFF - Set the amount of time after which the unit will automatically turn on/off.

TIMER ON setting

Press TIMER ON button to initiate the ON time sequence.



Press up or down button for multiple times to set the desired time to turn on the unit.



Point remote to unit and wait 1sec, the TIMER ON will be activated.



TIMER OFF setting

Press TIMER OFF button to initiate the OFF time sequence.



Press Temp. up or down button for multiple times to set the desired time to turn off the unit.

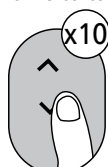

Point remote to unit and wait 1sec, the TIMER OFF will be activated.



NOTE:

1. When setting the TIMER ON or TIMER OFF, the time will increase by 30 minutes increments with each press, up to 10 hours. After 10 hours and up to 24, it will increase in 1-hour increments. (For example, press 5 times to get 2.5h, and press 10 times to get 5h.) The timer will revert to 0.0 after 24.
2. Cancel either function by setting its timer to 0.0h.

TIMER ON & OFF setting (example)

Keep in mind that the time periods you set for both functions refer to hours after the current time.

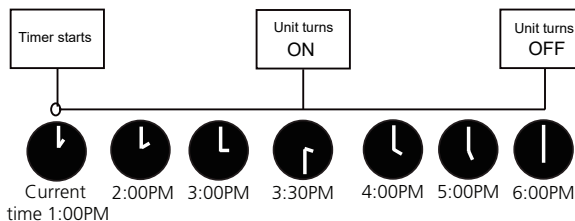
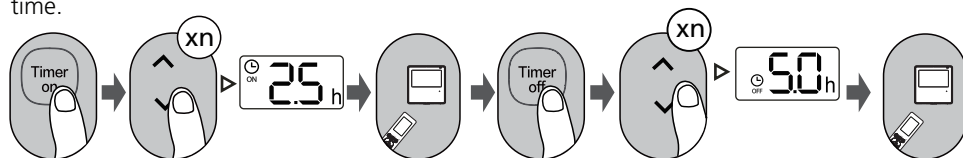

Example: If current timer is 1:00PM, to set the timer as above steps, the unit will turn on 2.5h later (3:30PM) and turn off at 6:00PM.

How to Use Advanced Functions

SHORTCUT function

Press SHORTCUT button



Push this button when remote controller is on, the system will automatically revert back to the previous settings including operating mode, setting temperature, fan speed level and sleep feature (if activated).

If pushing more than 2 seconds, the system will automatically restore the current operation settings including operating mode, setting temperature, fan speed level and sleep feature (if activated).

°C/°F

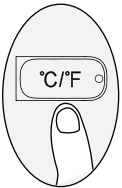

Press this button will alternate the temperature display between the °C & °F.

TURBO Function

Press TURBO button



When you select Turbo feature in COOL mode, the unit will blow cool air with strongest wind setting to jump-start the cooling process.

When you select Turbo feature in HEAT mode, the unit will blow heat air with strongest wind setting to jump-start the heating process.



Super heat function

Long press Boost button for 5 seconds in Heating/Auto heating mode to initiate super heat function. To stop this feature, long press this button for 3 seconds. This function is mainly used to improve the heating speed of the unit at low temperature. Under super heat mode, the louver will open to its maximum angle to enable unit to reach preset temperature in shortest possible time. Note: The anti-cold air feature is disable 5 minutes later after the compressor starts, it may result in low air outlet temperature. You should choose whether to enable this function according to your need.

NOTE:

- If the Super heat function is activated, “On” displays for 3 seconds on the indoor unit display window.
- If the Super heat function is stopped, “OF” displays for 3 seconds on the indoor unit display window.
- Change the mode or turn the unit off to stop the super heating operation.

LED DISPLAY

Press LED button



Press this button to turn on and turn off the display on the indoor unit.

SLEEP Function

Press SLEEP button



The SLEEP function is used to decrease energy while you sleep (and don't need the same temperature settings to stay comfortable). This function can only be activated via remote control.

For the details, please see "sleep operation" in "USER'S MANUAL".

Note: The SLEEP function is not available in FAN or DRY mode.

LOCK function

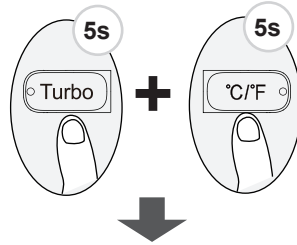

Press together **Turbo** button and **°C/°F** button at the same time more than 5 seconds to activate Lock function.

All buttons will not response except pressing these two buttons for two seconds again to disable locking.

SET function

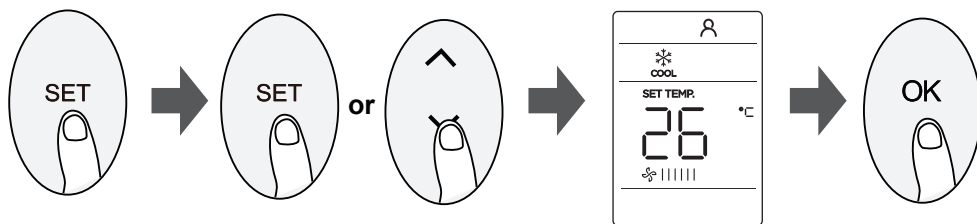

- Press the SET button to enter the function setting, then press SET button or TEMP▼ or TEMP▲ button to select the desired function. The selected symbol will flash on the display area, press the OK button to confirm.
- To cancel the selected function, just perform the same procedures as above.
- Press the SET button to scroll through operation functions as follows:
Follow Me (⊗) → AP mode*(📶)
[*]: Only for the unit has AP function.

Follow Me function (⊗):

The Follow Me function enables the remote control to measure the temperature at its current location and send this signal to the air conditioner every 3 minutes interval. When using AUTO, COOL or HEAT modes, measuring ambient temperature from the remote control (instead of from the indoor unit itself) will enable the air conditioner to optimize the temperature around you and ensure maximum comfort.

NOTE:

Press the SET button to select Follow Me function, then press OK button to confirm. Pressing the OK button for 3 seconds will start/stop memory feature of Follow Me function.

- If the memory feature is activated, “On” displays for 3 seconds on the screen.
- If the memory feature is stopped, “OF” displays for 3 seconds on the screen.
- While the memory feature is activated, press the ON/OFF button, shift the mode or power failure will not cancel the Follow me function.

AP function (📶):

Choose AP mode to do wireless network configuration. To enter the AP mode, continuously press the LED button seven times in 10 seconds.

KLIMAIRE[®] ≈

Klimaïre Products Inc.
7999 NW 81 Place - Medley, FL 33195 USA
Tel: (305) 594 - 4972 | Fax: (305) 675-2212
www.klimaïre.com | sales@klimaïre.com

The Klimaïre logo is a registered trademark
of Klimaïre Products, Inc. Copyright 2026

The design and specifications are subject to change without prior notice for product improvement. Consult with the sales agency or manufacturer for details.

M3UM2601