

# Service and Troubleshooting

## A/GPGM3 13.4 SEER2 & A/GPGM5 15.2 Gas-Electric Package Units with R-410A Refrigerant

Pride and workmanship go into every product to provide our customers with quality products. It is possible, however, that during its lifetime a product may require service. Products should be serviced only by a qualified service technician who is familiar with the safety procedures required in the repair and who is equipped with the proper tools, parts, testing instruments and the appropriate service manual. **REVIEW ALL SERVICE INFORMATION IN THE APPROPRIATE SERVICE MANUAL BEFORE BEGINNING REPAIRS.**

### TABLE OF CONTENTS

IMPORTANT INFORMATION .....	2
PRODUCT IDENTIFICATION .....	4
SYSTEM OPERATION .....	6
SCHEDULED MAINTENANCE .....	12
SERVICING .....	14
CHECKING VOLTAGE .....	14
CHECKING WIRING .....	14
CHECKING THERMOSTAT AND WIRING .....	14
CHECKING TRANSFORMER AND CONTROL CIRCUIT .....	15
CHECKING CONTACTOR AND/OR RELAYS .....	15
CHECKING CONTACTOR CONTACTS .....	16
CHECKING FAN RELAY CONTACTS .....	16
CHECKING HIGH PRESSURE CONTROL .....	16
CHECKING LOW PRESSURE CONTROL .....	17
CHECKING CAPACITOR .....	17
TESTING START RELAY KITS .....	17
CAPACITANCE CHECK (MFD) .....	18
CHECKING FAN AND BLOWER MOTOR WINDINGS (PSC MOTORS) .....	18
CHECKING ECM MOTOR WINDINGS .....	18
CHECKING EEM MOTORS .....	19
CHECKING ECM MOTORS .....	19
CHECKING ECM MOTOR WINDINGS .....	20
CHECKING COMPRESSOR .....	20
RESISTANCE TEST .....	21
GROUND TEST .....	21
UNLOADER TEST PROCEDURE .....	22
OPERATION TEST .....	22
LOCKED ROTOR TEST .....	23
TESTING CRANKCASE HEATER (OPTIONAL ITEM) .....	23
REFRIGERATION REPAIR PRACTICE .....	23



### WARNING

ONLY PERSONNEL THAT HAVE BEEN TRAINED TO INSTALL, ADJUST, SERVICE, MAINTENANCE OR REPAIR (HEREINAFTER, "SERVICE") THE EQUIPMENT SPECIFIED IN THIS MANUAL SHOULD SERVICE THE EQUIPMENT.

THIS EQUIPMENT IS NOT INTENDED FOR USE BY PERSONS (INCLUDING CHILDREN) WITH REDUCED PHYSICAL, SENSORY OR MENTAL CAPABILITIES, OR LACK OF EXPERIENCE AND KNOWLEDGE, UNLESS THEY HAVE BEEN GIVEN SUPERVISION OR INSTRUCTION CONCERNING USE OF THE APPLIANCE BY A PERSON RESPONSIBLE FOR THEIR SAFETY.

CHILDREN SHOULD BE SUPERVISED TO ENSURE THAT THEY DO NOT PLAY WITH THE EQUIPMENT.

THE MANUFACTURER WILL NOT BE RESPONSIBLE FOR ANY INJURY OR PROPERTY DAMAGE ARISING FROM IMPROPER SUPERVISION, SERVICE OR SERVICE PROCEDURES. IF YOU SERVICE THIS UNIT, YOU ASSUME RESPONSIBILITY FOR ANY INJURY OR PROPERTY DAMAGE WHICH MAY RESULT. IN ADDITION, IN JURISDICTIONS THAT REQUIRE ONE OR MORE LICENSES TO SERVICE THE EQUIPMENT SPECIFIED IN THIS MANUAL, ONLY LICENSED PERSONNEL SHOULD SERVICE THE EQUIPMENT. IMPROPER SUPERVISION, INSTALLATION, ADJUSTMENT, SERVICING, MAINTENANCE OR REPAIR OF THE EQUIPMENT SPECIFIED IN THIS MANUAL, OR ATTEMPTING TO INSTALL, ADJUST, SERVICE OR REPAIR THE EQUIPMENT SPECIFIED IN THIS MANUAL WITHOUT PROPER SUPERVISION OR TRAINING MAY RESULT IN PRODUCT DAMAGE, PROPERTY DAMAGE, PERSONAL INJURY OR DEATH.



### WARNING

DO NOT BYPASS SAFETY DEVICES.

RS6300012r9  
March 2023

# IMPORTANT INFORMATION

STANDING PRESSURE TEST (RECOMMENDED BEFORE SYSTEM EVACUATION)..... 23

LEAK TESTING (NITROGEN OR NITROGEN-TRACED)..... 24

SYSTEM EVACUATION..... 24

DEEP VACUUM METHOD (RECOMMENDED) ..... 24

TRIPLE EVACUATION METHOD (ALTERNATE)..... 25

CHARGING ..... 25

CHECKING COMPRESSOR EFFICIENCY ..... 25

REFRIGERANT CHARGE CHECK ..... 25

(UNITS WITH FIXED ORIFICE DEVICES) ..... 25

SUPERHEAT ..... 26

(UNITS WITH TXV DEVICE)..... 26

SUBCOOLING..... 26

THERMOSTATIC EXPANSION VALVE ..... 27

OVERFEEDING ..... 27

UNDERFEEDING..... 27

CHECKING EXPANSION VALVE OPERATION..... 30

FIXED ORIFICE RESTRICTOR DEVICES ..... 30

CHECKING RESTRICTED LIQUID LINE..... 30

OVERCHARGE OF REFRIGERANT ..... 30

NON-CONDENSABLES..... 31

COMPRESSOR BURNOUT..... 31

CHECKING EXTERNAL STATIC PRESSURE..... 31

AIRFLOW ADJUSTMENTS ..... 32

CHECKING TEMPERATURE RISE ..... 33

TESTING PRIMARY LIMIT CONTROL ..... 33

TESTING AUXILIARY LIMIT ..... 34

CHECKING FLAME ROLLOUT SWITCH ..... 34

TESTING INDUCER MOTOR ..... 35

TESTING GAS VALVE ..... 36

CHECKING MAIN BURNERS..... 36

CHECKING ORIFICES..... 36

CHECKING GAS PRESSURE ..... 37

CHECKING FOR DELAYED IGNITION ..... 38

CHECKING FOR FLASHBACK..... 38

CHECKING PRESSURE CONTROL ..... 38

HIGH ALTITUDE APPLICATION ..... 39

TESTING IGNITION CONTROL MODULE ..... 39

CHECKING FLAME SENSOR ..... 42

BLOWER PERFORMANCE DATA..... 43

TROUBLESHOOTING ..... 51

MAINTENANCE ..... 56

WIRING DIAGRAMS ..... 76

# IMPORTANT NOTICES RECOGNIZE SAFETY SYMBOLS, WORDS AND LABELS

 **WARNING**

**TO PREVENT THE RISK OF PROPERTY DAMAGE, PERSONAL INJURY, OR DEATH, DO NOT STORE COMBUSTIBLE MATERIALS OR USE GASOLINE OR OTHER FLAMMABLE LIQUIDS OR VAPORS IN THE VICINITY OF THIS APPLIANCE.**

 **WARNING**

**HIGH VOLTAGE**  
DISCONNECT ALL POWER BEFORE SERVICING OR INSTALLING THIS UNIT. MULTIPLE POWER SOURCES MAY BE PRESENT. FAILURE TO DO SO MAY CAUSE PROPERTY DAMAGE, PERSONAL INJURY OR DEATH.



 **WARNING**

**THIS UNIT SHOULD NOT BE CONNECTED TO, OR USED IN CONJUNCTION WITH, ANY DEVICES THAT ARE NOT DESIGN CERTIFIED FOR USE WITH THIS UNIT OR HAVE NOT BEEN TESTED AND APPROVED BY THE MANUFACTURER. SERIOUS PROPERTY DAMAGE OR PERSONAL INJURY, REDUCED UNIT PERFORMANCE AND/OR HAZARDOUS CONDITIONS MAY RESULT FROM THE USE OF DEVICES THAT HAVE NOT BEEN APPROVED OR CERTIFIED BY THE MANUFACTURER.**

OUTSIDE THE U.S., call 1-713-861-2500.

(Not a technical assistance line for dealers.) Your telephone company will bill you for the call.

# IMPORTANT INFORMATION

## SAFE REFRIGERANT HANDLING

While these items will not cover every conceivable situation, they should serve as a useful guide.



### WARNING

REFRIGERANTS ARE HEAVIER THAN AIR. THEY CAN "PUSH OUT" THE OXYGEN IN YOUR LUNGS OR IN ANY ENCLOSED SPACE. TO AVOID POSSIBLE DIFFICULTY IN BREATHING OR DEATH:

- NEVER PURGE REFRIGERANT INTO AN ENCLOSED ROOM OR SPACE. BY LAW, ALL REFRIGERANT MUST BE RECLAIMED.
- IF AN INDOOR LEAK IS SUSPECTED, THOROUGHLY VENTILATE THE AREA BEFORE BEGINNING WORK.
- LIQUID REFRIGERANT CAN BE VERY COLD. TO AVOID POSSIBLE FROSTBITE OR BLINDNESS, AVOID CONTACT WITH REFRIGERANT AND WEAR GLOVES AND GOGGLES. IF LIQUID REFRIGERANT DOES CONTACT YOUR SKIN OR EYES, SEEK MEDICAL HELP IMMEDIATELY.
- ALWAYS FOLLOW EPA REGULATIONS. NEVER BURN REFRIGERANT, AS POISONOUS GAS WILL BE PRODUCED.



### WARNING

TO AVOID POSSIBLE INJURY, EXPLOSION OR DEATH, PRACTICE SAFE HANDLING OF REFRIGERANTS.



### WARNING

THE COMPRESSOR POE OIL FOR R-410A UNITS IS EXTREMELY SUSCEPTIBLE TO MOISTURE ABSORPTION AND COULD CAUSE COMPRESSOR FAILURE. DO NOT LEAVE SYSTEM OPEN TO ATMOSPHERE ANY LONGER THAN NECESSARY FOR INSTALLATION.



### WARNING

TO AVOID POSSIBLE EXPLOSION:

- NEVER APPLY FLAME OR STEAM TO A REFRIGERANT CYLINDER. IF YOU MUST HEAT A CYLINDER FOR FASTER CHARGING, PARTIALLY IMMERSE IT IN WARM WATER.
- NEVER FILL A CYLINDER MORE THAN 80% FULL OF LIQUID REFRIGERANT.
- NEVER ADD ANYTHING OTHER THAN R-22 TO AN R-22 CYLINDER OR R-410A TO AN R-410A CYLINDER. THE SERVICE EQUIPMENT USED MUST BE LISTED OR CERTIFIED FOR THE TYPE OF REFRIGERANT USED.
- STORE CYLINDERS IN A COOL, DRY PLACE. NEVER USE A CYLINDER AS A PLATFORM OR A ROLLER.



### WARNING

TO AVOID POSSIBLE EXPLOSION, USE ONLY RETURNABLE (NOT DISPOSABLE) SERVICE CYLINDERS WHEN REMOVING REFRIGERANT FROM A SYSTEM.

- ENSURE THE CYLINDER IS FREE OF DAMAGE WHICH COULD LEAD TO A LEAK OR EXPLOSION.
  - ENSURE THE HYDROSTATIC TEST DATE DOES NOT EXCEED 5 YEARS.
  - ENSURE THE PRESSURE RATING MEETS OR EXCEEDS 400 LBS.
- WHEN IN DOUBT, DO NOT USE CYLINDER.

# PRODUCT IDENTIFICATION

# NOMENCLATURE

The model number is used for positive identification of component parts used in manufacturing. Please use this number when requesting service or parts information.

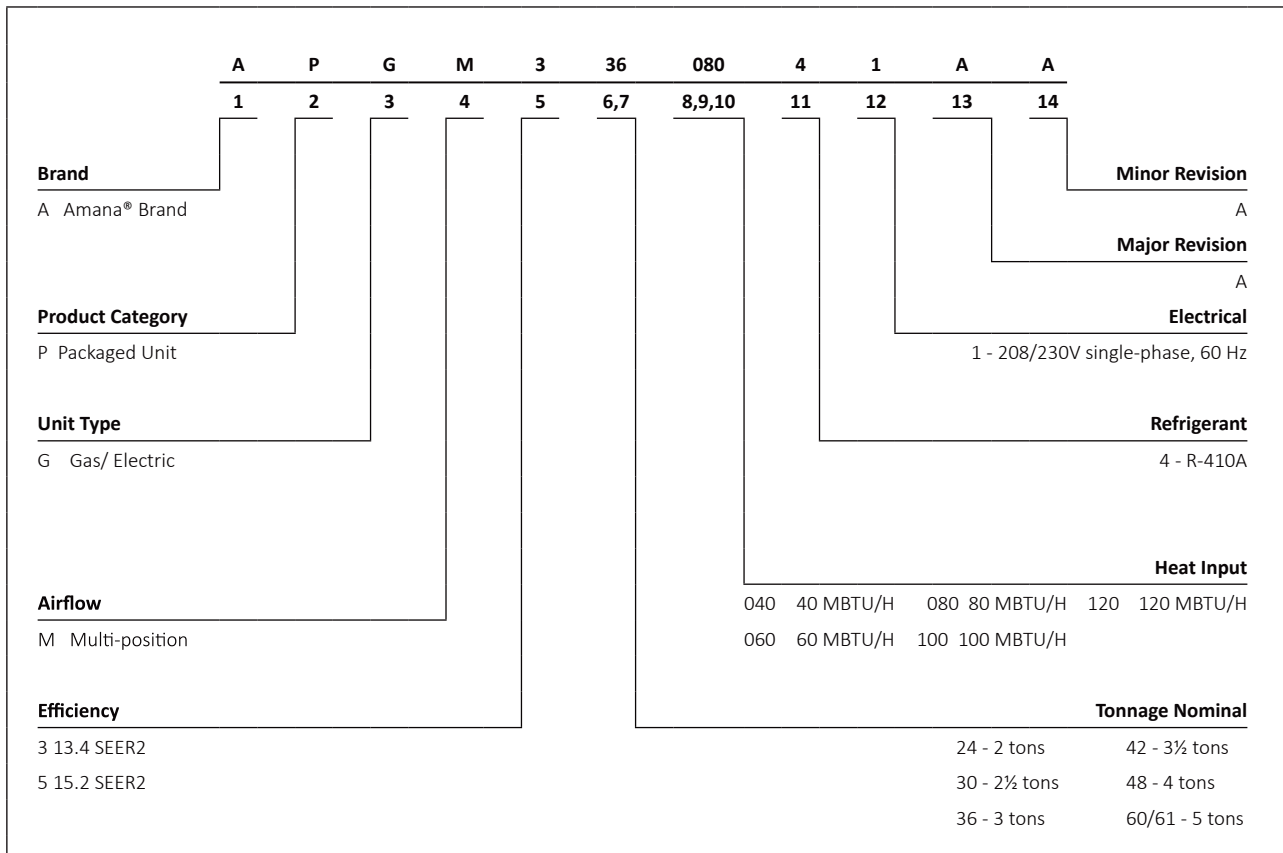
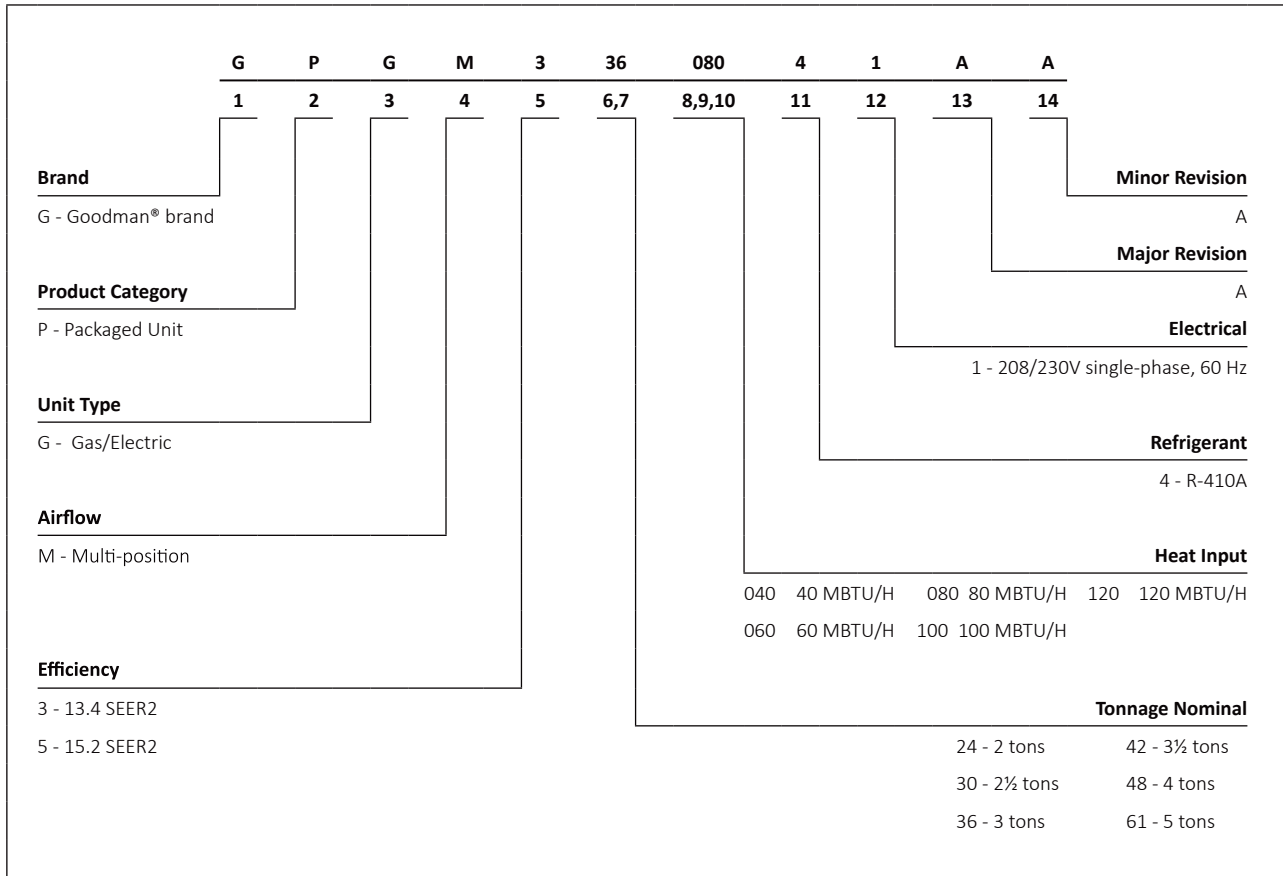

# PRODUCT IDENTIFICATION

Single Phase Package Gas Units	
Model #	Description
APG14[24-60]***M41AA	Amana® Brand Package Gas 14 Seer R410A Multi-Position gas/electric units. Initial release of single phase models.
APG1461***M41AA	Amana® Brand Package Gas 14 Seer R410A Multi-Position gas/electric units. Release of 5 Ton single phase models with a compressor change.
APG14[24-61]***M41AB	Amana® Brand Package Gas 14 Seer R410A Multi-Position gas/electric units. Release of single phase models with White Rodgers gas valves.

Single Phase Package Gas Units	
Model #	Description
GPG14[24-60]***M41AA	Goodman® Brand Package Gas 14 Seer R410A Multi-Position gas/electric units. Initial release of single phase models.
GPG1461***M41AA	Goodman® Brand Package Gas 14 Seer R410A Multi-Position gas/electric units. Release of 5 Ton single phase models with a compressor change.
GPG14[24-61]***M41AB	Goodman® Brand Package Gas 14 Seer R410A Multi-Position gas/electric units. Release of single phase models with White Rodgers gas valves.
GPG1430***M41BA	Goodman® Brand Package Gas 14 Seer R410A Multi-Position gas/electric units. Release of single phase models with Rechi compressor.
GPG1436***M41BA	Goodman® Brand Package Gas 14 Seer R410A Multi-Position gas/electric units. Release of single phase models with Rechi compressor.

Package Gas Units	
Model #	Description
A/GPG16[24-48]***M41AA	<u>A</u> mana® Brand / <u>G</u> oodman® Brand <u>P</u> ackage <u>G</u> as, up to 16 Seer R410A gas / electric units. Initial unit release meeting 16 SEER/12 EER energy efficiency requirements and DOE mandated 81% AFUE and "POWER OFF" requirements.
A/GPG161660***M41AA	<u>A</u> mana® Brand / <u>G</u> oodman® Brand <u>P</u> ackage <u>G</u> as, up to 16 Seer R410A gas / electric units. 5 Ton initial units release meeting 16 SEER/12 EER energy efficiency requirements and DOE mandated 81% AFUE and "POWER OFF" requirements.
A/GPGM3[24-61]***41A*	<u>A</u> mana® Brand / <u>G</u> oodman® Brand <u>P</u> ackage <u>G</u> as <u>E</u> lectric 13.4 SEER(2) R410A Multi-Position units. Initial release of models meeting DOE 2023 Regulatory Requirements.
A/GPGM5[24-61]***41A*	<u>A</u> mana® Brand / <u>G</u> oodman® Brand <u>P</u> ackage <u>G</u> as <u>E</u> lectric 15.2 SEER(2) R410A Multi-Position units. Initial release of models meeting DOE 2023 Regulatory Requirements.

*These units have R410A refrigerant*

# SYSTEM OPERATION

## COOLING

The refrigerant used in the system is R-410A. It is a clear, colorless, non-toxic and non-irritating liquid. R-410A is a 50:50 blend of R-32 and R-125. The boiling point at atmospheric pressure is -62.9°F.

A few of the important principles that make the refrigeration cycle possible are: heat always flows from a warmer to a cooler body. Under lower pressure, a refrigerant will absorb heat and vaporize at a low temperature. The vapors may be drawn off and condensed at a higher pressure and temperature to be used again.

The indoor evaporator coil functions to cool and dehumidify the air conditioned spaces through the evaporative process taking place within the coil tubes.

**NOTE: The pressures and temperatures shown in the refrigerant cycle illustrations on the following pages are for demonstration purposes only. Actual temperatures and pressures are to be obtained from the "Expanded Performance Chart".**

Liquid refrigerant at condensing pressure and temperatures, (270 psig and 122°F), leaves the outdoor condensing coil through the drier and is metered into the indoor coil through the metering device. As the cool, low pressure, saturated refrigerant enters the tubes of the indoor coil, a portion of the liquid immediately vaporizes. It continues to soak up heat and vaporizes as it proceeds through the coil, cooling the indoor coil down to about 48°F.

Heat is continually being transferred to the cool fins and tubes of the indoor evaporator coil by the warm system air. This warming process causes the refrigerant to boil. The heat removed from the air is carried off by the vapor.

As the vapor passes through the last tubes of the coil, it becomes superheated. That is, it absorbs more heat than is necessary to vaporize it. This is assurance that only dry gas will reach the compressor. Liquid reaching the compressor can weaken or break compressor valves.

The compressor increases the pressure of the gas, thus adding more heat, and discharges hot, high pressure super-heated gas into the outdoor condenser coil.

In the condenser coil, the hot refrigerant gas, being warmer than the outdoor air, first loses its superheat by heat transferred from the gas through the tubes and fins of the coil. The refrigerant now becomes saturated, part liquid, part vapor and then continues to give up heat until it condenses to a liquid alone. Once the vapor is fully liquefied, it continues to give up heat which subcools the liquid, and it is ready to repeat the cycle.

## HEATING

The heating cycle is accomplished by using a unique tubular design heat exchanger which provides efficient gas heating on either natural gas or propane gas fuels. The heat exchangers compact tubular construction provides excellent heat transfer for maximum operating efficiency.

In shot type gas burners with integral cross lighters are used eliminating the need for adjustable air shutters. The same burner is designed for use on either natural or propane gas fuels.

The induced draft blower draws fuel and combustion air into the burners and heat exchanger for proper combustion. A pressure switch is used in conjunction with the I. D. blower to detect a blocked flue condition.

Blower operation is controlled by the ignition control module. The module allows for field adjustment of the blower delay at the end of the heating cycle. The range of adjustment is for 90, 120, 150 or 180 seconds. The factory delay setting is 30 seconds delay on 150 seconds delay off.

## DIRECT SPARK IGNITION (DSI) SYSTEMS

A/GPGM3 units are equipped with a direct spark ignition system. Ignition is provided by 22,000 volt electronic spark. A flame sensor then monitors for the presence of flame and closes the gas valve if flame is lost.

## PCBAG123 IGNITION CONTROL SEQUENCE OF OPERATION

### CONTINUOUS FAN

1. When the thermostat calls for continuous fan (G) with out a call for heat or cooling, the indoor fan has a 7 second delay on make and energizes the "HEAT" speed. The fan remains energized as long as the call for fan remains without a call for heat or cooling. The fan call "G" has a 60 second delay on break. **NOTE:** When the Configuration tab is broken, the continuous fan mode "G" will have a 7 second delay on make and a 60 second delay on break and the "COOL" speed tap will be energized.
2. If a call for cool (Y) occurs during continuous fan, the blower will switch over to "COOL" speed.
3. If a call for heat (W) occurs during continuous fan, the blower will remain energized through the heat cycle or until "G" is de-energized.
4. The continuous fan operation will function while the control is in heat mode lockout.



# SYSTEM OPERATION

## COOL MODE

1. When the thermostat calls for cooling (“Y”), the control energizes the cooling speed fan after a 7 second on delay. The control provides a 3 minute anti-short cycle protection for the compressor. If the compressor has been off for 3 or more minutes, the compressor immediately energizes when the thermostat calls for cool. If the compressor has not been off for at least 3 minutes when a call for cool occurs, the control waits until 3 minutes has elapsed from the time the compressor was last de-energized before re-energizing the compressor.
2. When the thermostat removes the call for cooling (“Y”) the compressor is de-energized and the control de-energizes the cooling speed fan after a cooling off delay period of 60 seconds.

**NOTE: A call for cooling has priority over continuous fan. If G is energized while Y is energized, during the cooling fan on delay, the fan will remain off until the delay is over.**

**NOTE: The cooling fan operation will continue to function while the control is in heat lockout.**

**NOTE: If a call for heat exist with a call for cooling, the call for heat shall proceed as normal except the fan remains energized on cool speed.**

## HEAT MODE

1. CALL FOR HEAT - The thermostat calls for heat by energizing the “W” terminal. The control checks to see if the pressure switch is open. If the pressure switch is closed, the control will flash code “3” on the LED and wait indefinitely for the pressure switch to open. The control will lockout the call for heat if the pressure switch is closed before the induced draft motor is energized.
2. PRE-PURGE - The control energizes the induced draft motor, flashes code “2” on LED, and waits for the pressure switch to close. When the pressure switch has closed, the control stops flashing the LED and begins timing the 15 second pre-purge period. (**NOTE: Under normal operation, the LED will not flash if the pressure switch closes immediately after energizing the induced draft motor.**)
3. IGNITION - The control energizes the gas valve and spark. If flame is not established within 7 seconds, the gas valve and spark are de-energized and the control goes to an inter-purge. If flame is established, the spark is de-energized and the control goes to heat blower on delay.

4. Heat Blower On Delay - The control waits for 30 second heat fan on delay and then energizes the indoor blower heat speed. If the blower is already energized by a call for cooling or continuous fan, or in a blower off delay period, the on delay is skipped and control goes to steady heat.
5. STEADY HEAT - Control inputs are continuously monitored to ensure limit and pressure switches are closed, flame is established, and the thermostat call for heat remains.
6. POST PURGE - When the thermostat demand for heat is satisfied, the control immediately de-energizes the gas valve. The inducer output remains on for a 29 second post-purge period.
7. Heat Blower Off Delay - The indoor blower motor is de-energized after the selected blower off delay time. Blower timing begins when the thermostat is satisfied.

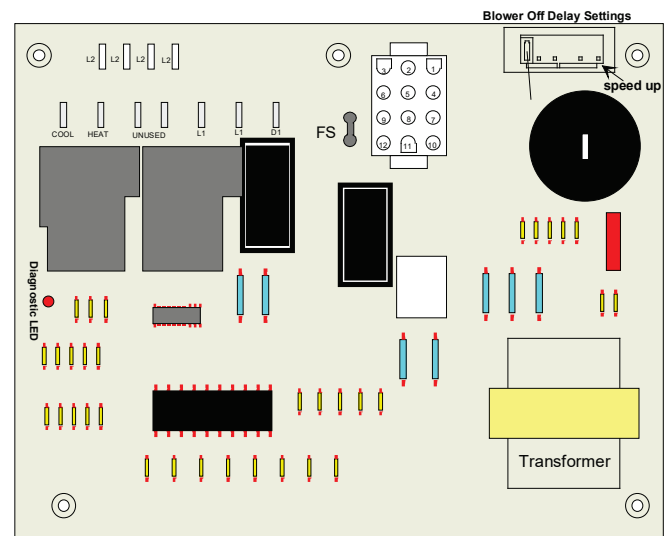

Pin	Voltage	Function
1	24VAC	24VAC Input (from Transformer)
2	24VAC	24VAC Common (Chassis Ground)
3	24VAC	Gas Valve Output
4	24VAC	Limit Switch Output
5	24VAC	Limit Switch Input (Common with Pin 9)
6	24VAC	Pressure Switch Input
7	24VAC	Thermostat Fan (G) Input
8	24VAC	Pressure Switch Output (Common with Pin 10)
9	24VAC	Thermostat "R" (Common with Pin 5)
10	24VAC	Thermostat Heat Input (W) (Common with Pin 8)
11	24VAC	Thermostat Cool Input (Y)
12	24VAC	Compressor Contactor Output

**TABLE 1: PCBAG123 SINGLE STAGE CONTROL CIRCUIT DEFINITIONS FOR 12-CIRCUIT CONNECTOR**

# SYSTEM OPERATION

## PCBAG127 IGNITION CONTROL SEQUENCE OF OPERATION (TWO STAGE CONTROL)

Terminal	Label
230VAC Line 1 Input (x2)	L1
230VAC Line 2 Input (x4)	L2
Indoor Blower Heat Speed	HEAT
Indoor Blower Cool Speed	COOL
Induced Drafter Blower Output	DI
Unused/Motor Speed Park Terminals (x2)	UNUSED
Flame Sensor	FS
Continuous Fan (G) / Economizer	ECON
Spark Igniter Output	SPARK

**TABLE 2: PCBAG123 SINGLE STAGE CONTROL TERMINAL DEFINITIONS**

Period	Timing
Pre-Purge	15 Seconds
Inter-Purge	15 Seconds
Post Purge	29 Seconds
Trial-for-Ignition (TFI)	7 Seconds
Flame Stabilization Period	10 Seconds
Heat ON Delay	30 Seconds
Heat OFF Delay	Selectable 120, 135 or 150 Seconds
Cool ON Delay	7 Seconds
Cool OFF Delay	60 Seconds
Ignition Attempts	3 Attempts
Recycles Infinite	4 Recycles (5 Flame Losses)
Automatic Restart	60 Minutes
Compressor Short Cycle Delay	3 Minutes

**TABLE 3: PCBAG123 SINGLE STAGE CONTROL TIMINGS**

System Status	LED Flashes
Normal	On
Internal Fault/Gas Valve Fault	Off
Ignition Lockout	1
Pressure Switch Stuck Closed	2
Pressure Switch Stuck Open	3
Open High Temperature Limit	4
Flame Detected with Gas Valve De-Energized	5
Compressor Short Cycle Delay Active	6

**TABLE 4: PCBAG123 SINGLE STAGE CONTROL LED STATUS CODES**

### HEATING OPERATION: LOW STAGE HEAT

1. Thermostat type is set to two-stage.
2. Thermostat "W1" input initiates low stage heating.
3. Induced draft blower is energized at high speed for the pre-purge period. Pre-purge timer begins after control recognizes pressure switch has closed.
4. Trial-for-ignition period begins after pre-purge period expires. Low and high stage gas valves are energized along with the igniter for trial-for-ignition period. Igniter is de-energized when flame is detected.
5. Flame is achieved and detected during trial-for-ignition period. Flame stabilization period begins when flame is detected.
6. De-energize high stage gas valve and switch induced draft blower to low speed within five seconds of flame detection.
7. Air circulating blower is energized at low heat speed after heat ON delay time expires. Heat ON delay timer begins when flame is detected.
8. Control monitors thermostat, flame, limit, and pressure switch inputs during low stage heating.
9. Thermostat "W1" input is removed.
10. Low stage gas valve is de-energized.
11. Induced draft blower remains energized at low speed for post purge period.
12. Air circulating blower remains energized at low heat speed for heat OFF delay. Heat OFF delay begins when "W1" input is removed.
13. Control returns to Standby and awaits next thermostat request.

### HEATING OPERATION: HIGH STAGE HEAT

1. Thermostat type is set to two-stage.
2. Thermostat "W1" and "W2" inputs initiate high stage heating.
3. Induced draft blower is energized at high speed for the pre-purge period. Pre-purge timer begins after control recognizes pressure switch has closed.
4. Trial-for-ignition period begins after pre-purge period expires. Low and high stage gas valves are energized along with the igniter for trial-for-ignition period. Igniter is de-energized when flame is detected.
5. Flame is achieved and detected during trial-for-ignition period. Flame stabilization period begins when flame is detected.
6. Gas valve and induced draft blower remain at high stage and high speed.
7. Air circulating blower is energized at high heat speed after heat ON delay time expires. Heat ON delay timer begins when flame is detected.
8. Control monitors thermostat, flame, limit, and pressure switch inputs during high stage heating.
9. Thermostat "W1" and "W2" inputs are removed.
10. High and low stage gas valves are de-energized.



# SYSTEM OPERATION

11. Induced draft blower switches from high speed to low speed and remains energized for post purge period.
12. Air circulating blower remains energized at high heat speed for High Stage Heat OFF Delay period then switches to low heat speed for the remainder of the selected heat OFF delay. Heat OFF delay begins when “W1” and “W2” inputs are removed.
13. Control returns to Standby and awaits next thermostat request.

## COOLING OPERATION: LOW STAGE COOL

1. Thermostat type is set to two-stage.
2. Thermostat “Y1” or thermostat “Y1” and “G” input initiates low stage cooling.
3. IDT/ODT/Pressure/Loss of Charge Switch circuits are checked for closed condition. Cooling operation can proceed only if these circuits are closed.
4. Low stage compressor output is energized.
5. Condenser fan motor is energized at low speed.
6. Air circulating blower is energized at low cool speed after cool ON delay expires. Cool ON delay timer begins when thermostat inputs are detected.
7. Control monitors thermostat, gas valve, flame, and IDT/ODT/Pressure/Loss of Charge Switches during low stage cooling.
8. Thermostat “Y1” or “Y1” and “G” inputs are removed.
9. Low stage compressor output is de-energized. Low speed condenser fan motor is de-energized.
10. Air circulating blower remains energized at low cool speed for the cool OFF delay. Cool OFF delay timer begins when thermostat input is removed.
11. Control returns to Standby and awaits next thermostat request.

## COOLING OPERATION: HIGH STAGE COOL

Thermostat type is set to two-stage. Thermostat “Y1” and “Y2” or “Y1”, “Y2” and “G” inputs initiate high stage cooling. IDT/ODT/Pressure/Loss of Charge Switch circuits are checked for closed condition. Cooling operation can proceed only if these circuits are closed.

1. Low and high stage compressor outputs are energized.
2. Condenser fan motor is energized at high speed.
3. Air circulating blower is energized at high cool speed after cool ON delay expires. Cool ON delay timer begins when thermostat inputs are detected.

Control monitors thermostat, gas valve, flame, and IDT/ODT/Pressure/Loss of Charge Switches during high stage cooling operation.

Thermostat “Y1” and “Y2” or “Y1”, “Y2” and “G” inputs are removed.

Low and high stage compressor outputs are de-energized. High speed condenser fan motor is de-energized.

4. Air circulating blower switches to low cool speed for the cool OFF delay. Cool OFF delay timer begins when thermostat input is removed.

Control returns to Standby and awaits next thermostat request.

## CONTINUOUS FAN OPERATION

1. Thermostat “G” input initiates Continuous Fan operation.
2. Air circulation blower shall be immediately energized at the continuous fan speed. For purposes of this specification, the continuous fan speed shall be the low heat speed.
3. Thermostat “G” input is removed.
4. Air circulation blower is immediately de-energized.
5. Control returns to Standby and awaits next thermostat request.

## PCBAG127 CONTROL BOARD



### DESCRIPTION

The ignition control is designed for use in gas heating/ electric cooling package equipment (rooftop applications) and operates with a two stage heat and two stage cooling system. It is a direct spark ignition system that uses a 22,000 volt spark to ignite the burners. A flame sensor is used to monitor the flame.

The board has the option of using a single or two stage thermostat. The board also controls the indoor blower and has an adjustable heat fan off delay.

There is also a fault recall button for recalling the last 5 fault codes. To recall the fault codes, depress the fault recall button for at least 2 seconds but not more than 4 seconds. To clear the fault code memory, depress the fault recall button for at least 5 seconds.

The following tables list the functions for the connectors and terminals, the timings, and the fault codes for the PCBAG127 control board.

 <b>WARNING</b>	
<b>HIGH VOLTAGE</b> DISCONNECT ALL POWER BEFORE SERVICING OR INSTALLING THIS UNIT. MULTIPLE POWER SOURCES MAY BE PRESENT. FAILURE TO DO SO MAY CAUSE PROPERTY DAMAGE, PERSONAL INJURY OR DEATH.	

# SYSTEM OPERATION

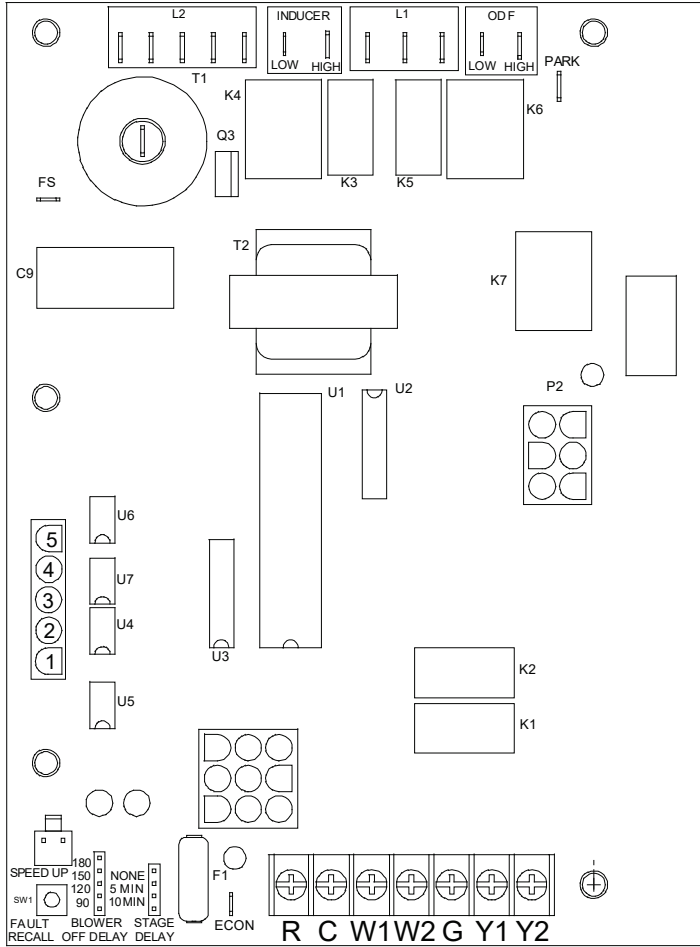

Pin	Voltage	Function
1	24VAC	Indoor/Outdoor Thermostat (IDT/ODT) Output
2	24VAC	High Stage Compressor Output
3	24VAC	Pressure Switch/Loss of Charge Switch Input
4	24VAC	Indoor/Outdoor Thermostat (IDT/ODT) Input
5	24VAC	Pressure Switch/Loss of Charge Switch Output
6	24VAC	Low Stage Compressor Output

**TABLE 1: CIRCUIT DEFINITIONS AND VOLTAGE RATINGS FOR THE 6-CIRCUIT CONNECTOR CIRCUITS**

Pin	Voltage	Function
1	24VAC	Limit Switch Output
2	24VAC	24VAC Input to Control
3	24VAC	Limit Switch Input
4	24VAC	Unused
5	24VAC	24VAC Common
6	24VAC	Pressure Switch Output
7	24VAC	Main Valve High Output
8	24VAC	Pressure Switch Input
9	Unused	Main Valve Low Output

**TABLE 2: CIRCUIT DEFINITIONS AND VOLTAGE RATINGS FOR THE 9-CIRCUIT CONNECTOR CIRCUITS**

Terminal	Label
Line Voltage L1	L1
Transformer Line L1	L1
Air Circulating Blower Line 1	L1
Induced Draft Blower Low Speed	DI Low or "Inducer Low"
Induced Draft Blower High Speed	DI High or "Inducer High"
Condenser Fan Motor Low Speed	ODF Low
Condenser Fan Motor High Speed	ODF High
Line Voltage L2	L2
Transformer Line L2	L2
Air Circulating Blower Line 2	L2
Induced Draft Blower Line 2	L2
Condenser Fan Motor Line 2	L2
Direct Spark Igniter	T1
Flame Detection	FS

**TABLE 3: HIGH VOLTAGE TERMINALS**

Period	Timing
Pre-Purge	15 Seconds
Inter-Purge	30 Seconds
Post Purge	30 Seconds
Trial-for-Ignition (TFI)	7 Seconds
Flame Stabilization Period	10 Seconds
Flame Failure Response Time	2 Seconds within Flame Stabilization Period 2 Seconds or Per ANSI Z21.20 Outside of Flame Stabilization Period
Low to High Stage Delay	Selectable 5 minutes or 10 minutes (Default = 10 minutes)
Heat ON Delay	30 Seconds
Heat OFF Delay	Selectable 90, 120, 150, or 180 Seconds (Default = 150 Seconds)
High Stage Heat OFF Delay	30 Seconds
Cool ON Delay	6 Seconds
Cool OFF Delay	45 Seconds
Continuous Fan ON Delay	0 Seconds
Continuous Fan OFF Delay	0 Seconds
Ignition Attempts	3
Recycles	Infinite
Automatic Restart	60 Minutes
Pressure Switch Lockout Delay	5 Minutes
Factory Test Mode Active Time	2 Minutes Maximum

**TABLE 4: CONTROL TIMINGS**

Color	Function	LED Flashes/Status
Red	Normal	On
	Intrnal/Gas Valve Fault	Off
	Lockout	1
	Pressure Switch Stuck Open	2
	Pressure Switch Stuck Closed	3
	Open High Temperature Limit	4
	Flame Detected with Gas Valve De-Energized	5
	Compressor Short Cycle Delay Active	6
	Limit Opened 5 Times in Same Call For Heat	7
Amber	Indoor Thermostat/Outdoor Thermostat is Open	8
	Pressure Switch/Loss of Charge Switch is Open	9
	Normal Flame	On
	No Flame Present	Off
	Low Flame Current	1
Flame Detected with Gas Valve De-energized	2	

**TABLE 5: LED STATUS CODES AND CORRESPONDING SYSTEM CONDITION**

# SYSTEM OPERATION

## TYPICAL PACKAGE COOLING OR PACKAGE GAS

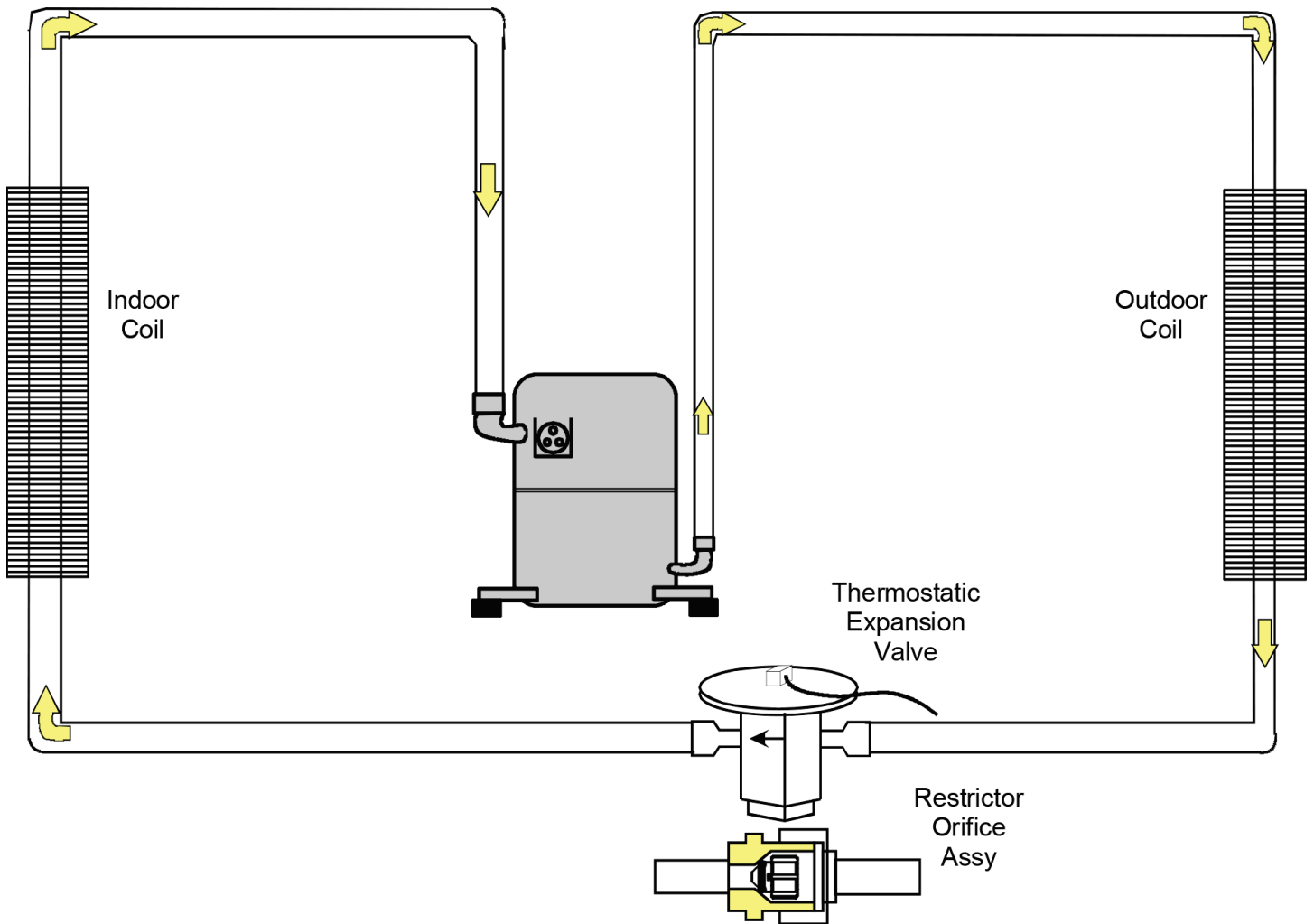

Either a thermostatic expansion valve or restrictor orifice assembly may be used depending on model, refer to the parts catalog for the model being serviced.

### RESTRICTOR ORIFICE ASSEMBLY IN COOLING OPERATION

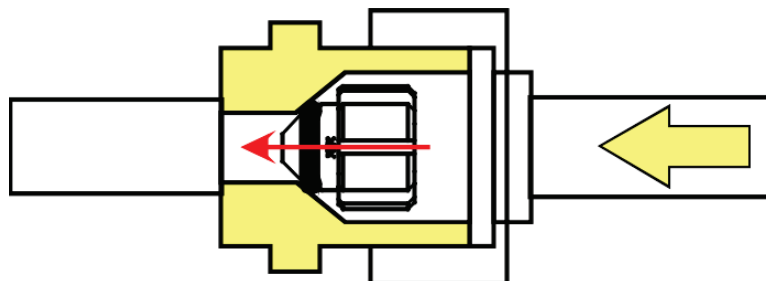



In the cooling mode, the orifice is pushed into its seat forcing refrigerant to flow through the metered hole in the center of the orifice.

# SCHEDULED MAINTENANCE

Package gas units require regularly scheduled maintenance to preserve high performance standards, prolong the service life of the equipment, and lessen the chances of costly failure.

In many instances the owner may be able to perform some of the maintenance; however, the advantage of a service contract, which places all maintenance in the hands of a trained serviceman, should be pointed out to the owner.

 <b>WARNING</b>	
<b>HIGH VOLTAGE</b> DISCONNECT ALL POWER BEFORE SERVICING OR INSTALLING THIS UNIT. MULTIPLE POWER SOURCES MAY BE PRESENT. FAILURE TO DO SO MAY CAUSE PROPERTY DAMAGE, PERSONAL INJURY OR DEATH.	

## ONCE A MONTH

1. Inspect the return filters of the evaporator unit and clean or change if necessary.

**NOTE: Depending on operation conditions, it may be necessary to clean or replace the filters more often. If permanent type filters are used, they should be washed with warm water and dried.**

2. When operating on the cooling cycle, inspect the condensate line piping from the evaporator coil. Make sure the piping is clear for proper condensate flow.

## ONCE A YEAR

### QUALIFIED SERVICE PERSONNEL ONLY

1. Clean the indoor and outdoor coils.
2. Clean the cabinet inside and out .
3. Motors are permanently lubricated and do not require oiling. **TO AVOID PREMATURE MOTOR FAILURE, DO NOT OIL.**
4. Manually rotate the outdoor fan and indoor blower to be sure they run freely.
5. Inspect the control panel wiring, compressor connections, and all other component wiring to be sure all connections are tight. Inspect wire insulation to be certain that it is good.
6. Check the contacts of the compressor contactor. If they are burned or pitted, replace the contactor.
7. Using a halide or electronic leak detector, check all piping and etc. for refrigerant leaks.
8. Check the combustion chamber (Heat Exchanger) for soot, scale, etc. Inspect all burners for lint and proper positioning.
9. Start the system, using the proper instrumentation check gas inlet and manifold pressures, burner flame and microamp signal. Adjust if necessary.

10. Start the system and run a Heating Performance Test. If the results of the test are not satisfactory, see the Servicing sections for the possible cause.

## TEST EQUIPMENT

Proper test equipment for accurate diagnosis is as essential as regular hand tools.

The following is a must for every service technician and service shop:

1. Thermocouple type temperature meter - measure dry bulb temperature.
2. Sling psychrometer - measure relative humidity and wet bulb temperature.
3. Volt-Ohm Meter - testing continuity, capacitors, motor windings and voltage.
4. Accurate Leak Detector - testing for refrigerant leaks.
5. High Vacuum Pump - evacuation.
6. Electric Vacuum Gauge, Manifold Gauges and high vacuum hoses - to measure and obtain proper vacuum.
7. Accurate Charging Cylinder or Electronic Scale - measure proper refrigerant charge.
8. Inclined Manometer - measure static pressure and pressure drop across coils.

Other recording type instruments can be essential in solving abnormal problems, however, in many instances they may be rented from local sources.

Proper equipment promotes faster, more efficient service, and accurate repairs with less call backs.

## HEATING PERFORMANCE TEST

Before attempting to diagnose an operating fault code, run a Heating Performance Test to determine if the heating system is performing within 5% of the BTU input found on the rating plate of the unit being tested. To conduct a heating performance test, the BTU input to the unit must be calculated (see Clocking a Gas Meter). Before clocking a gas meter, contact your local utility to provide the caloric value (BTU content) of the natural gas in the area.

It is also important to confirm the airflow (CFM) is within the temperature rise range (see Airflow Data in spec sheet) and external static pressure range (approximately 0.5" water column). How-to instructions can be found in the service manual under Checking External Static Pressure and Checking Temperature Rise.

## CLOCKING A GAS METER

1. Turn off all gas appliances in the home.
2. Turn on the furnace. Ensure the furnace is operating at a 100% firing rate on 2 stage and modulating furnace product.
3. Once heating cycle is at a steady state (typically 15 minutes of operation), use a stopwatch to time how long it takes the smallest unit of measure dial on the

# SCHEDULED MAINTENANCE

gas meter to make a full revolution. In Table 1, one cubic foot is selected. The smallest unit of measure will vary depending on the gas meter.

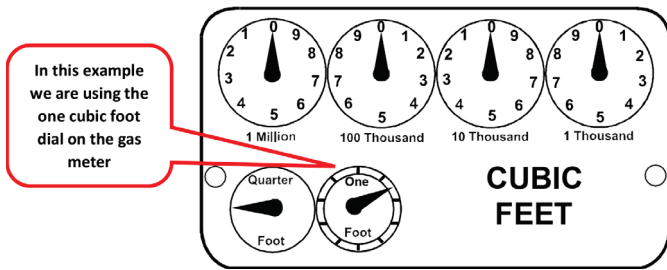

TABLE 1

- Using Table 2 below, find the number of seconds it took for the dial to make a full revolution. To the right of that number of seconds and below the Size of Test Dial (selected in step 3 and shown in Table 1) will be the Cubic Feet per Hour (CFH).
- Use this formula to verify the Cubic Feet per Hour (CFH) input determined in step 4 is correct:  

$$(3600 \times \text{Gas Meter Dial Size}) / \text{Time (seconds)} = \text{Cubic Feet per Hour (CFH)}$$

3600 is used as there are 60 seconds in a minute and 60 minutes in an hour.  
 $60 \times 60 = 3600$

- Check with your local utility for actual BTU content (caloric value) of natural gas in the area (the average is 1025 BTU's).

Locate 40 seconds for one revolution in the chart below

Then locate the 1 cu ft dial column and select the corresponding CFH from the 40 seconds for one revolution row

GAS RATE -- CUBIC FEET PER HOUR											
Seconds for One Revolution	Size of Test Dial					Seconds for One Revolution	Size of Test Dial				
	1/4 cu/ft	1/2 cu/ft	1 cu/ft	2 cu/ft	5 cu/ft		1/4 cu/ft	1/2 cu/ft	1 cu/ft	2 cu/ft	5 cu/ft
10	90	180	360	720	1800	36	25	50	100	200	500
11	82	164	327	655	1636	37	--	--	97	195	486
12	75	150	300	600	1500	38	23	47	95	189	474
13	69	138	277	555	1385	39	--	--	92	185	462
14	64	129	257	514	1286	40	22	45	90	180	450
15	60	120	240	480	1200	41	--	--	--	176	439
16	56	113	225	450	1125	42	21	43	86	172	429
17	53	106	212	424	1059	43	--	--	--	167	419
18	50	100	200	400	1000	44	--	41	82	164	409
19	47	95	189	379	947	45	20	40	80	160	400
20	45	90	180	360	900	46	--	--	78	157	391
21	43	86	171	343	857	47	19	38	76	153	383
22	41	82	164	327	818	48	--	--	75	150	375
23	39	78	157	313	783	49	--	--	--	147	367
24	37	75	150	300	750	50	18	36	72	144	360
25	36	72	144	288	720	51	--	--	--	141	355
26	34	69	138	277	692	52	--	--	69	138	346
27	33	67	133	265	667	53	17	34	--	136	340
28	32	64	129	257	643	54	--	--	67	133	333
29	31	62	124	248	621	55	--	--	--	131	327
30	30	60	120	240	600	56	16	32	64	129	321
31	--	--	116	232	581	57	--	--	--	126	316
32	28	56	113	225	563	58	--	31	62	124	310
33	--	--	109	218	545	59	--	--	--	122	305
34	26	53	106	212	529	60	15	30	60	120	300
35	--	--	103	206	514	--	--	--	--	--	--

TABLE 2

- Use this formula to calculate the BTU/HR input (See BTU/HR Calculation Example):  
**Cubic Feet per Hour (CFH) x BTU content of your natural gas = BTU/HR input**
- Should the figure you calculated not fall within five (5) percent of the nameplate rating of the unit, adjust the gas valve pressure regulator or resize orifices. To adjust the pressure regulator on the gas valve, turn downward (clockwise) to increase pressure and input, and upward (counterclockwise) to decrease pressure and input. A properly operating unit must have the BTU per hour input and CFM of air, within the limits shown to prevent short cycling of the equipment. As the external static pressure goes up, the temperature rise will also increase. Consult the proper tables for temperature rise limitation.

### BTU/HR CALCULATION EXAMPLE:

The unit being tested takes 40 seconds for the 1 cubic foot dial to make one complete revolution. Using the chart, this translates to 90 cubic feet per hour. Based upon the assumption that one cubic foot of natural gas has 1,025 BTU's (Check with your local utility for actual BTU content), the calculated input is 92,250 BTU's per hour.

**Furnace Nameplate Input in this example: 90,000 BTU/HR**

**Calculated Gas Input in this example: 92,250 BTU/HR**  
**This example is within the 5% tolerance input and does not need adjustment.**

# SERVICING

## CHECKING VOLTAGE

**WARNING**

**HIGH VOLTAGE!**  
DISCONNECT ALL POWER BEFORE SERVICING OR INSTALLING. MULTIPLE POWER SOURCES MAY BE PRESENT. FAILURE TO DO SO MAY CAUSE PROPERTY DAMAGE, PERSONAL INJURY OR DEATH.

1. Remove doors, control panel cover, etc. from unit being tested.

With power ON:

**WARNING**

**LINE VOLTAGE NOW PRESENT.**

2. Using a voltmeter, measure the voltage across terminals L1 and L2 of the contactor.
3. No reading - indicates open wiring, open fuse(s) no power or etc. from unit to fused disconnect service. Repair as needed.
4. If incoming voltage is within the range listed in the chart below, energize the unit.
5. Using a voltmeter, measure the voltage with the unit starting and operating to determine if voltage is within the range listed in the chart below.
6. If the voltage falls below the minimum voltage, check the line wire size. Long runs of undersized wire can cause low voltage. If the wire size is adequate, notify the local power company regarding either low or high voltage.

## UNIT VOLTAGE

Rated Voltage	Minimum Supply Voltage	Maximum Supply Voltage
208/230V	197	253

## CHECKING WIRING

**WARNING**

**HIGH VOLTAGE!**  
DISCONNECT ALL POWER BEFORE SERVICING OR INSTALLING. MULTIPLE POWER SOURCES MAY BE PRESENT. FAILURE TO DO SO MAY CAUSE PROPERTY DAMAGE, PERSONAL INJURY OR DEATH.

1. Check wiring visually for signs of overheating, damaged insulation and loose connections.
2. Use an ohmmeter to check continuity of any suspected open wires.

3. If any wires must be replaced, replace with comparable gauge and insulation thickness.

BRANCH CIRCUIT AMPACITY	15	20	25	30	35	40	45	50
SUPPLY WIRE LENGTH - FEET								
200	6	4	4	4	3	3	2	2
150	8	6	6	4	4	4	3	3
100	10	8	8	6	6	6	4	4
50	14	12	10	10	8	8	6	6

**WIRING TABLE**

## CHECKING THERMOSTAT AND WIRING

Thermostat Wiring: The maximum wire length for 18 AWG thermostat wire is 100 feet.

### THERMOSTAT WIRING - SINGLE STAGE MODELS

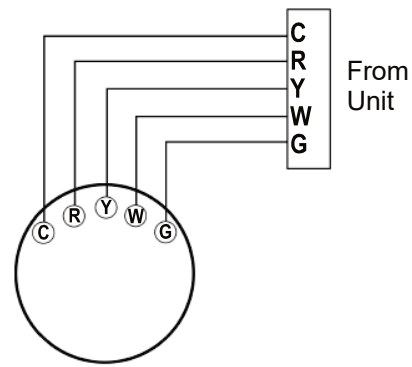

**SINGLE STAGE HEATING & COOLING THERMOSTAT DIAGRAM**

### THERMOSTAT WIRING - TWO STAGE MODELS

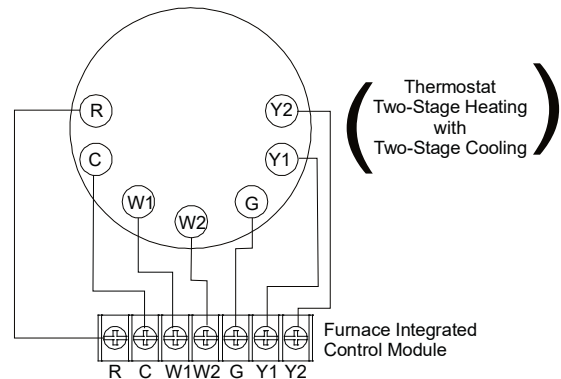

**TWO-STAGE HEATING WITH TWO-STAGE COOLING THERMOSTAT DIAGRAM**

### SINGLE STAGE THERMOSTAT - TWO-STAGE MODELS

To use a single stage thermostat, move jumper located to the left of the terminal strip labeled "Stage Delay" from NONE to "5" or "10" minutes. This selection will cause the control to run on low stage for the selected time (5 or 10 minutes) then shift to HIGH STAGE. This option controls both cooling and heating modes. If the jumper is not moved, only low-stage cool and low-stage heat will operate.



# SERVICING

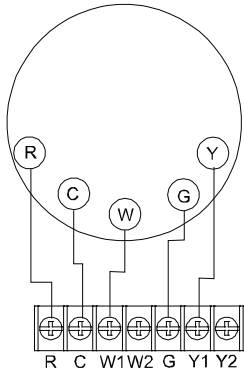

5 MINUTE DELAY PERIOD WITH JUMPER IN THIS POSITION

NONE  
5 MIN  
10 MIN

10 MINUTE DELAY PERIOD WITH JUMPER IN THIS POSITION

NONE  
5 MIN  
10 MIN

## TWO-STAGE HEATING (TIMED) AND TWO-STAGE COOLING (TIMED) WITH SINGLE STAGE THERMOSTAT DIAGRAM

A step-down transformer (208/240 volt primary to 24 volt secondary) is provided with each unit. This allows ample capacity for use with resistance heaters. The outdoor sections do not contain a transformer.

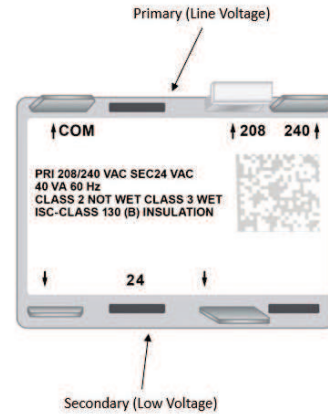

**WARNING**

LINE VOLTAGE NOW PRESENT.

With power ON, thermostat calling for cooling:

1. Use a voltmeter to check for 24 volts at thermostat wires C and Y in the condensing unit control panel.
2. No voltage indicates trouble in the thermostat, wiring or external transformer source.
3. Check the continuity of the thermostat and wiring. Repair or replace as necessary.

### INDOOR BLOWER MOTOR

With power ON:



**WARNING**

LINE VOLTAGE NOW PRESENT.

1. Set fan selector switch at thermostat to "ON" position.
2. With voltmeter, check for 24 volts at wires C and G.
3. No voltage indicates the trouble is in the thermostat or wiring.
4. Check the continuity of the thermostat and wiring. Repair or replace as necessary.

### CHECKING TRANSFORMER AND CONTROL CIRCUIT



**WARNING**

**HIGH VOLTAGE!**  
DISCONNECT ALL POWER BEFORE SERVICING OR INSTALLING. MULTIPLE POWER SOURCES MAY BE PRESENT. FAILURE TO DO SO MAY CAUSE PROPERTY DAMAGE, PERSONAL INJURY OR DEATH.



**WARNING**

DISCONNECT ALL POWER BEFORE SERVICING.

1. Remove control panel cover, or etc., to gain access to transformer.

With power ON:



**WARNING**

LINE VOLTAGE NOW PRESENT.

2. Using a voltmeter, check voltage across secondary voltage side of transformer (R to C).
3. No voltage indicates faulty transformer, bad wiring, or bad splices.
4. Check transformer primary voltage at incoming line voltage connections and/or splices.
5. If line voltage available at primary voltage side of transformer and wiring and splices good, transformer is inoperative. Replace.

### CHECKING CONTACTOR AND/OR RELAYS



**WARNING**

**HIGH VOLTAGE!**  
DISCONNECT ALL POWER BEFORE SERVICING OR INSTALLING. MULTIPLE POWER SOURCES MAY BE PRESENT. FAILURE TO DO SO MAY CAUSE PROPERTY DAMAGE, PERSONAL INJURY OR DEATH.



# SERVICING

The compressor contactor and other relay holding coils are wired into the low or line voltage circuits. When the control circuit is energized, the coil pulls in the normally open contacts or opens the normally closed contacts. When the coil is de-energized, springs return the contacts to their normal position.



**NOTE: Most single phase contactors break only one side of the line (L1), leaving 115 volts to ground present at most internal components.**

1. Remove the leads from the holding coil.
2. Using an ohmmeter, test across the coil terminals.

If the coil does not test continuous, replace the relay or contactor.

## CHECKING CONTACTOR CONTACTS

### SINGLE PHASE

 <b>WARNING</b>
<p><b>HIGH VOLTAGE!</b>  <b>DISCONNECT ALL POWER BEFORE SERVICING OR INSTALLING. MULTIPLE POWER SOURCES MAY BE PRESENT. FAILURE TO DO SO MAY CAUSE PROPERTY DAMAGE, PERSONAL INJURY OR DEATH.</b></p> 

1. Disconnect the wire leads from the terminal (T) side of the contactor.
2. With power ON, energize the contactor.

 <b>WARNING</b>
<b>LINE VOLTAGE NOW PRESENT.</b>

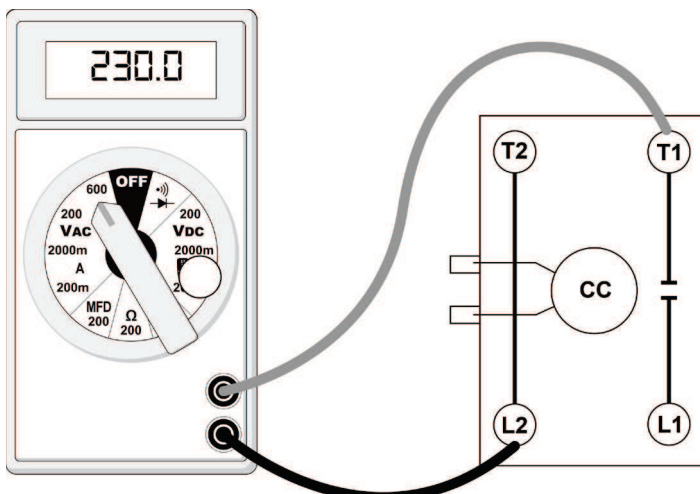

**TESTING COMPRESSOR CONTACTOR (SINGLE PHASE)**



3. Using a voltmeter, test across terminals.
  - a. L1 - L2 - No voltage. Check breaker or fuses on main power supply.
  - b. T1 to T2 - Meter should read the same as L1 to L2 in step A. If voltage readings are not the same as step A, replace contactor.

If a no voltage reading is obtained - replace the contactor.

## CHECKING FAN RELAY CONTACTS

The fan relays are incorporated into the control board. See Testing Ignition Control Module for checking control board.

## CHECKING HIGH PRESSURE CONTROL

 <b>WARNING</b>
<p><b>HIGH VOLTAGE!</b>  <b>DISCONNECT ALL POWER BEFORE SERVICING OR INSTALLING. MULTIPLE POWER SOURCES MAY BE PRESENT. FAILURE TO DO SO MAY CAUSE PROPERTY DAMAGE, PERSONAL INJURY OR DEATH.</b></p> 

The high pressure control senses the pressure in the liquid line. If abnormally high condensing pressures develop, the contacts of the control open, breaking the control circuit before the compressor motor overloads. This control is automatically reset.

1. Using an ohmmeter, check across terminals of high pressure control, with wire removed. If not continuous, the contacts are open.
2. Attach a gauge to the dill valve port on the base valve.

With power ON:

 <b>WARNING</b>
<b>LINE VOLTAGE NOW PRESENT.</b>

3. Start the system and place a piece of cardboard in front of the condenser coil, raising the condensing pressure.
4. Check pressure at which the high pressure control cuts-out.

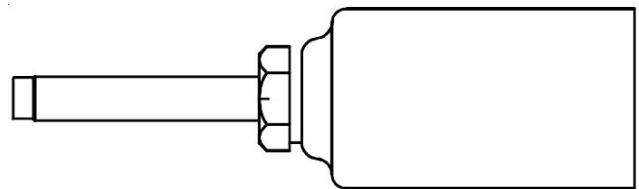

If it cuts-out at 660 PSIG  $\pm$  10 PSIG, it is operating normally. If it cuts out below this pressure range, replace the control. The control should reset at 420 PSIG  $\pm$  25 PSIG.

# SERVICING

## CHECKING LOW PRESSURE CONTROL

The low pressure control senses the pressure in the suction line and will open its contacts on a drop in pressure. The low pressure control will automatically reset itself with a rise in pressure.

The low pressure control is designed to cut-out (open) at approximately 55 PSIG  $\pm$  7 PSIG. It will automatically cut-in (close) at approximately 95 PSIG  $\pm$  7 PSIG.

Test for continuity using a VOM and if not as above, replace the control.

## CHECKING CAPACITOR

### CAPACITOR, RUN

A run capacitor is wired across the auxiliary and main windings of a single phase permanent split capacitor motor. The capacitor's primary function is to reduce the line current while greatly improving the torque characteristics of a motor. This is accomplished by using the 90° phase relationship between the capacitor current and voltage in conjunction with the motor windings so that the motor will give two phase operation when connected to a single phase circuit. The capacitor also reduces the line current to the motor by improving the power factor.

### CAPACITOR, START

### SCROLL COMPRESSOR MODELS

Hard start components are not required on Scroll compressor equipped units due to a non-replaceable check valve located in the discharge line of the compressor. However hard start kits are available and may improve low voltage starting characteristics.

This check valve closes off high side pressure to the compressor after shut down allowing equalization through the scroll flanks. Equalization requires only about one or two seconds during which time the compressor may turn backwards.

Your unit comes with a 180-second anti-short cycle to prevent the compressor from starting and running backwards.

### MODELS EQUIPPED WITH A HARD START DEVICE

A start capacitor is wired in parallel with the run capacitor to increase the starting torque. The start capacitor is of the electrolytic type, rather than metallized polypropylene as used in the run capacitor.

A switching device must be wired in series with the capacitor to remove it from the electrical circuit after the compressor starts to run. Not removing the start capacitor will overheat the capacitor and burn out the compressor windings.

These capacitors have a 15,000 ohm, 2 watt resistor wired across its terminals. The object of the resistor is to discharge the capacitor under certain operating conditions, rather than having it discharge across the closing of the contacts within the switching device such as the Start Relay, and to reduce the chance of shock to the servicer. See the Servicing Section for specific information concerning capacitors.

### RELAY, START

A potential or voltage type relay is used to take the start capacitor out of the circuit once the motor comes up to speed. This type of relay is position sensitive. The normally closed contacts are wired in series with the start capacitor and the relay holding coil is wired parallel with the start winding. As the motor starts and comes up to speed, the increase in voltage across the start winding will energize the start relay holding coil and open the contacts to the start capacitor.

## TESTING START RELAY KITS

### TESTING COIL RELAY

1. Disconnect power to unit.
2. Disconnect all wiring.
3. Measure the resistance of the coil between terminals 2 & 5.
4. If the coil reads open or shorted, replace the relay.

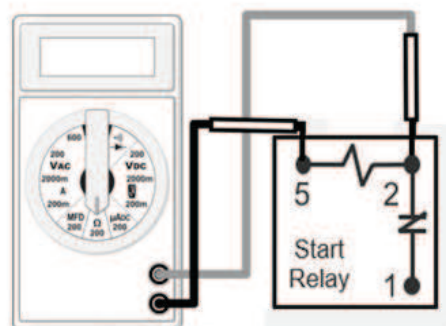

TESTING START RELAY COIL RESISTANCE

### TESTING RELAY CONTACTS

#### TESTING CONTACTS RESISTANCE

- a. Disconnect power to unit.
- b. Disconnect all wiring to the start relay.
- c. Measure the resistance of the contacts between terminals 1 & 2.
- d. If the contacts read open, replace the relay.

#### TESTING CONTACTS VOLTAGE

- a. With power on, provide a call for cool to energize the compressor.
- b. With the compressor running, use a voltmeter to measure the voltage between terminals 1 & 2.
- c. Voltage reading of zero indicates that the relay's contacts are stuck, replace the relay.

# SERVICING

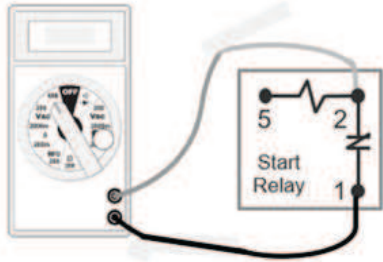

TESTING START RELAY CONTACTS

## CAPACITANCE CHECK (MFD)



**WARNING**

DISCHARGE CAPACITOR THROUGH A 20 TO 30 OHM RESISTOR BEFORE HANDLING.

1. Turn power off to unit.
2. Discharge capacitor through a 20Ω - 30Ω resistor.
3. Remove wires from capacitor.
4. Use multi-meter check micro-farads (MFD) of the capacitor.
5. Place leads from C – HERM.
6. Place leads from C – FAN.
7. Compare to capacitor rating label. If the reading is within the tolerance listed on rating label the capacitor is good. If the reading is lower, the capacitor is bad and must be replaced.

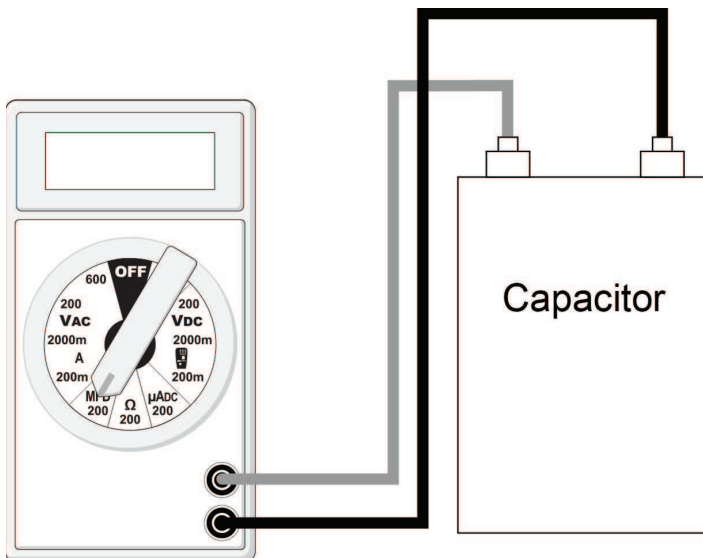

TESTING CAPACITANCE

## CHECKING FAN AND BLOWER MOTOR WINDINGS (PSC MOTORS)

The auto reset fan motor overload is designed to protect the motor against high temperature and high amperage conditions by breaking the common circuit within the motor, similar to the compressor internal overload. However, heat generated within the motor is faster to dissipate than the compressor, allow at least 45 minutes for the overload to reset, then retest.



**WARNING**

HIGH VOLTAGE!  
DISCONNECT ALL POWER BEFORE SERVICING OR INSTALLING. MULTIPLE POWER SOURCES MAY BE PRESENT. FAILURE TO DO SO MAY CAUSE PROPERTY DAMAGE, PERSONAL INJURY OR DEATH.



1. Remove the motor leads from its respective connection points and capacitor (if applicable).
2. Check the continuity between each of the motor leads.
3. Touch one probe of the ohmmeter to the motor frame (ground) and the other probe in turn to each lead.

If the windings do not test continuous or a reading is obtained from lead to ground, replace the motor.

## CHECKING ECM MOTOR WINDINGS



**WARNING**

HIGH VOLTAGE!  
DISCONNECT ALL POWER BEFORE SERVICING OR INSTALLING. MULTIPLE POWER SOURCES MAY BE PRESENT. FAILURE TO DO SO MAY CAUSE PROPERTY DAMAGE, PERSONAL INJURY OR DEATH.



1. Disconnect the 5-pin and the 16-pin connectors from the ECM power head.
2. Remove the 2 screws securing the ECM power head and separate it from the motor.
3. Disconnect the 3-pin motor connector from the power head and lay it aside.
4. Using an ohmmeter, check the motor windings for continuity to ground (pins to motor shell). If the ohmmeter indicates continuity to ground, the motor is defective and must be replaced.
5. Using an ohmmeter, check the windings for continuity (pin to pin). If no continuity is indicated, the thermal limit (over load) device may be open. Allow motor to cool and retest.

# SERVICING

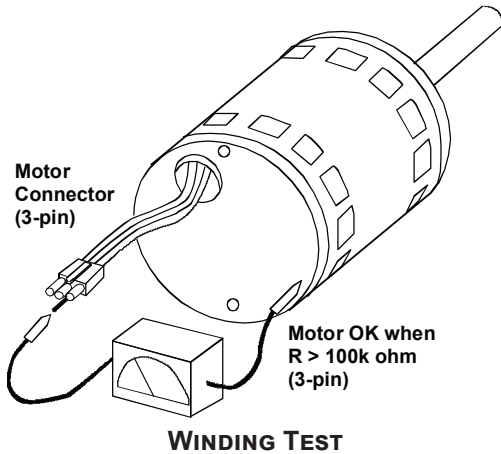

## CHECKING EEM MOTORS

The EEM motor is a one piece, fully encapsulated, 3 phase brushless DC (single phase AC input) motor with ball bearing construction. The EEM motor features an integral control module.

**NOTE: The GE TECMate will not currently operate the EEM motor.**

1. Using a voltmeter, check for 230 volts to the motor connections L and N. If 230 volts is present, proceed to step 2. If 230 volts is not present, check the line voltage circuit to the motor.
2. Using a voltmeter, check for 24 volts from terminal C to either terminal 1, 2, 3, 4, or 5, depending on which tap is being used, at the motor. If voltage present, proceed to step 3. If no voltage, check 24 volt circuit to motor.
3. If voltage was present in steps 1 and 2, the motor has failed and will need to be replaced.

**NOTE: When replacing motor, ensure the belly band is between the vents on the motor and the wiring has the proper drip loop to prevent condensate from entering the motor.**

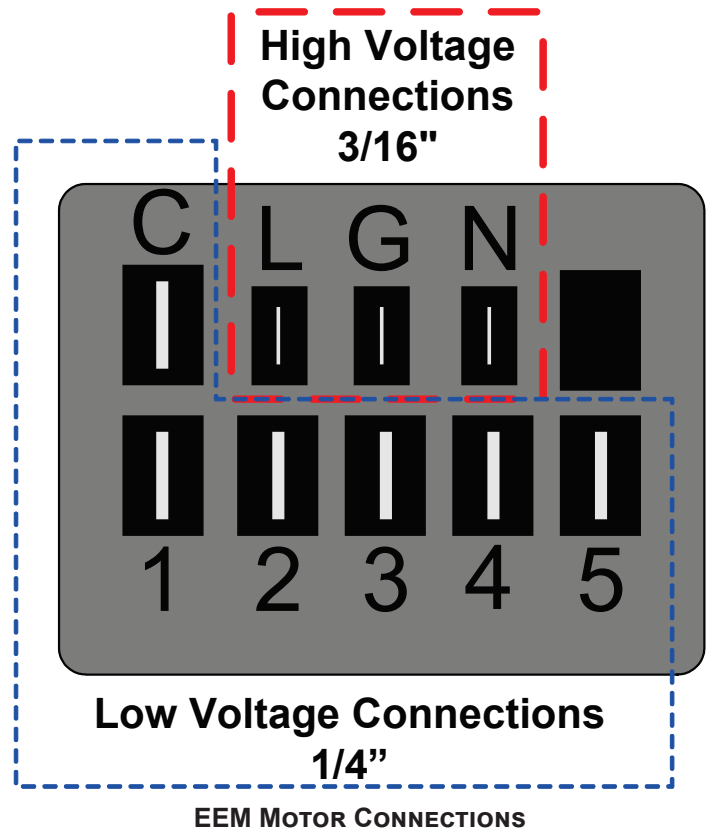

## CHECKING ECM MOTORS

An ECM is an *Electronically Commutated Motor* which offers many significant advantages over PSC motors. The ECM has near zero rotor loss, synchronous machine operation, variable speed, low noise, and programmable air flow. Because of the sophisticated electronics within the ECM motor, some technicians are intimidated by the ECM motor; however, these fears are unfounded. GE/Regal Beloit offers two ECM motor testers, and with a VOM meter, one can easily perform basic troubleshooting on ECM motors. An ECM motor requires power (line voltage) and a signal (24 volts) to operate. The ECM motor stator contains permanent magnet. As a result, the shaft feels "rough" when turned by hand. This is a characteristic of the motor, not an indication of defective bearings.



**WARNING**

**LINE VOLTAGE NOW PRESENT.**

1. Disconnect the 5-pin connector from the motor.
2. Using a volt meter, check for line voltage at terminals #4 & #5 at the power connector. If no voltage is present:
3. Check the unit for incoming power.
4. Check the control board.
5. If line voltage is present, reinsert the 5-pin connector and remove the 16-pin connector.
6. Check for signal (24 volts) at the transformer.
7. Check for signal (24 volts) from the thermostat to the "G" terminal at the 16-pin connector.



# SERVICING

8. Using an ohmmeter, check for continuity from the #1 & #3 (common pins) to the transformer neutral or "C" thermostat terminal. If you do not have continuity, the motor may function erratically. Trace the common circuits, locate and repair the open neutral.
9. Set the thermostat to "Fan-On". Using a voltmeter, check for 24 volts between pin #15 (G) and common.
10. Disconnect power to compressor. Set thermostat to call for cooling. Using a voltmeter, check for 24 volts at pin #6 and or #14.
11. Set the thermostat to a call for heating. Using a voltmeter, check for 24 volts at pin #2 and/or #11.

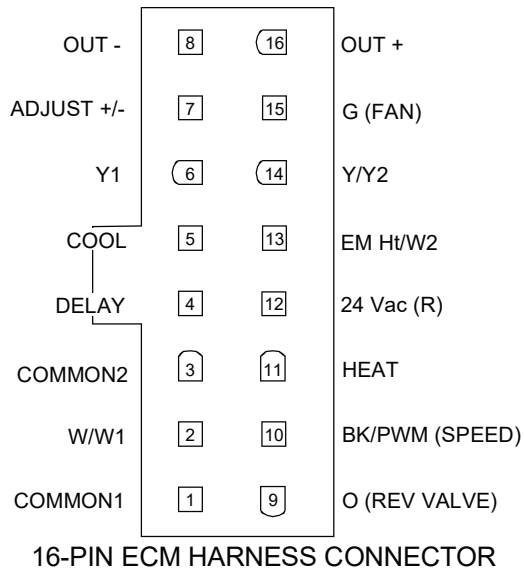
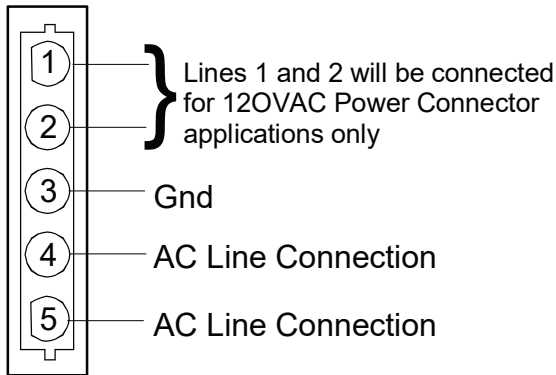

If you do not read voltage and continuity as described, the problem is in the control or interface board, but not the motor. If you register voltage as described, the ECM power head is defective and must be replaced.

## CHECKING ECM MOTOR WINDINGS

**WARNING**

**HIGH VOLTAGE!**  
**DISCONNECT ALL POWER BEFORE SERVICING OR INSTALLING. MULTIPLE POWER SOURCES MAY BE PRESENT. FAILURE TO DO SO MAY CAUSE PROPERTY DAMAGE, PERSONAL INJURY OR DEATH.**

1. Disconnect the 5-pin and the 16-pin connectors from the ECM power head.
2. Remove the 2 screws securing the ECM power head and separate it from the motor.
3. Disconnect the 3-pin motor connector from the power head and lay it aside.
4. Using an ohmmeter, check the motor windings for continuity to ground (pins to motor shell). If the ohmmeter indicates continuity to ground, the motor is defective and must be replaced.
5. Using an ohmmeter, check the windings for continuity (pin to pin). If no continuity is indicated, the thermal limit (over load) device may be open. Allow motor to cool and retest.

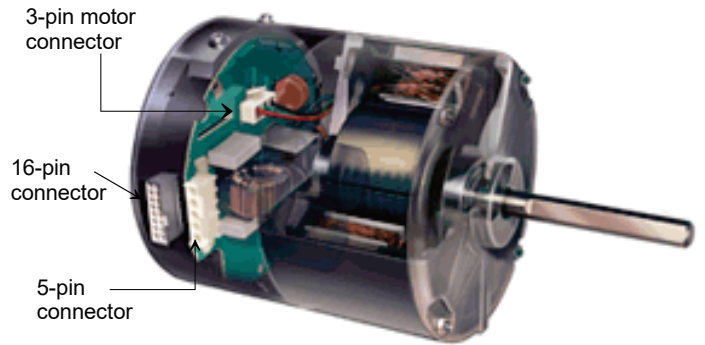

## CHECKING COMPRESSOR

**WARNING**

**HERMETIC COMPRESSOR ELECTRICAL TERMINAL VENTING CAN BE DANGEROUS. WHEN INSULATING MATERIAL WHICH SUPPORTS A HERMETIC COMPRESSOR OR ELECTRICAL TERMINAL SUDDENLY DISINTEGRATES DUE TO PHYSICAL ABUSE OR AS A RESULT OF AN ELECTRICAL SHORT BETWEEN THE TERMINAL AND THE COMPRESSOR HOUSING, THE TERMINAL MAY BE EXPELLED, VENTING THE VAPOR AND LIQUID CONTENTS OF THE COMPRESSOR HOUSING AND SYSTEM.**

If the compressor terminal PROTECTIVE COVER and gasket (if required) are not properly in place and secured, there is a remote possibility if a terminal vents, that the vaporous and liquid discharge can be ignited, spouting flames several feet, causing potentially severe or fatal injury to anyone in its path.

This discharge can be ignited external to the compressor if the terminal cover is not properly in place and if the discharge impinges on a sufficient heat source.



# SERVICING

Ignition of the discharge can also occur at the venting terminal or inside the compressor, if there is sufficient contaminant air present in the system and an electrical arc occurs as the terminal vents.

Ignition cannot occur at the venting terminal without the presence of contaminant air, and cannot occur externally from the venting terminal without the presence of an external ignition source.

Therefore, proper evacuation of a hermetic system is essential at the time of manufacture and during servicing.

To reduce the possibility of external ignition, all open flame, electrical power, and other heat sources should be extinguished or turned off prior to servicing a system.



## RESISTANCE TEST

Each compressor is equipped with an internal overload.

The line break internal overload senses both motor amperage and winding temperature. High motor temperature or amperage heats the disc causing it to open, breaking the common circuit within the compressor on single phase units.

Heat generated within the compressor shell, usually due to recycling of the motor, high amperage or insufficient gas to cool the motor, is slow to dissipate. Allow at least three to four hours for it to cool and reset, then retest.

Fuse, circuit breaker, ground fault protective device, etc. has not tripped -

 <b>WARNING</b>
<p><b>HIGH VOLTAGE!</b>  <b>DISCONNECT ALL POWER BEFORE SERVICING OR INSTALLING. MULTIPLE POWER SOURCES MAY BE PRESENT. FAILURE TO DO SO MAY CAUSE PROPERTY DAMAGE, PERSONAL INJURY OR DEATH.</b></p> 

1. Remove the leads from the compressor terminals.

 <b>WARNING</b>
<p><b>SEE WARNINGS BEFORE REMOVING COMPRESSOR TERMINAL COVER.</b></p>

2. Using an ohmmeter, test continuity between terminals S-R, C-R, and C-S.

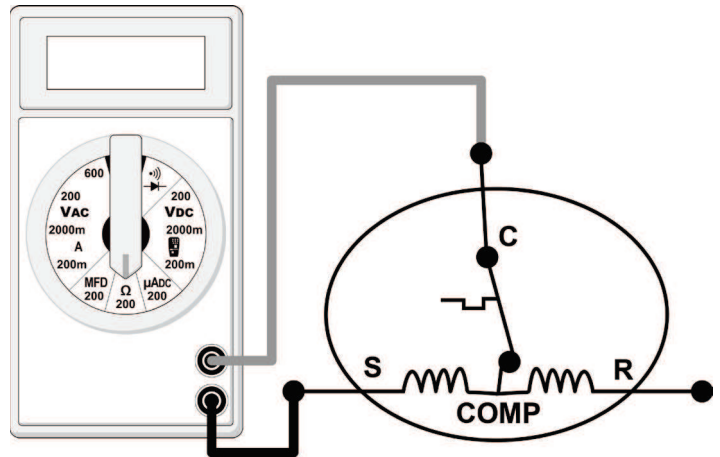

**TESTING COMPRESSOR WINDINGS**

If either winding does not test continuous, replace the compressor.

**NOTE: If an open compressor is indicated, allow ample time for the internal overload to reset before replacing compressor.**

## GROUND TEST

If fuse, circuit breaker, ground fault protective device, etc. has tripped, this is a strong indication that an electrical problem exists and must be found and corrected. The circuit protective device rating must be checked and its maximum rating should coincide with that marked on the equipment nameplate.

With the terminal protective cover in place, it is acceptable to replace the fuse or reset the circuit breaker **ONE TIME ONLY** to see if it was just a nuisance opening. If it opens again, **DO NOT** continue to reset.

**Disconnect all power to unit, making sure that all power legs are open.**

1. Carefully remove the compressor terminal protective cover and inspect for loose leads or insulation breaks in the lead wires.
2. Disconnect the three leads going to the compressor terminals at the compressor or nearest point to the compressor.
3. Check for a ground separately between each of the three terminals and ground (such as an unpainted tube on the compressor). If there is any reading of continuity to ground on the meter, the compressor should be considered defective.
4. If ground is indicated, replace the compressor.

 <b>WARNING</b>
<p><b>DAMAGE CAN OCCUR TO THE GLASS EMBEDDED TERMINALS IF THE LEADS ARE NOT PROPERLY REMOVED. THIS CAN RESULT IN TERMINAL AND HOT OIL DISCHARGING.</b></p>

# SERVICING

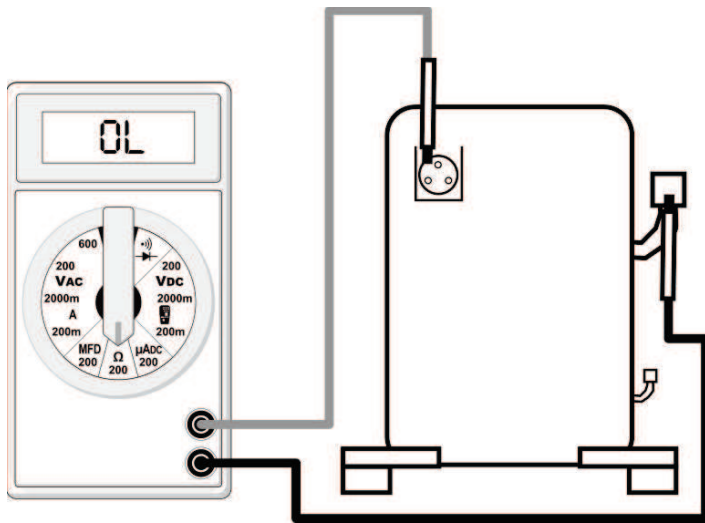

**COMPRESSOR GROUND TEST**

## UNLOADER TEST PROCEDURE (2 STAGE COMPRESSOR ONLY)

A nominal 24-volt direct current coil activates the compressor internal unloader solenoid. The input control circuit voltage must be 18 to 28 volt ac (remove). The coil power requirement is 5 VA. The external electrical connection is made with a molded plug assembly. This plug contains a full wave rectifier to supply direct current to the unloader coil. The measured DC voltage at the connectors in the plug should be 15 to 27 volt dc.

## UNLOADER TEST PROCEDURE



If it is suspected that the unloader is not working, the following methods may be used to verify operation.

1. Operate the system and measure compressor amperage. Cycle the unloader ON and OFF at 10 second intervals. The compressor amperage should increase when switching from part-load to full-load and decrease when switching from full-load to part-load. The percent change depends on the operating conditions and voltage, but should be at least 25 percent.
2. If step one does not give the expected results, shut unit off. Apply 18 to 28 volt ac to the unloader molded plug leads and listen for a click as the solenoid pulls in. Remove power and listen for another click as the unloader returns to its original position.
3. If clicks can't be heard, shut off power to the unit and remove the control circuit molded plug from the compressor and measure the unloader coil resistance (connections on the compressor). The solenoid coil should have continuity and not be grounded or have infinite resistance. If the coil resistance is infinite, zero, or grounded, the compressor must be replaced.
4. Next check the molded plug.

- a. Voltage check: Apply control voltage to the plug wires (18 to 28 volt ac). The measured dc voltage at the female connectors in the plug should be around 15 to 27 vdc.
- b. Resistance check: Measure the resistance from the end of one molded plug lead to either of the two female connectors in the plug. One of the connectors should read close to zero ohms while the other should read infinity. Repeat with other wire. The same female connector as before should read zero while the other connector again reads infinity. Reverse polarity on the ohmmeter leads and repeat. The female connector that read infinity previously should now read close to zero ohms.
- c. Replace plug if either of these test methods doesn't show the desired results.

## OPERATION TEST

If the voltage, capacitor, overload and motor winding test fail to show the cause for failure:

 <b>WARNING</b>
<p><b>HIGH VOLTAGE!</b> DISCONNECT ALL POWER BEFORE SERVICING OR INSTALLING. MULTIPLE POWER SOURCES MAY BE PRESENT. FAILURE TO DO SO MAY CAUSE PROPERTY DAMAGE, PERSONAL INJURY OR DEATH.</p>

1. Remove unit wiring from disconnect switch and wire a test cord to the disconnect switch.

**NOTE: The wire size of the test cord must equal the line wire size and the fuse must be of the proper size and type.**

2. With the protective terminal cover in place, use the three leads to the compressor terminals that were disconnected at the nearest point to the compressor and connect the common, start and run clips to the respective leads.
3. Connect good capacitors of the right MFD and voltage rating into the circuit as shown.
4. With power ON, close the switch.

 <b>WARNING</b>
<b>LINE VOLTAGE NOW PRESENT.</b>

- a. If the compressor starts and continues to run, the cause for failure is somewhere else in the system.
- b. If the compressor fails to start - replace.

# SERVICING

## LOCKED ROTOR TEST

If fuse, circuit breaker, ground fault protective device, etc. has tripped, this is a strong indication that an electrical problem exists and must be found and corrected. The circuit protective device rating must be checked and its maximum rating should coincide with that marked on the equipment nameplate.

Before checking for locked rotor, the compressor terminals should be checked for open windings (see Resistance Test) and the run capacitor and start capacitor (if used) should be checked thoroughly (see Checking Capacitor).

With power ON:

 <b>WARNING</b>
<b>LINE VOLTAGE NOW PRESENT.</b>

1. Check the serial data plate for the compressor locked rotor amps (LRA) rating.
2. Using an ammeter, measure the amperage reading for the run and common wires to the compressor. Since the compressor motor overload will likely trip soon after drawing locked rotor amps, this measurement should be taken as soon as the compressor starts.
3. If the amperage reading roughly equals the compressor LRA rating and all other checks have been completed, locked rotor amps has been verified.

## TESTING CRANKCASE HEATER (OPTIONAL ITEM)

The crankcase heater must be energized a minimum of four (4) hours before the condensing unit is operated.

Crankcase heaters are used to prevent migration or accumulation of refrigerant in the compressor crankcase during the off cycles and prevents liquid slugging or oil pumping on start up.

A crankcase heater will not prevent compressor damage due to a floodback or over charge condition.

 <b>WARNING</b>
<b>DISCONNECT ALL POWER BEFORE SERVICING.</b>

1. Disconnect the heater lead in wires.
2. Using an ohmmeter, check heater continuity - should test continuous. If not, replace.

## REFRIGERATION REPAIR PRACTICE

 <b>DANGER</b>
<b>ALWAYS REMOVE THE REFRIGERANT CHARGE IN A PROPER MANNER BEFORE APPLYING HEAT TO THE SYSTEM.</b>

When repairing the refrigeration system:

 <b>WARNING</b>
<b>DISCONNECT ALL POWER BEFORE SERVICING.</b>

1. Never open a system that is under vacuum. Air and moisture will be drawn in.
2. Plug or cap all openings.
3. Remove all burrs and clean the brazing surfaces of the tubing with sand cloth or paper. Brazing materials do not flow well on oxidized or oily surfaces.
4. Clean the inside of all new tubing to remove oils and pipe chips.
5. When brazing, sweep the tubing with dry nitrogen to prevent the formation of oxides on the inside surfaces.
6. Complete any repair by replacing the liquid line drier in the system, evacuate and charge.

## BRAZING MATERIALS

**Copper to Copper Joints** - Sil-Fos used without flux (alloy of 15% silver, 80% copper, and 5% phosphorous). Recommended heat 1400°F.

**Copper to Steel Joints** - Silver Solder used without a flux (alloy of 30% silver, 38% copper, 32% zinc). Recommended heat - 1200°F.

**Aluminum to Aluminum & Copper to Aluminum Joints** - ZA-1 Brazing Rods use Flux System Cesium-Based Polymer System (alloy of 78% Zinc and 22% Aluminum). Melting point 826°F Flow point 905°F.

## STANDING PRESSURE TEST (RECOMMENDED BEFORE SYSTEM EVACUATION)

 <b>WARNING</b>
<b>TO AVOID THE RISK OF FIRE OR EXPLOSION, NEVER USE OXYGEN, HIGH PRESSURE AIR OR FLAMMABLE GASES FOR LEAK TESTING OF A REFRIGERATION SYSTEM.</b>

 <b>WARNING</b>
<b>TO AVOID POSSIBLE EXPLOSION, THE LINE FROM THE NITROGEN CYLINDER MUST INCLUDE A PRESSURE REGULATOR AND A PRESSURE RELIEF VALVE. THE PRESSURE RELIEF VALVE MUST BE SET TO OPEN AT NO MORE THAN 450 PSIG.</b>

# SERVICING

Using dry nitrogen, pressurize the system to 450 PSIG. Allow the pressure to stabilize and hold for 15 minutes (minimum). If the pressure does not drop below 450 PSIG, the system is considered leak free. Proceed to system evacuation using the Deep Vacuum Method. If after 15 minutes the pressure drops below 450 PSIG, follow the procedure outlined below to identify system leaks. Repeat the Standing Pressure Test.

## LEAK TESTING (NITROGEN OR NITROGEN-TRACED)



### WARNING

TO AVOID THE RISK OF FIRE OR EXPLOSION, NEVER USE OXYGEN, HIGH PRESSURE AIR OR FLAMMABLE GASES FOR LEAK TESTING OF A REFRIGERATION SYSTEM.



### WARNING

TO AVOID POSSIBLE EXPLOSION, THE LINE FROM THE NITROGEN CYLINDER MUST INCLUDE A PRESSURE REGULATOR AND A PRESSURE RELIEF VALVE. THE PRESSURE RELIEF VALVE MUST BE SET TO OPEN AT NO MORE THAN 450 PSIG.

Leak test the system using dry nitrogen and soapy water to identify leaks. If you prefer to use an electronic leak detector, charge the system to 10 PSIG with the appropriate system refrigerant (See Serial Data Plate for refrigerant identification). Using dry nitrogen, finish charging the system to 450 PSIG. Apply the leak detector to all suspect areas. When leaks are discovered, repair the leaks, and repeat the pressure test. If leaks have been eliminated proceed to system evacuation.

## SYSTEM EVACUATION

Condensing unit liquid and suction valves are closed to contain the charge within the unit. The unit is shipped with the valve stems closed and caps installed. Do not open valves until the system is evacuated.



### WARNING

REFRIGERANT UNDER PRESSURE!  
FAILURE TO FOLLOW PROPER PROCEDURES MAY CAUSE PROPERTY DAMAGE, PERSONAL INJURY OR DEATH.

**NOTE:** Scroll compressors should never be used to evacuate or pump down a heat pump or air conditioning system.



### CAUTION

PROLONGED OPERATION AT SUCTION PRESSURES LESS THAN 20 PSIG FOR MORE THAN 5 SECONDS WILL RESULT IN OVERHEATING OF THE SCROLLS AND PERMANENT DAMAGE TO THE SCROLL TIPS, DRIVE BEARINGS AND INTERNAL SEAL.

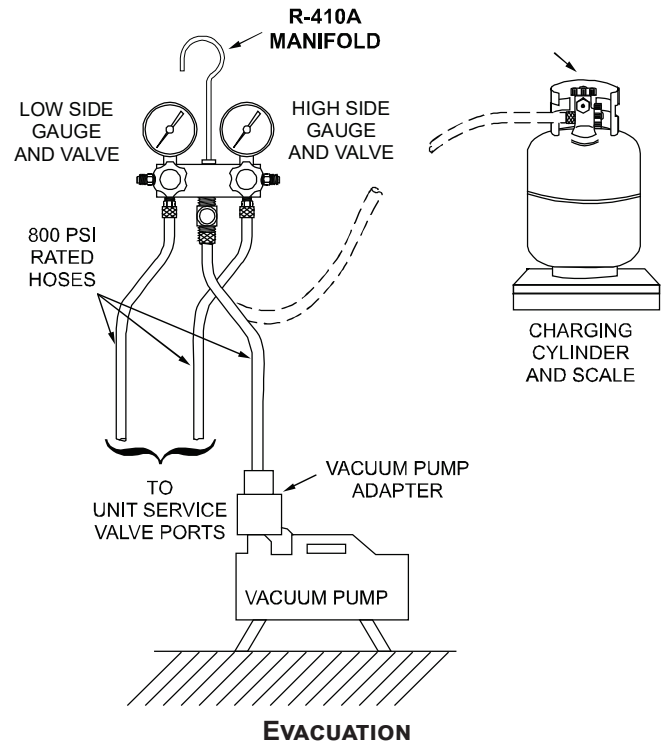

## DEEP VACUUM METHOD (RECOMMENDED)

The Deep Vacuum Method requires a vacuum pump rated for 500 microns or less. This method is an effective and efficient way of assuring the system is free of non-condensable air and moisture. As an alternative, the Triple Evacuation Method is detailed in the Service Manual for this product model.

It is recommended to remove the Schrader Cores from the service valves using a core-removal tool to expedite the evacuation procedure.

1. Connect the vacuum pump, micron gauge, and vacuum rated hoses to both service valves. Evacuation must use both service valves to eliminate system mechanical seals.
2. Evacuate the system to less than 500 microns.
3. Isolate the pump from the system and hold vacuum for 10 minutes (minimum). Typically, pressure will rise slowly during this period. If the pressure rises to less than 1000 microns and remains steady, the system is considered leak-free; proceed to system charging and startup.
4. If pressure rises above 1000 microns but holds steady below 2000 microns, non-condensable air or moisture may remain or small leak is present. Return to step 2: If the same result is achieved, check for leaks and repair. Repeat the evacuation procedure.

# SERVICING

- If pressure rises above 2000 microns, a leak is present. Check for leaks and repair. Repeat the evacuation procedure.

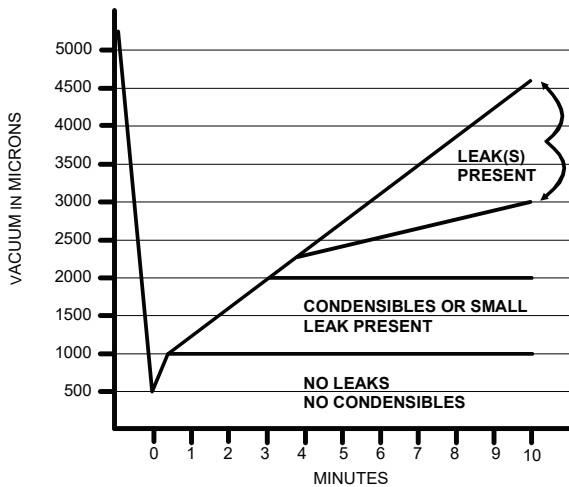

## TRIPLE EVACUATION METHOD (ALTERNATE)

- Evacuate the system to 4000 microns and hold for 15 minutes. Break the vacuum with dry nitrogen, bring the system pressure to 2-3 PSIG, and hold for 20 minutes. Release the nitrogen,
- Evacuate to 1500 microns and hold for 20 minutes. Break the vacuum with dry nitrogen again, bring the system pressure back to 2-3 PSIG, and hold for 20 minutes.
- Evacuate the system to 500 microns and hold for 60 minutes.
- If the pressure rises to 1000 microns or less and remains steady the system is considered leak free; proceed to start-up.

## CHARGING



### WARNING

#### REFRIGERANT UNDER PRESSURE!

- Do NOT OVERCHARGE SYSTEM WITH REFRIGERANT.
- Do NOT OPERATE UNIT IN A VACUUM OR AT NEGATIVE PRESSURE.

FAILURE TO FOLLOW PROPER PROCEDURES MAY CAUSE PROPERTY DAMAGE, PERSONAL INJURY OR DEATH.



### CAUTION

ONLY USE REFRIGERANT CERTIFIED TO AHRI STANDARDS. USED REFRIGERANT MAY CAUSE COMPRESSOR DAMAGE. THE MANUFACTURER IS NOT RESPONSIBLE FOR DAMAGE OR THE NEED FOR REPAIRS RESULTING FROM THE USE OF UNAPPROVED REFRIGERANT TYPES OR USED OR RECYCLED REFRIGERANT. MOST PORTABLE MACHINES CANNOT CLEAN USED REFRIGERANT TO MEET AHRI STANDARDS.



### CAUTION

OPERATING THE COMPRESSOR WITH THE SUCTION VALVE CLOSED WILL CAUSE SERIOUS COMPRESSOR DAMAGE.

Charge the system with the exact amount of refrigerant.

See the unit nameplate for the correct refrigerant charge amount.

**An inaccurately charged system will cause future problems.**

- Using a charging scale, weigh in the refrigerant charge amount listed on unit nameplate. Allow liquid refrigerant only to enter the high side.
- After the system will take all it will take, close the valve on the high side of the charging manifold.
- Start the system and charge the balance of the refrigerant through the low side.

**NOTE: R410A should be drawn out of the storage container or drum in liquid form due to its fractionation properties, but should be "Flashed" to its gas state before entering the system. There are commercially available restriction devices that fit into the system charging hose set to accomplish this. DO NOT charge liquid R410A into the compressor.**

- With the system still running, close the valve on the charging cylinder. At this time, you may still have some liquid refrigerant in the charging cylinder hose and will definitely have liquid in the liquid hose. Reseat the liquid line core. Slowly open the high side manifold valve and transfer the liquid refrigerant from the liquid line hose and charging cylinder hose into the suction service valve port. CAREFUL: Watch so that liquid refrigerant does not enter the compressor.

Due to their design, Scroll compressors are inherently more tolerant of liquid refrigerant.

### REFRIGERANT CHARGE CHECK (UNITS WITH FIXED ORIFICE DEVICES)

After completing airflow measurements and adjustments the unit's refrigerant charge must be checked. All package units with fixed orifice devices are charged using the super heat method at the compressor suction line.

After superheat is adjusted it is recommended to check unit subcooling at the condenser coil liquid line out.



# SERVICING

## SUPERHEAT

Before checking the superheat or replacing the valve, perform all the procedures outlined under Air Flow, Refrigerant Charge, Expansion Valve - Overfeeding, Underfeeding. These are the most common causes for evaporator malfunction.

### CHECKING SUPERHEAT

Refrigerant gas is considered superheated when its temperature is higher than the saturation temperature corresponding to its pressure. The degree of superheat equals the degrees of temperature increase above the saturation temperature at existing pressure.

Procedure:

1. Run system at least 15-20 minutes to allow pressure to stabilize.
2. Install a low side pressure gauge on the suction line access fitting.
3. Temporarily install thermometer on suction (large) line near compressor with adequate contact and insulate for best possible reading.
4. Record the gauge pressure corresponding temperature and the temperature of the suction line.
5. Refer to the superheat table for proper system superheat. Add charge to lower superheat recover charge to raise superheat.

Ambient Condenser Inlet Temp (°F Drybulb)	Return Air Temp. (°F Drybulb)				
	65	70	75	80	85
100	-	-	-	10	10
95	-	-	10	10	10
90	-	-	12	15	18
85	-	10	13	17	20
80	-	10	15	21	26
75	10	13	17	25	29
70	10	17	20	28	32
65	13	19	26	32	35
60	17	25	30	33	37

**SUPERHEAT TABLE**

### EXAMPLE:

- a. Suction Pressure = 143
- b. Corresponding Temp. °F. = 50
- c. Thermometer on Suction Line = 59°F

To obtain the degrees temperature of superheat, subtract 50.0 from 59.0°F. The difference is 9° Superheat. The 9° Superheat would fall in the ± range of allowable superheat.

**SUPERHEAT = SUCTION LINE TEMP - SAT. SUCTION TEMP.**

### (UNITS WITH TXV DEVICES)

All package units with TXV devices are charged using the SUBCOOLING method at the liquid line. After subcooling is checked it is recommended to check unit superheat at the evaporator coil suction line.

### CHECKING SUBCOOLING

Refrigerant liquid is considered subcooled when its temperature is lower than the saturation temperature corresponding to its pressure. The degree of subcooling equals the degrees of temperature decrease below the saturation temperature at the existing pressure.

Procedure:

1. Attach an accurate thermometer or preferably a thermocouple type temperature tester to the liquid line close to the pressure switch.
2. Install a high side pressure gauge on the liquid access fitting.
3. Record the gauge pressure and the temperature of the line.
4. The difference between the thermometer reading and pressure to temperature conversion is the amount of subcooling.

**SUBCOOLING FORMULA = SAT. LIQUID TEMP. - LIQUID LINE TEMP.**

### EXAMPLE:

- a. Liquid Line Pressure = 417
- b. Corresponding Temp. °F. = 120°
- c. Thermometer on Liquid line = 109°F.

To obtain the amount of subcooling, subtract 109°F from 120°F. The difference is 11° subcooling. See the specification sheet or technical information manual for the design subcooling range for your unit.

See R410A Pressure vs. Temperature chart.

### EXPANSION VALVE (TXV) SYSTEM TWO SPEED APPLICATION (\*PGM5)

Run the unit on high stage cooling for 15-20 minutes until refrigerant pressures stabilize. Check charge with unit on high stage.

Follow checking subcooling instructions

**NOTE: The TXV provided is designed to meet the specification requirements for optimum product operation. "NO ADJUSTMENTS NEEDED TO TXV".**

**NOTE: Even though the compressor section of a scroll compressor is more tolerant of liquid refrigerant, continued floodback or flooded start conditions may wash oil from the bearing surfaces causing premature bearing failure.**



# SERVICING

## CHECKING COMPRESSOR EFFICIENCY

The reason for compressor inefficiency is broken or damaged scroll flanks on Scroll compressors, reducing the ability of the compressor to pump refrigerant vapor.

The condition of the scroll flanks is checked in the following manner.

1. Attach gauges to the high and low side of the system.
2. Start the system and run a "Cooling Performance Test."

If the test shows:

- a. Below normal high side pressure.
- b. Above normal low side pressure.
- c. Low temperature difference across coil.
- d. Low amp draw at compressor.

And the charge is correct. The compressor is faulty - replace the compressor.

## THERMOSTATIC EXPANSION VALVE

The expansion valve is designed to control the rate of liquid refrigerant flow into an evaporator coil in exact proportion to the rate of evaporation of the refrigerant in the coil. The amount of refrigerant entering the coil is regulated since the valve responds to temperature of the refrigerant gas leaving the coil (feeler bulb contact) and the pressure of the refrigerant in the coil.

This regulation of the flow prevents the return of liquid refrigerant to the compressor.

The three forces which govern the operation of the valve are: (1) the pressure created in the power assembly by the feeler bulb, (2) evaporator pressure, and (3) the equivalent pressure of the superheat spring in the valve.

0% bleed type expansion valves are used on the indoor coils. The 0% valve will not allow the system pressures (High and Low side) to equalize during the shut down period. The valve will shut off completely at approximately 100 PSIG Pressure.

Good thermal contact between the feeler bulb and the suction line is essential to satisfactory valve control and performance.

The bulb must be securely fastened to a clean straight section of the suction line. Application of the bulb to a horizontal run of line is preferred. If a vertical installation cannot be avoided the bulb should be mounted so that the capillary tubing comes out at the top.

THE VALVES PROVIDED ARE DESIGNED TO MEET THE SPECIFICATION REQUIREMENTS FOR OPTIMUM PRODUCT OPERATION. **DO NOT USE SUBSTITUTES.**

## OVERFEEDING

Overfeeding by the expansion valve results in high suction pressure, cold suction line, and possible liquid slugging of the compressor.

If these symptoms are observed:

1. Check for an overcharged unit by referring to the cooling performance charts in the servicing section.
2. Check the operation of the power element in the valve as explained in Checking Expansion Valve Operation.
3. Check for restricted or plugged equalizer tube.

## UNDERFEEDING

Underfeeding by the expansion valve results in low system capacity and low suction pressures.

If these symptoms are observed:

1. Check for a restricted liquid line or drier. A restriction will be indicated by a temperature drop across the drier.
2. Check the operation of the power element of the valve as described in Checking Expansion Valve Operation.



## CAUTION

**TO PREVENT PERSONAL INJURY, CAREFULLY CONNECT AND DISCONNECT MANIFOLD GAUGE HOSES. ESCAPING LIQUID REFRIGERANT CAN CAUSE BURNS. DO NOT VENT REFRIGERANT TO ATMOSPHERE. RECOVER DURING SYSTEM REPAIR OR FINAL UNIT DISPOSAL.**

# SERVICING

Pressure vs. Temperature Chart											
R-410A											
PSIG	°F	PSIG	°F	PSIG	°F	PSIG	°F	PSIG	°F	PSIG	°F
12	-37.7	114.0	37.8	216.0	74.3	318.0	100.2	420.0	120.7	522.0	137.6
14	-34.7	116.0	38.7	218.0	74.9	320.0	100.7	422.0	121.0	524.0	137.9
16	-32.0	118.0	39.5	220.0	75.5	322.0	101.1	424.0	121.4	526.0	138.3
18	-29.4	120.0	40.5	222.0	76.1	324.0	101.6	426.0	121.7	528.0	138.6
20	-36.9	122.0	41.3	224.0	76.7	326.0	102.0	428.0	122.1	530.0	138.9
22	-24.5	124.0	42.2	226.0	77.2	328.0	102.4	430.0	122.5	532.0	139.2
24	-22.2	126.0	43.0	228.0	77.8	330.0	102.9	432.0	122.8	534.0	139.5
26	-20.0	128.0	43.8	230.0	78.4	332.0	103.3	434.0	123.2	536.0	139.8
28	-17.9	130.0	44.7	232.0	78.9	334.0	103.7	436.0	123.5	538.0	140.1
30	-15.8	132.0	45.5	234.0	79.5	336.0	104.2	438.0	123.9	540.0	140.4
32	-13.8	134.0	46.3	236.0	80.0	338.0	104.6	440.0	124.2	544.0	141.0
34	-11.9	136.0	47.1	238.0	80.6	340.0	105.1	442.0	124.6	548.0	141.6
36	-10.1	138.0	47.9	240.0	81.1	342.0	105.4	444.0	124.9	552.0	142.1
38	-8.3	140.0	48.7	242.0	81.6	344.0	105.8	446.0	125.3	556.0	142.7
40	-6.5	142.0	49.5	244.0	82.2	346.0	106.3	448.0	125.6	560.0	143.3
42	-4.5	144.0	50.3	246.0	82.7	348.0	106.6	450.0	126.0	564.0	143.9
44	-3.2	146.0	51.1	248.0	83.3	350.0	107.1	452.0	126.3	568.0	144.5
46	-1.6	148.0	51.8	250.0	83.8	352.0	107.5	454.0	126.6	572.0	145.0
48	0.0	150.0	52.5	252.0	84.3	354.0	107.9	456.0	127.0	576.0	145.6
50	1.5	152.0	53.3	254.0	84.8	356.0	108.3	458.0	127.3	580.0	146.2
52	3.0	154.0	54.0	256.0	85.4	358.0	108.8	460.0	127.7	584.0	146.7
54	4.5	156.0	54.8	258.0	85.9	360.0	109.2	462.0	128.0	588.0	147.3
56	5.9	158.0	55.5	260.0	86.4	362.0	109.6	464.0	128.3	592.0	147.9
58	7.3	160.0	56.2	262.0	86.9	364.0	110.0	466.0	128.7	596.0	148.4
60	8.6	162.0	57.0	264.0	87.4	366.0	110.4	468.0	129.0	600.0	149.0
62	10.0	164.0	57.7	266.0	87.9	368.0	110.8	470.0	129.3	604.0	149.5
64	11.3	166.0	58.4	268.0	88.4	370.0	111.2	472.0	129.7	608.0	150.1
66	12.6	168.0	59.0	270.0	88.9	372.0	111.6	474.0	130.0	612.0	150.6
68	13.8	170.0	59.8	272.0	89.4	374.0	112.0	476.0	130.3	616.0	151.2
70	15.1	172.0	60.5	274.0	89.9	376.0	112.4	478.0	130.7	620.0	151.7
72	16.3	174.0	61.1	276.0	90.4	378.0	112.6	480.0	131.0	624.0	152.3
74	17.5	176.0	61.8	278.0	90.9	380.0	113.1	482.0	131.3	628.0	152.8
76	18.7	178.0	62.5	280.0	91.4	382.0	113.5	484.0	131.6	632.0	153.4
78	19.8	180.0	63.1	282.0	91.9	384.0	113.9	486.0	132.0	636.0	153.9
80	21.0	182.0	63.8	284.0	92.4	386.0	114.3	488.0	132.3	640.0	154.5
82	22.1	184.0	64.5	286.0	92.8	388.0	114.7	490.0	132.6	644.0	155.0
84	23.2	186.0	65.1	288.0	93.3	390.0	115.0	492.0	132.9	648.0	155.5
86	24.3	188.0	65.8	290.0	93.8	392.0	115.5	494.0	133.3	652.0	156.1
88	25.4	190.0	66.4	292.0	94.3	394.0	115.8	496.0	133.6	656.0	156.6
90	26.4	192.0	67.0	294.0	94.8	396.0	116.2	498.0	133.9	660.0	157.1
92	27.4	194.0	67.7	296.0	95.2	398.0	116.6	500.0	134.0	664.0	157.7
94	28.5	196.0	68.3	298.0	95.7	400.0	117.0	502.0	134.5	668.0	158.2
96	29.5	198.0	68.9	300.0	96.2	402.0	117.3	504.0	134.8	672.0	158.7
98	30.5	200.0	69.5	302.0	96.6	404.0	117.7	506.0	135.2	676.0	159.2
100	31.2	202.0	70.1	304.0	97.1	406.0	118.1	508.0	135.5	680.0	159.8
102	32.2	204.0	70.7	306.0	97.5	408.0	118.5	510.0	135.8	684.0	160.3
104	33.2	206.0	71.4	308.0	98.0	410.0	118.8	512.0	136.1	688.0	160.8
106	34.1	208.0	72.0	310.0	98.4	412.0	119.2	514.0	136.4	692.0	161.3
108	35.1	210.0	72.6	312.0	98.9	414.0	119.6	516.0	136.7	696.0	161.8
110	35.5	212.0	73.2	314.0	99.3	416.0	119.9	518.0	137.0		
112	36.9	214.0	73.8	316.0	99.7	418.0	120.3	520.0	137.3		

\*Based on ALLIED SIGNAL Data

# SERVICING

REQUIRED LIQUID LINE TEMPERATURE						
LIQUID PRESSURE AT SERVICE VALVE (PSIG)	REQUIRED SUBCOOLING TEMPERATURE (°F)					
	8	10	12	14	16	18
189	58	56	54	52	50	48
195	60	58	56	54	52	50
202	62	60	58	56	54	52
208	64	62	60	58	56	54
215	66	64	62	60	58	56
222	68	66	64	62	60	58
229	70	68	66	64	62	60
236	72	70	68	66	64	62
243	74	72	70	68	66	64
251	76	74	72	70	68	66
259	78	76	74	72	70	68
266	80	78	76	74	72	70
274	82	80	78	76	74	72
283	84	82	80	78	76	74
291	86	84	82	80	78	76
299	88	86	84	82	80	78
308	90	88	86	84	82	80
317	92	90	88	86	84	82
326	94	92	90	88	86	84
335	96	94	92	90	88	86
345	98	96	94	92	90	88
354	100	98	96	94	92	90
364	102	100	98	96	94	92
374	104	102	100	98	96	94
384	106	104	102	100	98	96
395	108	106	104	102	100	98
406	110	108	106	104	102	100
416	112	110	108	106	104	102
427	114	112	110	108	106	104
439	116	114	112	110	108	106
450	118	116	114	112	110	108
462	120	118	116	114	112	110
474	122	120	118	116	114	112
486	124	122	120	118	116	114
499	126	124	122	120	118	116
511	128	126	124	122	120	118

# SERVICING

## CHECKING EXPANSION VALVE OPERATION

1. Remove the remote bulb of the expansion valve from the suction line.
2. Start the system and cool the bulb in a container of ice water, closing the valve. As you cool the bulb, the suction pressure should fall and the suction temperature will rise.
3. Next warm the bulb in your hand. As you warm the bulb, the suction pressure should rise and the suction temperature will fall.
4. If a temperature or pressure change is noticed, the expansion valve is operating. If no change is noticed, the valve is restricted, the power element is faulty, or the equalizer tube is plugged.
5. Capture the charge, replace the valve and drier and evacuate.

## FIXED ORIFICE RESTRICTOR DEVICES

The fixed orifice restrictor device (flowrator) used in conjunction with the indoor coil is a predetermined bore (I.D.).

It is designed to control the rate of liquid refrigerant flow into an evaporator coil.

The amount of refrigerant that flows through the fixed orifice restrictor device is regulated by the pressure difference between the high and low sides of the system.

In the cooling cycle when the outdoor air temperature rises, the high side condensing pressure rises. At the same time, the cooling load on the indoor coil increases, causing the low side pressure to rise, but at a slower rate.

Since the high side pressure rises faster when the temperature increases, more refrigerant flows to the evaporator, increasing the cooling capacity of the system.

When the outdoor temperature falls, the reverse takes place. The condensing pressure falls, and the cooling loads on the indoor coil decreases, causing less refrigerant flow.

A strainer is placed on the entering side of the tube to prevent any foreign material from becoming lodged inside the fixed orifice restriction device.

If a restriction should become evident, proceed as follows:

1. Recover refrigerant charge.
2. Remove the orifice or tube strainer assembly and replace.
3. Replace liquid line drier, evacuate and recharge.

## CHECKING EQUALIZATION TIME

During the "OFF" cycle, the high side pressure bleeds to the low side through the fixed orifice restriction device. Check equalization time as follows:

1. Attach a gauge manifold to the suction and liquid line dill valves.
2. Start the system and allow the pressures to stabilize.
3. Stop the system and check the time it takes for the high and low pressure gauge readings to equalize.

If it takes more than seven (7) minutes to equalize, the restrictor device is inoperative. Replace, install a liquid line drier, evacuate and recharge.

## CHECKING RESTRICTED LIQUID LINE

When the system is operating, the liquid line is warm to the touch. If the liquid line is restricted, a definite temperature drop will be noticed at the point of restriction. In severe cases, frost will form at the restriction and extend down the line in the direction of the flow.

Discharge and suction pressures will be low, giving the appearance of an undercharged unit. However, the unit will have normal to high subcooling.

Locate the restriction, replace the restricted part, replace drier, evacuate and recharge.

## OVERCHARGE OF REFRIGERANT

An overcharge of refrigerant is normally indicated by an excessively high head pressure.

An evaporator coil, using an TXV expansion valve metering device, will basically modulate and control a flooded evaporator and prevent liquid refrigerant return to the compressor.

An evaporator coil, using a fixed orifice restrictor device (flowrator) metering device, could allow liquid refrigerant to return to the compressor under extreme overcharge conditions.

Also with a fixed orifice restrictor device (flowrator) metering device, extreme cases of insufficient indoor air can cause icing of the indoor coil and liquid refrigerant return to the compressor, but the head pressure would be lower.

There are other causes for high head pressure.

If other causes check out normal, an overcharge or a system containing non-condensables would be indicated.

If this is observed:

1. Start the system.
2. Remove and capture small quantities of refrigerant as from the suction line access fitting until the head pressure is reduced to normal.
3. Observe the system while running a cooling performance test. If a shortage of refrigerant is indicated, then the system contains non-condensables.

# SERVICING

## NON-CONDENSABLES

If non-condensables are suspected, shut down the system and allow the pressures to equalize. Wait at least 15 minutes. Compare the pressure to the temperature of the coldest coil since this is where most of the refrigerant will be. If the pressure indicates a higher temperature than that of the coil temperature, non-condensables are present. Non-condensables are removed from the system by first removing the refrigerant charge, replacing and/or installing liquid line drier, evacuating and recharging.

Air Conditioning Diagnostic Chart					
Issue	Discharge Pressure	Suction Pressure	(Orifice) Superheat	(TXV) Subcooling	Temperature Split
Liquid Line Restriction	↓	↓	↑	↑	↓
System Undercharge	↓	↓	↑	↓	↓
System Overcharge	↑	↑	↓	↑	↓
Non Condensable	↑	↑	↑	↑	↓
Low Indoor Airflow	↓	↓	↓	↑	↑
Inefficient Compressor	↓	↑	↑	↓	↓

## COMPRESSOR BURNOUT

When a compressor burns out, high temperature develops causing the refrigerant, oil and motor insulation to decompose forming acids and sludge.

If a compressor is suspected of being burned-out, attach a refrigerant hose to the liquid line dill valve and properly remove and dispose of the refrigerant.

 <b>NOTICE</b>
<b>VIOLATION OF EPA REGULATIONS MAY RESULT IN FINES OR OTHER PENALTIES.</b>

Now determine if a burn out has actually occurred. Confirm by analyzing an oil sample using a Sporlan Acid Test Kit, AK-3 or its equivalent.

Remove the compressor and obtain an oil sample from the suction stub. If the oil is not acidic, either a burnout has not occurred or the burnout is so mild that a complete clean-up is not necessary.

If acid level is unacceptable, the system must be cleaned by using the clean-up drier method.

 <b>CAUTION</b>
<b>DO NOT ALLOW THE SLUDGE OR OIL TO CONTACT THE SKIN. SEVERE BURNS MAY RESULT.</b>

**NOTE: The Flushing Method using R-11 refrigerant is no longer approved by Amana® Brand Heating-Cooling.**

## SUCTION LINE DRIER CLEAN-UP METHOD

The POE oils used with R410A refrigerant is an excellent solvent. In the case of a burnout, the POE oils will remove any burnout residue left in the system. If not captured by the refrigerant filter, they will collect in the compressor or other system components, causing a failure of the replacement compressor and/or spread contaminants throughout the system, damaging additional components.

The suction line filter drier should be installed as close to the compressor suction fitting as possible. The filter must be accessible and be rechecked for a pressure drop after the system has operated for a time. It may be necessary to use new tubing and form as required.

**NOTE: At least twelve (12) inches of the suction line immediately out of the compressor stub must be discarded due to burned residue and contaminates.**

1. Remove compressor discharge line strainer.
2. Remove the liquid line drier and expansion valve.
3. Purge all remaining components with dry nitrogen or carbon dioxide until clean.
4. Install new components including liquid line drier.
5. Braze all joints, leak test, evacuate, and recharge system.
6. Start up the unit and record the pressure drop across the drier.
7. Continue to run the system for a minimum of twelve (12) hours and recheck the pressure drop across the drier. Pressure drop should not exceed 6 PSIG.
8. Continue to run the system for several days, repeatedly checking pressure drop across the suction line drier. If the pressure drop never exceeds the 6 PSIG, the drier has trapped the contaminants. Remove the suction line drier from the system.
9. If the pressure drop becomes greater, then it must be replaced and steps 5 through 9 repeated until it does not exceed 6 PSIG.

**NOTICE: Regardless, the cause for burnout must be determined and corrected before the new compressor is started.**

## CHECKING EXTERNAL STATIC PRESSURE

The minimum and maximum allowable duct static pressure is found in the Technical Information Manual.

Too great of an external static pressure will result in insufficient air that can cause icing of the coil, whereas too much air can cause poor humidity control, and condensate to be pulled off the evaporator coil causing condensate leakage. Too much air can cause motor overloading and in many cases this constitutes a poorly designed system. To determine proper air movement, proceed as follows:



# SERVICING

- Using a digital manometer measure the static pressure of the return duct at the inlet of the unit, (Negative Pressure).

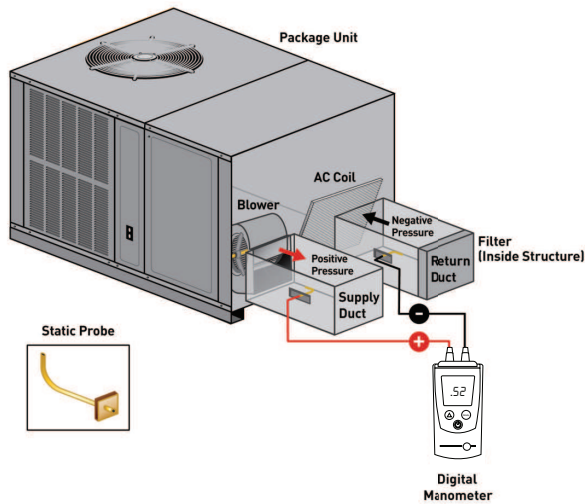

## TOTAL EXTERNAL STATIC

- Measure the static pressure of the supply duct, (Positive Pressure).
- Add the two readings together.

**NOTE: Both readings may be taken simultaneously and read directly on the manometer if so desired.**

- Consult proper table for quantity of air.

If the external static pressure exceeds the minimum or maximum allowable statics, check for closed dampers, dirty filters, undersized or poorly laid out ductwork.

## ADJUSTING AIRFLOW

\*PGM3 models are equipped with EEM motors. This motor is energized by 24V. Adjust the CFM for the unit by changing the 24V low voltage leads to the speed terminal block on the motor.

**NOTE: Heating airflow must be adjusted to provide the temperature rise shown on rating plate.**

Heating-White Lead      Cooling-Yellow Lead  
 T1 - Low Speed          T4 - Low Speed  
 T2 - Medium Speed      T5 - High Speed  
 T3 - High Speed

HEATING			COOLING		
Speed Tap	Definition	Lead Color	Speed Tap	Definition	Lead Color
T1	Low Speed Heat	White	T3	Low Speed Cool	Purple
T2	High Speed Heat	Brown	T4	High Speed Cool	Yellow
			T5	High Speed Cool Hi-Static	

The APM5[24-48] models are equipped with ECM circulating blower motors. The blower speed is adjusted using the DIP switches on the ECM interface module (located in the blower compartment (See Blower Performance section for settings)).

Electric Heat DIP Switch Settings		
Speed Tap	Switch 1	Switch 2
A	OFF	OFF
B	ON	OFF
C	OFF	ON
D	ON	ON

DIP Switch Settings for Single & Two-Stage Thermostat		
Thermostat	Switch 3	Switch 4
Single-Stage	N/A	ON
Two-Stage	N/A	OFF

Cooling/HP DIP Switch Settings		
Speed Tap	Switch 5	Switch 6
A	OFF	OFF
B	ON	OFF
C	OFF	ON
D	ON	ON

Speed Tap Adjustment Through DIP Switches		
CFM	Switch 7	Switch 8
Plus 10%	ON	OFF
Normal	OFF	OFF
Minus 10%	OFF	ON



# SERVICING

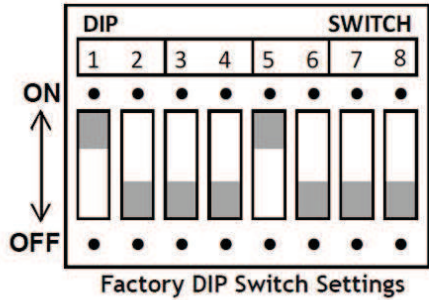

Switches	Function
1, 2	Electric Heat
3	N/A
4	Indoor Thermostat
5, 6	Cooling & Heat Pump CFM
7, 8	CFM Trim Adjust

DIP Switch Functions

## CHECKING TEMPERATURE RISE

Temperature rise is related to the BTUH output of the unit and the amount of air (CFM) circulated over the heat exchanger.

All units are designed for a given range of temperature increase. This is the temperature of the air leaving the unit minus the temperature of the air entering the unit.

The more air (CFM) being delivered through a given unit the less the rise will be; so the less air (CFM) being delivered, the greater the rise. The temperature rise should be adjusted in accordance to a given unit specifications and its external static pressure.

1. Check BTUH input to unit do not exceed input rating stamped on rating plate.
2. Take entering and leaving air temperatures.
3. Select the proper speed tap or dip switch setting for direct drive units.
4. Take motor amperage draw to determine that the motor is not overloaded during adjustments.

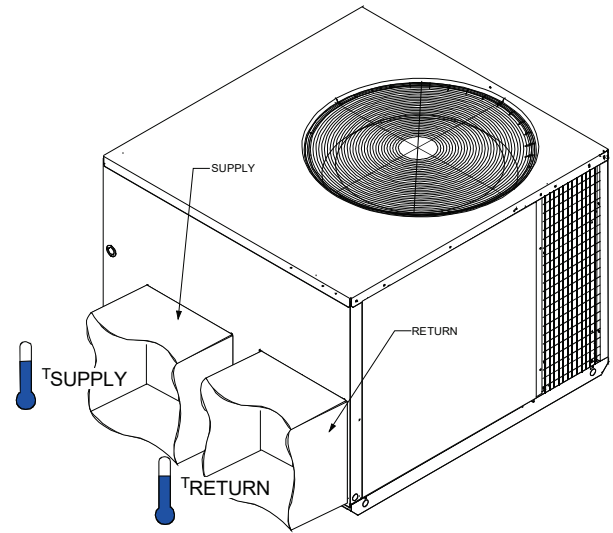

$$\text{RISE} = T_{\text{SUPPLY}} - T_{\text{RETURN}}$$

## CHECKING TEMPERATURE RISE

### TESTING PRIMARY LIMIT CONTROL

APG/GPG units use a snap-disk type primary limit device. Sometimes referred to as "stat on a stick". The limit setting is fixed and must not be readjusted in the field.

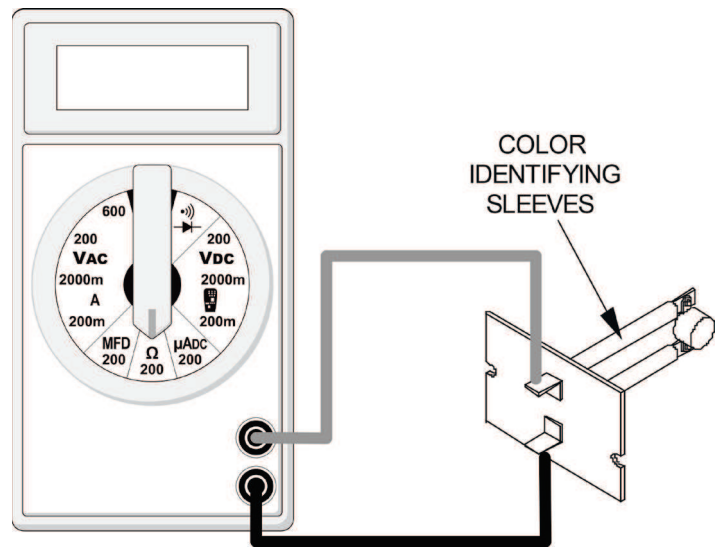

### TESTING PRIMARY LIMIT CONTROL

Refer to the specification section to determine the proper limit cutout temperature for the model being serviced.

In all instances the limit control is wired in series with the ignition control.

If the temperature within the furnace should exceed this setting, the control will open, de-energizing the ignition control which in turn will open the electrical circuit to the gas valve.

The control will automatically reset when the temperature within the combustion chamber is sufficiently lowered.

# SERVICING

**WARNING**

**HIGH VOLTAGE!**  
**DISCONNECT ALL POWER BEFORE SERVICING OR INSTALLING. MULTIPLE POWER SOURCES MAY BE PRESENT. FAILURE TO DO SO MAY CAUSE PROPERTY DAMAGE, PERSONAL INJURY OR DEATH.**



1. Remove electrical power to unit. Some units may have more than one source of power.
2. Remove the wires from the limit control terminals.
3. Using an ohmmeter, test for continuity across the two terminals.
4. If limit test open allow unit to cool and retest.
5. If still open, replace the control.

## TESTING AUXILIARY LIMIT

The auxiliary limit control is a preset nonadjustable control mounted in the blower compartment area.

It is connected in series with the rollout switch wiring to the gas valve. If its temperature should be exceeded, it will open, interrupting the voltage to the gas valve causing it to open.

An additional limit (primary limit) control is required for safety control of high temperature within the furnace or ductwork.

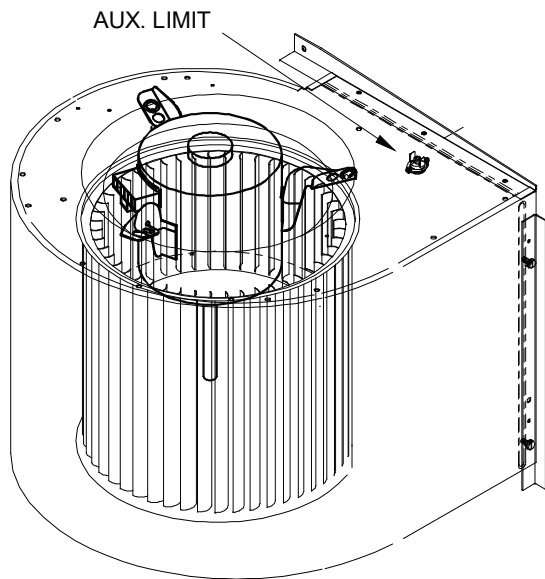



**WARNING**

**HIGH VOLTAGE!**  
**DISCONNECT ALL POWER BEFORE SERVICING OR INSTALLING. MULTIPLE POWER SOURCES MAY BE PRESENT. FAILURE TO DO SO MAY CAUSE PROPERTY DAMAGE, PERSONAL INJURY OR DEATH.**

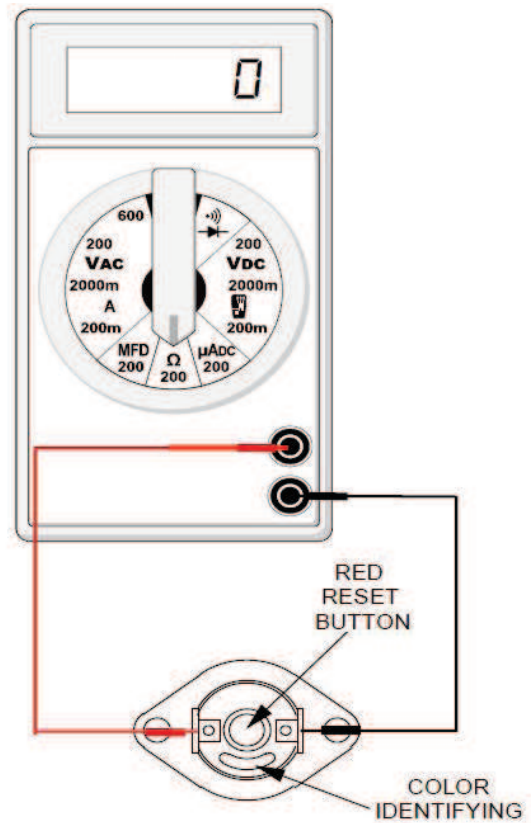

1. Remove the wires from the auxiliary limit control terminals.
2. Using an ohmmeter, test for continuity across the two terminals. No reading indicates the control is open. Push the red reset button, test again - if still open, replace the control.



**TESTING AUXILIARY LIMIT CONTROL**

## CHECKING FLAME ROLLOUT SWITCH

A/GPGM3 units are equipped with a temperature-activated manual reset control. This control is mounted to the manifold assembly and is wired in series with the auxiliary limit and gas valve. The control is designed to open should a flame roll out occur. An overfiring condition or flame impingement on the heat shield can also cause the control to open.

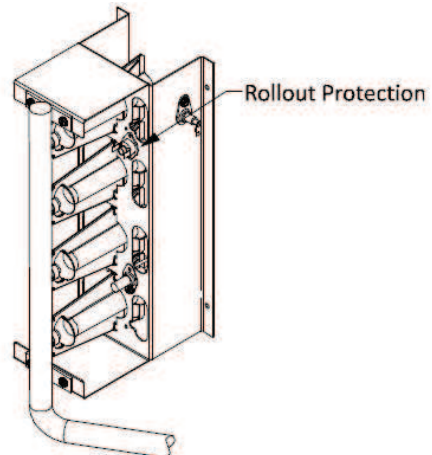

**ROLLOUT PROTECTION ON BURNER BRACKET**

# SERVICING

If the rollout control has opened, the circuit between the ignition control and gas valve will be interrupted and the ignition control module will go into lockout. The servicer should reset the ignition control by opening and closing the thermostat circuit. The servicer should look for the ignitor sparking which indicates there is power to the ignition control. The servicer should measure the voltage between each side of the rollout control and ground while the ignition control is try to power the gas valve.

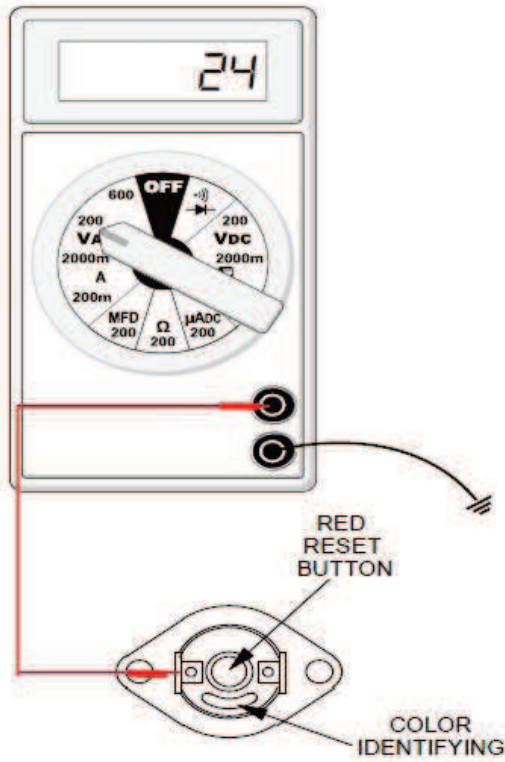

**CHECKING FLAME ROLLOUT SWITCH**

## LIMIT SWITCH OPERATION (APPLIES TO PRIMARY, AUXILIARY, AND ROLL OUT LIMITS) DSI SYSTEMS.

If a limit switch opens, the indoor blower is energized on heat speed and the induced draft blower is energized. The LED on the control flashes “4” to indicate an open limit switch. The blower and inducer remain on while the limit switch is open. The gas valve is de-energized. Power to the thermostat “R” is removed while the limit switch is open.

When the limit switch re-closes, the induced draft motor runs through its post purge and the indoor blower goes through the heat off delay.

If a call for heat exists when the limit switch re-closes, the control goes through a pre-purge period and then makes an ignition attempt. The indoor blower remains on (for the delay off time) during the re-ignition attempt.

1. If no voltage is measured on either side of control it indicates ignition control or wiring to control problem.

2. If voltage is measured on one side of the control and not the other, it indicates the control is open.
3. If voltage is measured on both sides of the control the wiring to gas valve or valve is at fault.

## SERVICING PROCEDURE WITH FURNACE NOT FIRING.

1. Confirm that the outer door was in place and all screws tightened. (No leaks under the door.)
2. Check to see if any damage was done to the furnace especially the wiring.
3. Confirm that heat exchanger is not obstructed by feeling for discharge air from the flue hood when the combustion blower is running but the unit is not firing.

If the above steps do not suggest the reason the control has tripped the furnace should be fired.

1. Remove the heating compartment door.
2. Turn of the power or open the thermostat circuit.
3. Reset the rollout control.
4. Turn power on and put the unit into a call for heating.



## CAUTION

**FLAME ROLLOUT COULD OCCUR. KEEP FACE AND HANDS A SAFE DISTANCE FROM BURNER AREA.**

5. Look under the heat shield as the unit is running. Flames should be drawn into firing tubes.
  - a. If only one burners flame is not drawn into the tube, that tube is restricted.
  - b. If, without the air circulation blower running, all flames are not drawn into the tubes either the collector box, combustion blower, or flue outlet is obstructed. If the combustion blower or flue outlet is obstructed, the pressure switch should have opened preventing the unit from firing, also inspect the unit pressure switch and wiring.
  - c. If the burner flame is not drawn into the tube only when the air circulation blower is running, then a cracked heat exchanger tube is present.

## TESTING INDUCER MOTOR



## WARNING

**HIGH VOLTAGE!**  
**DISCONNECT ALL POWER BEFORE SERVICING OR INSTALLING. MULTIPLE POWER SOURCES MAY BE PRESENT. FAILURE TO DO SO MAY CAUSE PROPERTY DAMAGE, PERSONAL INJURY OR DEATH.**



1. Disconnect the motor wire leads from its connection point at integrated ignition control module.
2. Using an ohmmeter, test for continuity between each of the motor leads.
3. Touch one probe of the ohmmeter to the motor frame (ground) and the other probe in turn to each lead.

# SERVICING

If the windings do not test continuous or a reading is obtained to ground, replace the motor.

4. After completing check and/or replacement of induced draft blower motor.
5. Turn on electrical power and verify proper unit operation.

## TESTING GAS VALVE

### DIRECT SPARK IGNITION (DSI) SYSTEMS

A combination redundant operator type gas valve which provides all manual and automatic control functions required for gas fired heating equipment is used on single stage models.

A two-stage combination redundant operator type gas valve which provides all manual and automatic control functions required for gas fired heating equipment is used on two stage models.

The valve provides control of main burner gas flow, pressure regulation, and 100 percent safety shut-off.

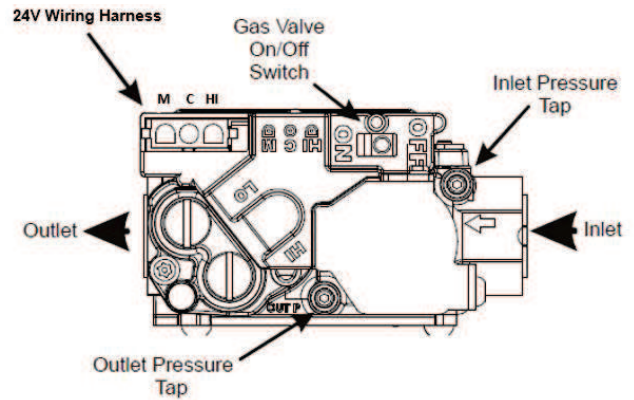

W/R36G54-238

WHITE RODGERS MODEL 36G 2-STAGE GAS VALVE

### CHECKING MAIN BURNERS

The main burners are used to provide complete combustion of various fuels in a limited space, and transfer this heat of the burning process to the heat exchanger.

Proper ignition, combustion, and extinction are primarily due to burner design, orifice sizing, gas pressure, primary and secondary air, vent and proper seating of burners.

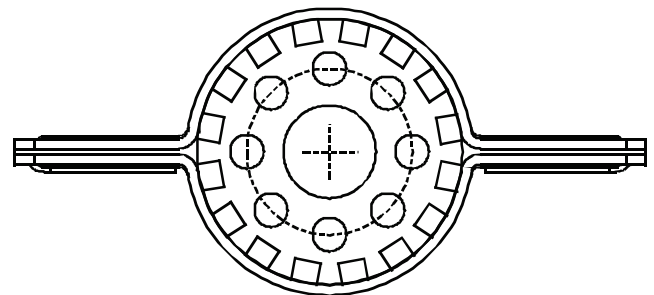

BECKETT BURNER

<b>WARNING</b>
<p><b>HIGH VOLTAGE!</b> DISCONNECT ALL POWER BEFORE SERVICING OR INSTALLING. MULTIPLE POWER SOURCES MAY BE PRESENT. FAILURE TO DO SO MAY CAUSE PROPERTY DAMAGE, PERSONAL INJURY OR DEATH.</p>

1. Ensure gas valve and main gas supply are on.
2. Using a voltmeter, check for 24 volts as noted below for 1- and 2- stage gas valves.
  - a. For 1-stage gas valves, check from the purple and blue wires.
  - b. For 2-stage gas valves, check from C and M terminals on the valve.
3. If 24 volts are present and no gas flows through the valve, replace valve.

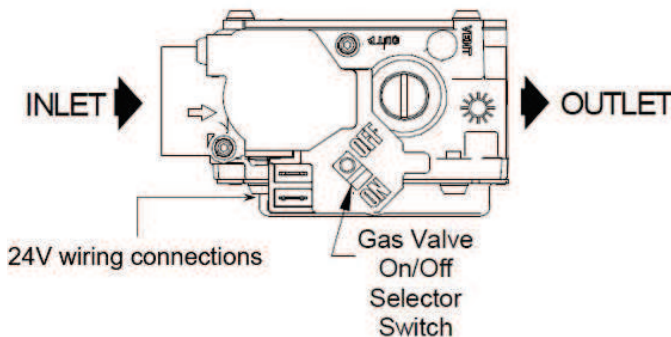

W/R36J22-202

WHITE RODGERS MODEL 36G22 1-STAGE GAS VALVE

<b>WARNING</b>
<p><b>DISCONNECT GAS AND ELECTRICAL POWER SUPPLY.</b></p>

In checking main burners, look for signs of rust, oversized and undersized carry-over ports restricted with foreign material, etc.

### CHECKING ORIFICES

A predetermined fixed gas orifice is used in all of these furnaces. That is an orifice which has a fixed bore and position.

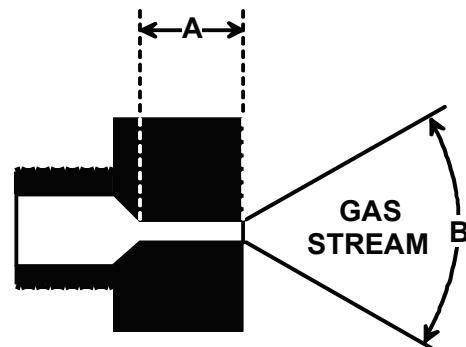



# SERVICING

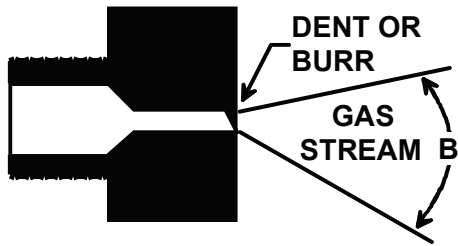

The length of Dimension “A” determines the angle of Gas Stream Defraction, “B”.

A dent or burr will cause severe deflection of gas stream.

No resizing should be attempted until all factors are taken into consideration such as inlet manifold gas pressure, alignment, and positioning, specific gravity and BTU content of the gas being consumed.

The only time resizing is required is when a reduction in firing rate is required for an increase in altitude.

Orifices should be treated with care in order to prevent damage. They should be removed and installed with a box-end wrench in order to prevent distortion. In no instance should an orifice be peened over and redrilled. This will change the angle or deflection of the vacuum effect or entraining of primary air, which will make it difficult to adjust the flame properly. This same problem can occur if an orifice spud of a different length is substituted.

WARNING

---

**DISCONNECT GAS AND ELECTRICAL POWER SUPPLY.**

1. Check orifice visually for distortion and/or burrs.
2. Check orifice size with orifice sizing drills.
3. If resizing is required, a new orifice of the same physical size and angle with proper drill size opening should be installed.

## CHECKING GAS PRESSURE

Gas inlet and manifold pressures should be checked and adjusted in accordance to the type of fuel being consumed.

**NOTE: Use adapter kit #0151K0000S to measure gas pressure on White-Rodgers 36G22 and 36G54 gas valves.**

WARNING

---

**DISCONNECT GAS AND ELECTRICAL POWER SUPPLY.**

1. Connect a digital manometer or adequate gauge to the inlet pressure fitting of the gas valve.

2. Remove the pressure tap fitting at the manifold if provided or check at the gas valve outlet fitting and connect another manometer or gauge.

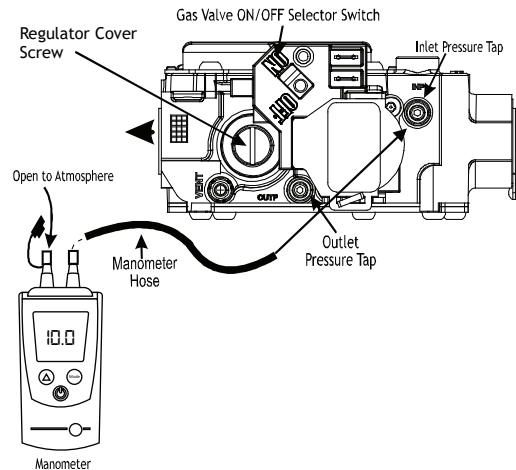

**WHITE RODGERS MODEL 36G 1-STAGE GAS VALVE**

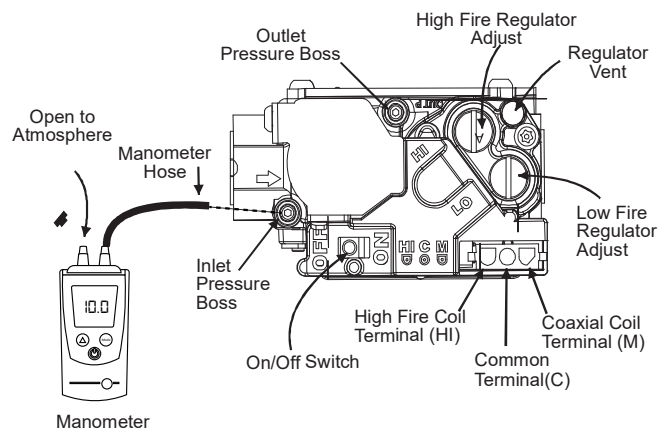

**WHITE RODGERS MODEL 36G 2-STAGE GAS VALVE**

## MEASURING INLET AND MANIFOLD GAS PRESSURE

With power ON:

WARNING

---

**LINE VOLTAGE NOW PRESENT.**

3. Put furnace into heating cycle and turn on all other gas consuming appliances.

For NATURAL GAS:

- a. Inlet pressure should be a nominal 7" w.c.
- b. (2 stage heat models only) Manifold pressure on low stage should be 2.0" w.c. ± .3" w.c.
- c. Manifold pressure for 1 stage heat models and high stage for 2 stage heat models should be 3.5" w.c. ± .3" w.c.

For PROPANE GAS:

- a. Inlet pressure should be a nominal 11" w.c.
- b. (2 stage heat models only) Manifold pressure on low stage should be 6" w.c.



# SERVICING

- c. Manifold pressure for 1 stage heat models and high stage for 2 stage heat models should be 10" w.c.

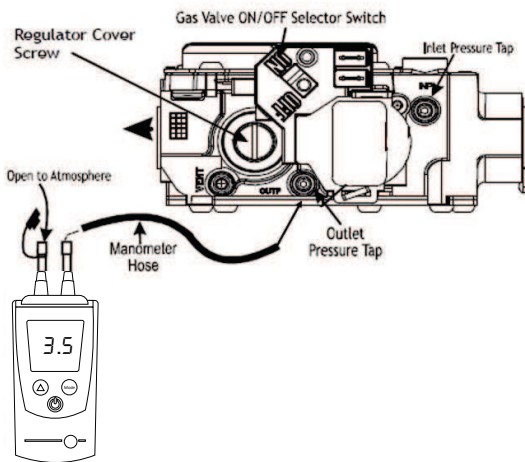

**WHITE-ROGERS MODEL 36J22 CONNECTED TO MANOMETER**

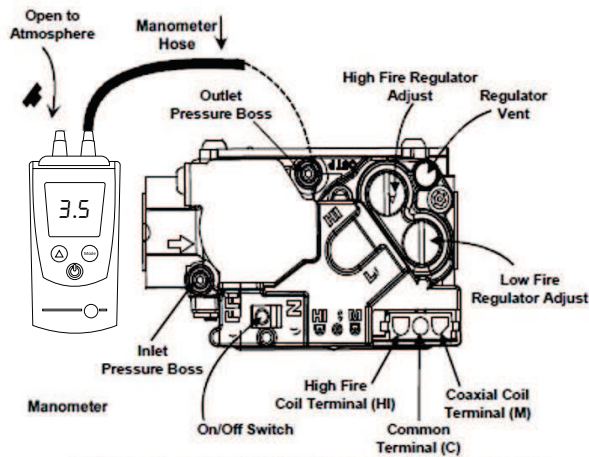

**WHITE-ROGERS MODEL 36J54 CONNECTED TO MANOMETER**

Manifold Gas Pressure	
Natural Gas	3.5" w.c.
Propane Gas	10.0" w.c.

**SINGLE STAGE**

Manifold Gas Pressure			
Gas		Range	Nominal
Natural	Low Stage	1.6 - 2.2" w.c.	2.0" w.c.
	High Stage	3.2 - 3.8" w.c.	3.5" w.c.
Propane	Low Stage	5.7 - 6.3" w.c.	6.0" w.c.
	High Stage	9.7 - 10.3" w.c.	10.0" w.c.

**TWO STAGE**

If operating pressures differ from above, make necessary pressure regulator adjustments, check piping size, etc., and/or consult with local utility.

## CHECKING FOR DELAYED IGNITION

Delayed ignition is a delay in lighting a combustible mixture of gas and air which has accumulated in the combustion chamber.

When the mixture does ignite, it may explode and/or rollout causing burning in the burner venturi.

If delayed ignition should occur, the following should be checked:

1. Improper gas pressure - adjust to proper pressure.  
Improper burner positioning - burners should be in locating slots, level front to rear and left to right.
2. Carry over (lighter tube or cross lighter) obstructed - clean.
3. Main burner orifice(s) deformed, or out of alignment to burner - replace.

## CHECKING FOR FLASHBACK

Flashback will also cause burning in the burner venturi, but is caused by the burning speed being greater than the gas-air flow velocity coming from a burner port.

Flashback may occur at the moment of ignition, after a burner heats up or when the burner turns off. The latter is known as extinction pop.

Since the end results of flashback and delayed ignition can be the same (burning in the burner venturi) a definite attempt should be made to determine which has occurred.

If flashback should occur, check for the following:

1. Improper gas pressure - adjust to proper pressure.  
Check burner for proper alignment and/or replace burner.
2. Improper orifice size - check orifice for obstruction.

## CHECKING PRESSURE CONTROL

A pressure control device is used to measure negative pressure at the induced draft blower motor inlet to detect a partial or blocked flue.



## PRESSURE SWITCH OPERATION (DSI DIRECT SPARK SYSTEM)

The pressure switch is ignored unless there is a call for heat. When the control receives a call for heat, the control checks to see that the pressure switch is open. If the control sees that the pressure switch is closed before the induced draft blower is energized, the LED will flash a code of "2" (to indicate the pressure switch is stuck closed) and the inducer will remain off until the pressure switch opens.

If the pressure switch opens before the ignition period, the induced draft blower will remain on and the control will stay in pre-purge until the pressure switch is closed for an entire 15 second pre-purge period. The LED will flash a code of "3" to indicate open pressure switch.

# SERVICING

If the pressure switch opens after the gas valve has been energized, the control will de-energize the gas valve and run the indoor blower through the heat off delay. The inducer stays on until the pressure switch re-closes. Then the control makes another ignition attempt.

 <b>WARNING</b>
<p><b>HIGH VOLTAGE!</b>  <b>DISCONNECT ALL POWER BEFORE SERVICING OR INSTALLING. MULTIPLE POWER SOURCES MAY BE PRESENT. FAILURE TO DO SO MAY CAUSE PROPERTY DAMAGE, PERSONAL INJURY OR DEATH.</b></p>

1. Remove wires from the electrical terminals.
2. Using a VOM check from Common to NO (Normally Open) - should read open.  
 If switch reads as noted proceed to Step 3, otherwise replace control.
3. Remove the pressure control hose from the control and interconnect with a digital manometer as shown:

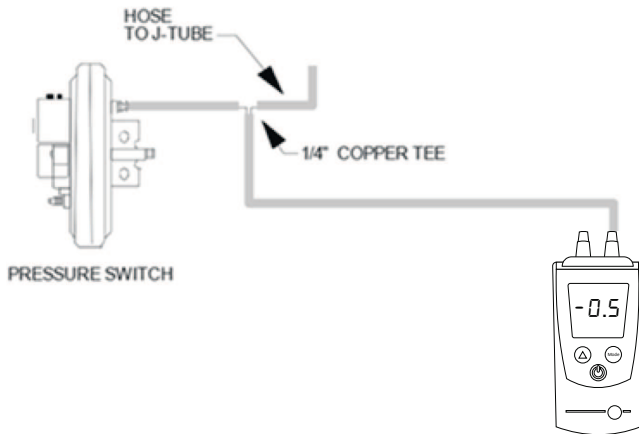

Reconnect wires to the Common and NO terminals.

With Power ON:

 <b>WARNING</b>
<p><b>LINE VOLTAGE NOW PRESENT.</b></p>

4. Energize furnace for heating cycle. The induced draft blower motor will begin to run. The manometer should read approximately  $-1.2'' \pm 0.3''$  W.C with no combustion.
5. Remove and check the two electrical wires and using the VOM check from Common to NO (Normally Open), it should read closed (with I.D. motor running). If not as above, replace pressure control.

6. Reconnect all wires to the control and place in heating cycle.
7. As the unit fires on high stage, the manometer negative pressure will drop to  $-1.0'' \pm 0.3''$  W.C.
8. If not as listed, replace control.

**NOTE: The pressure switch must be mounted with the diaphragm in a vertical position.**

## HIGH ALTITUDE APPLICATION

**HIGH ALTITUDE DERATE - U.S. INSTALLATIONS ONLY**  
**IMPORTANT NOTE: The gas/electric units naturally derate with altitude. Do not attempt to increase the firing rate by changing orifices or increasing the manifold pressure. This can cause poor combustion and equipment failure. At all altitudes, the manifold pressure must be within 0.3 inches W.C. of that listed on the nameplate for the fuel used. At all altitudes and with either fuel, the air temperature rise must be within the range listed on the unit nameplate. Refer to the Installation Manual provided with the LP kit for conversion from natural gas to propane gas and for altitude adjustments.**

When this package unit is installed at high altitude, the appropriate High Altitude orifice kit must be installed. As altitude increases, there is a natural reduction in the density of both the gas fuel and combustion air. This kit will provide the proper design certified input rate within the specified altitude range. High altitude kits are not approved for use in Canada. For installations above 2,000 feet, use kit HA-03. The HA-03 kit is used for both Natural and LP gas at high altitudes.

Use LPM-08 (2 stage heat models) or LPM-07 (1 stage heat models) propane conversion kit for propane conversions at altitudes below 2000 feet. Natural gas installations below 2000 feet do not require a kit.

For propane conversions above 2000 feet, high altitude kit HA-03 is required in addition to the propane conversion kit.

## TESTING IGNITION CONTROL MODULE

**NOTE: Failure to earth ground the unit, or a high resistance connection in the ground may cause the control to lockout due to failure to flame sense.**

 <b>WARNING</b>
<p><b>TO AVOID PERSONAL INJURY OR DEATH DUE TO ELECTRIC SHOCK, WIRING TO THE UNIT MUST BE PROPERLY GROUNDED. DISCONNECT POWER BEFORE INSTALLING OR SERVICING.</b></p>

**NOTE: The flash rate is 0.25 seconds on, 0.25 seconds off, with a 2-second pause between codes.**

# SERVICING

## TESTING DIRECT SPARK IGNITION (DSI) SYSTEMS

Thermostat calling for heat (15 second pre-purge time and 7 second trial for ignition).

1. Check for 230 VAC from L1 terminal of control module to L2. No voltage - check wire connections, continuity, etc.
2. Check for 24 VAC at "R" to "C" thermostat terminals.
  - a. No voltage - check 3 amp automotive type fuse on control board. A blown fuse would indicate a short in the 24 VAC circuit (thermostat or limit circuit).
  - b. Voltage Present - check limit, auxiliary limit and rollout. If limit, auxiliary limit and rollout are closed, then check for 24 VAC at the gas valve terminals.

No 24 VAC at gas valve - replace Control board.

PCBAG123 Ignition Board Fault Codes		
Status Light	Equipment Status	Check
On	Normal Operation	
Off	No Power or Internal Control Fault	Check Input Power, Check Fuse on Control, Replace Control
1 Blink	Ignition Failure, Open Rollout Switch, or Open Aux. Limit Switch	Check Gas Flow, Check Gas Pressure, Check Gas Valve, Check Flame Sensor, Check Flame Rollout, Check Aux. Limit.
2 Blinks	Pressure Switch Open	Check Pressure Switch
3 Blinks	Pressure Switch Closed	Check Pressure Switch
4 Blinks	Open Main Limit Switch	Main Limit Switch Open
5 Blinks	False Flame Sensed	Sticking Gas Valve
6 Blinks	Compressor Output Delay	3 Minute Compressor Anti-Cycle Timer

**NOTE:** The flash rate is 0.25 seconds on, 0.25 seconds off, with a 2-second pause between codes.

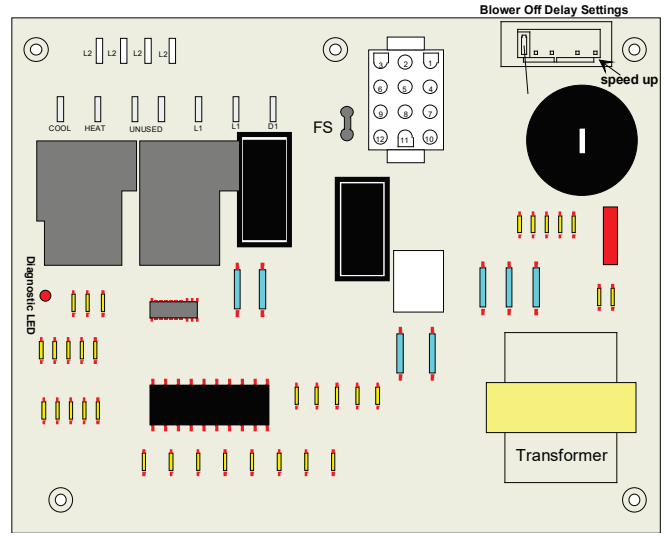

**PCBAG123 DSI CONTROL BOARD**

## TESTING DIRECT SPARK IGNITION (DSI) SYSTEMS PCBAG127 BOARD

### HEATING MODE

Indoor thermostat calling for heat (15 second pre-purge time and 7 second trial for ignition).

1. Check for 230 volts from L1 terminal of control module to L2. No voltage - check wire connections, continuity, etc.
2. Check for 24 volts at "R" to "C" thermostat terminals.
  - a. No voltage - check 3 amp automotive type fuse on control board. A blown fuse could indicate a short in the 24 volt circuit (thermostat or limit circuit).
  - b. Voltage Present - check limit and rollout. If limit and rollout are closed, then check for 24 VAC at the gas valve terminals.
  - c. No 24 VAC at gas valve - check 9 pin connector and wires from ignition control to gas valve. If wires and connections at 9 pin connector check good, replace ignition control.
  - d. Voltage present at gas valve - replace gas valve.

# SERVICING

LED Flashes/Status	System Condition
Off	Internal Control Fault, Micro Controller Detected Hardware Failure, or Gas Valve Detected Energized When it Should be De-energized
1	Lockout Due to Excessive Retries
2	Pressure Switch Stuck Open
3	Pressure Switch Stuck Closed
4	Open High Temperature Limit
5	Flame Present Outside the Flame Detect Mode
6	Compressor Short Cycle Delay Active
7	Limit Opened Five Times within the Same Call for Heat
8	Indoor Thermostat/Outdoor Thermostat is Open
9	Pressure Switch/Loss of Charge Switch is Open
Steady ON	Normal

## RED LED FAULT CODES

LED Flashes/Status	Flame Condition
2	Flame Present Outside the Flame Detect Mode
1	Low Flame Signal Current
Steady ON	Normal Flame
OFF	No Flame Present

## AMBER LED FLAME STATUS CODES

### TESTING HIGH STAGE HEAT OPERATION WITH LOW STAGE HEAT OPERATING:

1. Board set for 2 stage thermostat:
  - a. Check for 24 Volts at thermostat terminals W2 and C on the control board.
  - b. No voltage - check thermostat and thermostat wiring.
  - c. Voltage present - check for 24 volts at gas valve terminals C and HI.
  - d. No voltage present at valve - check 9 pin connector and wires from ignition control to gas valve. If wires and connections at 9 pin connector check good, replace ignition control.
  - e. Voltage present at gas valve - replace gas valve.
2. Board set for 1 stage thermostat:
  - a. Wait the selected delay time (either 5 or 10 minutes, depending on jumper setting).
  - b. Check for 24 volts at gas valve terminals C and HI.

- c. No voltage present - check 9 pin connector and wires from ignition control to gas valve. If wires and connections at 9 pin connector check good, replace ignition control.
- d. Voltage present at gas valve terminals C and HI - replace valve.

### COOLING MODE

Indoor thermostat calling for cool.

1. Check for 230 volts from L1 terminal of control module to L2. No voltage - check wire connections, continuity, etc.
2. Check for 24 volts at R and C thermostat terminals on ignition control.
  - a. No voltage - check 3 amp automotive type fuse on control board. A blown fuse could indicate a short in the 24 volt circuit.
  - b. Voltage present - proceed to step 3.
3. Check for 24 volts at thermostat terminals C and Y1.
  - a. No voltage - check thermostat wiring and thermostat.
  - b. Voltage present - check pressure switch circuit. If pressure switch circuit checks closed, proceed to step 4.
4. Check for 24 volts at contactor coil.
  - a. No voltage - check 6 pin connector and wires from contactor coil to 6 pin connector on control board. If wires and connector check good, replace control.
  - b. Voltage present - replace contactor.

### TESTING HIGH STAGE COOLING OPERATION WITH LOW STAGE COOLING OPERATING:

1. Board set for 2 stage thermostat:
  - a. Check for 24 volts at thermostat terminals C and Y2 on control board.
  - b. No voltage - check thermostat and thermostat wiring.
  - c. Voltage present - check pressure switch circuit. If pressure switch circuit checks closed, proceed to next step.
  - d. Check for 24 volts to compressor unloader solenoid. If no voltage present, check 6 pin connector and wires from compressor unloader solenoid to 6 pin connector on board. If connector and wires check good, replace control.
2. Board set for 1 stage thermostat:
  - a. Wait the selected delay time (either 5 or 10 minutes, depending on jumper setting)
  - b. Check for 24 volts at compressor unloader solenoid.
  - c. No voltage - check 6 pin connector and wires from compressor unloader solenoid to 6 pin connector on board. If connector and wires check good, replace control.

# SERVICING

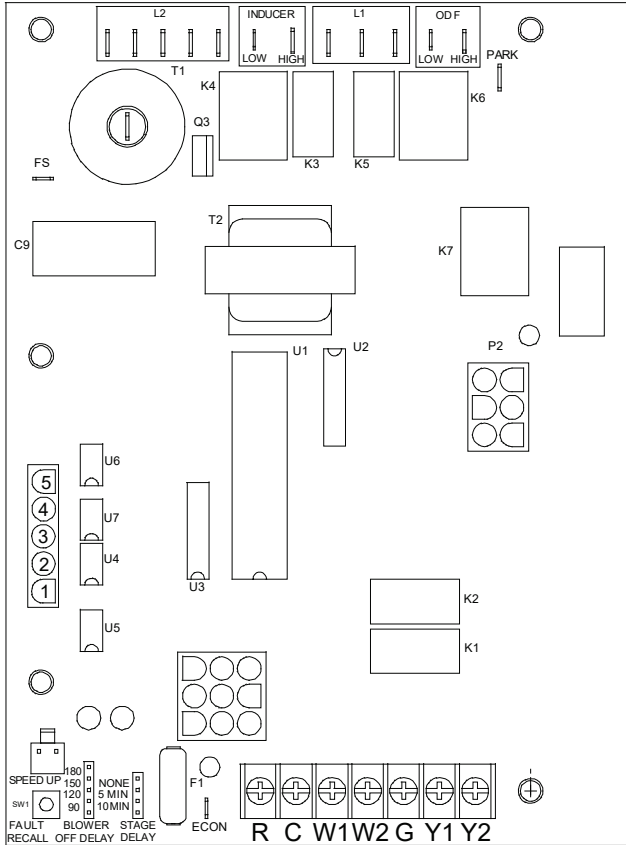

**PCBAG127 DSI CONTROL BOARD**

## CHECKING FLAME SENSOR

A flame sensing device is used in conjunction with the ignition control module to prove combustion. If a microamp signal is not present the control will de-energize the gas valve and “retry” for ignition or lockout.

## DSI DIRECT SPARK IGNITION SYSTEMS

**WARNING**

**HIGH VOLTAGE!**  
DISCONNECT ALL POWER BEFORE SERVICING OR INSTALLING. MULTIPLE POWER SOURCES MAY BE PRESENT. FAILURE TO DO SO MAY CAUSE PROPERTY DAMAGE, PERSONAL INJURY OR DEATH.

1. Disconnect the flame sensor wire from terminal FS of the ignition control module.

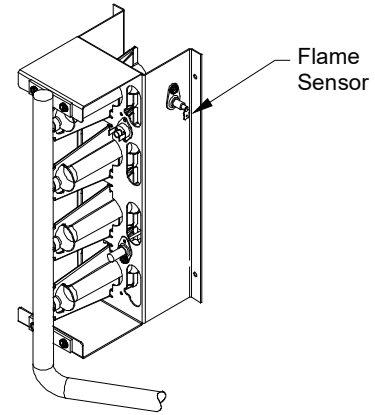

**FLAME SENSOR**

2. Connect a microamp meter in series with this wire and terminal FS.
3. Be sure the negative side of the meter is to the wire and the positive of the meter is to terminal FS.
4. Turn on Power.

**WARNING**  
**LINE VOLTAGE NOW PRESENT.**

5. With Power ON, Place the unit into a heating cycle.
6. As soon as flame is established a microamp reading should be evident once proof of flame (microamp reading) is established, the hot surface ignitor will be de-energized.
7. The nominal microamp reading is 4 microamps.
8. If the microamp current is less than 0.5 microamp the control will lockout and flash a code of 1 flash after attempting to reestablish flame sense.
9. If the microamp reading is less than the minimum specified, check for high resistance wiring connections, the distance (3/16”) between the sensor and burner, flame sensor connections, dirty flame sensor or poor grounding.
10. If no reading, check for continuity on all components and if good - replace ignition control module.

**NOTE: Contaminated fuel or combustion air can create a nearly invisible coating on the flame sensor. This coating works as an insulator causing a loss in the flame sense signal. If this situation occurs the flame sensor must be cleaned with steel wool. Do not use sand paper, the silicone in sand paper will further contaminate the sensor.**



# BLOWER PERFORMANCE DATA

A/GPGM32404041 - Rise Range: 25° - 55°													
E.S.P.	T1 HEATING SPEED			T2 HEATING SPEED			T3 HEATING SPEED			T4 COOLING SPEED		T5 COOLING SPEED	
	CFM	WATTS	RISE	CFM	WATTS	RISE	CFM	WATTS	RISE	CFM	WATTS	CFM	WATTS
0.1	695	62	44	820	93	37	1,050	167	29	1,020	153	1,119	208
0.2	650	71	47	785	100	39	1,010	180	30	985	160	1,110	216
0.3	605	77	51	745	108	41	970	186	32	946	168	1,083	222
0.4	565	89	54	700	117	44	935	192	33	905	175	1,052	229
0.5	480	99	X	665	127	46	890	203	35	863	186	1,017	237
0.6	415	106	X	575	138	53	850	208	36	813	190	979	243
0.7	365	110	X	510	146	X	815	216	38	759	199	934	250
0.8	320	119	X	455	155	X	755	222	41	701	206	879	259

A/GPGM32406041 - Rise Range: 30° - 60°													
E.S.P.	T1 HEATING SPEED			T2 HEATING SPEED			T3 HEATING SPEED			T4 COOLING SPEED		T5 COOLING SPEED	
	CFM	WATTS	RISE	CFM	WATTS	RISE	CFM	WATTS	RISE	CFM	WATTS	CFM	WATTS
0.1	695	62	X	820	93	56	1,050	167	44	1,020	153	1,119	208
0.2	650	71	X	785	100	59	1,010	180	46	985	160	1,110	216
0.3	605	77	X	745	108	X	970	186	48	946	168	1,083	222
0.4	565	89	X	700	117	X	935	192	49	905	175	1,052	229
0.5	480	99	X	665	127	X	890	203	52	863	186	1,017	237
0.6	415	106	X	575	138	X	850	208	54	813	190	979	243
0.7	365	110	X	510	146	X	815	216	57	759	199	934	250
0.8	320	119	X	455	155	X	755	222	X	701	206	879	259

A/GPGM33004041 - Rise Range: 25° - 55°													
E.S.P.	T1 HEATING SPEED			T2 HEATING SPEED			T3 HEATING SPEED			T4 COOLING SPEED		T5 COOLING SPEED	
	CFM	WATTS	RISE	CFM	WATTS	RISE	CFM	WATTS	RISE	CFM	WATTS	CFM	WATTS
0.1	680	61	45	840	103	37	1,035	174	30	1,202	246	1,225	276
0.2	640	72	48	795	109	39	995	184	31	1,173	251	1,185	275
0.3	605	80	51	750	117	41	960	192	32	1,143	258	1,150	289
0.4	555	89	X	710	126	43	925	205	33	1,110	265	1,115	296
0.5	490	93	X	660	132	47	875	200	35	1,073	272	1,085	303
0.6	455	107	X	615	138	50	840	217	37	1,035	278	1,045	312
0.7	395	109	X	570	150	54	795	222	39	994	285	1,000	315
0.8	350	119	X	515	157	X	755	226	41	947	293	960	320

A/GPGM33006041 - Rise Range: 30° - 60°													
E.S.P.	T1 HEATING SPEED			T2 HEATING SPEED			T3 HEATING SPEED			T4 COOLING SPEED		T5 COOLING SPEED	
	CFM	WATTS	RISE	CFM	WATTS	RISE	CFM	WATTS	RISE	CFM	WATTS	CFM	WATTS
0.1	680	61	X	840	103	55	1,035	174	45	1,202	246	1,225	276
0.2	640	72	X	795	109	58	995	184	46	1,173	251	1,185	275
0.3	605	80	X	750	117	X	960	192	48	1,143	258	1,150	289
0.4	555	89	X	710	126	X	925	205	50	1,110	265	1,115	296
0.5	490	93	X	660	132	X	875	200	53	1,073	272	1,085	303
0.6	455	107	X	615	138	X	840	217	55	1,035	278	1,045	312
0.7	395	109	X	570	150	X	795	222	58	994	285	1,000	315
0.8	350	119	X	515	157	X	755	226	X	947	293	960	320

X= Heating Temperature Rise Not Recommended.

# BLOWER PERFORMANCE DATA

A/GPGM33604041** - Rise Range: 25° - 55°													
E.S.P.	T1 HEATING SPEED			T2 HEATING SPEED			T3 HEATING SPEED			T4 COOLING SPEED		T5 COOLING SPEED	
	CFM	WATTS	RISE	CFM	WATTS	RISE	CFM	WATTS	RISE	CFM	WATTS	CFM	WATTS
0.1	745	76	41	1,115	206	28	1,265	285	X	1,448	342	1,440	426
0.2	690	84	45	1,075	215	29	1,230	290	X	1,403	343	1,390	428
0.3	635	91	48	1,030	221	30	1,175	300	26	1,358	354	1,365	440
0.4	570	98	54	985	233	31	1,140	303	27	1,319	361	1,335	440
0.5	505	107	X	940	234	33	1,100	311	28	1,277	366	1,295	456
0.6	450	115	X	895	242	34	1,055	319	29	1,232	376	1,255	456
0.7	395	118	X	845	248	36	1,010	326	30	1,176	386	1,220	465
0.8	345	126	X	785	252	39	960	335	32	1,120	395	1,180	468

A/GPGM33606041 - Rise Range: 30° - 60°													
E.S.P.	T1 HEATING SPEED			T2 HEATING SPEED			T3 HEATING SPEED			T4 COOLING SPEED		T5 COOLING SPEED	
	CFM	WATTS	RISE	CFM	WATTS	RISE	CFM	WATTS	RISE	CFM	WATTS	CFM	WATTS
0.1	745	76	X	1,115	206	41	1,265	285	36	1,448	342	1,440	426
0.2	690	84	X	1,075	215	43	1,230	290	37	1,403	343	1,390	428
0.3	635	91	X	1,030	221	45	1,175	300	39	1,358	354	1,365	440
0.4	570	98	X	985	233	47	1,140	303	40	1,319	361	1,335	440
0.5	505	107	X	940	234	49	1,100	311	42	1,277	366	1,295	456
0.6	450	115	X	895	242	52	1,055	319	44	1,232	376	1,255	456
0.7	395	118	X	845	248	55	1,010	326	46	1,176	386	1,220	465
0.8	345	126	X	785	252	59	960	335	48	1,120	395	1,180	468

A/GPGM336080M41 - Rise Range: 30° - 60°													
E.S.P.	T1 HEATING SPEED			T2 HEATING SPEED			T3 HEATING SPEED			T4 COOLING SPEED		T5 COOLING SPEED	
	CFM	WATTS	RISE	CFM	WATTS	RISE	CFM	WATTS	RISE	CFM	WATTS	CFM	WATTS
0.1	745	76	X	1,115	206	55	1,265	285	49	1,448	342	1,440	426
0.2	690	84	X	1,075	215	57	1,230	290	50	1,403	343	1,390	428
0.3	635	91	X	1,030	221	60	1,175	300	52	1,358	354	1,365	440
0.4	570	98	X	985	233	X	1,140	303	54	1,319	361	1,335	440
0.5	505	107	X	940	234	X	1,100	311	56	1,277	366	1,295	456
0.6	450	115	X	895	242	X	1,055	319	58	1,232	376	1,255	456
0.7	395	118	X	845	248	X	1,010	326	X	1,176	386	1,220	465
0.8	345	126	X	785	252	X	960	335	X	1,120	395	1,180	468

A/GPGM34206041 - Rise Range: 30° - 60°													
E.S.P.	T1 HEATING SPEED			T2 HEATING SPEED			T3 HEATING SPEED			T4 COOLING SPEED		T5 COOLING SPEED	
	CFM	WATTS	RISE	CFM	WATTS	RISE	CFM	WATTS	RISE	CFM	WATTS	CFM	WATTS
0.1	1,055	156	44	1,380	298	33	1,415	327	33	1,542	392	1,637	444
0.2	1,000	166	46	1,320	312	35	1,360	335	34	1,494	403	1,593	454
0.3	940	173	49	1,270	318	36	1,305	343	35	1,437	409	1,541	459
0.4	880	181	52	1,220	327	38	1,260	353	37	1,392	419	1,497	473
0.5	825	189	56	1,160	336	40	1,200	359	38	1,342	430	1,450	478
0.6	760	204	X	1,115	342	41	1,150	371	40	1,295	440	1,407	485
0.7	705	207	X	1,060	347	44	1,110	375	42	1,238	447	1,357	493
0.8	625	210	X	1,000	361	46	1,060	381	44	1,183	454	1,304	502

A/GPGM34208041 - Rise Range: 30° - 60°													
E.S.P.	T1 HEATING SPEED			T2 HEATING SPEED			T3 HEATING SPEED			T4 COOLING		T5 COOLING	
	CFM	WATTS	RISE	CFM	WATTS	RISE	CFM	WATTS	RISE	CFM	WATTS	CFM	WATTS
0.1	1,055	156	58	1,380	298	45	1,415	327	43	1,542	392	1,637	444
0.2	1,000	166	X	1,320	312	47	1,360	335	45	1,494	403	1,593	454
0.3	940	173	X	1,270	318	48	1,305	343	47	1,437	409	1,541	459
0.4	880	181	X	1,220	327	50	1,260	353	49	1,392	419	1,497	473
0.5	825	189	X	1,160	336	53	1,200	359	51	1,342	430	1,450	478
0.6	760	204	X	1,115	342	55	1,150	371	53	1,295	440	1,407	485
0.7	705	207	X	1,060	347	58	1,110	375	55	1,238	447	1,357	493
0.8	625	210	X	1,000	361	X	1,060	381	58	1,183	454	1,304	502

X= Heating Temperature Rise Not Recommended.

# BLOWER PERFORMANCE DATA

A/GPGM34806041 - Rise Range: 30° - 60°													
E.S.P.	T1 HEATING SPEED			T2 HEATING SPEED			T3 HEATING SPEED			T4 COOLING SPEED		T5 COOLING SPEED	
	CFM	WATTS	RISE	CFM	WATTS	RISE	CFM	WATTS	RISE	CFM	WATTS	CFM	WATTS
0.1	1,055	156	44	1,380	298	33	1,415	327	33	1,851	679	1,780	647
0.2	1,000	166	46	1,320	312	35	1,360	335	34	1,803	688	1,740	658
0.3	940	173	49	1,270	318	36	1,305	343	35	1,754	696	1,695	661
0.4	880	181	52	1,220	327	38	1,260	353	37	1,706	702	1,640	679
0.5	825	189	56	1,160	336	40	1,200	359	38	1,665	710	1,595	675
0.6	760	204	X	1,115	342	41	1,150	371	40	1,619	719	1,550	693
0.7	705	207	X	1,060	347	44	1,110	375	42	1,573	727	1,505	690
0.8	625	210	X	1,000	361	46	1,060	381	44	1,528	739	1,465	696

A/GPGM34808041 - Rise Range: 30° - 60°													
E.S.P.	T1 HEATING SPEED			T2 HEATING SPEED			T3 HEATING SPEED			T4 COOLING SPEED		T5 COOLING SPEED	
	CFM	WATTS	RISE	CFM	WATTS	RISE	CFM	WATTS	RISE	CFM	WATTS	CFM	WATTS
0.1	1,055	156	58	1,380	298	45	1,415	327	43	1,851	679	1,780	647
0.2	1,000	166	X	1,320	312	47	1,360	335	45	1,803	688	1,740	658
0.3	940	173	X	1,270	318	48	1,305	343	47	1,754	696	1,695	661
0.4	880	181	X	1,220	327	50	1,260	353	49	1,706	702	1,640	679
0.5	925	189	X	1,160	336	53	1,200	359	51	1,665	710	1,595	675
0.6	760	204	X	1,115	342	55	1,150	371	53	1,619	719	1,550	693
0.7	705	207	X	1,060	347	58	1,110	375	55	1,573	727	1,505	690
0.8	625	210	X	1,000	361	X	1,060	381	58	1,528	739	1,465	696

A/GPGM348100341 - Rise Range: 35° - 65°													
E.S.P.	T1 HEATING SPEED			T2 HEATING SPEED			T3 HEATING SPEED			T4 COOLING SPEED		T5 COOLING SPEED	
	CFM	WATTS	RISE	CFM	WATTS	RISE	CFM	WATTS	RISE	CFM	WATTS	CFM	WATTS
0.1	1,055	156	X	1,380	298	56	1,570	327	49	1,851	679	1,780	647
0.2	1,000	166	X	1,320	312	58	1,520	335	51	1,803	688	1,740	658
0.3	940	173	X	1,270	318	61	1,480	343	52	1,754	696	1,695	661
0.4	880	181	X	1,220	327	63	1,425	353	54	1,706	702	1,640	679
0.5	825	189	X	1,160	336	X	1,380	359	56	1,665	710	1,595	675
0.6	760	204	X	1,115	342	X	1,335	371	58	1,619	719	1,550	693
0.7	705	207	X	1,060	347	X	1,285	375	60	1,573	727	1,505	690
0.8	625	210	X	1,000	361	X	1,235	381	62	1,528	739	1,465	696

X= Heating Temperature Rise Not Recommended.

# BLOWER PERFORMANCE DATA

A/GPGM36108041 - Rise Range: 30° - 60°												
E.S.P.	T1 LOW STAGE HEATING SPEED			T2 HIGH STAGE HEATING SPEED			T3 LOW STAGE HEATING SPEED		T4 HIGH STAGE COOLING SPEED		T5 COOLING SPEED	
	CFM	WATTS	RISE	CFM	WATTS	RISE	CFM	WATTS	CFM	WATTS	CFM	WATTS
0.1	1,285	252	36	1,370	297	45	1,420	284	2,044	757	2,107	831
0.2	1,235	259	37	1,330	304	46	1,371	294	1,996	770	2,060	837
0.3	1,180	272	39	1,280	314	48	1,318	302	1,955	779	2,015	850
0.4	1,130	272	41	1,220	321	50	1,268	313	1,913	785	1,972	858
0.5	1,085	280	42	1,180	341	52	1,217	326	1,871	796	1,930	864
0.6	1,035	294	45	1,135	339	54	1,163	341	1,828	803	1,888	875
0.7	975	297	47	1,085	347	57	1,101	347	1,788	809	1,850	885
0.8	910	319	51	1,035	359	59	1,041	358	1,742	822	1,805	889

A/GPGM36110041 - Rise Range: 35° - 65°												
E.S.P.	T1 LOW STAGE HEATING SPEED			T2 HIGH STAGE HEATING SPEED			T3 LOW STAGE HEATING SPEED		T4 HIGH STAGE COOLING SPEED		T5 COOLING SPEED	
	CFM	WATTS	RISE	CFM	WATTS	RISE	CFM	WATTS	CFM	WATTS	CFM	WATTS
0.1	1,175	169	49	1,485	311	52	1,420	284	2,044	757	2,107	831
0.2	1,115	178	52	1,425	317	54	1,371	294	1,996	770	2,060	837
0.3	1,045	183	55	1,385	331	55	1,318	302	1,955	779	2,015	850
0.4	985	194	59	1,350	341	57	1,268	313	1,913	785	1,972	858
0.5	905	199	64	1,295	351	59	1,217	326	1,871	796	1,930	864
0.6	840	215	X	1,235	359	62	1,163	341	1,828	803	1,888	875
0.7	770	218	X	1,180	371	X	1,101	347	1,788	809	1,850	885
0.8	700	229	X	1,125	386	X	1,041	358	1,742	822	1,805	889

A/GPGM36112041 - Rise Range: 35° - 65°												
E.S.P.	T1 LOW STAGE HEATING SPEED			T2 HIGH STAGE HEATING SPEED			T3 LOW STAGE HEATING SPEED		T4 HIGH STAGE COOLING SPEED		T5 COOLING SPEED	
	CFM	WATTS	RISE	CFM	WATTS	RISE	CFM	WATTS	CFM	WATTS	CFM	WATTS
0.1	1,345	281	51	1,745	558	53	1,420	284	2,044	757	2,107	831
0.2	1,300	286	53	1,705	567	54	1,371	294	1,996	770	2,060	837
0.3	1,255	295	55	1,660	572	56	1,318	302	1,955	779	2,015	850
0.4	1,205	308	57	1,620	582	57	1,268	313	1,913	785	1,972	858
0.5	1,165	322	59	1,580	589	58	1,217	326	1,871	796	1,930	864
0.6	1,110	335	62	1,535	604	60	1,163	341	1,828	803	1,888	875
0.7	1,055	334	X	1,485	613	62	1,101	347	1,788	809	1,850	885
0.8	1,010	346	X	1,435	606	64	1,041	358	1,742	822	1,805	889

X= Heating Temperature Rise Not Recommended.

# BLOWER PERFORMANCE DATA

APGM52406041** - Rise Range: 25° - 55°						
Tap	Low Cool	High Cool	Low Heat		High Heat	
			CFM	Rise	CFM	Rise
A-	505	675	540	63	720	63
A	565	750	600	56	800	56
A+	620	825	660	51	880	51
B-	540	720	610	55	810	56
B	600	800	675	50	900	50
B+	660	880	745	45	990	45
C-	560	745	660	51	880	51
C	620	825	735	46	980	46
C+	685	910	810	42	1075	42
D-	575	765	X	X	X	X
D	640	850	X	X	X	X
D+	700	935	X	X	X	X

APGM53006041** - Rise Range: High Fire 35° - 65° Low Fire 25° - 55°						
Tap	Low Cool	High Cool	Low Heat		High Heat	
			CFM	Rise	CFM	Rise
A-	545	810	720	63	960	63
A	605	900	800	56	1065	56
A+	665	990	880	51	1170	51
B-	605	900	810	56	1075	56
B	670	1000	900	50	1195	50
B+	735	1100	990	45	1315	46
C-	650	970	900	50	1195	50
C	720	1075	1000	45	1330	45
C+	795	1185	1100	41	1465	41
D-	665	990	X	X	X	X
D	735	1100	X	X	X	X
D+	810	1210	X	X	X	X

APGM53608041** - Rise Range: 35° - 65°						
Tap	Low Cool	High Cool	Low Heat		High Heat	
			CFM	Rise	CFM	Rise
A-	680	1015	720	63	960	63
A	755	1125	800	56	1065	56
A+	830	1240	880	51	1170	51
B-	725	1080	810	56	1075	56
B	805	1200	900	50	1195	50
B+	885	1320	990	45	1315	46
C-	755	1125	900	50	1195	50
C	840	1250	1000	45	1330	45
C+	920	1375	1100	41	1465	41
D-	800	1195	X	X	X	X
D	890	1325	X	X	X	X
D+	980	1460	X	X	X	X

APGM54210041** - Rise Range: 35° - 65°						
Tap	Low Cool	High Cool	Low Heat		High Heat	
			CFM	Rise	CFM	Rise
A-	970	1170	915	61	1215	62
A	1080	1300	1015	55	1350	56
A+	1185	1430	1115	50	1485	51
B-	1045	1260	1015	55	1350	56
B	1160	1400	1125	50	1495	50
B+	1280	1540	1240	45	1650	45
C-	1085	1305	1125	50	1495	50
C	1205	1450	1250	45	1665	45
C+	1325	1595	1375	41	1830	41
D-	1120	1350	X	X	X	X
D	1245	1500	X	X	X	X
D+	1370	1650	X	X	X	X

APGM54810041** - Rise Range: 35° - 65°						
Tap	Low Cool	High Cool	Low Heat		High Heat	
			CFM	Rise	CFM	Rise
A-	1150	1305	900	63	1195	63
A	1275	1450	1000	56	1330	56
A+	1405	1595	1100	51	1465	51
B-	1190	1350	1015	55	1350	56
B	1320	1500	1125	50	1495	50
B+	1450	1650	1240	45	1650	45
C-	1230	1395	1125	50	1495	50
C	1365	1550	1250	45	1665	45
C+	1500	1705	1375	41	1830	41
D-	1265	1440	X	X	X	X
D	1410	1600	X	X	X	X
D+	1550	1760	X	X	X	X

X = Outside of Temperature Rise Range - Not Recommended.



# BLOWER PERFORMANCE DATA

## APGM5\*\* CFM OUTPUT AND DIP SWITCH SETTINGS

MODEL	SPEED TAP	CFM Output for DIP Switches 1 -2 / Heating				CFM Output for DIP Switches 5 - 6 / Cooling			
		Switch 1	Switch 2	Low Heat CFM	High Heat CFM	Switch 5	Switch 6	Low Cool CFM	High Cool CFM
APGM52406041**	A	OFF	OFF	600	800	OFF	OFF	565	750
	B	ON	OFF	675	900	ON	OFF	600	800
	C	OFF	ON	735	980	OFF	ON	620	825
	D	ON	ON	X	X	ON	ON	640	850
APGM53008041**	A	OFF	OFF	800	1065	OFF	OFF	605	900
	B	ON	OFF	900	1195	ON	OFF	670	1000
	C	OFF	ON	1000	1330	OFF	ON	720	1075
	D	ON	ON	X	X	ON	ON	735	1100
APGM53608041**	A	OFF	OFF	800	1065	OFF	OFF	755	1125
	B	ON	OFF	900	1195	ON	OFF	805	1200
	C	OFF	ON	1000	1330	OFF	ON	840	1250
	D	ON	ON	X	X	ON	ON	890	1325
APGM54210041**	A	OFF	OFF	1015	1350	OFF	OFF	1080	1300
	B	ON	OFF	1125	1495	ON	OFF	1160	1400
	C	OFF	ON	1250	1665	OFF	ON	1205	1450
	D	ON	ON	X	X	ON	ON	1245	1500
APGM54810041**	A	OFF	OFF	1015	1350	OFF	OFF	1275	1450
	B	ON	OFF	1125	1495	ON	OFF	1320	1500
	C	OFF	ON	1250	1665	OFF	ON	1365	1550
	D	ON	ON	X	X	ON	ON	1410	1600

x = Not recommended for heating application

### DIP Switch Settings for Single and Two-Stage Thermostats

MODEL	SWITCH 3	SWITCH 4	THERMOSTAT
APGM5**	N/A	ON	Single Stage
	N/A	OFF	Two-Stage

### Adjustments Through Dip Switch Combinations 7-8

CFM	SWITCH 7	SWITCH 8
+10%	ON	OFF
Normal	OFF	OFF
-10%	OFF	ON

# BLOWER PERFORMANCE DATA

GPGM52406041 - Rise Range: 25° - 55°												
E.S.P.	T1 LOW STAGE HEATING SPEED			T2 HIGH STAGE HEATING SPEED			T3 LOW STAGE COOLING SPEED		T4 HIGH STAGE COOLING SPEED		T5 COOLING SPEED	
	CFM	WATTS	RISE	CFM	WATTS	RISE	CFM	WATTS	CFM	WATTS	CFM	WATTS
0.1	700	76	48	1080	197	42	744	72	1021	149	1090	197
0.2	665	84	51	1032	204	44	696	79	976	157	1055	201
0.3	614	91	55	988	212	46	646	86	932	164	1020	207
0.4	561	98	60	948	220	47	591	93	885	171	995	212
0.5	505	105	67	902	225	50	524	99	844	178	955	230
0.6	438	114	77	859	231	52	466	106	795	185	915	240
0.7	374	119	90	813	238	55	405	111	744	192	880	255
0.8	318	125	106	770	245	58	356	116	693	199	835	246

GPGM530080M41 - Rise Range: 35° - 65°												
E.S.P.	T1 LOW STAGE HEATING SPEED			T2 HIGH STAGE HEATING SPEED			T3 LOW STAGE COOLING SPEED		T4 HIGH STAGE COOLING SPEED		T5 COOLING SPEED	
	CFM	WATTS	RISE	CFM	WATTS	RISE	CFM	WATTS	CFM	WATTS	CFM	WATTS
0.1	1035	156	43	1300	287	46	848	89	1171	201	1295	289
0.2	990	165	45	1265	293	47	797	96	1127	208	1260	294
0.3	950	173	47	1220	310	49	740	104	1087	217	1220	304
0.4	910	184	49	1190	306	50	680	112	1043	224	1180	313
0.5	865	190	52	1145	319	52	615	120	990	231	1140	319
0.6	820	200	55	1105	320	54	551	126	941	239	1105	326
0.7	765	204	59	1070	330	56	462	132	885	245	1055	334
0.8	725	211	62	1015	338	59	384	138	826	251	1015	337

GPGM53608041 - Rise Range: 35° - 65°												
E.S.P.	T1 LOW STAGE HEATING SPEED			T2 HIGH STAGE HEATING SPEED			T3 LOW STAGE COOLING SPEED		T4 HIGH STAGE COOLING SPEED		T5 COOLING SPEED	
	CFM	WATTS	RISE	CFM	WATTS	RISE	CFM	WATTS	CFM	WATTS	CFM	WATTS
0.1	950	115	47	1245	230	48	960	134	1450	396	1440	354
0.2	895	124	50	1195	238	50	897	142	1400	405	1390	365
0.3	840	134	54	1150	247	52	828	148	1349	413	1355	369
0.4	775	146	58	1095	256	55	766	156	1302	420	1300	383
0.5	710	152	63	1045	263	57	695	163	1253	428	1260	396
0.6	650	160	X	990	277	61	634	168	1203	436	1210	402
0.7	590	163	X	935	285	64	571	173	1152	442	1160	397
0.8	540	171	X	870	288	X	509	178	1102	449	1110	415

GPGM54210041 - Rise Range: 35° - 65°												
E.S.P.	T1 LOW STAGE HEATING SPEED			T2 HIGH STAGE HEATING SPEED			T3 LOW STAGE COOLING SPEED		T4 HIGH STAGE COOLING SPEED		T5 COOLING SPEED	
	CFM	WATTS	RISE	CFM	WATTS	RISE	CFM	WATTS	CFM	WATTS	CFM	WATTS
0.1	1100	172	51	1420	325	53	1210	220	1571	430	1620	484
0.2	1040	181	54	1360	331	55	1140	226	1520	439	1575	489
0.3	985	185	57	1310	342	57	1085	235	1472	448	1530	497
0.4	920	193	61	1275	353	59	1023	243	1403	454	1490	500
0.5	875	203	64	1210	360	62	963	250	1356	463	1450	507
0.6	815	207	X	1165	368	64	901	259	1302	470	1405	518
0.7	765	215	X	1115	369	X	846	266	1247	476	1345	516
0.8	710	216	X	1075	385	X	786	271	1188	480	1300	528

GPGM54810041 - Rise Range: 35° - 65°												
E.S.P.	T1 LOW STAGE HEATING SPEED			T2 HIGH STAGE HEATING SPEED			T3 LOW STAGE COOLING SPEED		T4 HIGH STAGE COOLING SPEED		T5 COOLING SPEED	
	CFM	WATTS	RISE	CFM	WATTS	RISE	CFM	WATTS	CFM	WATTS	CFM	WATTS
0.1	1085	171	52	1410	326	53	1326	287	1601	733	1790	641
0.2	1035	178	54	1365	329	55	1273	294	1544	744	1745	650
0.3	985	184	57	1315	337	57	1222	303	1485	751	1710	659
0.4	925	193	61	1270	353	59	1172	311	1435	760	1670	663
0.5	870	198	65	1220	360	61	1123	319	1383	766	1625	674
0.6	815	208	X	1175	372	64	1073	328	1333	779	1585	672
0.7	760	213	X	1115	375	X	1027	337	1279	787	1540	675
0.8	710	219	X	1080	381	X	978	344	1219	792	1495	683

X = Outside of Temperature Rise Range Not Recommended.

# BLOWER PERFORMANCE DATA

5 Ton

Models: APGM56014041

Standard Static Drive

Burners High Fire Input: 135,000 BTU/HR

Down Flow					Horizontal Flow				
Speed Tap	External Static Pressure (ESP), in w.c.	SCFM	RPM	BHP	Speed Tap	External Static Pressure (ESP), in w.c.	SCFM	RPM	BHP
T1	0.2	983	570	0.14	T1	0.2	1003	606	0.14
	0.4	833	659	0.16		0.4	850	701	0.17
	0.6	703	739	0.18		0.6	718	785	0.19
	0.8	574	808	0.19		0.8	586	858	0.20
T2	0.2	1175	640	0.20	T2	0.2	1229	617	0.19
	0.4	1057	714	0.22		0.4	1105	699	0.22
	0.6	902	801	0.25		0.6	945	795	0.24
	0.8	790	874	0.27		0.8	844	861	0.27
T3	0.2	1963	883	0.66	T3	0.2	2032	853	0.63
	0.4	1858	939	0.70		0.4	1941	908	0.67
	0.6	1760	990	0.74		0.6	1850	966	0.72
	0.8	1668	1038	0.77		0.8	1757	1018	0.76
T4	0.2	1963	883	0.66	T4	0.2	2032	853	0.63
	0.4	1858	939	0.70		0.4	1941	908	0.67
	0.6	1760	990	0.74		0.6	1850	966	0.72
	0.8	1668	1038	0.77		0.8	1757	1018	0.76
T5	0.2	2369	2196	2.09	T5	0.2	2323	929	0.88
	0.4	2248	987	0.94		0.4	2245	978	0.93
	0.6	2144	1024	0.97		0.6	2161	1028	0.98
	0.8	2054	1070	1.02		0.8	2080	1079	1.03

Shaded area indicates air flow below 1500 SCFM (300 SCFM/ton) that is not recommended for High Stage cooling or heating

# TROUBLESHOOTING

## TROUBLESHOOTING

### IGNITION CONTROL ERROR CODES

The following presents probable causes of questionable unit operation. Refer to Diagnostic Indicator Chart for an interpretation of the signal and to this section for an explanation.

Remove the control box access panel and note the number of diagnostic LED flashes. Refer to Diagnostic Indicator Chart for an interpretation of the signal and to this section for an explanation.

### Fault Recall (Two-Stage Models ONLY)

The ignition control is equipped with a momentary push-button switch that can be used to display on the diagnostic LED the last five faults detected by the control. The control must be in Standby Mode (no thermostat inputs) to use the feature. Depress the push-button switch for approximately 2 seconds. NOTE: Do not hold for longer than 4 seconds. Holding the button for 4 seconds or higher will erase the memory! Release the switch when the LED is turned off. The diagnostic LED will then display the flash codes associated with the last five detected faults. The order of display is the most recent fault to the least recent fault.

### ABNORMAL OPERATION - HEATING

#### Internal Control Failure

If the integrated ignition control in this unit encounters an internal fault, it will go into a "hard" lockout and turn off the diagnostic LED. If diagnostic LED indicates an internal fault, check power supply to unit for proper voltage, check all fuses, circuit breakers and wiring. Disconnect electric power for five seconds. If LED remains off after restoring power, replace control.

#### External Lockout

An external lockout occurs if the integrated ignition control determines that a measurable combustion cannot be established within three (3) consecutive ignition attempts. If flame is not established within the seven (7) second trial for ignition, the gas valve is de-energized, 15 second inter-purge cycle is completed, and ignition is reattempted. The control will repeat this routine three times if a measurable combustion is not established. The control will then shut off the induced draft blower and go into a lockout state.

If flame is established but lost, the control will energize the circulator blower at the heat speed and then begin a new ignition sequence. If flame is established then lost on subsequent attempts, the control will recycle for four (4) consecutive ignition attempts (five attempts total) before locking out.

The diagnostic fault code is 1 flash for a lockout due to failed ignition attempts or flame dropouts. The integrated control will automatically reset after one hour, or it can be reset by removing the thermostat signal or disconnecting the electrical power supply for over five seconds. If the diagnostic LED indicates an external lockout, perform the following checks:

- *Check the supply and manifold pressures*
- *Check the gas orifices for debris*
- *Check gas valve for proper operation*
- *Check secondary limit*

A dirty filter, excessive duct static, insufficient air flow, a faulty limit, or a failed circulator blower can cause this limit to open. Check filters, total external duct static, circulator blower motor, blower motor speed tap (see wiring diagram), and limit. An interruption in electrical power during a heating cycle may also cause the auxiliary limit to open. The automatic reset secondary limit is located on top of the circulator blower assembly.

- *Check rollout limit*

If the burner flames are not properly drawn into the heat exchanger, the flame rollout protection device will open. Possible causes are restricted or blocked flue passages, blocked or cracked heat exchanger, a failed induced draft blower, or insufficient combustion air. The rollout protection device is a manual reset limit located on the burner bracket. The cause of the flame rollout must be determined and corrected before resetting the limit.

- *Check flame sensor*

A drop in flame signal can be caused by nearly invisible coating on the sensor. Remove the sensor and carefully clean with steel wool.

- *Check wiring*

Check wiring for opens/shorts and miswiring.

**IMPORTANT: If you have to frequently reset your gas/ electric package unit, it means that a problem exists that should be corrected. Contact a qualified servicer for further information.**

#### Pressure Switch Stuck Open

A pressure switch stuck open can be caused by a faulty pressure switch, faulty wiring, a disconnected or damaged hose, a blocked or restricted flue, or a faulty induced draft blower.

If the control senses an open pressure switch during the pre-purge cycle, the induced draft blower only will be energized. If the pressure switch opens after ignition has begun the gas valve is de-energized, the circulator blower heat off cycle begins, and the induced draft blower remains on. The diagnostic fault code is two flashes.

#### Pressure Switch Stuck Closed

A stuck closed pressure switch can be caused by a faulty pressure switch or faulty wiring. If the control encounters a pressure switch stuck closed, the induced draft blower remains off. The diagnostic LED code for this fault is three (3) flashes.

# TROUBLESHOOTING

## **Open Thermal Protection Device**

If the primary limit switch opens, the gas valve is immediately de-energized, the induced draft and air circulating blowers are energized. The induced draft and air circulator blowers remain energized until the limit switch recloses. The diagnostic fault code for an open limit is four (4) flashes.

A primary limit will open due to excessive supply air temperatures. This can be caused by a dirty filter, excessive duct static, insufficient air flow, or a faulty limit. Check filters, total external duct static, blower motor, blower motor speed tap (see wiring diagram), and limit. This limit will automatically reset once the temperature falls below a preset level.

## **Primary Limit**

A primary limit will open due to excessive supply air temperatures. This can be caused by a dirty filter, excessive duct static, insufficient air flow, or a faulty limit. Check filters, total external duct static, blower motor, blower motor speed tap (see wiring diagram), and limit. This limit will automatically reset once the temperature falls below a preset level.

## **Auxiliary/Secondary Limit**

A dirty filter, excessive duct static, insufficient air flow, a faulty limit, or a failed circulator blower can cause this limit to open. Check filters, total external duct static, circulator blower motor, blower motor speed tap (see wiring diagram), and limit. An interruption in electrical power during a heating cycle may also cause the auxiliary limit to open. The automatic reset secondary limit is located on top of the circulator blower assembly.

## **Rollout Limit**

If the burner flames are not properly drawn into the heat exchanger, the flame rollout protection device will open. Possible causes are restricted or blocked flue passages, blocked or cracked heat exchanger, a failed induced draft blower, or insufficient combustion air. The rollout protection device is a manual reset limit located on the burner bracket. The cause of the flame rollout must be determined and corrected before resetting the limit.

## **Flame Detected with Gas Valve Closed**

If flame is detected with the gas valve de-energized, the combustion and air circulator blowers are energized. The diagnostic fault code is five (5) flashes for this condition. The control can be reset by removing the power supply to the unit or it will automatically reset after one hour. Miswiring is the probable cause for this fault.

## **Low Flame Signal (Two-Stage Models ONLY)**

Under some conditions, the fuel or air supply can create a nearly invisible coating on the flame sensor. This coating acts as an insulator causing a drop in the flame signal. If the flame signal drops below a predetermined value, the ignition control will display an error code of (1) flash on the amber diagnostic LED. The unit will continue to operate until the control can no longer detect flame.

## ***ABNORMAL OPERATION - COOLING***

### **SHORT CYCLE COMPRESSOR DELAY**

The automatic ignition control has a built-in feature that prevents damage to the compressor in short cycling situations. In the event of intermittent power losses or intermittent thermostat operation, the ignition control will delay output to the compressor contactor for three minutes from the time power is restored. (Compressor is off a total of three minutes). The diagnostic LED will flash six (6) times to indicate the compressor contactor output is being delayed.

**NOTE: Some electronic thermostats also have a built-in compressor short cycle timer that may be longer than the three minute delay given above. If you are using an electronic thermostat and the compressor has not started after three minutes, wait an additional five minutes to allow the thermostat to complete its short cycle delay time.**

### **High Pressure Switch/Low Pressure Switch (5-Ton Models ONLY)**

Some models include a high pressure cutout switch and/or a loss of charge cutout switch. The high pressure cutout switch protects the refrigeration system from excessive operating pressures. The loss of charge cutout switch protects the refrigeration system from very low operating pressures due to a loss of refrigerant. Compressor operation will be disabled if either of these devices opens. If either device opens, the diagnostic red LED will flash (9) times to indicate that a refrigeration system pressure switch is open.



# TROUBLESHOOTING

## IGNITION CONTROL DIAGNOSTIC INDICATOR CHART (SINGLE STAGE MODELS ONLY)

Red Light Signal	Refer to Abnormal Heating or Cooling Operation Sections of this Manual
Off	Internal Control Failure
1 Flash	External Lockout
2 Flashes	Pressure Switch Stuck Open
3 Flashes	Pressure Switch Stuck Closed
4 Flashes	Thermal Protection Device Open
5 Flashes	Flame Detected with Gas Valve Closed
6 Flashes	Short Cycle Compressor Delay (Cooling Only)

### HEATING TIMING CHART

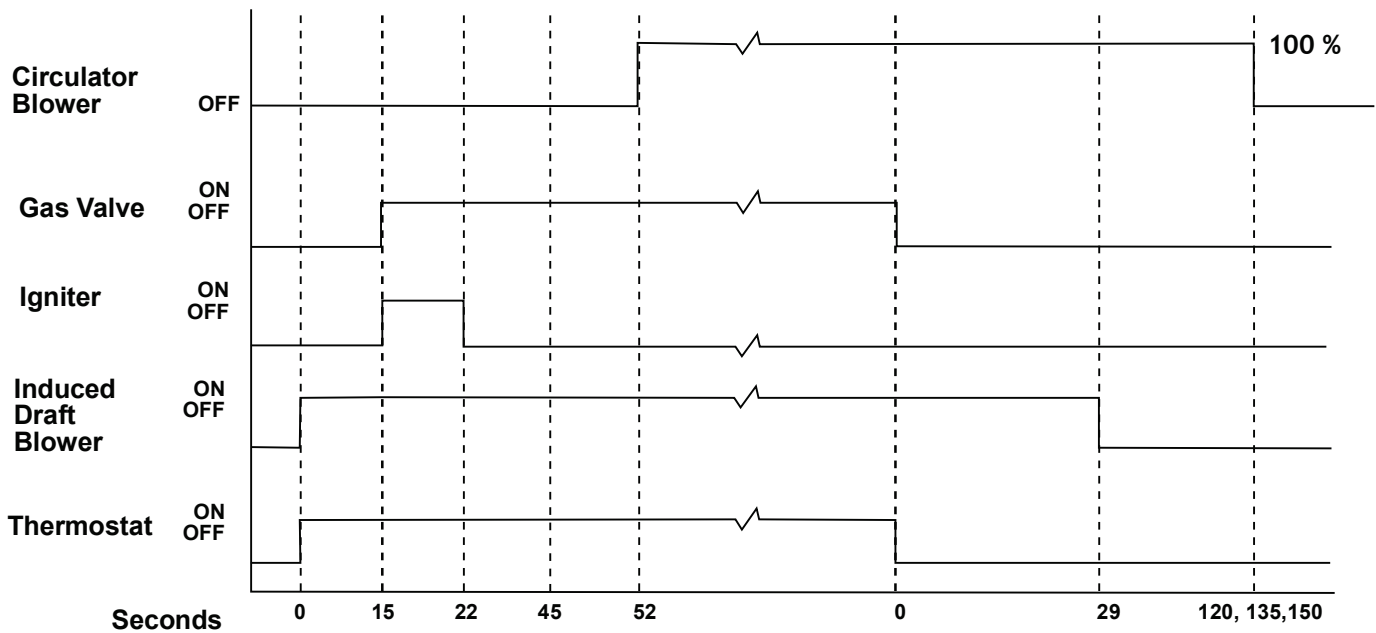

### COOLING TIMING CHART

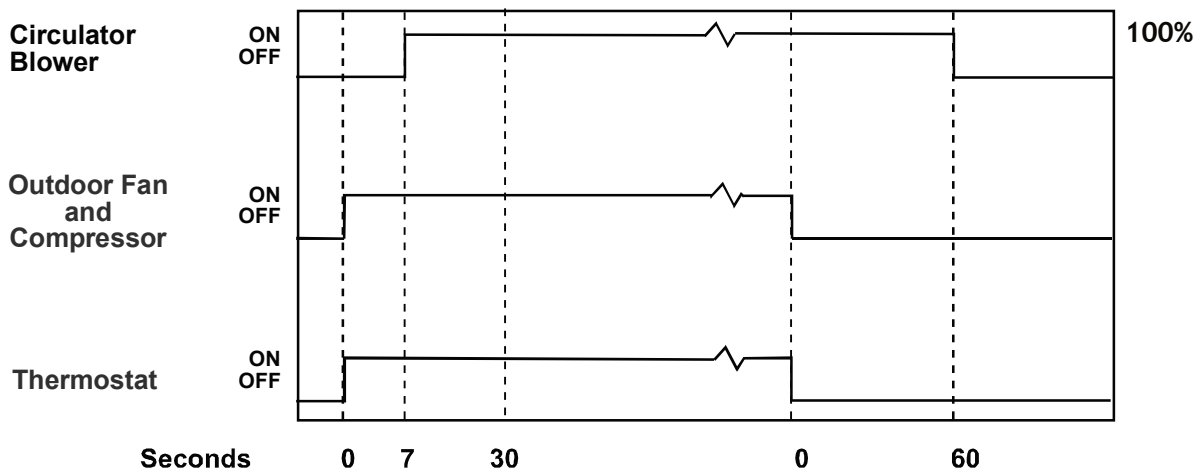

# TROUBLESHOOTING

## IGNITION CONTROL DIAGNOSTIC INDICATOR CHART (TWO-STAGE MODELS ONLY)

Red Light Signal	Refer to Abnormal Heating or Cooling Operation Sections of this Manual
Off	Internal Control Failure
1 Flash	External Lockout
2 Flashes	Pressure Switch Stuck Open
3 Flashes	Pressure Switch Stuck Closed
4 Flashes	Thermal Protection Device Open
5 Flashes	Flame Detected with Gas Valve Closed
6 Flashes	Short Cycle Compressor Delay (Cooling Only)
7 Flashes	Limit Opened Five (5) Times Within The Same Call For Heat
8 Flashes	Indoor/Outdoor Thermostat Open (Cooling Only; Devices Not present On All Models)
9 Flashes	High Pressure/Loss of Charge Switch Open (Cooling Only; Devices Not Present On All Models)
Amber Light Signal	Refer to Abnormal Heating or Cooling Operation Sections of this Manual
Off	No Flame Present
On	Normal Flame
1 Flash	Low Flame Current
2 Flashes	Flame Detected with Gas Valve De-energized.

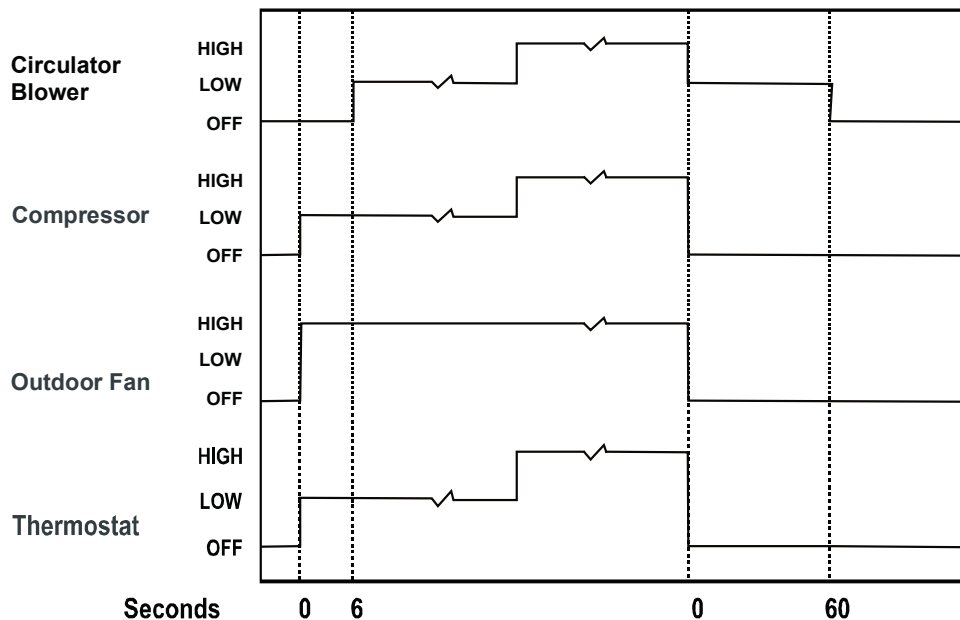
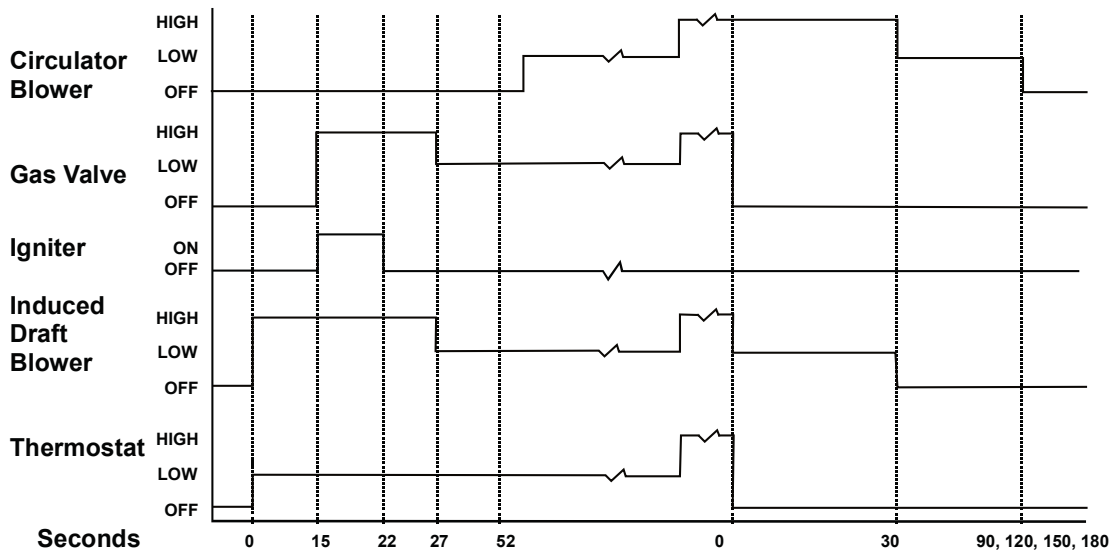

# MAINTENANCE

## MAINTENANCE



### WARNING

**HIGH VOLTAGE!**  
DISCONNECT ALL POWER BEFORE SERVICING OR INSTALLING. MULTIPLE POWER SOURCES MAY BE PRESENT. FAILURE TO DO SO MAY CAUSE PROPERTY DAMAGE, PERSONAL INJURY OR DEATH.



Have the gas heating section of the unit checked at least once a year before the heating season begins, to be sure that the combustion air inlet and flue outlet hoods are not blocked by debris, which would prevent adequate combustion air and a properly operating vent system.

### FILTER REPLACEMENT OR CLEANING

A return air filter is not supplied with this unit; however, there must be a means of filtering all of the return air. The filter(s) may be located in the return air duct(s), or return air filter grille(s). Consult with your installing dealer for the actual location of the return air filter(s) for your unit. Dirty filters are the most common cause of inadequate heating or cooling performance. Filter inspection should be made at least every two months; more often if necessary because of local conditions and usage.

Dirty throwaway filters should be discarded and replaced with a new, clean filter. Dirty permanent filters should be washed with water, thoroughly dried and sprayed with a filter adhesive before being reinstalled (Filter adhesives may be found at many hardware stores). Permanent filters should last several years. However, should one become torn or uncleanable, it should be replaced.

### CABINET FINISH MAINTENANCE

Use a fine grade automotive wax on the cabinet finish to maintain the finish's original high luster. This is especially important in installations with extended periods of direct sunlight.

### CLEAN OUTSIDE COIL (QUALIFIED SERVICER ONLY)

The coil with the outside air flowing over it should be inspected annually and cleaned as frequently as necessary to keep the finned areas free of lint, hair and debris.

### CONDENSER, EVAPORATOR, AND INDUCED DRAFT MOTORS

Bearings on the air circulating blower motor, condenser motor and the combustion fan motor are permanently lubricated. No additional oiling is required.

### FLAME SENSOR (QUALIFIED SERVICER ONLY)

A drop in the flame current can be caused by a nearly invisible coating on the flame sensor. This coating, created by the fuel or combustion air supply, can be removed by carefully cleaning the flame sensor with steel wool. **NOTE:** After cleaning, the microamp signal should be stable and in the range of 4 - 6 microamps DC.

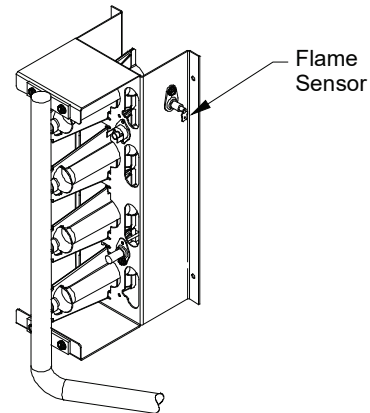

### FLAME SENSOR

### FLUE PASSAGES (QUALIFIED SERVICER ONLY)

At the start of each heating season, inspect and, if necessary, clean the unit flue passage.

### CLEANING FLUE PASSAGES (QUALIFIED SERVICER ONLY)

1. Shut off electric power and gas supply to the unit.
2. Remove burner assembly by disconnecting the gas line and removing the manifold bracket from the partition panel.
3. Remove the flue from the induced draft blower and the collector box cover from the partition panel.
4. The primary heat exchanger tubes can be cleaned using a round wire brush attached to a length of high grade stainless steel cable, such as drain cleanout cable. Attach a variable speed reversible drill to the other end of the spring cable. Slowly rotate the cable with the drill and insert it into one of the primary heat exchanger tubes. While reversing the drill, work the cable in and out several times to obtain sufficient cleaning. Use a large cable for the large tube, and then repeat the operation with a small cable for the smaller tube. Repeat for each tube.
5. When all heat exchanger tubes have been cleaned, replace the parts in the reverse order in which they were removed.
6. To reduce the chances of repeated fouling of the heat exchanger, perform the steps listed in "Startup, Adjustments, and Checks".

### MAIN BURNER FLAME (QUALIFIED SERVICER ONLY)

Flames should be stable, soft and blue (dust may cause orange tips but must not be yellow). The flames must extend directly outward from the burner without curling, floating or lifting off.

# MAINTENANCE

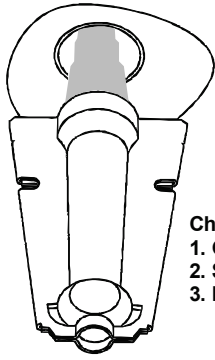

Check the burner flames for:  
1. Good adjustment  
2. Stable, soft and blue  
3. Not curling, floating, or lifting off.

**BURNER FLAME**



## WARNING

**TO AVOID PERSONAL INJURY OR DEATH DUE TO ELECTRICAL SHOCK, DO NOT REMOVE ANY INTERNAL COMPARTMENT COVERS OR ATTEMPT ANY ADJUSTMENT. CONTACT A QUALIFIED SERVICER AT ONCE IF AN ABNORMAL FLAME SHOULD DEVELOP.**

At least once a year, prior to or during the heating season, make a visual check of the burner flames.

**NOTE: This will involve removing and reinstalling the heat exchanger door on the unit, which is held by two screws. If you are uncertain about your ability to do this, contact a qualified servicer.**

If a strong wind is blowing, it may alter the airflow pattern within the unit enough that an inspection of the burner flames is not possible.

## CLEANING BURNERS

1. Shut off electric power and gas supply to the unit.
2. Remove the screws securing the manifold to the burner retention bracket. Remove the manifold and rotate each burner counterclockwise to remove.

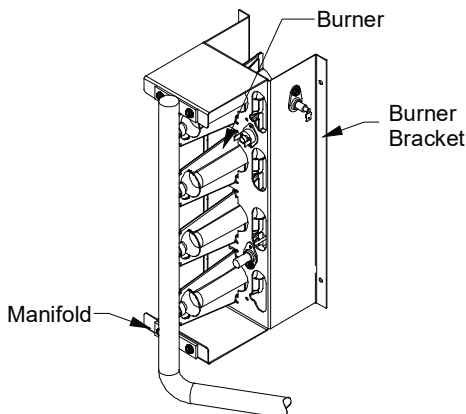

**MANIFOLD ASSEMBLY**

3. Remove the burners.
4. Use a bottle brush to clean burner insert and inside of the burners.
5. Replace burners and manifold, inspect the burner assembly for proper seating of burners in retention slots.
6. Reconnect electrical power and gas supply.



## CAUTION

**LABEL ALL WIRES PRIOR TO DISCONNECTION WHEN SERVICING CONTROLS. WIRING ERRORS CAN CAUSE IMPROPER AND DANGEROUS OPERATION.**



## CAUTION

**ALWAYS VERIFY PROPER OPERATION AFTER SERVICING.**

For further information on the yearly inspection, consult the User Manual. It is recommended that a qualified servicer inspect and service the unit at least once each year.

Turn the unit on at the thermostat. Wait a few minutes, since any dislodged dust will alter the normal flame appearance. Flames should be predominantly blue and directed into the tubes. They should not be yellow. They should extend directly outward from the burner ports without curling downward, floating or lifting off the ports.

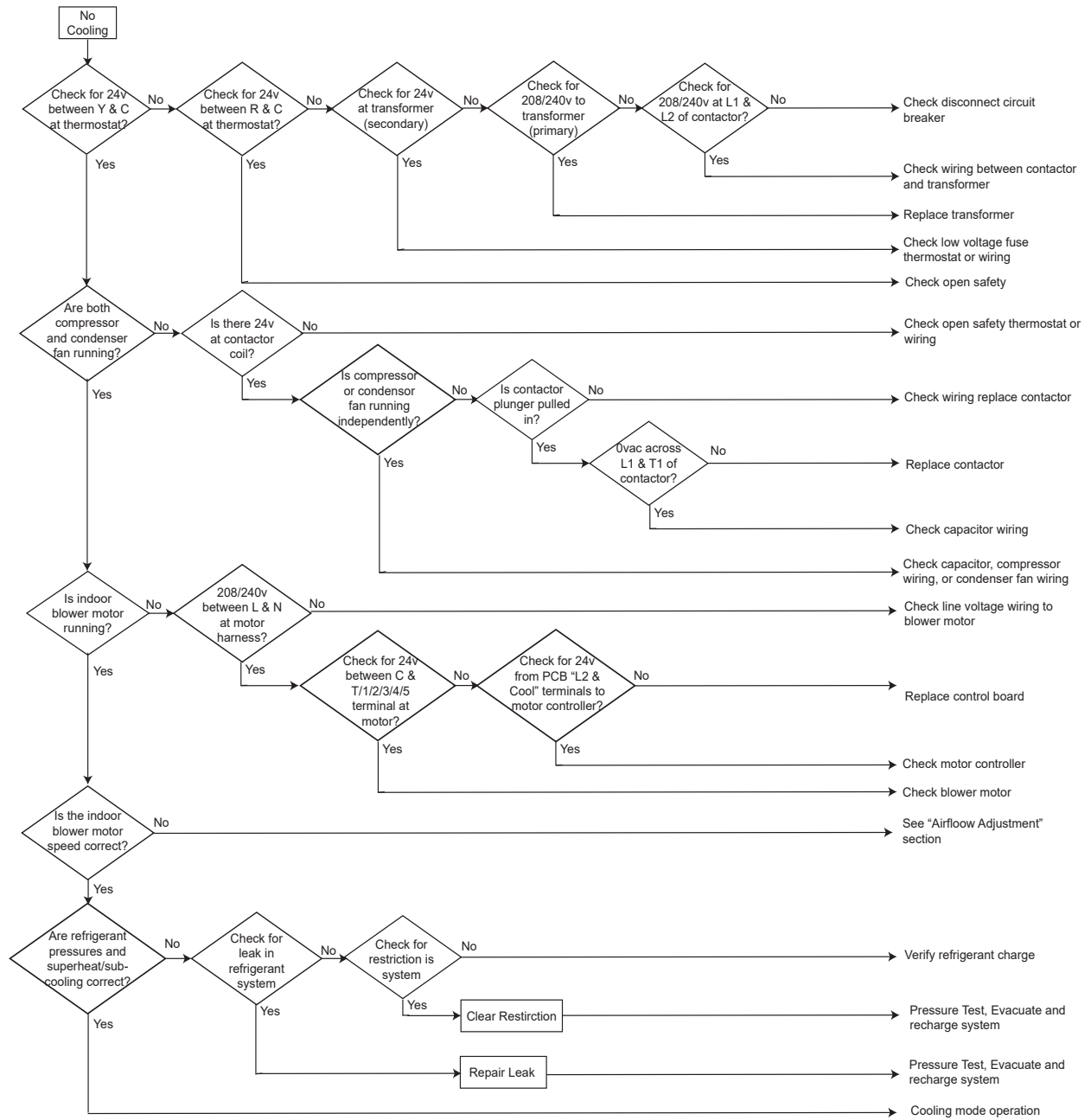



# Troubleshooting

# Gas Pack - Cooling (2 Stage)

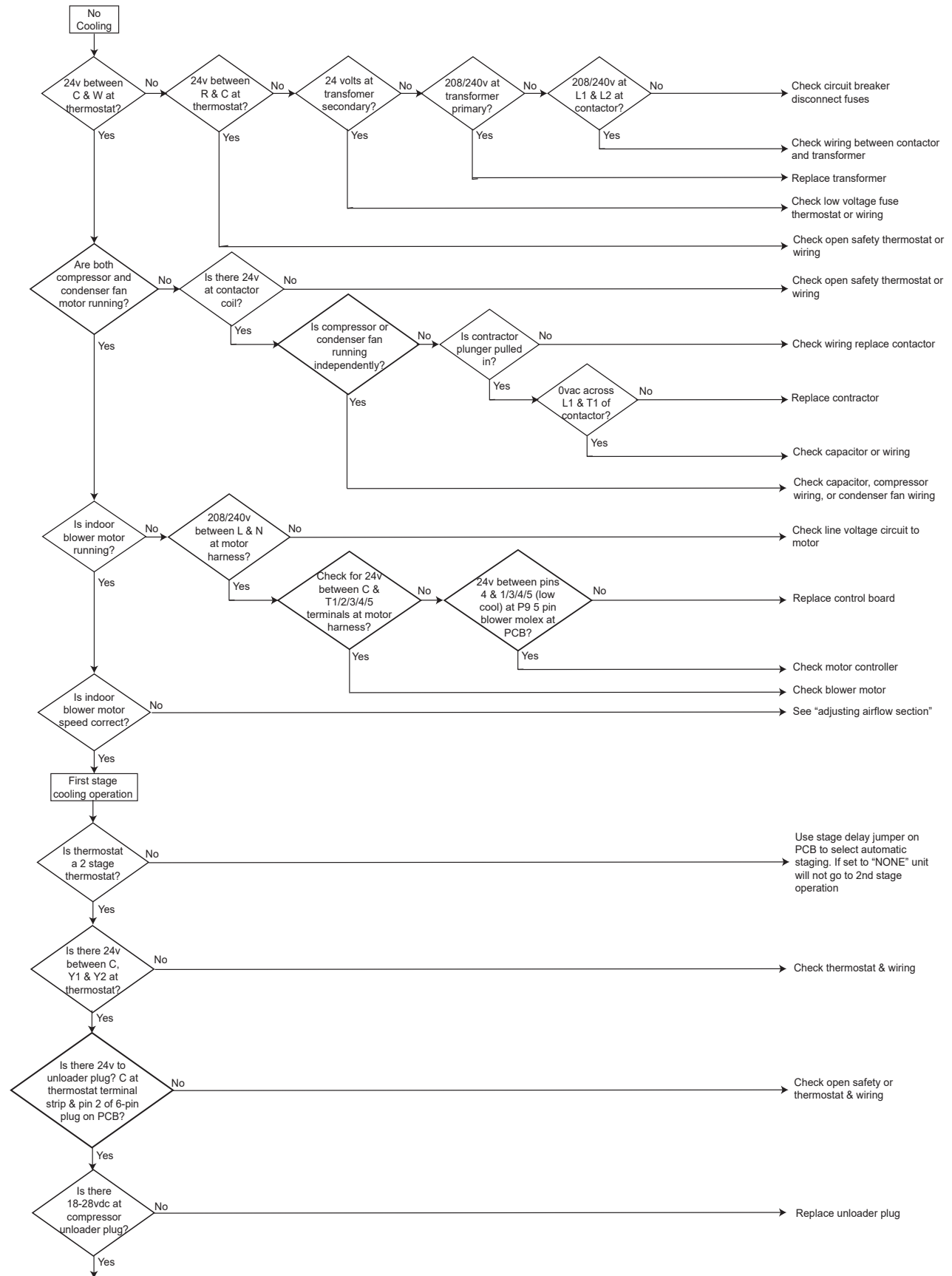

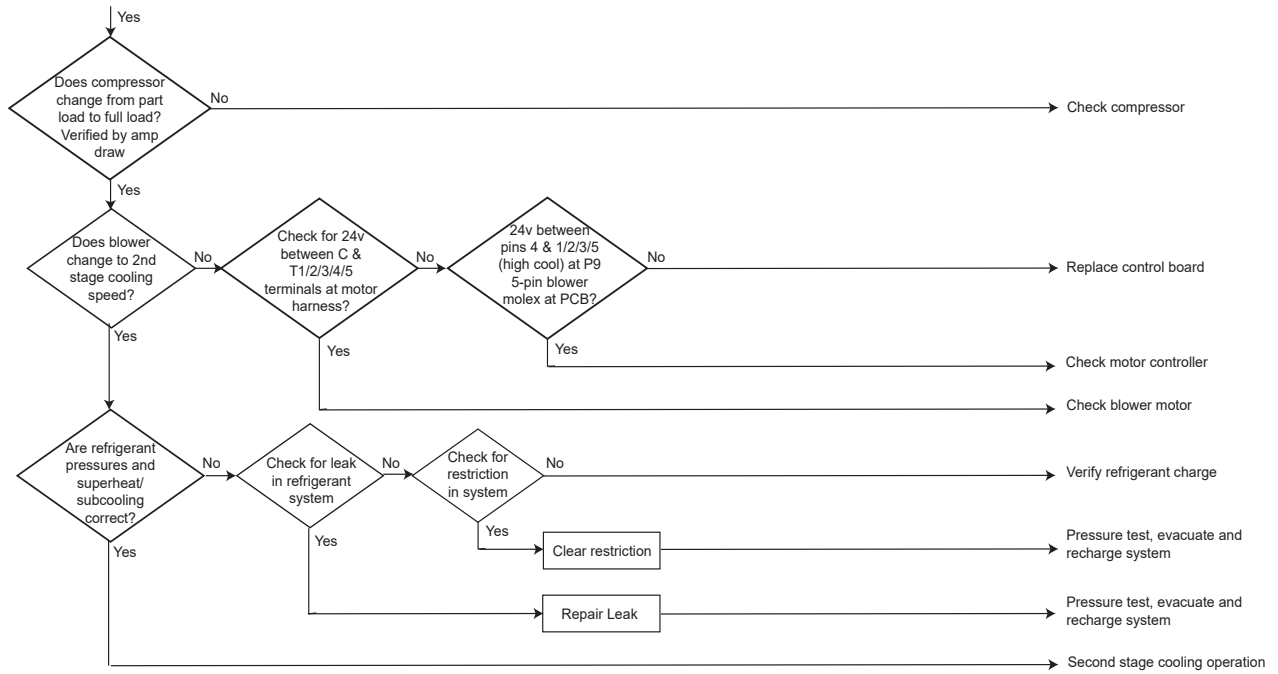

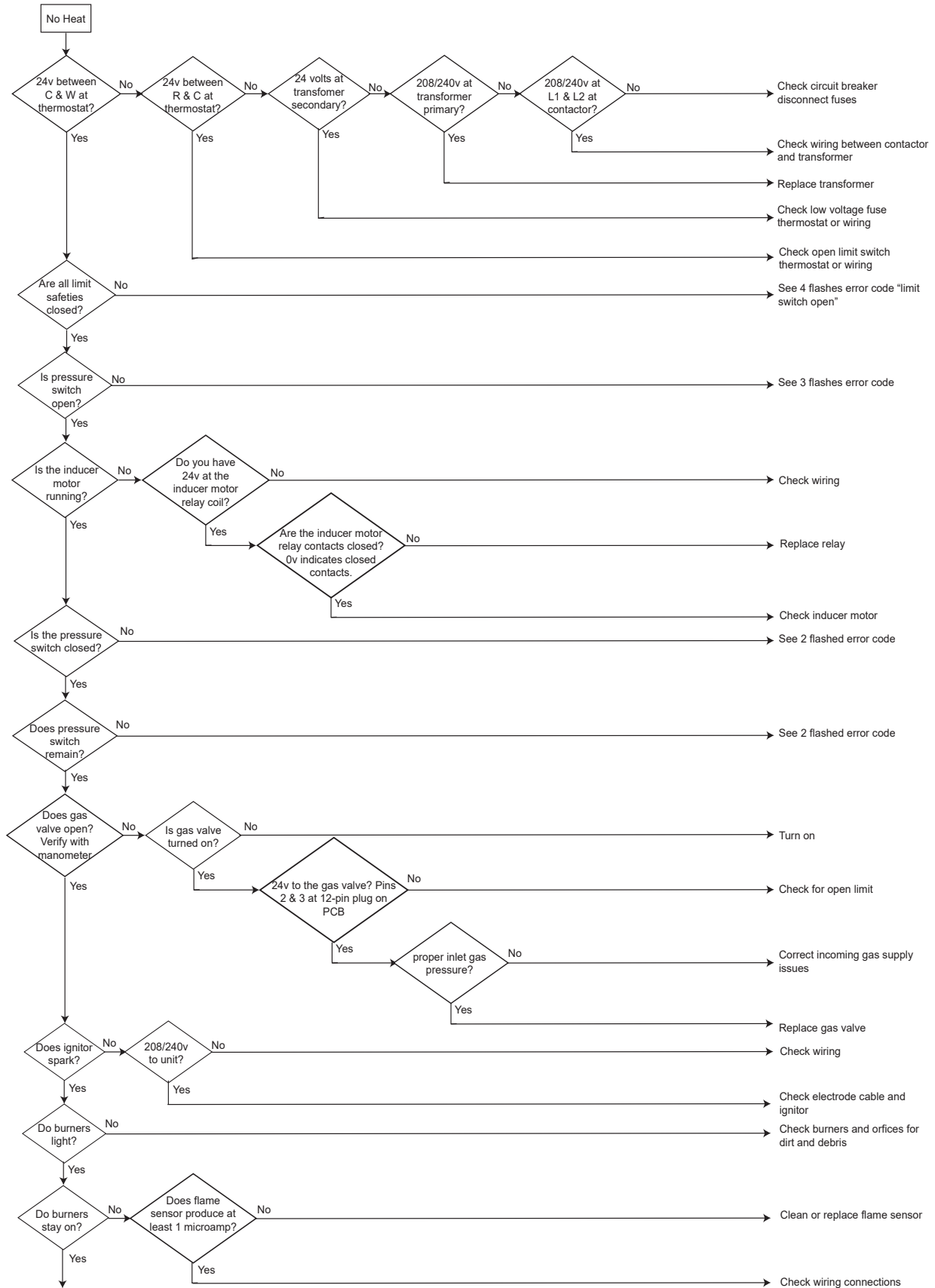

# Troubleshooting

# Gas Pack - Heating (1 Stage)

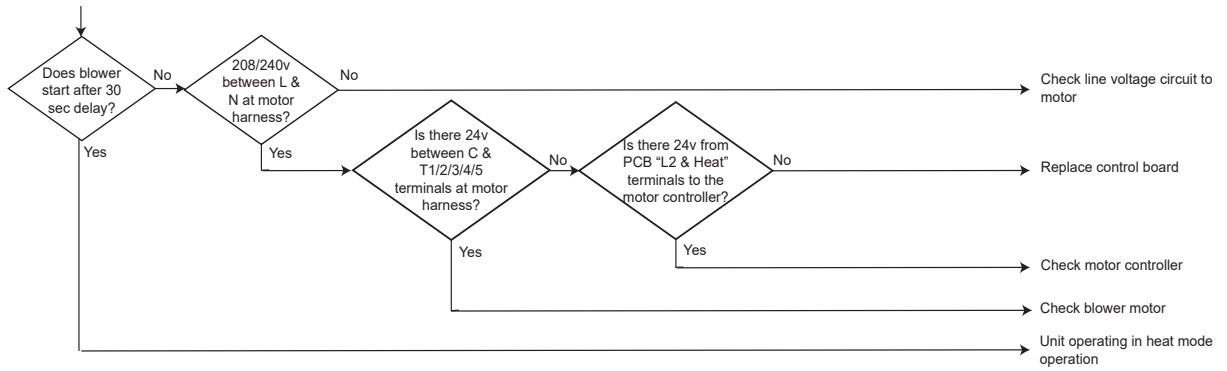

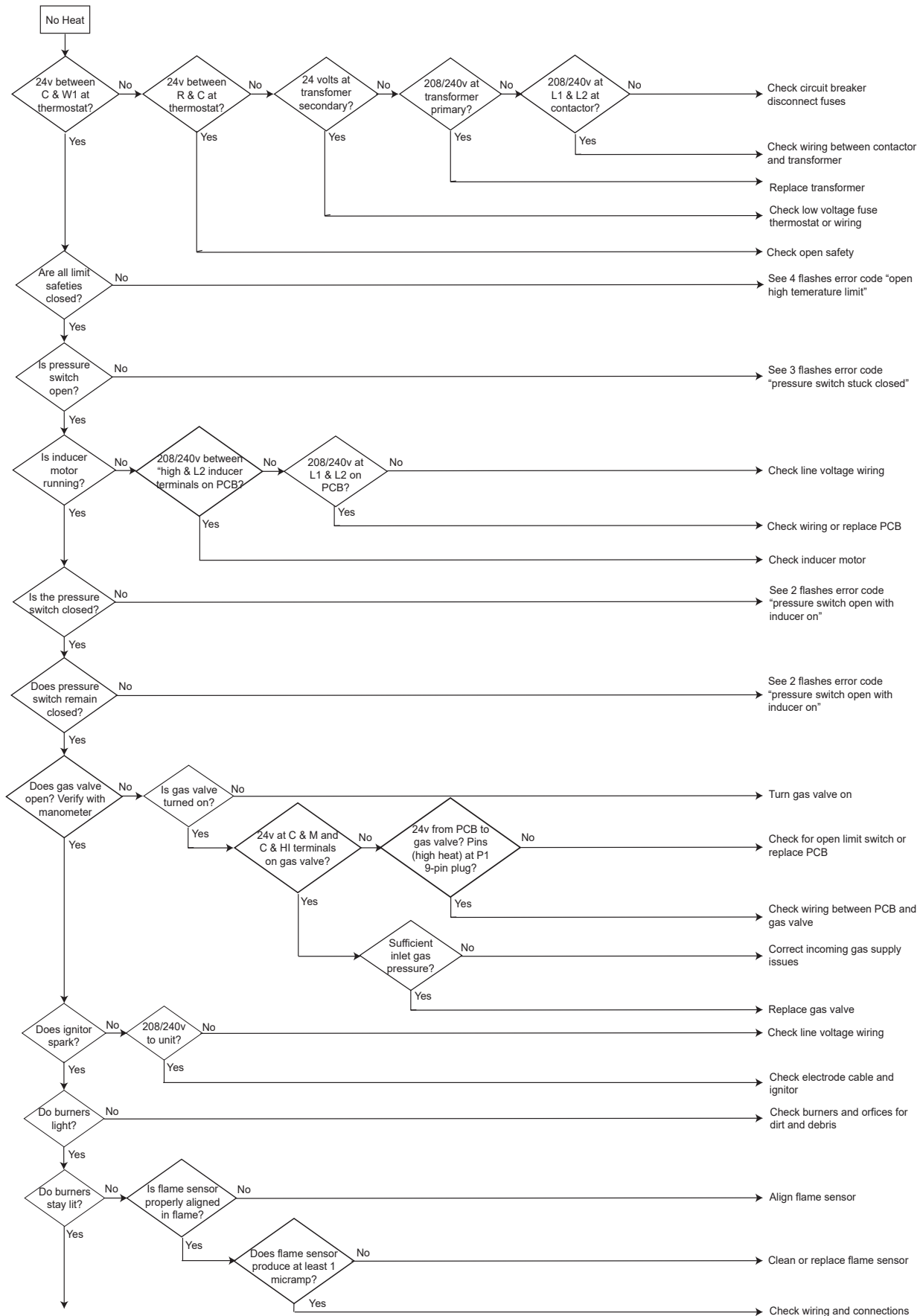



# Troubleshooting

# Gas Pack - Heating (2 Stage)

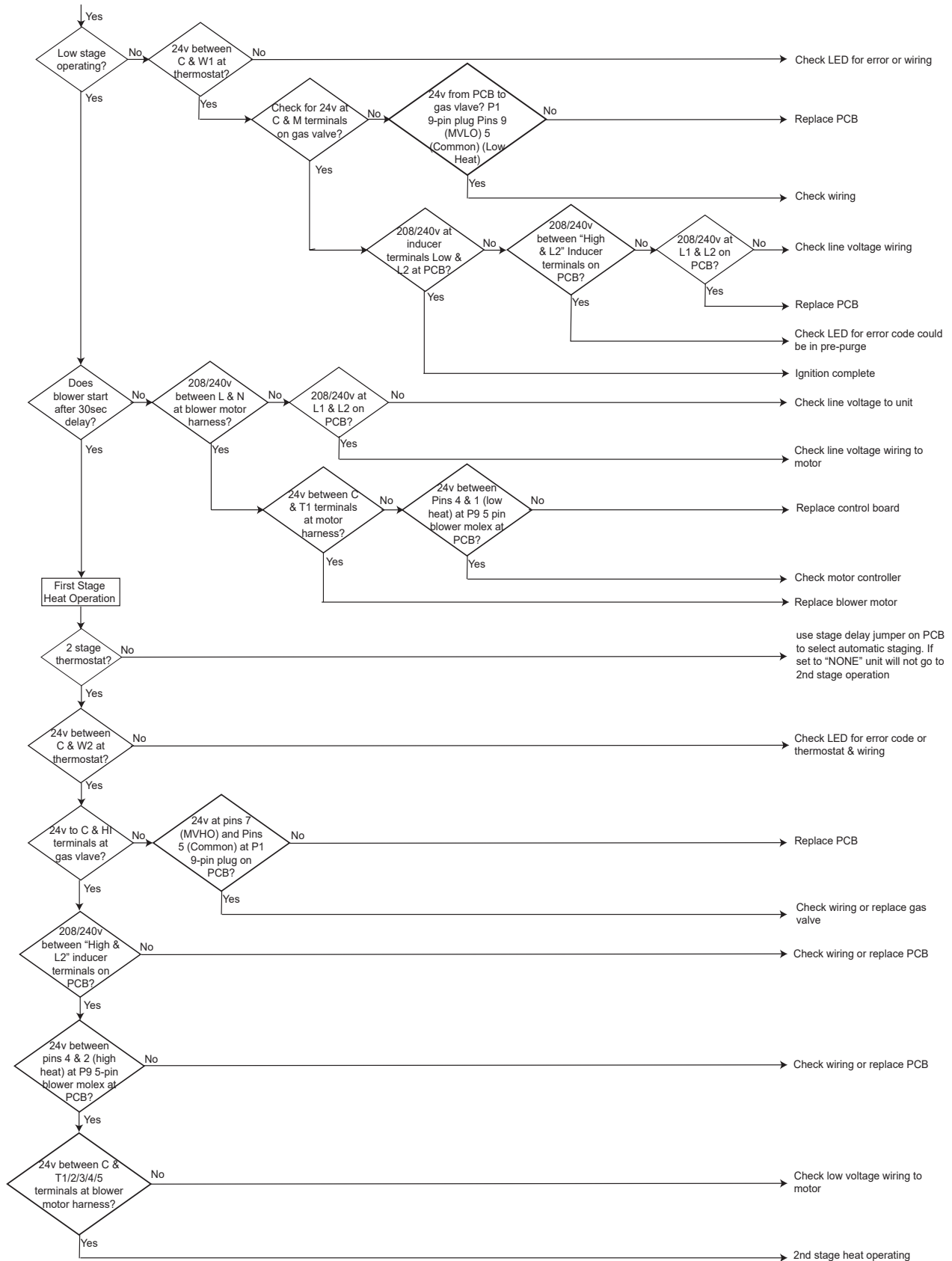

# Troubleshooting

# Gas Electric (Single Stage) 1 Flashes (Red)

**Error Code:**  
1 Flashes (Red) - Ignition Lockout

**Applicable Models:**  
GPGM3\*\*\*\*41  
APGM3\*\*\*\*41

**Method of Error Detection:**  
3 Failed Ignition Trials

**Error Decision Conditions:**  
An external lockout occurs if the integrated ignition control determines that a measurable combustion cannot be established within three (3) consecutive ignition attempts. If flame is not established within the seven (7) second trial for ignition, the gas valve is deenergized, 15 second inter-purge cycle is completed, and ignition is reattempted. The control will repeat this routine three times if a measurable combustion is not established. The control will then shut off the induced draft blower and go into a lockout state.

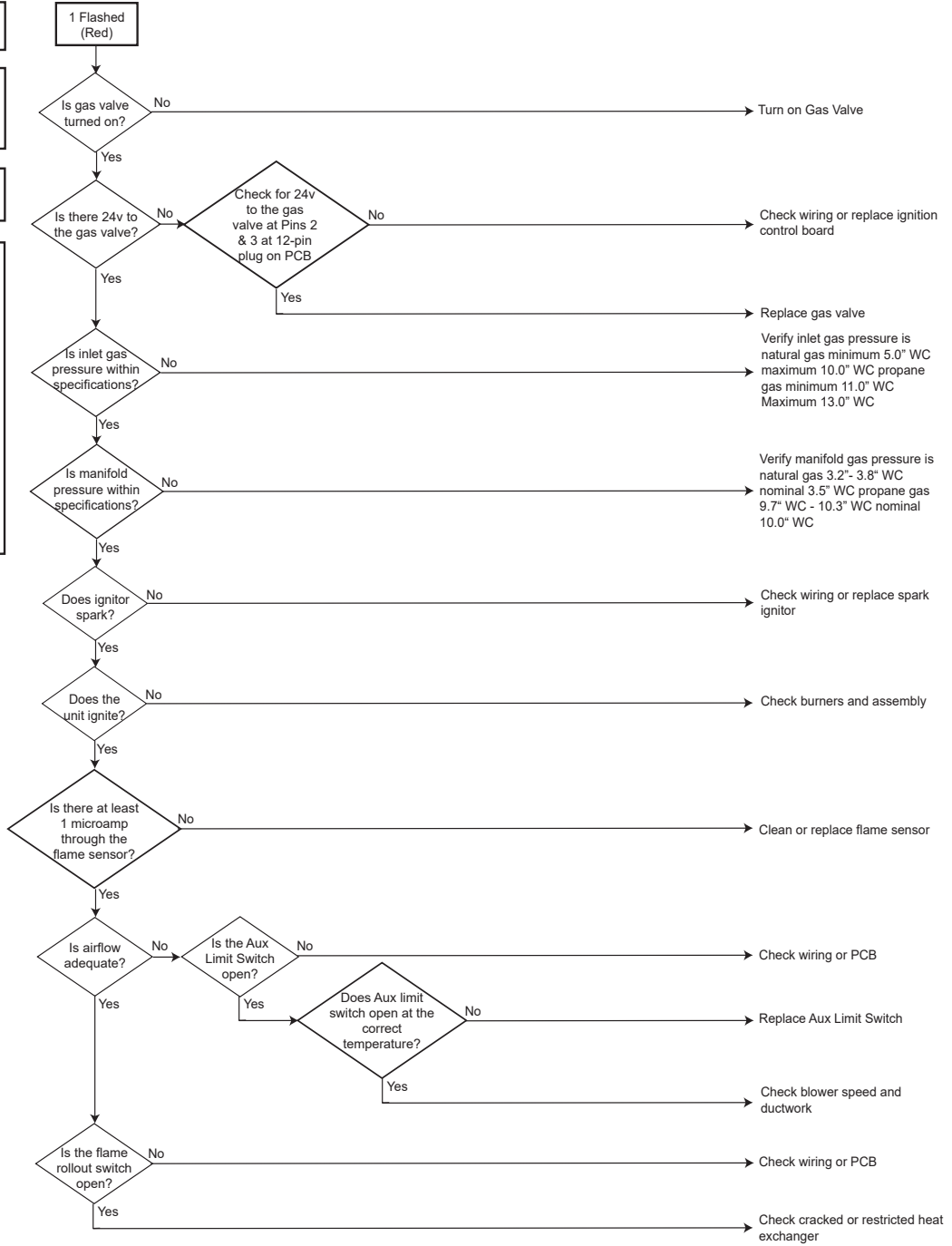

# Troubleshooting

# Gas Electric (Single Stage) 2 Flashes (Red)

**Error Code:**  
2 Flashes (Red) - Pressure switch stuck open with inducer running

**Applicable Models:**  
GPGM3\*\*\*\*41  
APGM3\*\*\*\*41

**Method of Error Detection:**  
Pressure switch is open with inducer motor running

**Error Decision Conditions:**  
If the control senses an open pressure switch during the pre-purge cycle, the induced draft blower only will be energized. If the pressure switch opens after ignition has begun the gas valve is deenergized, the circulator blower heat off cycle begins, and the induced draft blower remains on. The diagnostic fault code is two flashes.

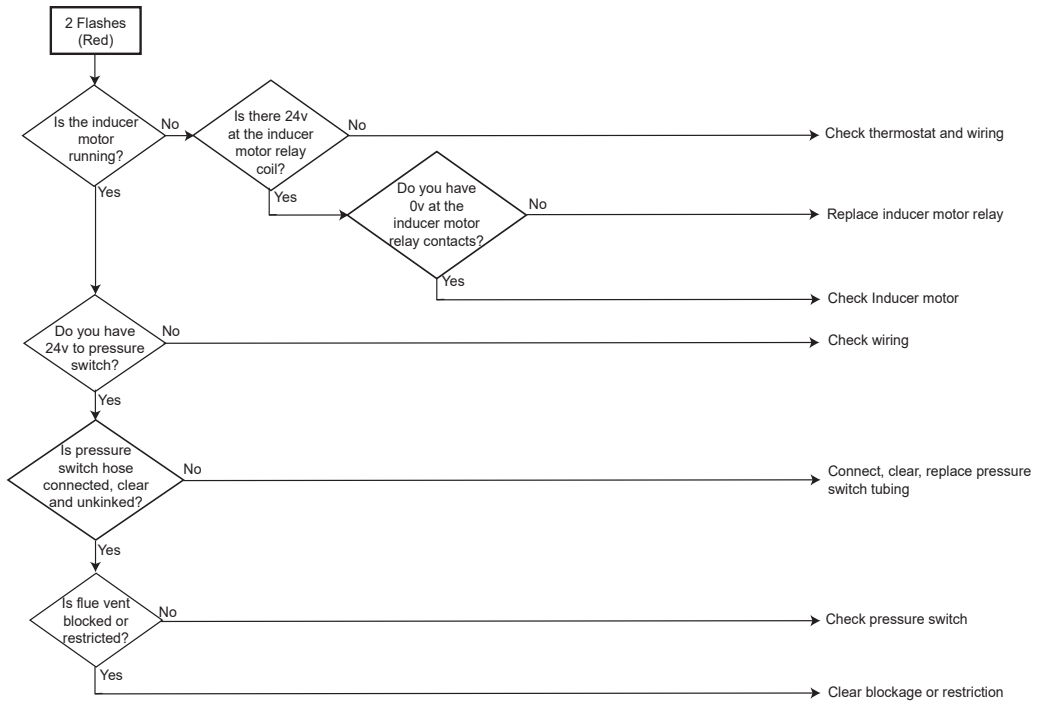

# Troubleshooting

# Gas Electric (Single Stage) 3 Flashes (Red)

**Error Code:**  
3 Flashes (Red) - Pressure Switch Stuck Closed

**Applicable Models:**  
GPM3\*\*\*\*41  
APGM3\*\*\*\*41

**Method of Error Detection:**  
Pressure switch is closed with inducer motor off

**Error Decision Conditions:**  
If the control sense the pressure switch is closed before the inducer is energized, the inducer will remain off and the control will flash an error code of 3 flash on the LED until the pressure switch opens.

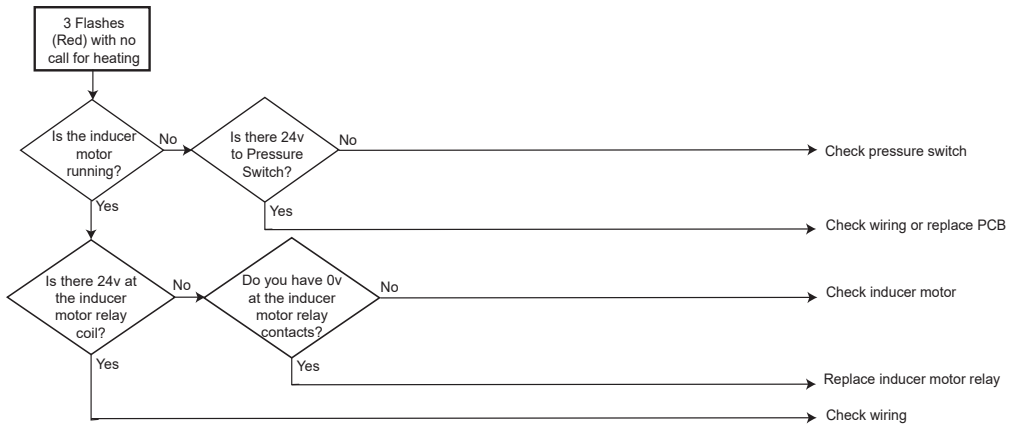

# Troubleshooting

# Gas Electric (Single Stage) 4 Flashes (Red)

**Error Code:**  
4 Flashes (Red) - Open main limit switch

**Applicable Models:**  
GPGM3\*\*\*\*41  
APGM3\*\*\*\*41

**Method of Error Detection:**  
Open thermal protection device (Primary Limit, Auxiliary Limit, Flame Roll Out)

**Error Decision Conditions:**  
If the control senses that a limit switch has opened, the gas valve is immediately deenergized, the induced draft and air circulating blowers are energized. The induced draft and air circulator blowers remain energized until the limit switch recloses. The diagnostic fault code for an open limit is four (4) flashes.

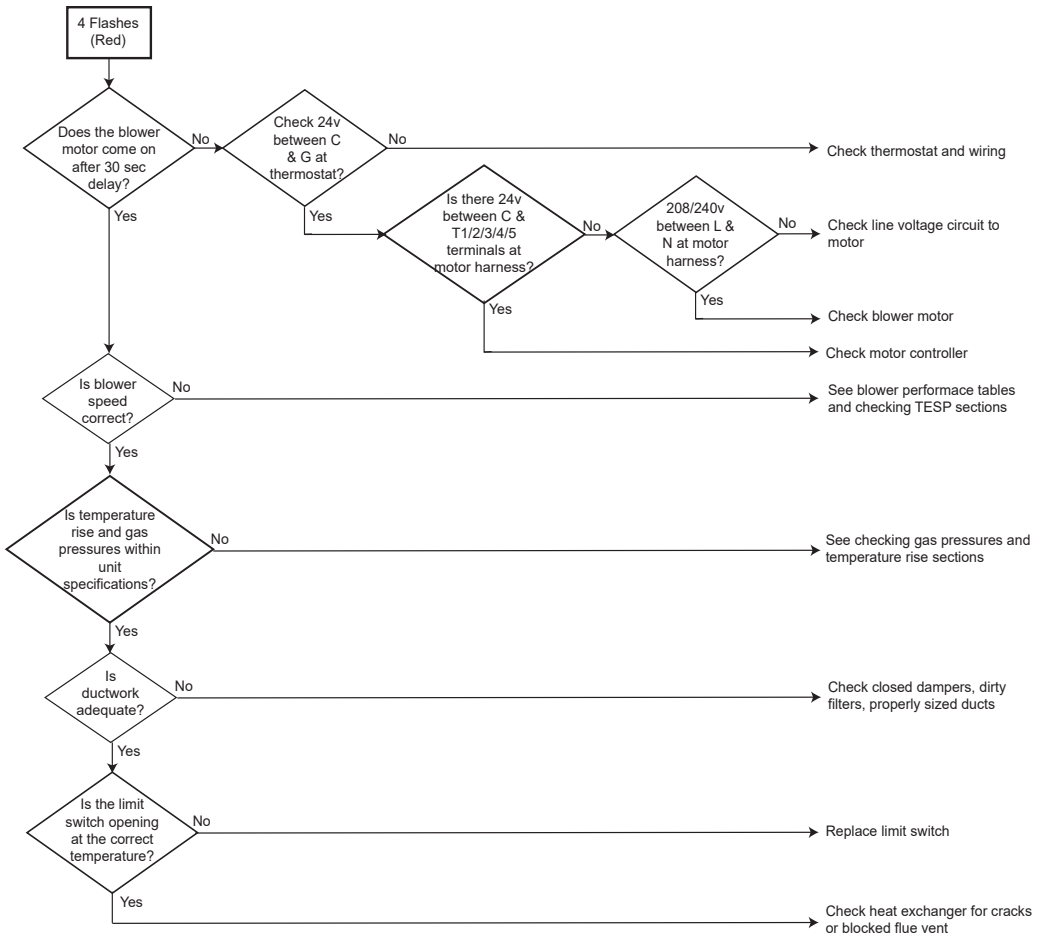



# Troubleshooting

# Gas Electric (Single Stage) 5 Flashes (Red)

**Error Code:**  
5 Flashes (Red) - Flame detected with gas valve closed

**Applicable Models:**  
GPGM3\*\*\*\*41  
APGM3\*\*\*\*41

**Method of Error Detection:**  
Flame detected with gas valve de-energized

**Error Decision Conditions:**  
The control senses a flame present when the gas valve is off. If flame is detected with the gas valve de-energized, the combustion and air circulator blowers are energized. The diagnostic fault code is five (5) flashes for this condition.

5 Flashes (Red) with no call for heating

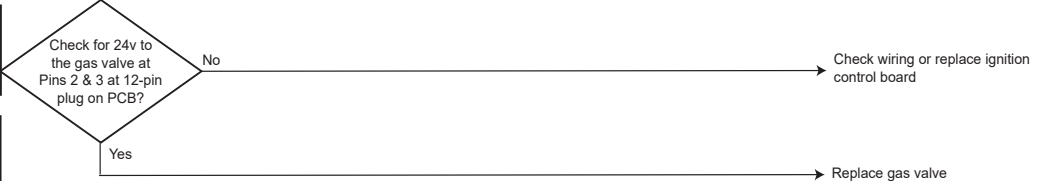

# Troubleshooting

# Gas Electric (Two Stage) 1 Flash (Amber)

**Error Code:**  
1 Flashes (Amber) - Low flame sense

**Applicable Models:**  
GPGM3(61)\*\*\*\*41  
APGM3(61)\*\*\*\*41  
GPGM5\*\*\*\*41  
APGM5\*\*\*\*41

**Method of Error Detection:**  
Flame signal drops below a predetermined value

**Error Decision Conditions:**  
Control senses less than 1 microamp current during call for heating

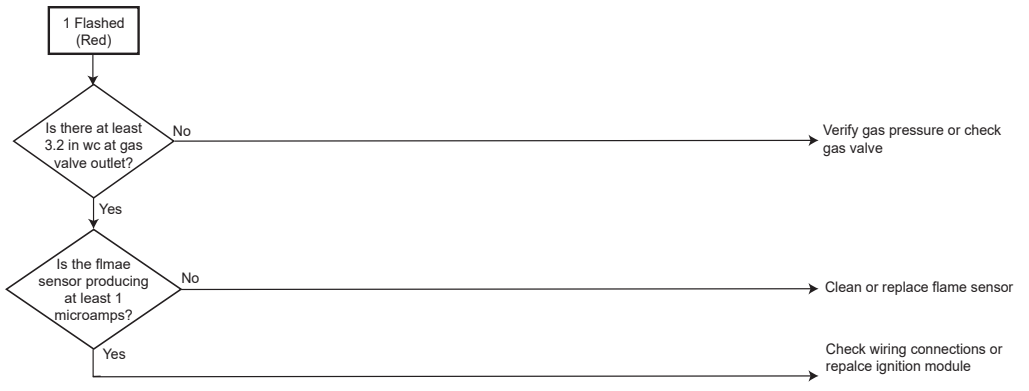

# Troubleshooting

# Gas Electric (Two Stage) 1 Flashes (Red)

**Error Code:**  
1 Flashes (Red) - Ignition Lockout

**Applicable Models:**  
GPGM3(61)\*\*\*\*41  
APGM3(61)\*\*\*\*41  
GPGM5\*\*\*\*41  
APGM5\*\*\*\*41

**Method of Error Detection:**  
3 Failed Ignition Trials

**Error Decision Conditions:**  
An external lockout occurs if the integrated ignition control determines that a measurable combustion cannot be established within three (3) consecutive ignition attempts. If flame is not established within the seven (7) second trial for ignition, the gas valve is deenergized, 15 second inter-purge cycle is completed, and ignition is reattempted. The control will repeat this routine three times if a measurable combustion is not established. The control will then shut off the induced draft blower and go into a lockout state.

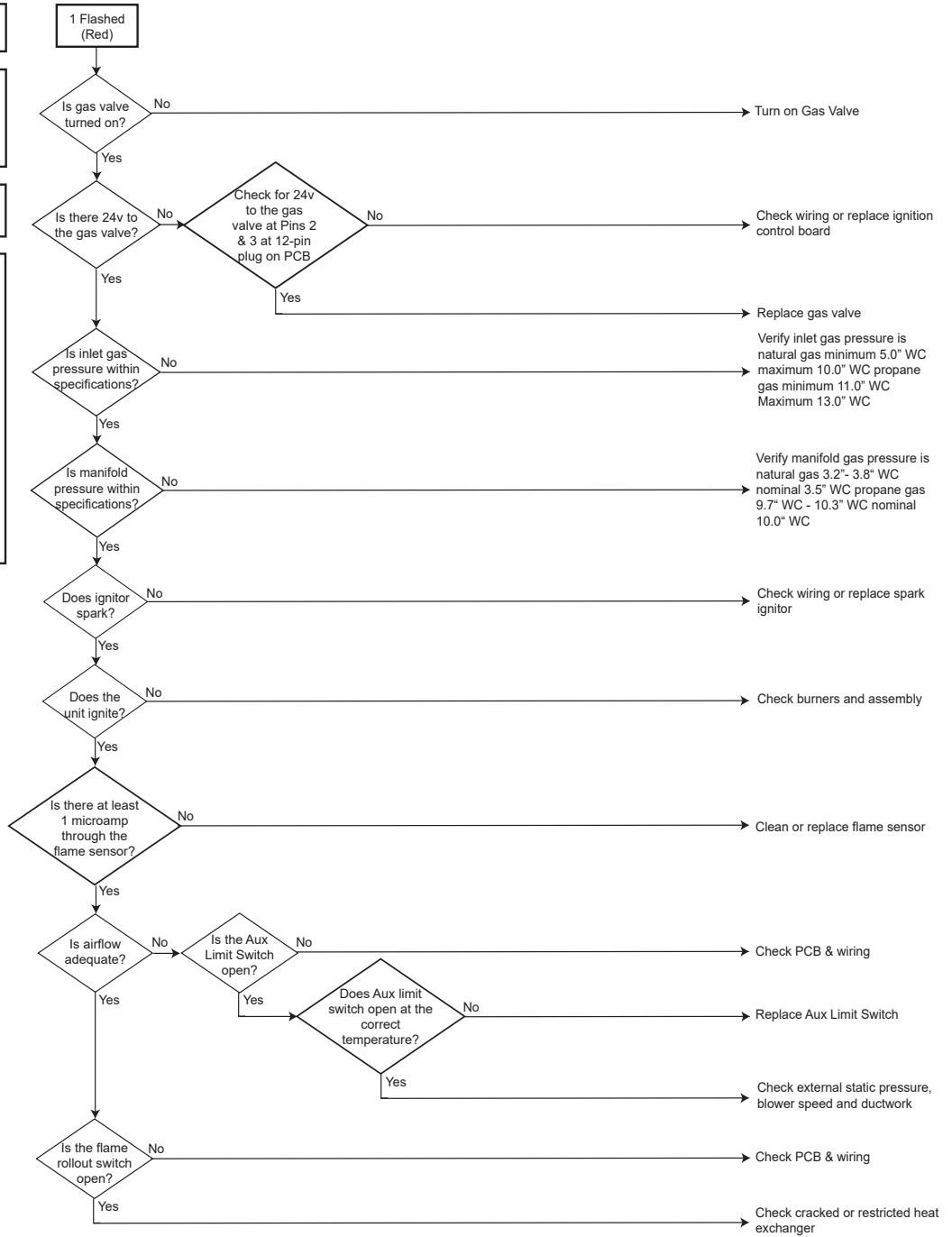

# Troubleshooting

# Gas Electric (Two Stage) 2 Flashes (Red)

**Error Code:**  
2 Flashes (Red) - Pressure switch stuck open with inducer running

**Applicable Models:**  
GPGM3(61)\*\*\*\*41  
APGM3(61)\*\*\*\*41  
GPGM5\*\*\*\*41  
APGM5\*\*\*\*41

**Method of Error Detection:**  
Pressure switch is open with inducer motor running

**Error Decision Conditions:**  
If the control senses an open pressure switch during the pre-purge cycle, the induced draft blower only will be energized. If the pressure switch opens after ignition has begun the gas valve is deenergized, the circulator blower heat off cycle begins, and the induced draft blower remains on. The diagnostic fault code is two flashes.

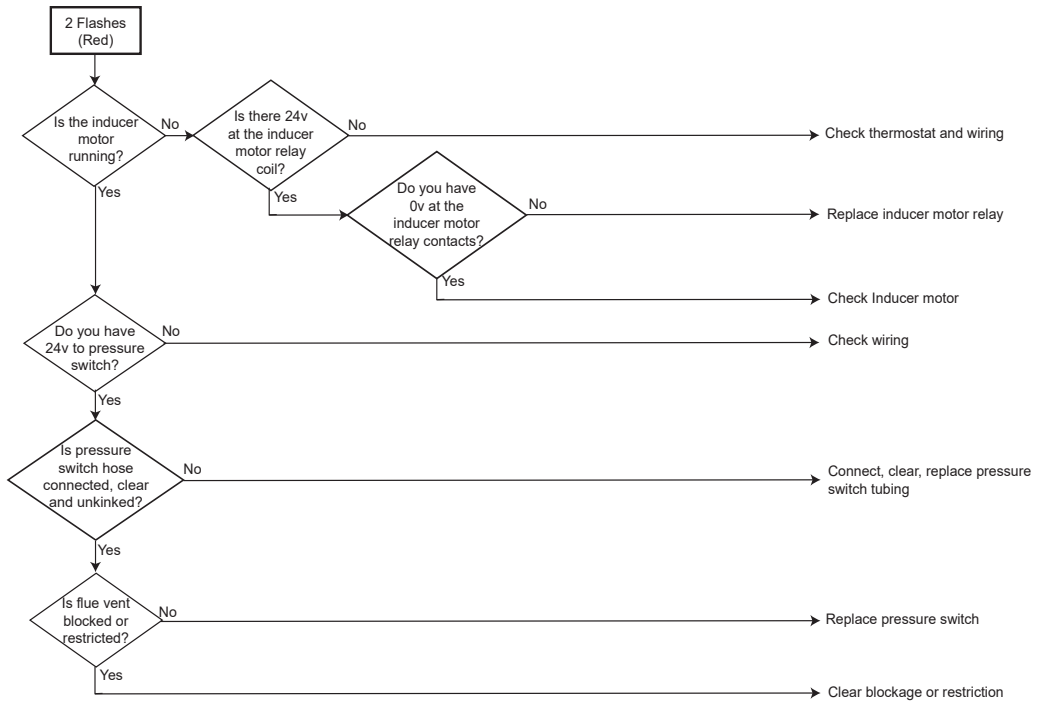

# Troubleshooting

# Gas Electric (Two Stage) 3 Flashes (Red)

**Error Code:**  
3 Flashes (Red) - Pressure Switch Stuck Closed

**Applicable Models:**  
GPGM3(61)\*\*\*\*41  
APGM3(61)\*\*\*\*41  
GPGM5\*\*\*\*41  
APGM5\*\*\*\*41

**Method of Error Detection:**  
Pressure switch is closed with inducer motor off

**Error Decision Conditions:**  
If the control sense the pressure switch is closed before the inducer is energized, the inducer will remain off and the control will flash an error code of 3 flash on the LED until the pressure switch opens.

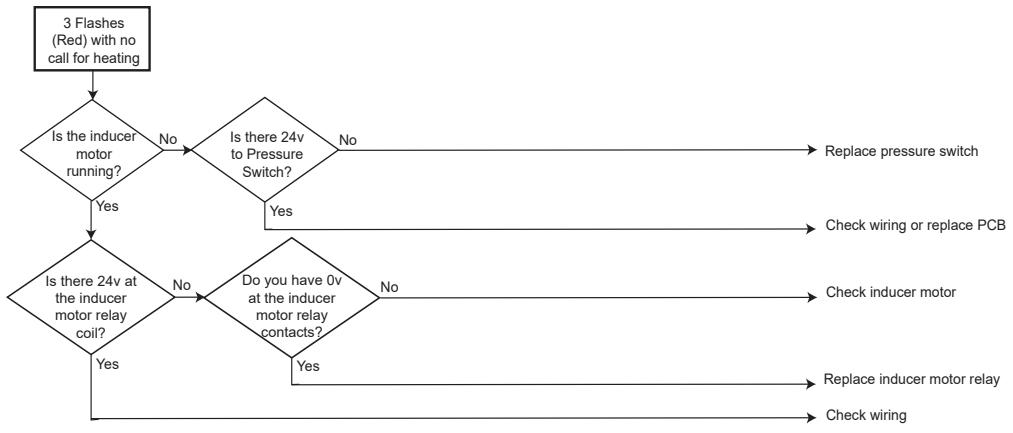

# Troubleshooting

# Gas Electric (Two Stage) 4 Flashes (Red)

**Error Code:**  
4 Flashes (Red) - Open high temperature limit switch (Primary limit, Aux Limit, Flame rollout)

**Applicable Models:**  
GPGM3(61)\*\*\*\*41  
APGM3(61)\*\*\*\*41  
GPGM5\*\*\*\*41  
APGM5\*\*\*\*41

**Method of Error Detection:**  
Open thermal protection device

**Error Decision Conditions:**  
If the control senses that a limit switch has opened, the gas valve is immediately deenergized, the induced draft and air circulating blowers are energized. The induced draft and air circulator blowers remain energized until the limit switch recloses. The diagnostic fault code for an open limit is four (4) flashes.

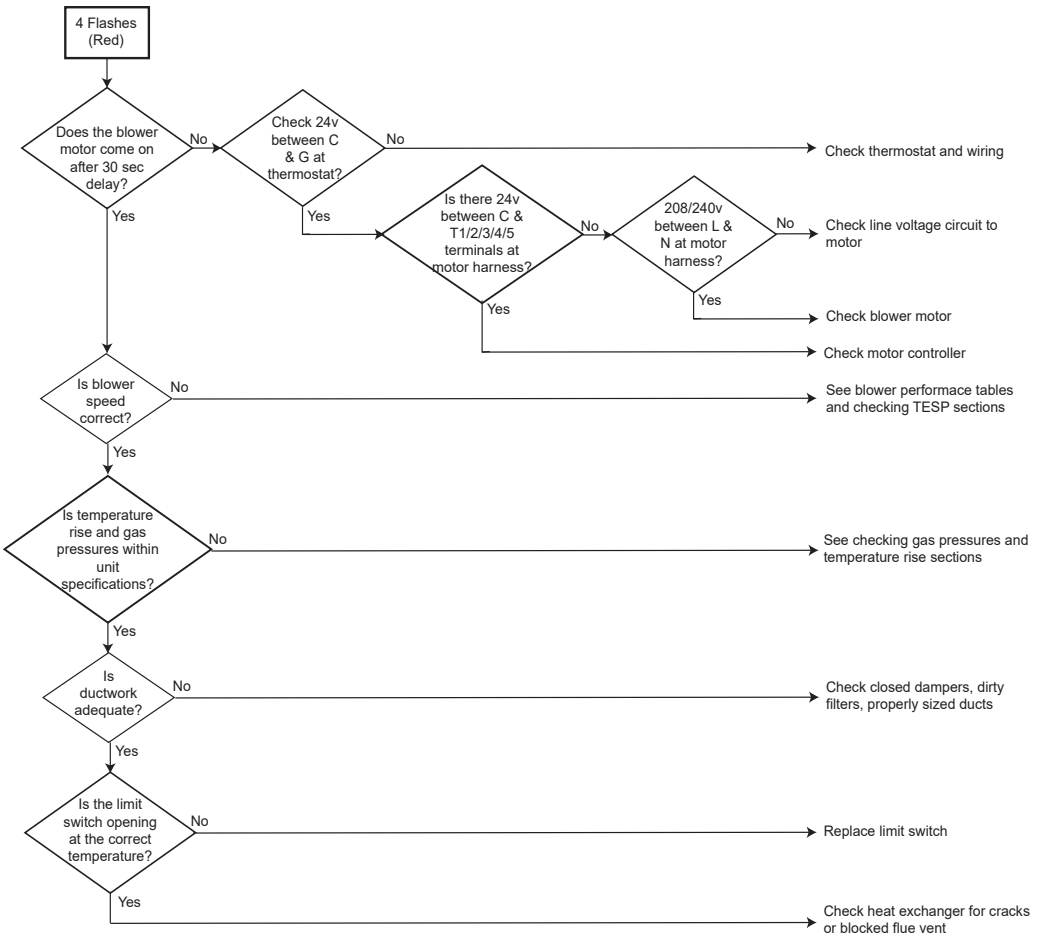



# Troubleshooting

# Gas Electric (Two Stage) 5 Flashes (Red)

**Error Code:**  
5 Flashes (Red) - Flame detected with no call for heat

**Applicable Models:**  
GPGM3(61)\*\*\*\*41  
APGM3(61)\*\*\*\*41  
GPGM5\*\*\*\*41  
APGM5\*\*\*\*41

**Method of Error Detection:**  
Flame detected with gas valve de-energized

**Error Decision Conditions:**  
If flame is detected with the gas valve de-energized, the combustion and air circulator blowers are energized. The diagnostic fault code is five (5) flashes for this condition.

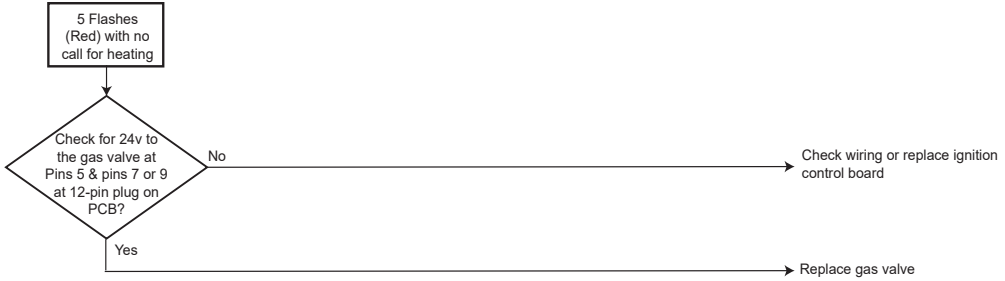

# Troubleshooting

# Gas Electric (Two Stage) 7 Flashes (Red)

**Error Code:**  
7 Flashes (Red) - Limit switch has tripped too many times (Primary Limit, Aux limit, Flame rollout)

**Applicable Models:**  
GPM3(61)\*\*\*\*41  
APGM3(61)\*\*\*\*41  
GPM5\*\*\*\*41  
APGM5\*\*\*\*41

**Method of Error Detection:**  
A limit switch has tripped 5 times in same heating cycle

**Error Decision Conditions:**  
If the control senses that a limit switch has opened 5 times within the same call for heat, the gas valve is immediately deenergized, the induced draft and air circulating blowers are energized. The induced draft and air circulator blowers remain energized until the limit switch recloses. The diagnostic fault code for Limit Switch Opened 5 times in the same call for heat is four (7) flashes.

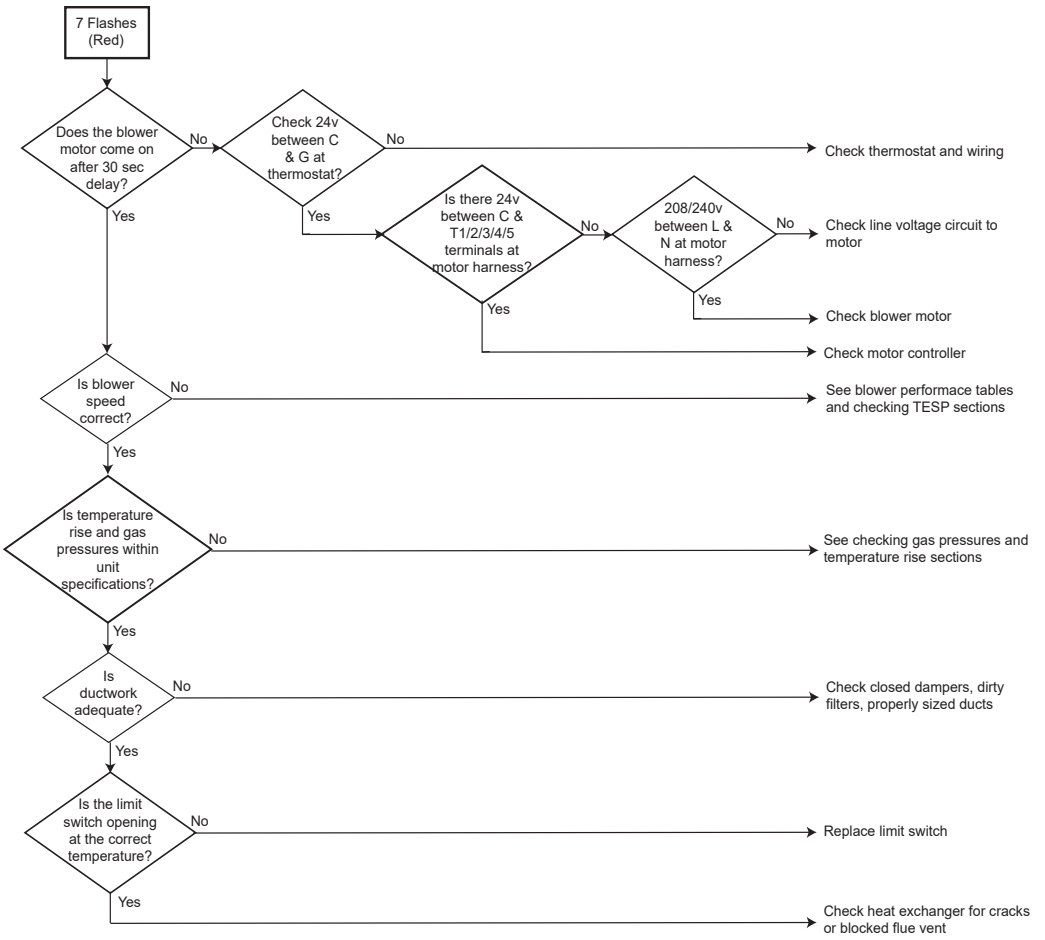



# WIRING DIAGRAMS

**HIGH VOLTAGE!**  
 DISCONNECT ALL POWER BEFORE SERVICING OR INSTALLING THIS UNIT. MULTIPLE POWER SOURCES MAY BE PRESENT. FAILURE TO DO SO MAY CAUSE PROPERTY DAMAGE, PERSONAL INJURY OR DEATH.

**WARNING**

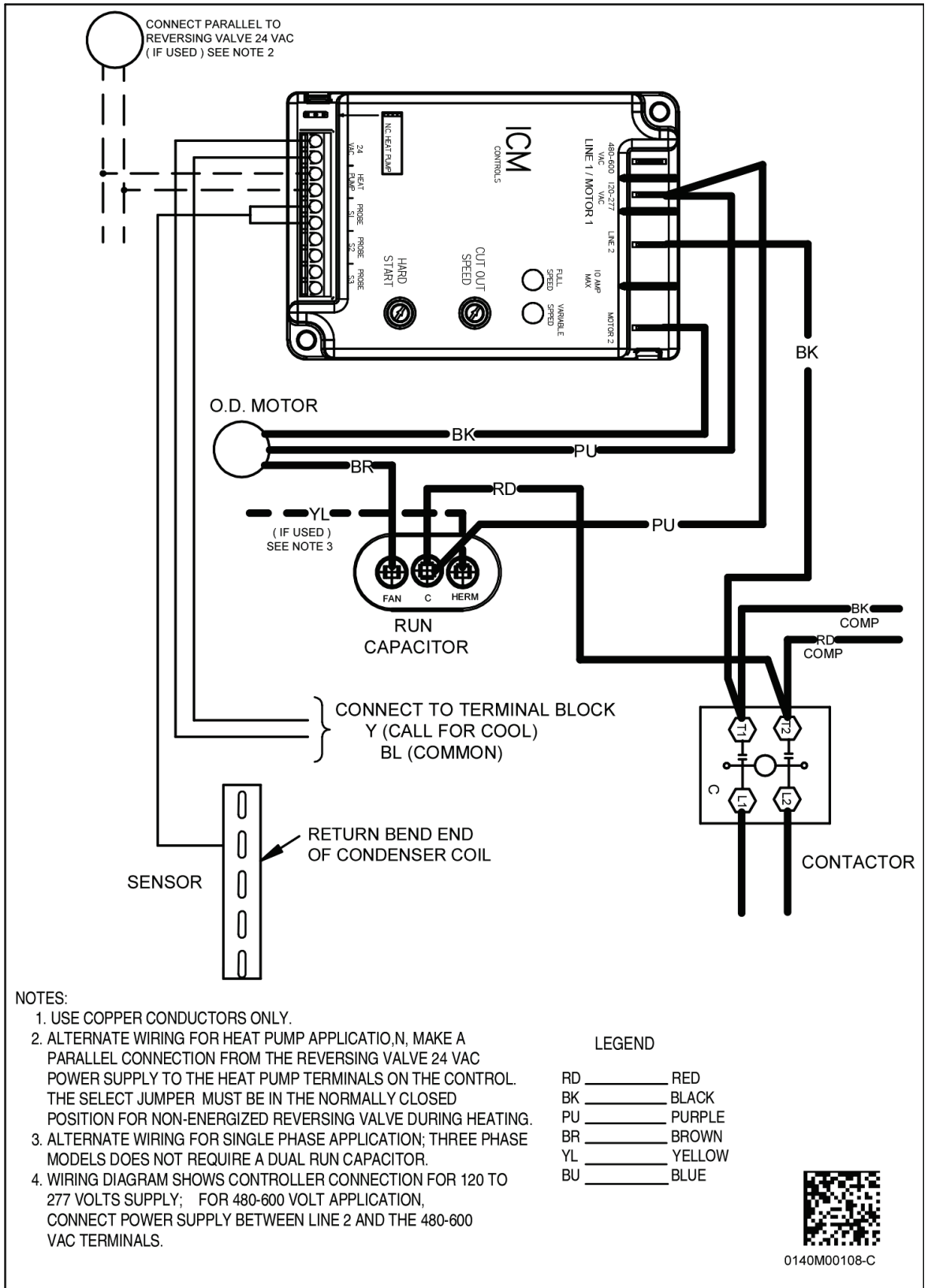

**NOTICE: The cutout speed & hard start settings are factory preset. Changing those settings may cause early motor failure.**

Wiring is subject to change. Always refer to the wiring diagram on the unit for the most up-to-date wiring.

**WARNING**

**HIGH VOLTAGE!**  
 DISCONNECT ALL POWER BEFORE SERVICING OR INSTALLING THIS UNIT. MULTIPLE POWER SOURCES MAY BE PRESENT. FAILURE TO DO SO MAY CAUSE PROPERTY DAMAGE, PERSONAL INJURY OR DEATH.

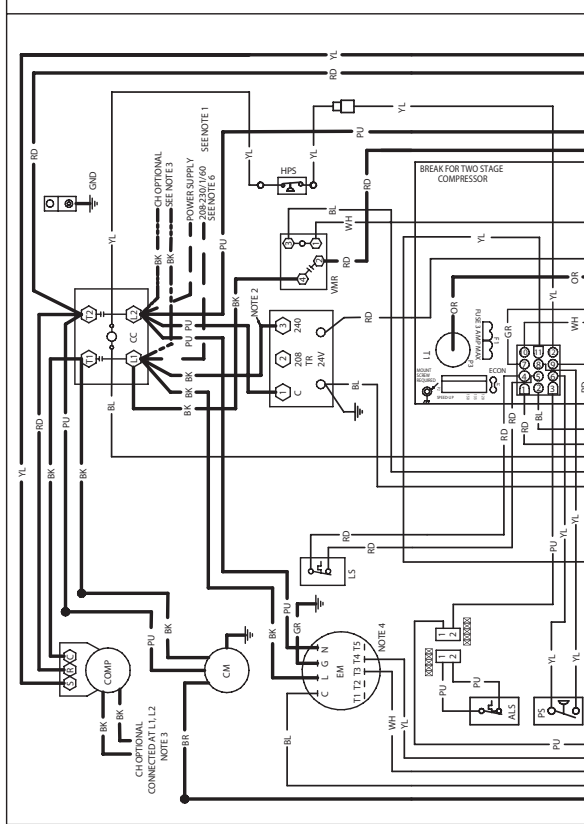
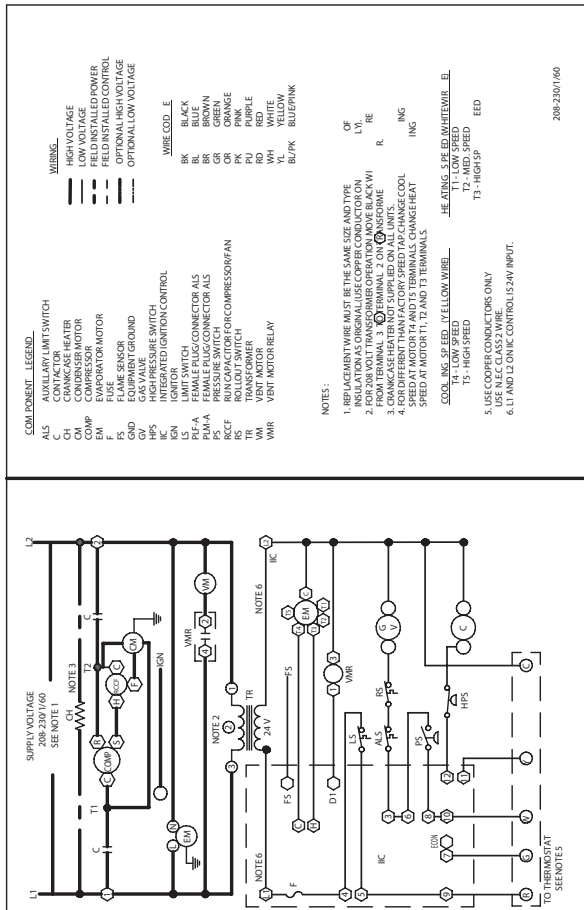

**COMPONENT LEGEND**

ALS: AUXILIARY LIMIT SWITCH  
 CH: CHIMNEY HEATER MOTOR  
 C: COMPRESSOR  
 EM: EVAPORATOR MOTOR  
 FS: FLAME SENSOR  
 GND: EQUIPMENT GROUND  
 HPS: HIGH PRESSURE SWITCH  
 IC: INTEGRATED IGNITION CONTROL  
 LS: LIMIT SWITCH  
 P: FEMALE PLUG CONNECTOR  
 P-A: FEMALE PLUG CONNECTOR ALS  
 P-W: FEMALE PLUG CONNECTOR W  
 RC: RUN CAPACITOR FOR COMPRESSOR/FAN  
 RC-F: RUN CAPACITOR FOR FAN  
 TR: TRANSFORMER  
 VM: VENT MOTOR  
 WMR: VENT MOTOR RELAY

**WIRE COLOR**

HIGH VOLTAGE: BK, BL, BU, GR, OR, PU, RD, YL, BU/PK  
 LOW VOLTAGE: BK, BL, BU, GR, OR, PU, RD, YL, BU/PK  
 FIELD WIALED CONTROL: BK, BL, BU, GR, OR, PU, RD, YL, BU/PK  
 OPTIONAL HIGH VOLTAGE: BK, BL, BU, GR, OR, PU, RD, YL, BU/PK  
 OPTIONAL LOW VOLTAGE: BK, BL, BU, GR, OR, PU, RD, YL, BU/PK

**NOTES:**

- REPLACEMENT WIRE MUST BE THE SAME SIZE AND TYPE OF INSULATION AS ORIGINAL USE COPPER CONDUCTOR ON ALL WIRING.
- INSULATION ON ALL WIRING MUST BE THE SAME TYPE AND COLOR AS ORIGINAL.
- CRIMPER HEATER NOT SUPPLIED ON ALL UNITS. FROM TERMINAL 3 TO TERMINAL 2 ON 208/230V/60Hz SUPPLY.
- DIFFERENT THAN FACTORY WIRING. WIRING CHANGE COOL SPEED AT MOTOR T1, T2 AND T3 TERMINALS.
- USE COOPER CONDUCTORS ONLY.
- LI AND L2 ON IC CONTROL IS 24V INPUT.

**COOLING SPEED YELLOW WIRE**

T1 - LOW SPEED  
 T2 - MID SPEED  
 T3 - HIGH SPEED

**HEATING SPEED WHITE WIRE**

T1 - LOW SPEED  
 T2 - MID SPEED  
 T3 - HIGH SPEED

208-230/160

**INSTALLER/SERVICEMAN**

THE STATUS LIGHT ON THE FURNACE CONTROL MAY BE USED TO TROUBLESHOOT THIS APPLIANCE. STATUS LIGHT CODES ARE AS FOLLOWS:

STATUS LIGHT	EQUIP. STATUS	CHECK
ON	NORMAL OPERATION	
OFF	NO POWER OR INTERNAL CONTROL FAILURE	CHECK INPUT POWER CHECK FUSE ON CONTROL REPLACE CONTROL
1 BLINK	IGNITION FAILURE OPEN ROLLOUT SWITCH OPEN AUX. LIMIT PRESSURE SWITCH OPEN	CHECK GAS VALVE FLAME ROLLOUT BAD SWITCH AUXILIARY LIMIT CHECK PRESSURE SWITCH
2 BLINKS	PRESSURE SWITCH CLOSED TOO LONG	REPLACE PRESSURE SWITCH
3 BLINKS	OPEN LIMIT SWITCH	MANUAL LIMIT OPEN BAD SWITCH
4 BLINKS	FALSE FLAME SENSED	3MIN. COMP. ANTICYCLE TIMER
5 BLINKS	COMPRESSOR OUTPUT DELAY	
6 BLINKS		

**THEMOSTAT FIELD WIRING**

SEE NOTES

NOLECON. OMIZER

W  
GR  
RD  
YL  
BL

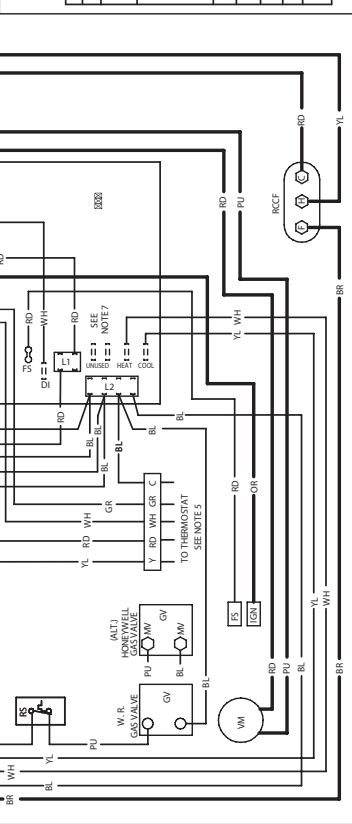

01HG03348-B

QR CODE

Wiring is subject to change. Always refer to the wiring diagram on the unit for the most up-to-date wiring.

**WARNING**

**HIGH VOLTAGE!**  
DISCONNECT ALL POWER BEFORE SERVICING OR INSTALLING THIS UNIT. MULTIPLE POWER SOURCES MAY BE PRESENT. FAILURE TO DO SO MAY CAUSE PROPERTY DAMAGE, PERSONAL INJURY OR DEATH.

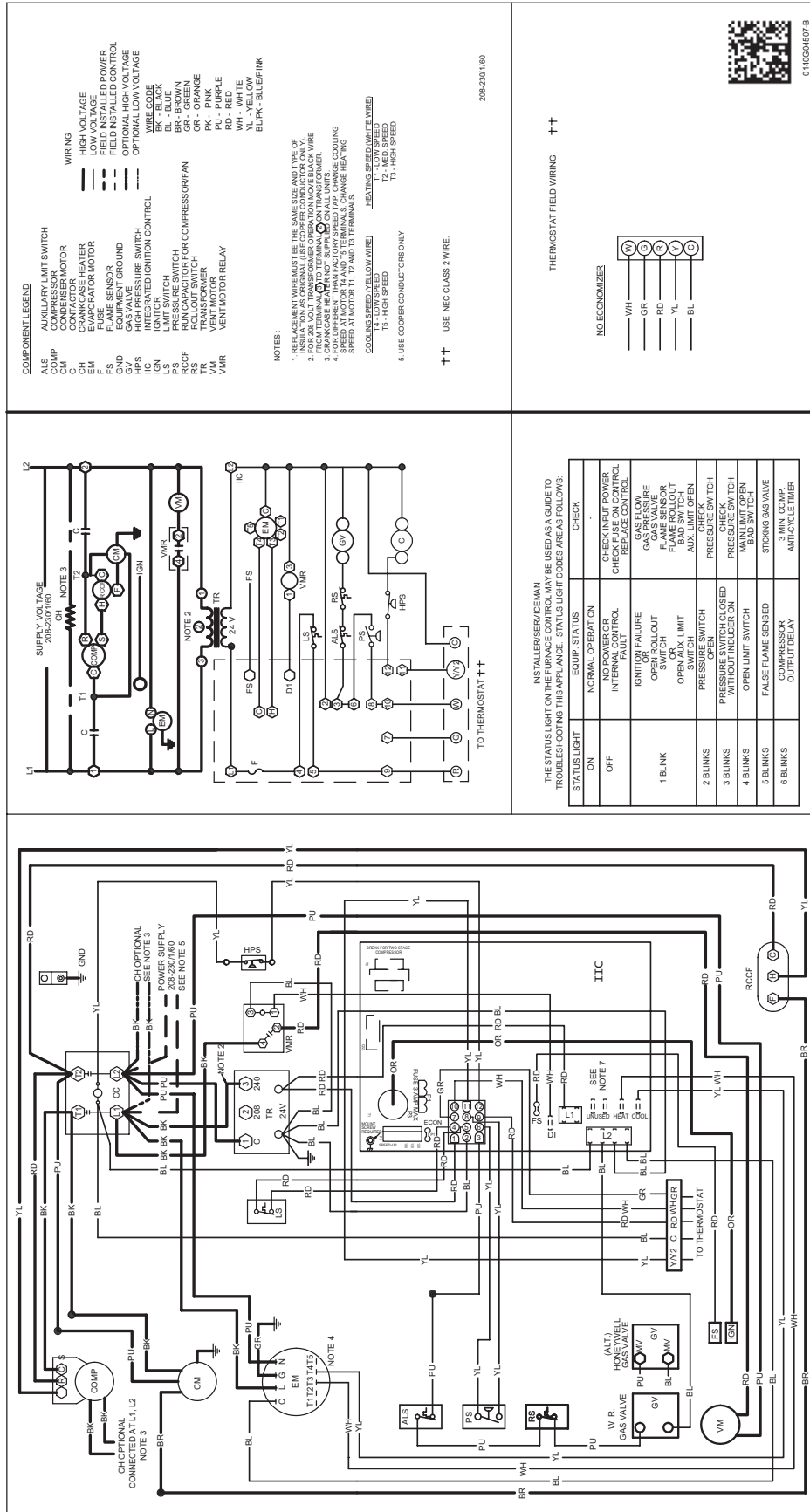

INSTALLER/SERVICEMAN THE STATUS LIGHT ON THE FURNACE CONTROL MAY BE USED AS A GUIDE TO TROUBLESHOOTING THIS APPLIANCE. STATUS LIGHT CODES ARE AS FOLLOWS.

STATUS LIGHT	EQUIP. STATUS	CHECK
ON	NORMAL OPERATION	-
OFF	NO POWER OR INTERNAL CONTROL PAULT	CHECK INLET POWER CHECK FUSE ON CONTROL REPLACE FUSE
1 BLINK	IGNITION FAILURE OPEN ROLLOUT SWITCH OPEN AUX. LIMIT OR PRESSURE SWITCH	CHECK INLET GAS PRESSURE GAS VALVE GAS PRESSURE FLAME ROLLOUT BAD SWITCH AUX. CHECK OPEN
2 BLINKS	PRESSURE SWITCH OPEN	PRESSURE SWITCH
3 BLINKS	PRESSURE SWITCH CLOSED INTERNAL CONTROL PAULT	CHECK PRESSURE SWITCH INTERNAL CONTROL
4 BLINKS	OPEN LIMIT SWITCH	MAIN LIMIT OPEN BAD SWITCH
5 BLINKS	FALSE FLAME SENSED COMPRESSOR OUTPUT DELAY	STUCK GAS VALVE 3 MIN. COMP. ANTI-CYCLE TIMER
6 BLINKS		









**WARNING** HIGH VOLTAGE! DISCONNECT ALL POWER BEFORE SERVICING OR INSTALLING THIS UNIT.

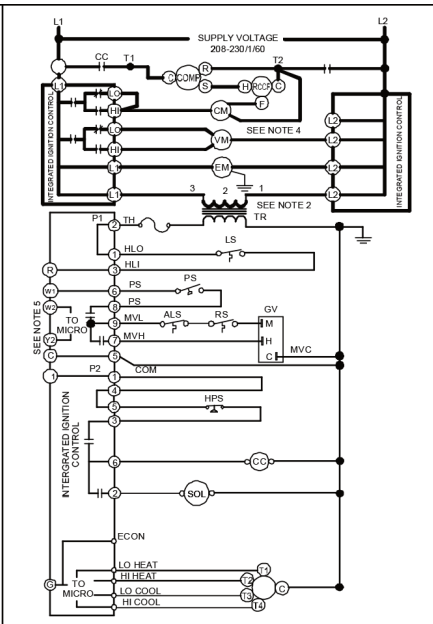
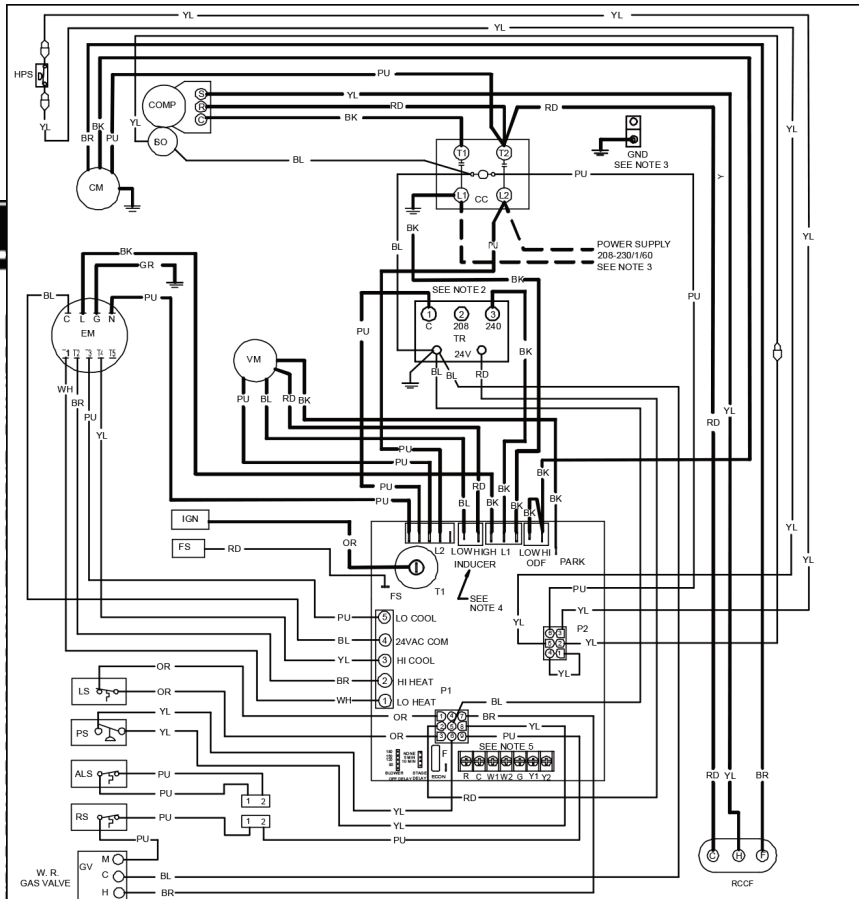

**COMPONENT LEGEND**

ALS	AUXILIARY LIMIT SWITCH
CC	CONTACTOR
CM	CONDENSER MOTOR
COMP	COMPRESSOR
EM	EVAPORATOR MOTOR
F	FUSE
FS	FLAME SENSOR
GND	EQUIPMENT GROUND
GV	GAS VALVE
HLO	HI LIMIT OUTPUT
HLI	HI LIMIT INPUT
HPS	HIGH PRESSURE SWITCH
IGN	IGNITOR
IC	INTEGRATED IGNITION CONTROL
LS	LIMIT SWITCH
MVL	MAIN GAS VALVE LOW
MVH	MAIN GAS VALVE HIGH
MVC	MAIN GAS VALVE COMMON
PS	PRESSURE SWITCH
RS	OUTDOOR FAN
RDCF	RUN CAPACITOR FOR COMPRESSOR/FAN
SOL	SOLENOID (2ND STAGE COOL)
TR	TRANSFORMER
TH	TRANSFORMER HIGH

**NOTES**

1. REPLACEMENT WIRE MUST BE THE SAME SIZE AND TYPE OF INSULATION AS ORIGINAL (USE COPPER CONDUCTOR ONLY).
2. FOR 208 VOLT TRANSFORMER OPERATION MOVE BLACK WIRE FROM TERMINAL 3 TO TERMINAL 2 ON TRANSFORMER.
3. USE COPPER CONDUCTORS ONLY.
4. FOR 208V OPERATION, REMOVE BLUE LEAD FROM INDUCER LOW TERMINAL. MOVE BLACK LEAD FROM PARK TERMINAL ONTO INDUCER LOW TERMINAL. PLACE BLUE LEAD ON PARK TERMINAL.
5. USE NEC CLASS 2 WIRE FOR THERMOSTAT FIELD WIRING.

**FACTORY WIRING**

- LINE VOLTAGE
- LOW VOLTAGE
- OPTIONAL HIGH VOLTAGE

**FIELD WIRING**

- HIGH VOLTAGE
- LOW VOLTAGE

**WIRE CODE**

- BK BLACK
- BL BLUE
- BR BROWN
- GR GREEN
- GY GRAY
- OR ORANGE
- PK PINK
- PU PURPLE
- RD RED
- WH WHITE
- YL YELLOW



DIAGNOSTIC LED	FLASHES	STATUS	CHECK
RED	ON	NORMAL OPERATION	-
	OFF	NO POWER OR INTERNAL CONTROL FAULT	CHECK INPUT POWER (CHECK FUSE(S) REPLACE CONTROL)
	1 FLASH	IGNITION FAILURE	GAS PRESSURE GAS VALVE FLAME SENSOR CHECK AUXILIARY LIMIT SW CHECK ROLLOUT LIMIT SW
	2 FLASHES	PRESSURE SWITCH OPEN	CHECK PRESSURE SWITCH CHECK TUBING
	3 FLASHES	PRESSURE SWITCH CLOSED WITHOUT INDUCER ON	CHECK VENT MOTOR
	4 FLASHES	OPEN LIMIT SWITCH	CHECK MAIN LIMIT SWITCH
	5 FLASHES	FALSE FLAME DETECTED	CHECK GAS VALVE CHECK FOR SHORTS IN FLAME SENSOR WIRING
	6 FLASHES	COMPR. SHORT CYCLE DELAY	3 MIN COMP. SHORT CYCLE DELAY
	7 FLASHES	LIMIT OPEN 5 TIMES IN SAME CALL FOR HEAT	CHECK MAIN LIMIT SWITCH CHECK AUXILIARY LIMIT SW
AMBER	OFF	NO FLAME PRESENT	-
	ON	NORMAL FLAME PRESENT	-
	1 FLASH	LOW FLAME SIGNAL	GAS FLOW GAS PRESSURE GAS VALVE FLAME SENSOR
	2 FLASHES	FALSE FLAME DETECTED	CHECK GAS VALVE CHECK FOR SHORTS IN FLAME SENSOR WIRING

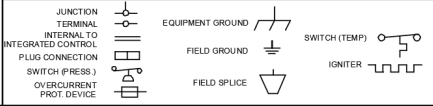

Wiring is subject to change. Always refer to the wiring diagram on the unit for the most up-to-date wiring.