

Service and Troubleshooting

80% SINGLE STAGE GAS FURNACES GM9S80, AM9S80, GC9S80, AC9S80, VM9S80, VC9S80 & ACCESSORIES

Pride and workmanship go into every product to provide our customers with quality products. It is possible, however, that during its lifetime a product may require service. Products should be serviced only by a qualified service technician who is familiar with the safety procedures required in the repair and who is equipped with the proper tools, parts, testing instruments and the appropriate service manual. **REVIEW ALL SERVICE INFORMATION IN THE APPROPRIATE SERVICE MANUAL BEFORE BEGINNING REPAIRS.**



WARNING

ONLY PERSONNEL THAT HAVE BEEN TRAINED TO INSTALL, ADJUST, SERVICE OR REPAIR (HEREINAFTER, "SERVICE") THE EQUIPMENT SPECIFIED IN THIS MANUAL SHOULD SERVICE THE EQUIPMENT. THE MANUFACTURER WILL NOT BE RESPONSIBLE FOR ANY INJURY OR PROPERTY DAMAGE ARISING FROM IMPROPER SERVICE OR SERVICE PROCEDURES. IF YOU SERVICE THIS UNIT, YOU ASSUME RESPONSIBILITY FOR ANY INJURY OR PROPERTY DAMAGE WHICH MAY RESULT. IN ADDITION, IN JURISDICTIONS THAT REQUIRE ONE OR MORE LICENSES TO SERVICE THE EQUIPMENT SPECIFIED IN THIS MANUAL, ONLY LICENSED PERSONNEL SHOULD SERVICE THE EQUIPMENT. IMPROPER INSTALLATION, ADJUSTMENT, SERVICING OR REPAIR OF THE EQUIPMENT SPECIFIED IN THIS MANUAL, OR ATTEMPTING TO INSTALL, ADJUST, SERVICE OR REPAIR THE EQUIPMENT SPECIFIED IN THIS MANUAL WITHOUT PROPER TRAINING MAY RESULT IN PRODUCT DAMAGE, PROPERTY DAMAGE, PERSONAL INJURY OR DEATH.

TABLE OF CONTENTS

IMPORTANT INFORMATION	2
PRODUCT IDENTIFICATION	4
SYSTEM OPERATION	5
SCHEDULED MAINTENANCE	25
SERVICING	29
CHECKING VOLTAGE	30
CHECKING WIRING	30
CHECKING THERMOSTAT, WIRING	30
CHECKING TRANSFORMER AND CONTROL CIRCUIT	31
CHECKING AIR CIRCULATOR BLOWER MOTOR	31
CHECKING DUCT STATIC	32
CHECKING TEMPERATURE RISE	32
CHECKING PRIMARY LIMIT CONTROL	33
CHECKING AUXILIARY LIMIT CONTROL	33
CHECKING FLAME ROLLOUT CONTROL	34
INDUCED DRAFT BLOWER MOTOR	35
CHECKING GAS VALVE (REDUNDANT)	35
CHECKING MAIN BURNERS	35
CHECKING ORIFICES	35
CHECKING GAS PRESSURE	36
CHECKING HOT SURFACE IGNITER	38
CHECKING FOR FLASHBACK	38
CHECKING PRESSURE SWITCH	38
HIGH ALTITUDE APPLICATION	39
CHECKING FOR DELAYED IGNITION	39
CHECKING INTEGRATED IGNITION CONTROL BOARDS	40
CHECKING FLAME SENSOR	40
AIRFLOW TABLES	42
1 STAGE STATUS CODES	50
1 STAGE TROUBLESHOOTING CODES	52
WIRING DIAGRAMS	54

RS6621008
July 2021

IMPORTANT INFORMATION

IMPORTANT NOTICES



RECOGNIZE SAFETY SYMBOLS, WORDS AND LABELS

Pride and workmanship go into every product to provide our customers with quality products. It is possible, however, that during its lifetime a product may require service. Products should be serviced only by a qualified service technician who is familiar with the safety procedures required in the repair and who is equipped with the proper tools, parts, testing instruments and the appropriate service manual. **REVIEW ALL SERVICE INFORMATION IN THE APPROPRIATE SERVICE MANUAL BEFORE BEGINNING REPAIRS.**



WARNING

THIS UNIT SHOULD NOT BE CONNECTED TO, OR USED IN CONJUNCTION WITH, ANY DEVICES THAT ARE NOT DESIGN CERTIFIED FOR USE WITH THIS UNIT OR HAVE NOT BEEN TESTED AND APPROVED BY THE MANUFACTURER. SERIOUS PROPERTY DAMAGE OR PERSONAL INJURY, REDUCED UNIT PERFORMANCE AND/OR HAZARDOUS CONDITIONS MAY RESULT FROM THE USE OF DEVICES THAT HAVE NOT BEEN APPROVED OR CERTIFIED BY THE MANUFACTURER.



WARNING

TO PREVENT THE RISK OF PROPERTY DAMAGE, PERSONAL INJURY OR DEATH, DO NOT STORE COMBUSTIBLE MATERIALS OR USE GASOLINE OR OTHER FLAMMABLE LIQUIDS OR VAPORS IN THE VICINITY OF THIS APPLIANCE.



WARNING

HIGH VOLTAGE
DISCONNECT ALL POWER BEFORE SERVICING OR INSTALLING THIS UNIT. MULTIPLE POWER SOURCES MAY BE PRESENT. FAILURE TO DO SO MAY CAUSE PROPERTY DAMAGE, PERSONAL INJURY OR DEATH.



OUTSIDE THE U.S., call 1-713-861-2500.

(Not a technical assistance line for dealers.) Your telephone company will bill you for the call.

IMPORTANT INFORMATION



WARNING

IF THE INFORMATION IN THESE INSTRUCTIONS IS NOT FOLLOWED EXACTLY, A FIRE OR EXPLOSION MAY RESULT CAUSING PROPERTY DAMAGE, PERSONAL INJURY OR LOSS OF LIFE.

- DO NOT STORE OR USE GASOLINE OR OTHER FLAMMABLE VAPORS AND LIQUIDS IN THE VICINITY OF THIS OR ANY OTHER APPLIANCE.

- WHAT TO DO IF YOU SMELL GAS:

- DO NOT TRY TO LIGHT ANY APPLIANCE.
- DO NOT TOUCH ANY ELECTRICAL SWITCH; DO NOT USE ANY PHONE IN YOUR BUILDING.
- IMMEDIATELY CALL YOUR GAS SUPPLIER FROM A NEIGHBOR'S PHONE. FOLLOW THE GAS SUPPLIER'S INSTRUCTIONS. IF YOU CANNOT REACH YOUR GAS SUPPLIER, CALL THE FIRE DEPARTMENT.

- INSTALLATION AND SERVICE MUST BE PERFORMED BY A QUALIFIED INSTALLER, SERVICE AGENCY OR THE GAS SUPPLIER.



WARNING

SHOULD OVERHEATING OCCUR OR THE GAS SUPPLY FAIL TO SHUT OFF, TURN OFF THE MANUAL GAS SHUTOFF VALVE EXTERNAL TO THE FURNACE BEFORE TURNING OFF THE ELECTRICAL SUPPLY.



DANGER
PELIGRO



CARBON MONOXIDE POISONING HAZARD

Special Warning for Installation of Furnace or Air Handling Units in Enclosed Areas such as Garages, Utility Rooms or Parking Areas

Carbon monoxide producing devices (such as an automobile, space heater, gas water heater, etc.) should not be operated in enclosed areas such as unventilated garages, utility rooms or parking areas because of the danger of carbon monoxide (CO) poisoning resulting from the exhaust emissions. If a furnace or air handler is installed in an enclosed area such as a garage, utility room or parking area and a carbon monoxide producing device is operated therein, there must be adequate, direct outside ventilation.

This ventilation is necessary to avoid the danger of CO poisoning which can occur if a carbon monoxide producing device continues to operate in the enclosed area. Carbon monoxide emissions can be (re)circulated throughout the structure if the furnace or air handler is operating in any mode.

CO can cause serious illness including permanent brain damage or death.

B10259-216

RIESGO DE INTOXICACIÓN POR MONÓXIDO DE CARBONO

Advertencia especial para la instalación de calentadores ó manejadoras de aire en áreas cerradas como estacionamientos ó cuartos de servicio.

Los equipos ó aparatos que producen monóxido de carbono (tal como automóvil, calentador de gas, calentador de agua por medio de gas, etc) no deben ser operados en áreas cerradas debido al riesgo de envenenamiento por monóxido de carbono (CO) que resulta de las emisiones de gases de combustión. Si el equipo ó aparato se opera en dichas áreas, debe existir una adecuada ventilación directa al exterior.

Esta ventilación es necesaria para evitar el peligro de envenenamiento por CO, que puede ocurrir si un dispositivo que produce monóxido de carbono sigue operando en el lugar cerrado.

Las emisiones de monóxido de carbono pueden circular a través del aparato cuando se opera en cualquier modo.

El monóxido de carbono puede causar enfermedades severas como daño cerebral permanente ó muerte.

B10259-216

RISQUE D'EMPOISONNEMENT AU MONOXYDE DE CARBONE

Avertissement special au sujet de l'installation d'appareils de chauffage ou de traitement d'air dans des endroits clos, tels les garages, les locaux d'entretien et les stationnements.

Evitez de mettre en marche les appareils produisant du monoxyde de carbone (tels que les automobile, les appareils de chauffage autonome, etc.) dans des endroits non ventilés tels que les d'empoisonnement au monoxyde de carbone. Si vous devez faire fonctionner ces appareils dans un endroit clos, assurez-vous qu'il y ait une ventilation directe provenant de l'exterieur.

Cette ventilation est nécessaire pour éviter le danger d'intoxication au CO pouvant survenir si un appareil produisant du monoxyde de carbone continue de fonctionner au sein de la zone confinée.

Les émissions de monoxyde de carbone peuvent être recirculés dans les endroits clos, si l'appareil de chauffage ou de traitement d'air sont en marche.

Le monoxyde de carbone peut causer des maladies graves telles que des dommages permanents au cerveau et même la mort.

B10259-216

PRODUCT IDENTIFICATION

NOMENCLATURE

The model and manufacturing number are used for positive identification of component parts used in manufacturing. Please use these numbers when requesting service or parts information.

	A	M	9	C	8	0	0	6	0	3	B	N	A	A
	1	2	3	4	5	6	7	8	9	10	11	12	13	14
Brand											Minor Revision			
G - Goodman® Brand											A - Initial Release			
V - GMC® Brand											B - 1st Revision			
A - AMANA® Brand														
Configuration											Major Revision			
M - Upflow/Horizontal											A - Initial Release			
C - Downflow/Horizontal											B - 1st Revision			
											Nox			
Motor											N = > 40 NG/J NOx			
9 - Nine Speed ECM											X = < 40 NG/J NOx			
											U = < 14NG/J NOx			
											Cabinet Width			
Gas Valve											A - 14"			
C - 2 Stage											B - 17.5"			
S - 1 STAGE											C - 21"			
											D - 24.5"			
											Maximum CFM			
AFUE											3 - 1200 CFM			
80 - 80% AFUE 92 - 92% AFUE											4 - 1600 CFM			
96 - 96% AFUE 97 - 97% AFUE											5 - 2000 CFM			
MBTU/h														
030 - 30,000 BTU/h 080 - 80,000 BTU/h														
040 - 40,000 BTU/h 100 - 100,000 BTU/h														
060 - 60,000 BTU/h 120 - 120,000 BTU/h														

SYSTEM OPERATION

NORMAL SEQUENCE OF OPERATION

POWER UP

1. 115 VAC power applied to furnace.
2. Integrated ignition control module performs internal checks.
3. Integrated ignition control module LED will light.
4. Integrated ignition control monitors safety circuits continuously.
5. Furnace awaits call from thermostat.

NORMAL HEATING SEQUENCE

1. R and W thermostat contacts close, initiating a call for heat.
2. Integrated control module performs safety circuit checks.
3. The induced draft blower is energized causing pressure switch contacts to close. Induced draft blower remains energized for pre-purge period.
4. Ignitor warm up begins after pre-purge is completed.
5. Gas valve opens at end of ignitor warm up period, delivering gas to burners to establish flame.
6. The control checks for a signal from the flame sensor within seven (4) seconds after the gas valve is energized. Gas will only continue to flow if a flame signal is present.
7. Circulator blower is energized on heat speed following a fixed thirty (30) second blower on delay.
8. Furnace runs, integrated control module monitors safety circuits continuously.
9. R and W thermostat contacts open, allowing the gas valve to cycle off.
10. Induced draft blower is de-energized following a fifteen (15) - second post purge.
11. Circulator blower is de-energized following a selectable heat off delay period (90, 120, 150 or 180 seconds).
12. Furnace awaits next call from thermostat.

The adjustable delay-off timing allows the installer to customize the comfort level.

COOLING MODE

The normal operational sequence in cooling mode is as follows:

1. R and Y thermostat contacts close, initiating a call for cool.
2. Integrated control module performs safety circuit checks.
3. Outdoor fan and compressor are energized.
4. Circulator blower is energized on cool speed following a fixed five (7) second on delay.
5. Furnace circulator blower and outdoor cooling unit run, integrated control module monitors safety circuits continuously.
6. R and Y thermostat contacts open, completing the call for cool.
7. Outdoor fan and compressor are de-energized.





8. Circulator blower is de-energized following a fixed forty five (65) second cool off delay period.
9. Furnace awaits next call from thermostat.

FAN ONLY MODE

The normal operational sequence in fan only mode is as follows:

1. R and G thermostat contacts close, initiating a call for fan.
2. Integrated control module performs safety circuit checks.
3. Circulator blower is energized on **heat speed**.
4. Circulator blower runs, integrated control module monitors safety circuits continuously.
5. R and G thermostat contacts open, completing the call for fan.
6. Circulator blower is de-energized.
7. Furnace awaits next call from thermostat.

ELECTRICAL CONNECTIONS

 WARNING
TO AVOID THE RISK OF ELECTRICAL SHOCK, WIRING TO THE UNIT MUST BE PROPERLY POLARIZED AND GROUNDED.
 WARNING
HIGH VOLTAGE DISCONNECT ALL POWER BEFORE SERVICING OR INSTALLING THIS UNIT. MULTIPLE POWER SOURCES MAY BE PRESENT. FAILURE TO DO SO MAY CAUSE PROPERTY DAMAGE, PERSONAL INJURY OR DEATH.

 CAUTION
LABEL ALL WIRES PRIOR TO DISCONNECTION WHEN SERVICING CONTROLS. WIRING ERRORS CAN CAUSE IMPROPER AND DANGEROUS OPERATION. VERIFY PROPER OPERATION AFTER SERVICING.

WIRING HARNESS

The wiring harness is an integral part of this furnace. Field alteration to comply with electrical codes should not be required. Wires are color coded for identification purposes. Refer to the wiring diagram for wire routings. If any of the original wire as supplied with the furnace must be replaced, it must be replaced with wiring material having a temperature rating of at least 105° C. Any replacement wiring must be copper conductor.

115 VOLT LINE CONNECTIONS

Before proceeding with electrical connections, ensure that the supply voltage, frequency, and phase correspond to that specified on the unit rating plate. Power supply to the furnace must be N.E.C. Class 1, and must comply with all

SYSTEM OPERATION

applicable codes. The furnace must be electrically grounded in accordance with local codes or, in their absence, with the latest edition of The National Electric Code, ANSI NFPA 70 and/or The Canadian Electric Code CSA C22.1. An electrical disconnect must be provided at the furnace location.

NOTE: Line polarity must be observed when making field connections.

Connect hot, neutral, and ground wires as shown in the wiring diagram located on the unit's blower door. Metal conduit is not considered a substitute for an actual ground wire to the unit. Line polarity must be observed when making field connections. Line voltage connections can be made through either the right or left side panel.

The furnace is shipped configured for a right side (left side for counterflow) electrical connection with the junction box located inside the burner compartment. To make electrical connections through the opposite side of the furnace, the junction box must be relocated to the other side of the burner compartment prior to making electrical connections.

CAUTION

EDGES OF SHEET METAL HOLES MAY BE SHARP. USE GLOVES AS A PRECAUTION WHEN REMOVING HOLE PLUGS.

NOTE: Wire routing must not interfere with circulator blower operation, filter removal, or routine maintenance.



WARNING

TO AVOID THE RISK OF ELECTRICAL SHOCK, INJURY, OR DEATH, THE FURNACE MUST BE ELECTRICALLY GROUNDED IN ACCORDANCE WITH LOCAL CODES OR, IN THEIR ABSENCE, WITH THE LATEST EDITION OF THE NATIONAL ELECTRIC CODE.

115 VOLT LINE CONNECTION OF ACCESSORIES (ELECTRONIC AIR CLEANER)

WARNING

HIGH VOLTAGE
DISCONNECT ALL POWER BEFORE SERVICING OR CHANGING ANY ELECTRICAL WIRING. MULTIPLE POWER SOURCES MAY BE PRESENT. FAILURE TO DO SO MAY CAUSE PROPERTY DAMAGE, PERSONAL INJURY OR DEATH.



ACCESSORY LOAD SPECIFICATIONS	
Electronic Air Cleaner	1.0 Amp maximum at 120 VAC
Humidifier	1.0 Amp maximum at 24 VAC

Turn OFF power to the furnace before installing any accessories. Follow the humidifier or air cleaner manufacturers' instructions for locating, mounting, grounding, and controlling these accessories.

If it is necessary for the installer to supply additional line voltage wiring to the inside of the furnace, the wiring must conform to all local codes, and have a minimum temperature rating of 105°C. All line voltage wire splices must be made inside the furnace junction box.

ELECTRICAL

24 VOLT THERMOSTAT WIRING

Important Note: Wiring routing must not interfere with circulator blower operation, filter removal or routine maintenance. Low voltage connections can be made through either the right or left side panel. Thermostat wiring entrance holes are located in the blower compartment. The following figure shows connections for a "heat/cool system".

This furnace is equipped with a 40 VA transformer to facilitate use with most cooling equipment. Consult the wiring diagram, located on the blower compartment door, for further details of 115 Volt and 24 Volt wiring.

Thermostat Wiring Diagrams

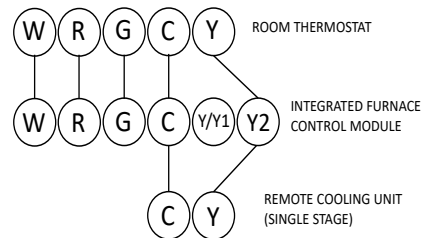

Thermostat - Single-Stage Heating with Single-Stage Cooling

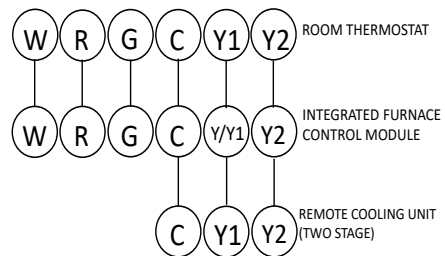

Thermostat - Single-Stage Heating with Two-Stage Cooling

FOSSIL FUEL APPLICATIONS

This furnace can be used in conjunction with a heat pump in a fossil fuel application. A fossil fuel application refers to a combined gas furnace and heat pump installation which uses an outdoor temperature sensor to determine the most cost efficient means of heating (heat pump or gas furnace).

A heat pump thermostat is required to properly use a single-stage furnace in conjunction with a heat pump. Refer to the fossil fuel kit installation instructions for additional thermostat requirements.

Strictly follow the wiring guidelines in the fossil fuel kit installation instructions. All furnace connections must be made to the furnace two-stage integrated control module and the "FURNACE" terminal strip on the fossil fuel control board.

SYSTEM OPERATION

TWINNING

Two furnaces of the same model may be twinned. The integrated control board has a 3/16" terminal labeled "TWIN" located beside the low voltage thermostat connection strip. Twinning allows simultaneous operation of two furnaces and forces the indoor blower motors of each furnace to operate synchronously into a common duct system. Using the twinning function will require only field installed wiring with no external kits or parts. The staging and speed tap options must be set the same on both furnaces.

NOTE: Each furnace must be connected to it's own 115 VAC power supply. The L1 connection to each furnace must be in phase (connected to circuit breakers on the same 115 VAC service panel phase leg). To verify that the furnaces are in phase, check from L1 to L1 on each furnace with a voltmeter. If the furnaces are in phase, the voltage between both furnaces will be ZERO.

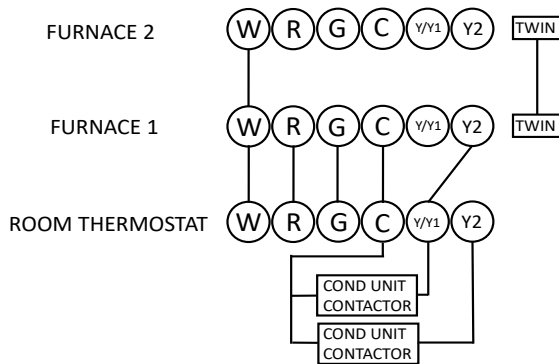

115 VOLT LINE CONNECTION OF ACCESSORIES (HUMIDIFIER AND ELECTRONIC AIR CLEANER)

The furnace integrated control module is equipped with line voltage accessory terminals for controlling power to an optional field-supplied humidifier and/or electronic air cleaner.

The accessory load specifications are noted in the chart:

Humidifier	1.0 Amp maximum at 120 VAC
Electronic Air Cleaner	1.0 Amp maximum at 120 VAC

Turn OFF power to the furnace before installing any accessories. Follow the humidifier or air cleaner manufacturers' instructions for locating, mounting, grounding, and controlling these accessories. Accessory wiring connections are to be made through the 1/4" quick connect terminals provided on the furnace integrated control module. The humidifier and electronic air cleaner hot terminals are identified as HUM H and EAC H. The humidifier and electronic air cleaner neutral terminals are identified as NEUTRAL. All field wiring must conform to applicable codes. Connections should be made as shown.

If it is necessary for the installer to supply additional line voltage wiring to the inside of the furnace, the wiring must conform to all local codes, and have a minimum temperature rating of 105°C. All line voltage wire splices must be made inside the furnace junction box.

The integrated control module humidifier terminal (HUM H) is energized with 115 volts whenever the induced draft blower is energized. The integrated control module electronic air cleaner terminal (EAC H) is energized with 115 volts whenever the circulator blower is energized. This terminal can also be used to provide 115 volt power to a humidifier transformer. The remaining primary transformer wire would be connected to the Line N on the control board.



WARNING

HIGH VOLTAGE!
TO AVOID PERSONAL INJURY OR DEATH DUE TO ELECTRICAL SHOCK, DISCONNECT ELECTRICAL POWER BEFORE SERVICING OR CHANGING ANY ELECTRICAL WIRING.



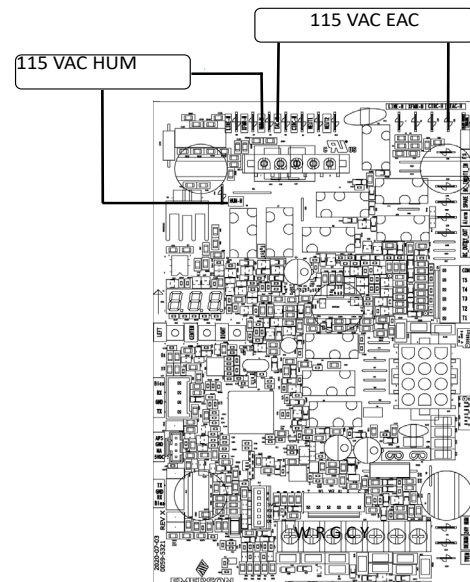

Accessories - Accessories Wiring

LOW VOLTAGE HUMIDIFIER

The furnace integrated control module is equipped with a low voltage terminal for providing power to an optional field-supplied 24 volt humidifier. The 24V HUM terminal is energized any time the draft inducer is powered. See connection diagram below.

NOTE: This is a 24 volt circuit only, the common connection must be on C terminal of the low voltage terminal strip (where thermostat wires are connected). Wiring for this circuit must NOT be connected to the line N location where line voltage neutral wires are connected.

SYSTEM OPERATION

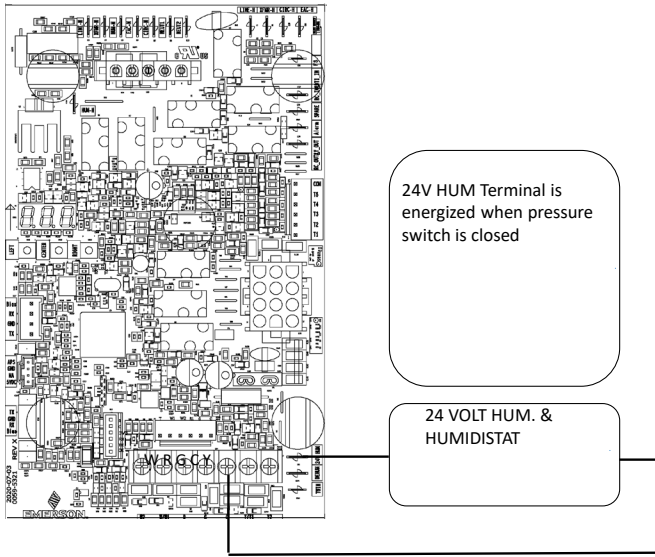

24 Volt Humidifier Connection

FURNACE STARTUP

1. Close the manual gas shutoff valve external to the furnace.
2. Turn off the electrical power to the furnace.
3. Set the room thermostat to the lowest possible setting.
4. Remove the burner compartment door.

NOTE: This furnace is equipped with an ignition device which automatically lights the burner. Do not try to light the burner by hand.

5. Move the furnace gas valve manual control to the OFF position.
6. Wait five minutes then smell for gas. Be sure check near the floor as some types of gas are heavier than air.
7. If you smell gas after five minutes, immediately follow the safety instructions in the *Safety Considerations* on page 2 of this manual. If you do not smell gas after five minutes, move the furnace gas valve manual control to the ON position.
8. Replace the burner compartment door.
9. Open the manual gas shutoff valve external to the furnace.
10. Turn on the electrical power to the furnace.
11. Adjust the thermostat to a setting above room temperature.
12. After the burners are lit, set the thermostat to desired temperature.

GAS HEAT SEQUENCE OF OPERATION

Call for Heat

- On a call for heat, the thermostat contacts close & the control board receives 24 VAC on the W terminal.
- The control board microcomputer runs its self-check routine.
- The control verifies the limit switch is closed (24 VAC on Pin 8 of the 12 Pin connector).

- The control verifies that pressure switch circuit is open (0 VAC on Pin 5).
- The control module performs a gas valve circuitry check to verify gas valve relay state and presence of voltage at the valve.
- The system will energize the Induced draft blower.
- The pre-purge period begins once the pressure switch is detected closed (24 VAC on Pin 5).
- After the completion of pre-purge, the control will energize the igniter.
- After completion of the ignitor warm-up period:
- The gas valve is energized.
- The ignitor is de-energized as soon as flame is sensed.
- After 30 seconds the indoor blower is energized on heating speed.
- When the thermostat is satisfied:
- The gas valve is de-energized.
- The inducer remains energized for the post purge period (15 seconds).
- The indoor blower runs for the selected off delay period (90 seconds by default, adjustable from 30 – 180 seconds).

HEATING MODE SPEED SELECTION

To change the main blower speed in HEATING mode, follow the following steps:

1. Press left or right button till LED displays “gA1 “(for single stage HEATING). Press center button and LED will display the selected speed number as Fxx (xx: Blower speed number).
2. The control shall rotate available speed number every time Left/Right switches are pressed. Table below shows the available speeds for Low & High heat mode.
3. When the center switch is pressed, the current displayed speed shall be selected, and control shall apply the newly selected speed in next heating call.

NOTE: Always refer to the Heating Chart to choose from available heating speeds

THERMOSTAT CALL	AVAILABLE SPEEDS
W/W1	F01
	F02 (DEFAULT)
	F03
	F04

Heating Speed Table for 1 Stage IFC

CONTINUOUS FAN MODE SPEED SELECTION

To change the main blower speed in circulation mode, follow the following steps:

1. Press the left or right switch until LED displays “FSd”. Press the center switch and LED will display the selected speed number as Fxx (xx: Blower speed number from 1 to 9). F01 is the default speed for circulation.
2. The control will rotate available speed number every time left/right switches are pressed. All 9 speeds are available for circulation.

SYSTEM OPERATION

- When the center switch is pressed, the current displayed speed will be selected, and control will immediately apply that speed setting.

THERMOSTAT CALL	AVAILABLE SPEEDS
G	F01 (DEFAULT)
	F02
	F03
	F04
	F05
	F06
	F07
	F08
	F09

Circulation Speed Table

COOLING MODE SEQUENCE OF OPERATION

Low Stage Cooling Mode Sequence:

On a call for low stage cooling, the Y/Y1 or Y/Y1 and G thermostat contacts close signaling the furnace control board with 24 VAC on Y/Y1 or Y/Y1 and G terminals.

- The 7-Segment will display the cool mode: 1 R [
- The compressor and condenser fan are energized.
- The circulator fan is energized at low cool speed after a cool on delay. The electronic air cleaner will also be energized.
- After the thermostat is satisfied, the compressor is de-energized and the Cool Mode Fan Off Delay period begins.
- Following the Cool Mode Fan Off Delay period, the cool circulator and air cleaner relay are de-energized.

2nd Stage Cooling Mode Sequence:

On a call for 2nd stage cooling, the Y2 or Y2 and G thermostat contacts close signaling the furnace control board with 24 VAC on Y2 or Y2 and G terminals.

- The 7-Segment will display the cool mode: 2 R [
- The compressor and condenser fan are energized.
- The circulator fan is energized at cool speed after a cool on delay. The electronic air cleaner will also be energized.
- After the thermostat is satisfied, the compressor is de-energized and the Cool Mode Fan Off Delay period begins.
- Following the Cool Mode Fan Off Delay period, the cool circulator and air cleaner relay are de-energized.

COOLING MODE SPEED SELECTION

To change the main blower speed in COOLING mode, follow the following steps:

- Press the left or right switch until LED displays "AC1" (for single stage COOLING) or "AC2" (for two-stage COOLING). Press the center switch and LED will display the selected speed number as Fxx (xx: Blower speed number from 1 to 9).
- The control will rotate available speed number every time left/right switches are pressed. All 9 speeds are available for both Single and Two Stage cooling.
- When the center switch is pressed, the current displayed speed will be selected, and control will apply the newly selected speed in next cooling call.

THERMOSTAT CALL	AVAILABLE SPEEDS
Y/Y1	F01
	F02
	F03
	F04 (DEFAULT)
	F05
	F06
	F07
	F08
	F09

Single-Stage Cooling Speed Table for 2 Stage IFC

THERMOSTAT CALL	AVAILABLE SPEEDS
Y2	F01
	F02
	F03
	F04
	F05 (DEFAULT)
	F06
	F07
	F08
	F09

Two-Stage Cooling Speed Table for 2 Stage IFC

FURNACE SHUTDOWN

- Set the thermostat to the lowest setting. The integrated control will close the gas valve and extinguish flame. Following a 15 second delay, the induced draft blower will be de-energized. After the blower off delay time expires, the blower de-energizes.
- Remove the burner compartment door and move the furnace gas valve manual control to the OFF position.
- Close the manual gas shutoff valve external to the furnace.
- Replace the burner compartment door.

SYSTEM OPERATION

SAFETY

Please adhere to the following warnings and cautions when installing, adjusting, altering, servicing, or operating the furnace.

 WARNING
TO PREVENT PERSONAL INJURY OR DEATH DUE TO IMPROPER INSTALLATION, ADJUSTMENT, ALTERATION, SERVICE, OR MAINTENANCE, REFER TO THIS MANUAL. FOR ADDITIONAL ASSISTANCE OR INFORMATION, CONSULT A QUALIFIED INSTALLER, SERVICER, AGENCY OR THE GAS SUPPLIER.

 WARNING
THIS PRODUCT CONTAINS OR PRODUCES A CHEMICAL OR CHEMICALS WHICH MAY CAUSE SERIOUS ILLNESS OR DEATH AND WHICH ARE KNOWN TO THE STATE OF CALIFORNIA TO CAUSE CANCER, BIRTH DEFECTS OR OTHER REPRODUCTIVE HARM.

 WARNING
TO PREVENT PERSONAL INJURY OR DEATH DUE TO IMPROPER INSTALLATION, ADJUSTMENT, ALTERATION, SERVICE, OR MAINTENANCE, REFER TO THIS MANUAL. FOR ADDITIONAL ASSISTANCE OR INFORMATION, CONSULT A QUALIFIED INSTALLER, SERVICER, AGENCY OR THE GAS SUPPLIER.

 WARNING
TO PREVENT POSSIBLE PROPERTY DAMAGE, PERSONAL INJURY OR DEATH DUE TO ELECTRICAL SHOCK, THE FURNACE MUST BE LOCATED TO PROTECT THE ELECTRICAL COMPONENTS FROM WATER.

CHARGE (ESD) PRECAUTIONS

NOTE: Discharge body's static electricity before touching unit. An electrostatic discharge can adversely affect electrical components.

Use the following precautions during furnace installation and servicing to protect the integrated control module from damage. By putting the furnace, the control, and the person at the same electrostatic potential, these steps will help avoid exposing the integrated control module to electrostatic discharge. This procedure is applicable to both installed and uninstalled (ungrounded) furnaces.

1. Disconnect all power to the furnace. Do not touch the integrated control module or any wire connected to the control prior to discharging your body's electrostatic charge to ground.
2. Firmly touch a clean, unpainted, metal surface of the furnace near the control. Any tools held in a person's hand during grounding will be discharged.
3. Service integrated control module or connecting wiring following the discharge process in Step 2. Use caution not to recharge your body with static electricity; (i.e., do not move or shuffle your feet, do not touch ungrounded objects, etc.). If you come in contact with an ungrounded object, repeat Step 2 before touching control or wires.

4. Discharge any static electricity from your body to ground before removing a new control from its container. Follow Steps 1 through 3 if installing the control on a furnace. Return any old or new controls to their containers before touching any ungrounded object.

PRODUCT APPLICATION

This product is designed for use as a residential home gas furnace. It is **not** designed or certified for use in mobile home, trailer, or recreational vehicle applications.

This furnace can be used in the following non-industrial commercial applications: **Schools, Office buildings, Churches, Retail stores, Nursing homes, Hotels/motels, Common or office areas.** In such applications, the furnace must be installed with the installation instructions.

Goodman & Amana® 80% furnaces are ETL certified appliances and are appropriate for use with natural or propane gas. (**NOTE:** If using propane gas, a propane conversion kit is required).

IMPORTANT NOTE: The 80% furnace cannot be installed as a direct vent (i.e., sealed combustion) furnace. The burner box is present only to help reduce sound transmission from the burners to the occupied space.

To ensure proper installation, operation and servicing, thoroughly read the installation and service manuals for specifics pertaining to the installation, servicing and application of this product.

 WARNING
POSSIBLE PROPERTY DAMAGE, PERSONAL INJURY OR DEATH DUE TO FIRE, EXPLOSION, SMOKE, SOOT, CONDENSATION, ELECTRICAL SHOCK OR CARBON MONOXIDE MAY RESULT FROM IMPROPER INSTALLATION, REPAIR, OPERATION OR MAINTENANCE OF THIS PRODUCT.

 WARNING
TO PREVENT PROPERTY DAMAGE, PERSONAL INJURY OR DEATH DUE TO FIRE, DO NOT INSTALL THIS FURNACE IN A MOBILE HOME, TRAILER, OR RECREATIONAL VEHICLE.

To ensure proper furnace operation, install, operate, maintain and service the furnace in accordance with the installation, operation and service instructions, all local building codes and ordinances. In their absence, follow the latest edition of the National Fuel Gas Code (NFPA 54/ANSI Z223.1), and/or CAN/CGA B149 Installation Codes, local plumbing or waste water codes, and other applicable codes.

The rated heating capacity of the furnace should be greater than or equal to the total heat loss of the area to be heated. The total heat loss should be calculated by an approved method or in accordance with "ASHRAE Guide" or "Manual J-Load Calculations" published by the Air Conditioning Contractors of America.

SYSTEM OPERATION

LOCATION REQUIREMENTS AND CONSIDERATIONS



WARNING

TO PREVENT POSSIBLE EQUIPMENT DAMAGE, PERSONAL INJURY OR DEATH, THE FOLLOWING BULLET POINTS MUST BE OBSERVED WHEN INSTALLING THE UNIT.

Follow the instructions listed below when selecting a furnace location. Refer also to the guidelines provided in the *Combustion and Ventilation Air Requirements* section in this manual or the installation instructions for details.

- Centrally locate the furnace with respect to the proposed or existing air distribution system.
- Ensure the temperature of the return air entering the furnace is between 55°F and 100°F when the furnace is heating.
- If the furnace is installed in an application where the typical operating sound level of a furnace is deemed objectionable, an optional sound reduction kit is available. Consult your local distributor for more details.
- Provide provisions for venting combustion products outdoors through a proper venting system. Special consideration should be given to vent/flue pipe routing and combustion air intake pipe when applicable.
- **80% Furnaces:** All installations must be vented in accordance with National Fuel Gas Code, NFPA 54/ANSI Z223.1 - latest edition. In Canada the furnaces must be vented in accordance with the National Standard of Canada, CAN/CGA B149.
- Ensure upflow or horizontal furnaces are not installed directly on carpeting, or any other combustible material. The only combustible material allowed is wood.
- A special accessory subbase must be used for upright counterflow unit installations over any combustible material (including wood). Refer to subbase instructions for installation details. (**NOTE:** A subbase will not be required if an air conditioning coil is located beneath the furnace between the supply air opening and the combustible floor.)
- Exposure to contaminated combustion air will result in safety and performance-related problems. Do not install the furnace where the combustion air is exposed to the following substances:
 - chlorinated waxes or cleaners
 - chlorine-based swimming pool chemicals
 - water softening chemicals
 - deicing salts or chemicals
 - carbon tetrachloride
 - halogen type refrigerants
 - cleaning solutions (such as perchloroethylene)
 - printing inks
 - paint removers
 - varnishes
 - hydrochloric acid
 - cements and glues
 - antistatic fabric softeners for clothes dryers
 - and masonry acid washing materials

- Seal off a *non-direct vent* furnace if it is installed near an area frequently contaminated by any of the above substances. This protects the *non-direct vent* furnace from airborne contaminants. To ensure that the enclosed *non-direct vent* furnace has an adequate supply of combustion air, vent from a nearby uncontaminated room or from outdoors. Refer to the *Combustion and Ventilation Air Requirements* section in this manual or the installation instructions for details.
- If the furnace is used in connection with a cooling unit, install the furnace upstream or in parallel with the cooling unit coil. Premature heat exchanger failure will result if the cooling unit coil is placed ahead of the furnace.
- If the furnace is installed in a residential garage, position the furnace so that the burners and ignition source are located not less than 18 inches (457 mm) above the floor. Protect the furnace from physical damage by vehicles.
- If the furnace is installed horizontally, the furnace access doors must be vertical so that the burners fire horizontally into the heat exchanger. Do not install the unit with the access doors on the “up/top” or “down/bottom” side of the furnace.

CLEARANCES AND ACCESSIBILITY

Installations must adhere to the clearances to combustible materials to which this furnace has been design certified. The minimum clearance information for this furnace is provided on the unit's clearance label. These clearances must be permanently maintained. Refer to Specification Sheet for minimum clearances to combustible materials. Clearances must also accommodate an installation's gas, electrical, and drain trap and drain line connections. **NOTE:** In addition to the required clearances to combustible materials, a minimum of 24 inches service clearance must be available in front of the unit.

A furnace installed in a confined space (i.e., a closet or utility room) must have two ventilation openings with a total minimum free area of 0.25 square inches per 1,000 BTU/hr of furnace input rating. One of the ventilation openings must be within 12 inches of the top; the other opening must be within 12 inches of the bottom of the confined space. In a typical construction, the clearance between the door and door frame is usually adequate to satisfy this ventilation requirement.

FURNACE SUSPENSION

If suspending the furnace from rafters or joist, use 3/8" threaded rod and 2"x2"x1/8" angle iron as shown in the following figure. If the furnace is installed in a crawl space it must also be suspended from the floor joist or supported by a concrete pad. Never install the furnace on the ground or allow it to be exposed to water. The length of rod will depend on the application and the clearances necessary.

SYSTEM OPERATION

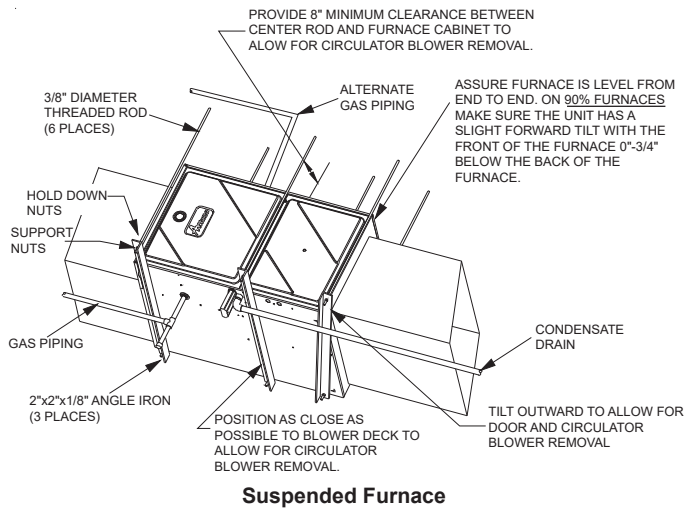

EXISTING FURNACE REMOVAL

NOTE: When an existing furnace is removed from a venting system serving other appliances, the venting system may be too large to properly vent the remaining attached appliances.

The following vent testing procedure is reproduced from the **American National Standard/National Standard of Canada for Gas-Fired Central Furnaces ANSI Z21.47, latest edition, CSA-2.3b, latest edition Section 1.23.1.**

The following steps shall be followed with each appliance connected to the venting system placed in operation, while any other appliances connected to the venting system are not in operation:

- Seal any unused openings in the venting system;
- Inspect the venting system for proper size and horizontal pitch, as required by the National Fuel Gas Code, ANSI Z223.1 or the CSA B149 Installation Codes and these instructions. Determine that there is no blockage or restriction, leakage, corrosion and other deficiencies which could cause an unsafe condition.
- In so far as practical, close all building doors and windows and all doors between the space in which the appliance(s) connected to the venting system are located and other spaces of the building. Turn on clothes dryers and any appliance not connected to the venting system. Turn on any exhaust fans, such as range hoods and bathroom exhausts, so they shall operate at maximum speed. Do not operate a summer exhaust fan. Close fireplace dampers;
- Follow the lighting instructions. Place the appliance being inspected in operation. Adjust thermostat so appliance shall operate continuously;
- Test for draft hood equipped spillage at the draft hood relief opening after 5 minutes of main burner operation. Use the flame of a match or candle.

- After it has been determined that each appliance connected to the venting system properly vents when tested as outlined above, return doors, windows, exhaust fans, fireplace dampers and any other gas burning appliance to their previous conditions of use;
- If improper venting is observed during any of the above tests, the common venting system must be corrected.

Corrections must be in accordance with the latest edition of the National Fuel Gas Code NFPA 54/ANSI Z223.1 and/or CSA B149 Installation Codes.

If resizing is required on any portion of the venting system, use the appropriate table in Appendix G in the latest edition of the National Fuel Gas Code ANSI Z223.1 and/or CSA B149 *Installation Codes*.

THERMOSTAT REQUIREMENTS

A high quality single stage thermostat with a common terminal is recommended.

THERMOSTAT LOCATION

In an area having good air circulation, locate the thermostat and dehumidistat (if applicable) about five feet high on a vibration-free inside wall. Do not install the thermostat or dehumidistat where it may be influenced by any of the following:

- Drafts, or dead spots behind doors, in corners, or under cabinets.
- Hot or cold air from registers.
- Radiant heat from the sun.
- Light fixtures or other appliances.
- Radiant heat from a fireplace.
- Concealed hot or cold water pipes, or chimneys.
- Unconditioned areas behind the thermostat and dehumidistat, such as an outside wall.

Consult the instructions packaged with the thermostat and dehumidistat for mounting instructions and further precautions.

COMBUSTION AND VENTILATION AIR REQUIREMENTS



WARNING

POSSIBLE PROPERTY DAMAGE, PERSONAL INJURY OR DEATH MAY OCCUR IF THE FURNACE IS NOT PROVIDED WITH ENOUGH FRESH AIR FOR PROPER COMBUSTION AND VENTILATION OF FLUE GASES. MOST HOMES REQUIRE OUTSIDE AIR BE SUPPLIED TO THE FURNACE AREA.

Improved construction and additional insulation in buildings have reduced heat loss by reducing air infiltration and escape around doors and windows. These changes have helped in reducing heating/cooling costs but have created a problem supplying combustion and ventilation air for gas fired and other fuel burning appliances. Appliances that pull air out of the house (clothes dryers, exhaust fans, fireplaces, etc.) increase the problem by starving appliances for air.

SYSTEM OPERATION

If this furnace is to be installed in the same space with other gas appliances, such as a water heater, ensure there is an adequate supply of combustion and ventilation air for the other appliances. Refer to the latest edition of the National Fuel Gas Code NFPA 54/ANSI Z223.1 (Section 9.3), or CAN/CGA B149 Installation Codes (Sections 7.2, 7.3, or 7.4), or applicable provisions of the local building codes for determining the combustion air requirements for the appliances.

Most homes will require outside air be supplied to the furnace area by means of ventilation grilles or ducts connecting directly to the outdoors or spaces open to the outdoors such as attics or crawl spaces.

The following information on air for combustion and ventilation is reproduced from the **National Fuel Gas Code NFPA 54/ANSI Z223.1 Section 9.3.**

9.3* Air for Combustion and Ventilation.

9.3.1 General.

9.3.1.1 Air for combustion, ventilation, and dilution of flue gases for appliances installed in buildings shall be obtained by application of one of the methods covered in 9.3.2 through 9.3.6. Where the requirements of 9.3.2 are not met, outdoor air shall be introduced in accordance with methods covered in 9.3.3 through 9.3.6.

Exception No. 1: This provision shall not apply to direct vent appliances.

9.3.1.2 Appliances of other than natural draft design and other than Category 1 vented appliances shall be provided with combustion, ventilation, and dilution air in accordance with the appliance manufacturer's instructions.

9.3.1.3 Appliances shall be located so as not to interfere with proper circulation of combustion, ventilation, and dilution air.

9.3.1.4 Where used, a draft hood or a barometric draft regulator shall be installed in the same room or enclosure as the appliance served so as to prevent any difference in pressure between the hood or regulator and the combustion air supply.

9.3.1.5 Makeup air requirements for the operation of exhaust fans, kitchen ventilation systems, clothes dryers, and fireplaces shall be considered in determining the adequacy of a space to provide combustion air requirements.

9.3.2 Indoor Combustion Air. The required volume of indoor air shall be determined in accordance with the method in 9.3.2.1 or 9.3.2.2 except that where the air infiltration rate is known to be less than 0.40 ACH, the method in 9.3.2.2 shall be used. The total required volume shall be the sum of the required volume calculated for all appliances located within the space. Rooms communicating directly with the space in which the appliances are installed through openings not furnished with doors, and through combustion air openings sized and located in accordance with 9.3.2.3, are considered a part of the required volume.

9.3.2.1* Standard Method. The minimum required volume shall be 50 ft³ per 1,000/Btu/hour (4.8m³/kW).

9.3.2.2* Known Air Infiltration Rate Method. Where the air infiltration rate of a structure is known, the minimum required volume shall be determined as follows:

(1) For appliances other than fan-assisted, calculate using the following equation:

$$\text{Required Volume}_{\text{other}} \geq \frac{21 \text{ ft}^3}{\text{ACH}} \frac{I_{\text{other}}}{1000 \text{ Btu/hr}}$$

(2) For fan-assisted appliances, calculate using the following equation:

$$\text{Required Volume}_{\text{fan}} \geq \frac{15 \text{ ft}^3}{\text{ACH}} \frac{I_{\text{fan}}}{1000 \text{ Btu/hr}}$$

where:

I_{other} = all appliances other than fan-assisted input in Btu per hour

I_{fan} = fan-assisted appliances input in Btu per hour

ACH = air change per hour (percent of volume of space exchanged per hour, expressed as a decimal)

(3) For purposes of this calculation, an infiltration rate greater than 0.60 ACH shall not be used in the equations in 9.3.2.2(1) and 9.3.2.2(2).

9.3.2.3 Indoor Opening Size and Location. Openings used to connect indoor spaces shall be sized and located in accordance with the following:

(1)**Combining spaces on the same story.* Each opening shall have a minimum free area of 1 in.²/1000Btu/hr (2200 mm²/kW) of the total input rating of all appliances in the space but not less than 100 in.² (0.60m²). One opening shall commence within 12 in. (300 mm) of the top, and one opening shall commence within 12 in. (300 mm) of the bottom, of the enclosure [see Figure A.9.3.2.3(1)]. The minimum dimension of air openings shall be not less than 3 in. (80 mm).

NOTE: Each opening must have a free area of not less than one square inch per 1000 BTU of the total input rating of all equipment in the enclosure, but not less than 100 square inches.

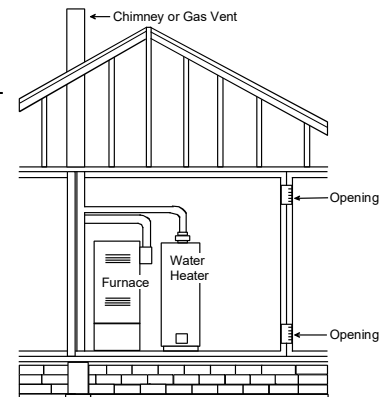

Figure A.9.2.3.3.(1) All Combustion Air from Adjacent Indoor Spaces through Indoor Combustion Air Openings.

SYSTEM OPERATION

(2) *Combining spaces in different stories.* The volumes of spaces in different stories shall be considered as communicating spaces where such spaces are connected by one or more openings in doors or floors having a total minimum free area of 2 in.²/1000 Btu/hr (4400 mm²/kW) of total input rating of all appliances.

9.3.3 Outdoor Combustion Air. Outdoor combustion air shall be provided through opening(s) to the outdoors in accordance with the methods in 9.3.3.1 or 9.3.3.2. The minimum dimension of air openings shall not be less than 3 in. (80 mm).

9.3.3.1 Two Permanent Openings Method. Two permanent openings, one commencing within 12 in. (300 mm) of the top and one commencing within 12 in. (300 mm) of the bottom, of the enclosure shall be provided. The openings shall communicate directly, or by ducts, with the outdoors or spaces that freely communicate with the outdoors, as follows:

(1)*Where directly communicating with the outdoors or where communicating to the outdoors through vertical ducts, each opening shall have a minimum free area of 1 in.²/4000 Btu/hr (550 min²/kW) of total input rating of all appliances in the enclosure. [See Figure A.9.3.3.1(1)(a) and Figure A.9.3.3.1(1)(b).]

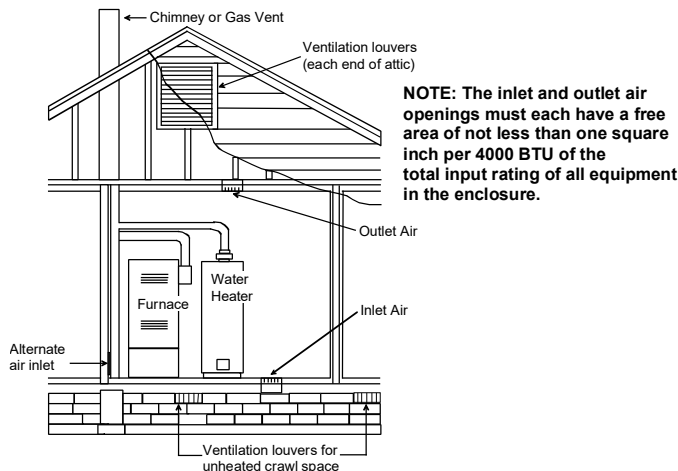

Figure A.9.3.3.1(1)(a) All Combustion Air From Outdoors - Inlet Air from Ventilated Crawl Space and Outlet Air to Ventilated Attic.

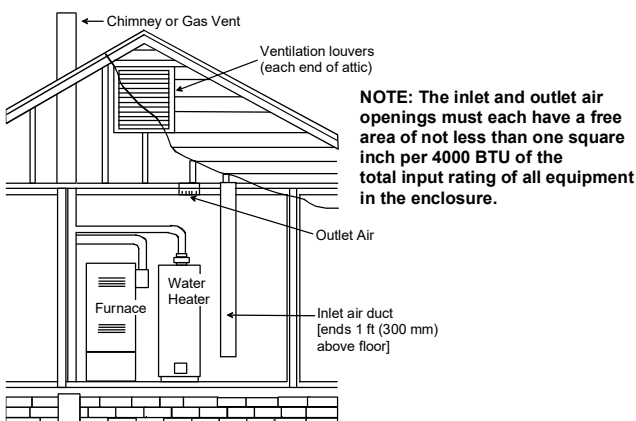

Figure A.9.3.3.1(1)(b) All Combustion Air From Outdoors through Ventilated Attic.

(2)*Where communicating with the outdoors through horizontal ducts, each opening shall have a minimum free area of 1 in.²/2000 Btu/hr (1100 min²/kW) of total input rating of all appliances in the enclosure. [See Figure A.9.3.3.1(2).]

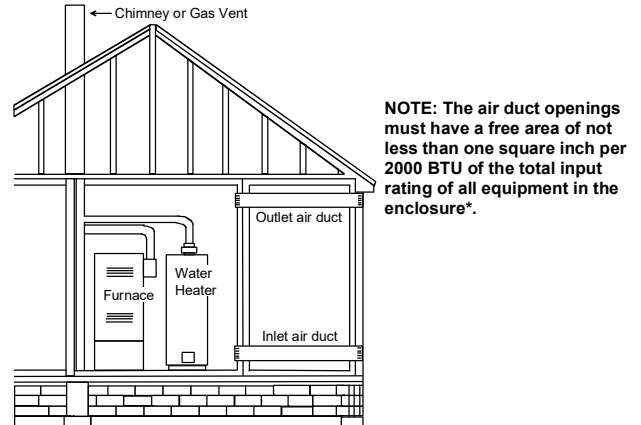

Figure A.9.3.3.1(2) All Combustion Air From Outdoors through Horizontal Ducts.

9.3.3.2* One Permanent Opening Method. One permanent openings, commencing within 12 in. (300 mm) of the top of the enclosure, shall be provided. The appliance shall have clearances of at least 1 in. (25 mm) from the sides and back and 6 in. (150 mm) from the front of the appliance. The opening shall directly communicate with the outdoors or shall communicate through a vertical or horizontal duct to the outdoors or spaces that freely communicate with the outdoors (see Figure A.9.3.3.2) and shall have a minimum free area of the following:

- (1) 1 in.²/3000 Btu/hr (700 mm² per kW) of the total input rating of all appliances located in the enclosure, and
- (2) Not less than the sum of the areas of all vent connectors in the space.

NOTE: The single opening must have a free area of not less than one square inch per 3000 BTU of the total input rating of all equipment in the enclosure, but not less than the sum of the areas of all vent connectors in the confined space.

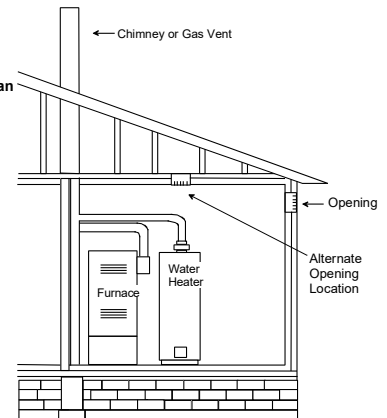

Figure A.9.3.3.2 All Combustion Air From Outdoors through Single Combustion Air Opening.

9.3.4 Combination Indoor and Outdoor Combustion Air. The use of a combination of indoor and outdoor combustion air shall be in accordance with (1) through (3) (see example calculation in Annex JJ):

- (1) *Indoor Openings:* Where used, openings connecting the interior spaces shall comply with 9.3.2.3.
- (2) *Outdoor Opening(s) Location.* Outdoor opening(s) shall be located in accordance with 9.3.3.

SYSTEM OPERATION

(3) **Outdoor Opening(s) Size.** The outdoor opening(s) size shall be calculated in accordance with the following:

- (a) The ratio of the interior spaces shall be the available volume of all communicating spaces divided by the required volume.
- (b) The outdoor size reduction factor shall be 1 minus the ratio of interior spaces.
- (c) The minimum size of outdoor opening(s) shall be the full size of outdoor opening(s) calculated in accordance with 9.3.3, multiplied by the reduction factor. The minimum dimension of air openings shall not be less than 3 in. (80 mm).

9.3.5 Engineered Installations. Engineered combustion air installations shall provide an adequate supply of combustion, ventilation, and dilution air and shall be approved by the authority having jurisdiction.

9.3.6 Mechanical Combustion Air Supply. Where all combustion air is provided by a mechanical air supply system, the combustion air shall be supplied from outdoors at the minimum rate of 0.35 ft³/min per 1000 Btu/hr (0.034 m³/min per kW) for all appliances located within the space.

9.3.6.1 Where exhaust fans are installed, additional air shall be provided to replace the exhausted air.

9.3.6.2 Each of the appliances served shall be interlocked to the mechanical air supply system to prevent main burner operation where the mechanical air supply system is not in operation.

9.3.6.3 Where combustion air is provided by the building's mechanical ventilation system, the system shall provide the specified combustion air rate in addition to the required ventilation air.

9.3.7 Louvers, Grilles, and Screens.

9.3.7.1 Louvers and Grilles. The required size of openings for combustion, ventilation, and dilution air shall be based on the net free area of each opening. Where the free area through a design of louver or grille or screen is known, it shall be used in calculating the size opening required to provide the free area specified. Where the louver and grille design and free area are not known, it shall be assumed that wood louvers will have 25 percent free area, and metal louvers and grilles will have 75 percent free area. Nonmotorized louvers and grilles shall be fixed in the open position.

9.3.7.2 Minimum Scree Mesh Size. Screens shall not be smaller than 1/4 in. mesh.

9.3.7.3 Motorized Louvers. Motorized louvers shall be interlocked with the appliance so they are proven in the full open position prior to main burner ignition and during main burner operation. Means shall be provided to prevent the main burner from igniting should the louver fail to open during burner startup and to shut down the main burner if the louvers close during burner operation.

9.3.8 Combustion Air Ducts. Combustion air ducts shall comply with 9.3.8.1 through 9.3.8.8.

9.3.8.1 Ducts shall be constructed of galvanized steel or a material having equivalent corrosion resistance, strength, and rigidity.

Exception: Within dwellings units, unobstructed stud and joist spaces shall not be prohibited from conveying combustion air, provided that not more than one fireblock is removed.

9.3.8.2 Ducts shall terminate in an unobstructed space, allowing free movement of combustion air to the appliances.

9.3.8.3 Ducts shall serve a single space.

9.3.8.4 Ducts shall not serve both upper and lower combustion air openings where both such openings are used. The separation between ducts servicing upper and lower combustion air openings shall be maintained to the source of combustion air.

9.3.8.5 Ducts shall not be screened where terminating in an attic space.

9.3.8.6 Horizontal upper combustion air ducts shall not slope downward toward the source of combustion air.

9.3.8.7 The remaining space surrounding a chimney liner, gas vent, special gas vent, or plastic piping installed within a masonry, metal, or factory built chimney shall not be used to supply combustion air.

Exception: Direct vent appliances designed for installation in a solid fuel-burning fireplace where installed in accordance with the manufacture's installation instructions.

9.3.8.8 Combustion air intake openings located on the exterior of the building shall have the lowest side of the combustion air intake openings located at least 12 in. (300 mm) vertically from the adjoining grade level.

CATEGORY I VENTING (VERTICAL VENTING) (80% FURNACES ONLY)

 WARNING
TO PREVENT POSSIBLE PERSONAL INJURY OR DEATH DUE TO ASPHYXIATION, NON-CONDENSING GAS FIRED WARM AIR FURNACES MUST BE CATEGORY I VENTED. DO NOT VENT ANY OF THESE FURNACES USING CATEGORY III VENTING.

Category I Venting is venting at a non-positive pressure. A furnace vented as Category I is considered a fan-assisted appliance and does not have to be "gas tight". **NOTE:** Single-Stage and Two-Stage gas furnaces with induced draft blowers draw products of combustion through a heat exchanger allowing in some instances common venting with natural draft appliances (i.e. water heaters).

All installations must be vented in accordance with National Fuel Gas Code NFPA 54/ANSI Z223.1 - latest edition. In Canada, the furnaces must be vented in accordance with the National Standard of Canada, CAN/CGA B149.1 and CAN/CGA B149.2 - latest editions and amendments.

SYSTEM OPERATION

NOTE: The vertical height of the Category I venting system must be at least as great as the horizontal length of the venting system.

 WARNING
<p>TO PREVENT POSSIBLE DEATH OR PERSONAL INJURY DUE TO ASPHYXIATION, COMMON VENTING WITH OTHER MANUFACTURER'S INDUCED DRAFT APPLIANCES IS NOT ALLOWED.</p>

When an existing furnace is removed from a venting system serving other appliances, the venting system may be too large to properly vent the remaining attached appliances. For complete details refer to *Existing Furnace Removal* section of this manual.

When resizing any portion of the common venting system, use the appropriate table in Appendix G in the latest edition of the National Fuel Gas Code NFPA 54/ANSI Z223.1.

Upflow or Horizontal units are shipped with the induced draft blower discharging from the top of the furnace ("Top" is as viewed for an upflow installation). The induced draft blower can be rotated 90 degrees for Category I venting. Refer to the following figure. For horizontal installations, a four inch single wall pipe can be used to extend the induced draft blower outlet 1/2" beyond the furnace cabinet. Vent the furnace in accordance with the National Fuel Gas Code NFPA 54/ANSI Z223.1 - latest edition. In Canada, vent the furnace in accordance with the National Standard of Canada, CAN/CGA B149.1 and CAN/CGA B149.2 - latest editions and amendments.

 WARNING
<p>TO PREVENT DEATH OR SERIOUS ILLNESS TO BUILDING OCCUPANTS DUE TO FLUE PRODUCTS LEAKING INTO THE BUILDING, PROPER INSTALLATION OF GASKETS AND SCREWS IS ESSENTIAL FOR PROVIDING A GAS TIGHT SEAL BETWEEN THE PARTITION PANEL AND THE INDUCED DRAFT BLOWER.</p>

Make sure all wires are at least one inch from flue pipe. Relocate junction box to right side of cabinet if necessary. Refer to *Electrical Connections* section of this manual for instructions.

MASONRY CHIMNEYS

 WARNING
<p>POSSIBILITY OF PROPERTY DAMAGE, PERSONAL INJURY OR DEATH - DAMAGING CONDENSATION CAN OCCUR INSIDE MASONRY CHIMNEYS WHEN A SINGLE FAN ASSISTED CATEGORY 1 APPLIANCE (80% AFUE FURNACE) IS VENTED WITHOUT ADEQUATE DILUTION AIR. DO NOT CONNECT AN 80% FURNACE TO A MASONRY CHIMNEY UNLESS THE FURNACE IS COMMON VENTED WITH THE DRAFT HOOD EQUIPPED APPLIANCE, OR THE CHIMNEY IS LINED WITH A METAL LINER OR B METAL VENT. ALL INSTALLATIONS USING MASONRY CHIMNEYS MUST BE SIZED IN ACCORDANCE WITH THE APPROPRIATE VENTING TABLES.</p> <p>- IF AN 80% FURNACE IS COMMON VENTED WITH THE DRAFT HOOD EQUIPPED APPLIANCE, THE POTENTIAL FOR CONDENSATION DAMAGE MAY STILL EXIST WITH EXTREMELY COLD CONDITIONS, LONG VENT CONNECTORS, EXTERIOR CHIMNEYS, OR ANY COMBINATION OF THESE CONDITIONS, THE RISK OF CONDENSATION DAMAGE IS BEST AVOIDED BY USING THE MASONRY CHIMNEY AS A PATHWAY FOR PROPERLY SIZED METAL LINER OR B METAL VENT.</p>

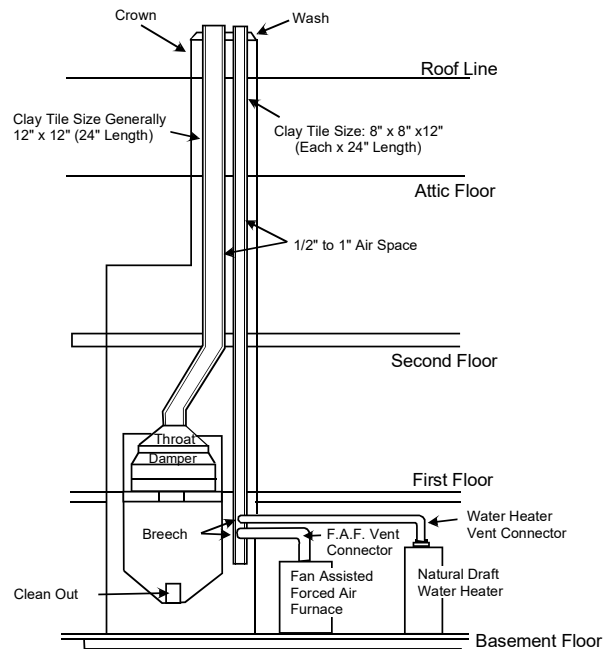

Typical Multiple Flue Clay Tile Chimney

CHECKLIST SUMMARY

This checklist serves as a summary of the items to be checked before venting an 80% furnace into a masonry chimney. In addition, we recommend that a qualified serviceman use this checklist to perform a yearly inspection of the furnace venting system.

This checklist is only a summary. For detailed information on each of the procedures mentioned, see the paragraph referenced with each item.

This inspection is based upon a draft topical report, "Masonry Chimney Inspection and Relining", issued by the Gas Research Institute. While not yet finalized, we believe this report represents the best information on this subject which is currently available.

SYSTEM OPERATION

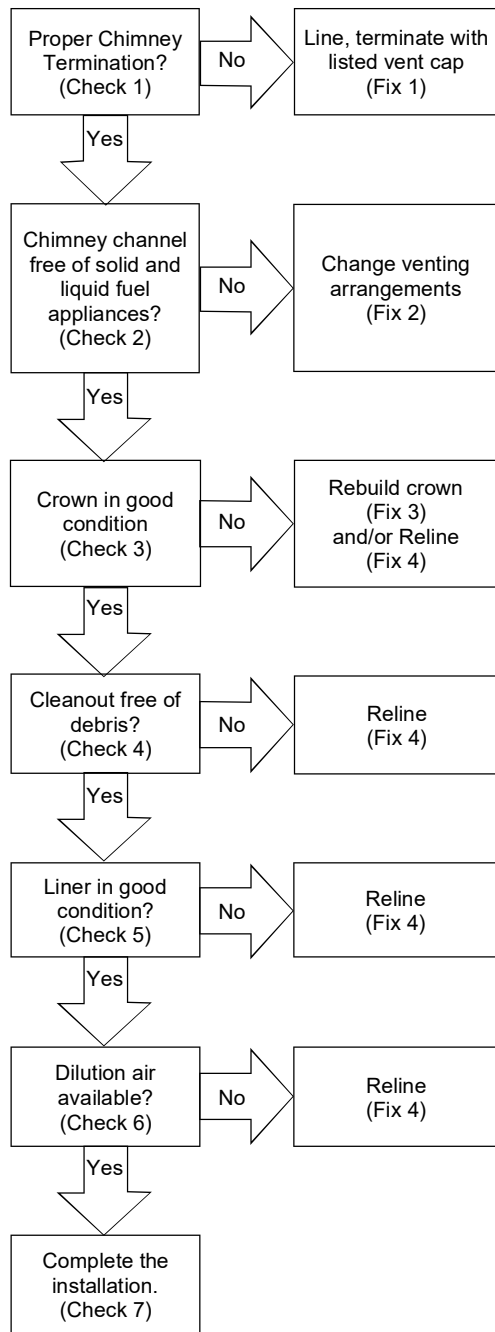

CHECK 1 - PROPER CHIMNEY TERMINATION

A masonry chimney used as a vent for gas fired equipment must extend at least three feet above the highest point where it passes through the roof. It must extend at least two feet higher than any portion of a building within a horizontal distance of 10 feet. In addition, the chimney must terminate at least 3 feet above any forced air inlet located within 10 feet. The chimney must extend at least five feet above the highest connected equipment draft hood outlet or flue collar. If the chimney does not meet these termination requirements, but all other requirements in the checklist can be met, it may be possible for a mason to extend the chimney. If this will not be practical, see Fix 1.

CHECK 2 - ANY SOLID OR LIQUID FUEL APPLIANCES VENT-ED INTO THIS CHIMNEY CHANNEL

Solid fuel appliances include fireplaces, wood stoves, coal furnaces, and incinerators. Liquid fuel appliances include oil furnaces, oil-fired boilers and oil-fired water heaters. Appliances which burn propane (sometimes referred to as LP (liquefied petroleum) gas) are considered gas-fired appliances.

CHECK 3 - CHIMNEY CROWN CONDITION

Damage from condensate usually shows up first in the crown. If any of the following trouble signs are present, the condition of the crown is not satisfactory:

- a. Crown leaning
- b. Bricks missing
- c. Mortar missing

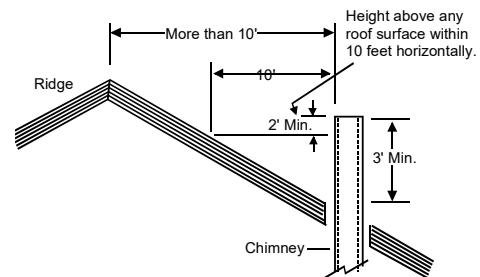
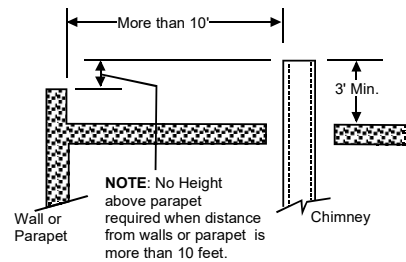
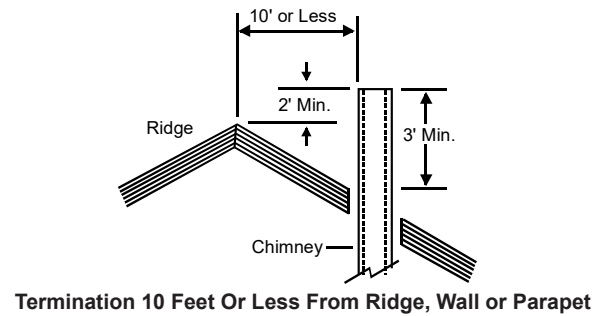
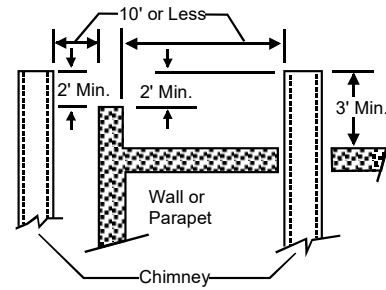

SYSTEM OPERATION

- d. Tile liner cracked
- e. No tile liner
- f. Salt staining at mortar joints. (White stains, and mortar becomes sandy and/or erodes.)

For problems a, b, or c, see Fix 3. If problems d, e, or f are present, see Fix 4. **IMPORTANT:** It may be necessary to follow both Fix 3 and Fix 4.

CHECK 4 - DEBRIS IN CLEANOUT

A cleanout (dropleg) must be present such that the upper edge of the cleanout cover is at least 12 inches below the lower edge of the lowest chimney inlet opening.

A chimney without a cleanout could become partially blocked by debris. If no cleanout is present, the chimney must be relined (Fix 4).

Remove the cleanout cover, and examine the cleanout for debris. If significant amounts of any of the following are found:

- Fuel oil residue
- Bricks
- Mortar or sand
- Pieces of the tile liner
- Rusted pieces of the metallic liner reline the chimney (Fix 4).

CHECK 5 - LINER CONDITION

If a metal liner is present, it must be checked. It cannot be assumed that all existing metal liners are correctly installed and in good condition.

Remove the lowest existing vent connector, and examine the inside of the elbow or tee at the base of the liner. A small amount of soot may be considered acceptable, provided the installer vacuums it away. If rusted pieces of the liner have collected here, the metal liner must be removed and replaced (Fix 4).

Next, gently tap the inside of the liner with a Phillips screwdriver. If the screwdriver perforates the liner, or if the tapping does not sound like metal hitting metal, the liner must be removed and replaced (Fix 4).

Remember that all appliances must be vented inside the liner. Venting one appliance inside the liner and another appliance outside the liner is not acceptable.

Next, use a flashlight and small mirror to sight up the liner. B vent must be supported so as to not come into direct contact with the chimney walls or tile liner. If it is not, it can probably be rehung so as to be acceptable. A thimble or fire stop may be helpful here.

Flexible liners should be hung straight or nearly straight. If it is spiraled in the chimney and in good condition, it should be rehung. To do this, break the top seal; pull up and cut off the excess liner length, and refit the top seal. Use caution when doing this, as the cut edges of flexible liners may be sharp.

The surfaces of the liner must be physically sound. If gaps or holes are present, the metal liner must be removed and replaced (Fix 4).

Finally, confirm that the metal liner is the correct size for the appliances to be installed. Use the GAMA tables and rules. If a metal liner is not present, a clay tile liner must be present, or the chimney must be lined (Fix 4).

Use a flashlight and small mirror at the cleanout or vent connector to inspect the clay tile liner. If any of the following problems are present:

- Tile sections misaligned
- Tile sections missing
- Gaps between tile sections
- Signs of condensate drainage at the cleanout or vent connectors
- Mortar protruding from between tile sections
- Use of sewer pipe or drainage pipe rather than an approved fire clay tile reline the chimney (Fix 4).

Next, measure the size of the liner. It may be possible to do this from the cleanout. The liner must be at least as large as the minimum size established by the tables in National Fuel Gas Code NFPA 54/ANSI Z223.1 - latest edition and in the National Standard of Canada, CAN/CGA B149.1 and CAN/CGA B149.2 - latest editions and amendments. If the liner is too small or too large, then the chimney must be relined (Fix 4).

CHECK 6 - DILUTION AIR

If gas-fired appliances are to be vented into a clay tile liner, a source of dilution air is required.

Dilution air cannot be obtained through:

- Induced draft appliances
- Natural draft appliances with vent dampers

Sufficient dilution air can ordinarily be obtained through the draft hood of a natural draft appliance only if the appliance's vent connector does not include a vent damper.

If dilution air will not be available, the chimney must be relined (Fix 4).

SYSTEM OPERATION

CHECK 7 - COMPLETE THE INSTALLATION

If Checks 1 through 6 have been satisfactory, and the liner is an acceptable size as determined by the tables in National Fuel Gas Code NFPA 54/ANSI Z223.1 - latest edition and in the National Standard of Canada, CAN/CGA B149.1 and CAN/CGA B149.2 - latest editions and amendments, then the clay tile liner can probably be used as a vent for the gas appliances. However, the installer must keep in mind the following factors which may render the tile liner unsuitable for use as a vent:

- Extremely cold weather
- Long vent connectors
- Masonry chimneys with no air gap between the liner and the bricks. (In practice, this can be difficult to detect.)
- Exterior chimneys (The tables in National Fuel Gas Code NFPA 54/ANSI Z223.1 - latest edition and in the National Standard of Canada, CAN/CGA B149.1 and CAN/CGA B149.2 - latest editions and amendments assume interior chimneys.)

If in the judgment of the local gas utility, installer, and/or local codes, one or more of the above factors is likely to present a problem; the chimney must be relined (Fix 4).

FIX 1 - LINER TERMINATION

Any cap or roof assembly used with a liner must be approved by the liner manufacturer for such use. The liner and cap/roof assembly must then terminate above the roof in accordance with the manufacturer's instructions.

In some cases, a shorter extension above the roof may be possible with a liner than would be required with a masonry chimney. For further information on relining, see Fix 4.

FIX 2 - CHANGE VENTING ARRANGEMENTS

If the masonry chimney has more than one channel, it may be possible to vent the gas appliances into one channel and vent the solid or liquid fuel appliance(s) into another channel(s). Do not vent an 80% furnace inside of a metal liner with other appliances vented outside the liner.

Alternatively, the homeowner may agree to discontinue use of the fireplace (solid fuel appliance). If so, the tile liner must be cleaned to remove creosote buildup. The fireplace opening must then be permanently sealed.

If oil-fired appliance(s) are being replaced by gas-fired appliance(s), the tile liner must first be cleaned to remove the fuel oil residue.

If none of the above options are practical, the 80% furnace may need to be vented vertically with B vent.

Under some conditions a 90%+ furnace could be installed rather than an 80%. The 90% furnace can be vented horizontally or vertically through PVC pipe.

FIX 3 - REBUILD THE CROWN

If the chimney crown is damaged, a qualified mason must repair it in accordance with nationally recognized building codes or standards. One such standard which may be referenced is the Standard for Chimneys, Fireplaces, Vents, and Solid Fuel Burning Appliances, ANSI/NFPA 211.

FIX 4 - RELINING

RELINING OPTIONS INCLUDE B VENT AND FLEXIBLE LINERS.

If the chimney has diagonal offsets, B vent probably cannot be used.

If B vent is to be used, it must be supported adequately. Supports (such as fire stops or thimbles) must be used to prevent the B vent from coming into direct contact with the tile liner or chimney walls. Direct contact would result in higher heat loss, with an increased possibility of poor venting system performance.

It is not acceptable to vent one appliance inside the B vent and other appliances outside. The excess space between the B vent and the chimney walls must be covered at the top of the chimney by a weatherproof, corrosion resistant flashing.

The B vent should then be topped with a listed vent cap. The listed vent cap will, when installed per the manufacturer's instructions, prevent problems due to rain, birds, or wind effects.

A B vent installed as described in this section is considered to be an enclosed vent system, and the sizing tables in National Fuel Gas Code NFPA 54/ANSI Z223.1 - latest edition and in the National Standard of Canada, CAN/CGA B149.1 and CAN/CGA B149.2 - latest editions and amendments may be used.

If a flexible liner is to be used, it must be made of the proper materials:

- For most residential applications, an aluminum liner should be acceptable.
- If the combustion air supplied to the furnace will be contaminated with compounds containing chlorine or fluorine, a liner of AL29-4C stainless steel should be used. Common sources of chlorine and fluorine compounds include indoor swimming pools and chlorine bleaches, paint strippers, adhesives, paints, varnishes, sealers, waxes (which are not yet dried) and solvents used during construction and remodeling. Various commercial and industrial processes may also be sources of chlorine/fluorine compounds.
- Heavier gauge 300 and 400 series stainless steel liners were developed for use with oil or solid fuel appliances. They are not suitable for use with gas-fired appliances. Flexible liners specifically intended and tested for gas applications are listed in the UL "Gas and Oil Equipment Directory" (UL Standard 1777).

SYSTEM OPERATION

For sizing of flexible liners, see Note 22 and the tables in the National Fuel Gas Code NFPA 54/ANSI Z223.1 - latest edition and in the National Standard of Canada, CAN/CGA B149.1 and CAN/CGA B149.2 - latest editions and amendments.

To install the liner, read and follow the liner manufacturer's instructions and your local codes. Excess liner length should be pulled out of the chimney and cut off. Use caution when doing this, as the cut edges of flexible liners may be sharp. Do not spiral excess liner inside of the chimney. Support the liner as recommended by the liner manufacturer.

Some manufacturers of flexible liners offer an insulation sleeve designed to be added to the liner before it is installed in the chimney. (Poured insulation, either vermiculite or other materials, is no longer recommended.) Insulation will need to be added to the flexible liner if:

- It is required by the liner manufacturer's instructions.
- The previous liner was properly sized and installed, and suffered from condensation damage.
- It is required by your local building codes.

Even if none of those three conditions exist which require additional liner insulation, the installer may wish to consider it if:

- The local climate is very cold.
- The chimney is very tall.
- The vent connectors used are very long or have a large number of elbows.
- Local experience indicates that flexible liners installed without insulation are likely to have condensation problems.

Insulation must be selected and installed in accordance with the liner manufacturer's instructions.

Finally, cap the chimney and terminate the liner in accordance with the liner manufacturer's instructions.

HORIZONTAL APPLICATIONS AND CONSIDERATIONS

Horizontal applications, in particular, may dictate many of the installation's specifics such as airflow direction, ductwork connections, and flue pipe connections.

ALTERNATE ELECTRICAL AND GAS LINE CONNECTIONS

Furnaces have provisions allowing for electrical and gas line connections through either side panel. In horizontal applications the connections can be made either through the "top" or "bottom" of the furnace.

PROPANE GAS AND/OR HIGH ALTITUDE INSTALLATIONS

 WARNING
<p>POSSIBLE PROPERTY DAMAGE, PERSONAL INJURY OR DEATH MAY OCCUR IF THE CORRECT CONVERSION KITS ARE NOT INSTALLED. THE APPROPRIATE KITS MUST BE APPLIED TO ENSURE SAFE AND PROPER FURNACE OPERATION. ALL CONVERSIONS MUST BE PERFORMED BY A QUALIFIED INSTALLER OR SERVICE AGENCY.</p>

This furnace is shipped from the factory configured for natural gas at standard altitude. Propane gas installations require an orifice change to compensate for the energy content difference between natural and propane gas.

High altitude installations may require both a pressure switch and an orifice change. These changes are necessary to compensate for the natural reduction in the density of both the gas fuel and the combustion air at higher altitude. Refer to the *Accessories Charts* in this manual or product Specification Sheet for a tabular listing of appropriate manufacturer's kits for propane gas and/or high altitude installations. The indicated kits must be used to insure safe and proper furnace operation. All conversions must be performed by a qualified installer, or service agency.

 WARNING
<p>FAILURE TO FOLLOW THESE INSTRUCTIONS CAN RESULT IN BODILY INJURY OR DEATH. CAREFULLY READ AND FOLLOW ALL INSTRUCTIONS GIVEN IN THIS SECTION.</p>

 WARNING
<p>UPON COMPLETION OF THE FURNACE INSTALLATION, CAREFULLY INSPECT THE ENTIRE FLUE SYSTEM BOTH INSIDE AND OUTSIDE THE FURNACE TO ASSURE IT IS PROPERLY SEALED. LEAKS IN THE FLUE SYSTEM CAN RESULT IN SERIOUS PERSONAL INJURY OR DEATH DUE TO EXPOSURE TO FLUE PRODUCTS INCLUDING CARBON MONOXIDE.</p>

GAS SUPPLY AND PIPING

The furnace rating plate includes the approved furnace gas input rating and gas types. The furnace must be equipped to operate on the type of gas applied. This includes any conversion kits required for alternate fuels and/or high altitude.

 CAUTION
<p>TO PREVENT UNRELIABLE OPERATION OR EQUIPMENT DAMAGE, THE INLET GAS SUPPLY PRESSURE MUST BE AS SPECIFIED ON THE UNIT RATING PLATE WITH ALL OTHER HOUSEHOLD GAS FIRED APPLIANCES OPERATING.</p>

Inlet gas supply pressures must be maintained within the ranges specified below. The supply pressure must be constant and available with all other household gas fired appliances operating. The minimum gas supply pressure must be maintained to prevent unreliable ignition. The maximum must not be exceeded to prevent unit overfiring.

INLET GAS SUPPLY PRESSURE		
Natural Gas	Minimum: 4.5" w.c.	Maximum: 10.0" w.c.
Propane Gas	Minimum: 11.0" w.c.	Maximum: 13.0" w.c.

HIGH ALTITUDE DERATE

When this furnace is installed at high altitude, the appropriate High Altitude orifice kit must be applied. This is required due to the natural reduction in the density of both the gas fuel and combustion air as altitude increases. The kit will

SYSTEM OPERATION

provide the proper design certified input rate within the specified altitude range.

High altitude kits are purchased according to the installation altitude and usage of either natural or propane gas. Refer to the product Specification Sheet or Technical Manual for a tabular listing of appropriate altitude ranges and corresponding manufacturer's high altitude (Natural, Propane gas, and/or Pressure Switch) kits.

Do **not** derate the furnace by adjusting the manifold pressure to a lower pressure than specified on the furnace rating plate. The combination of the lower air density and a lower manifold pressure will prohibit the burner orifice from drawing the proper amount of air into the burner. This may cause incomplete combustion, flashback, and possible yellow tipping.

In some areas the gas supplier may artificially derate the gas in an effort to compensate for the effects of altitude. If the gas is artificially derated, the appropriate orifice size must be determined based upon the BTU/ft³ content of the derated gas and the altitude. Refer to the National Fuel Gas Code, NFPA 54/ANSI Z223.1, and information provided by the gas supplier to determine the proper orifice size.

A different pressure switch may be required at high altitude regardless of the BTU/ft³ content of the fuel used. Refer to the product Specification Sheet or Technical Manual for a tabular listing of appropriate altitude ranges and corresponding manufacturer's pressure switch kits.

PROPANE GAS CONVERSION

 WARNING
<p>POSSIBLE PROPERTY DAMAGE, PERSONAL INJURY OR DEATH MAY OCCUR IF THE CORRECT CONVERSION KITS ARE NOT INSTALLED. THE APPROPRIATE KITS MUST BE APPLIED TO ENSURE SAFE AND PROPER FURNACE OPERATION. ALL CONVERSIONS MUST BE PERFORMED BY A QUALIFIED INSTALLER OR SERVICE AGENCY.</p>

This unit is configured for natural gas. The appropriate manufacturer's propane gas conversion kit, must be applied for propane gas installations.

- Single-stage 80% furnace models using a Honeywell VR8215 single stage valve or a White-Rodgers 36J22 use LPT-03 LP Conversion Kit.

Refer to the specification sheet for the model you are servicing. Refer to the "propane gas and/or High Altitude Installations" section for details.

GAS VALVE

This unit is equipped with a 24 volt gas valve controlled during furnace operation by the integrated control module. As shipped, the valve is configured for natural gas. The valve is field convertible for use with propane gas by using the appropriate propane gas conversion kit. Taps for mea-

suring the gas supply pressure and manifold pressure are provided on the valve.

NOTE: The gas supply pressure on White-Rodger "J" model gas valve, used on single stage furnaces, can be checked with a gas pressure test kit (Part #0151K00000S) available through our authorized distributors.

The gas valve has a manual ON/OFF control located on the valve itself. This control may be set only to the "ON" or "OFF" position. Refer to the *Lighting Instructions Label* or the "Putting the Furnace Into Operation" section of this manual or the installation instructions for use of this control during start up and shut down periods.

GAS PIPING CONNECTIONS

 CAUTION
<p>TO AVOID POSSIBLE UNSATISFACTORY OPERATION OR EQUIPMENT DAMAGE DUE TO UNDERFIRING OF EQUIPMENT, USE THE PROPER SIZE OF NATURAL/PROPANE GAS PIPING NEEDED WHEN RUNNING PIPE FROM THE METER/TANK TO THE FURNACE.</p>

The gas piping supplying the furnace must be properly sized based on the gas flow required, specific gravity of the gas, and length of the run. The gas line installation must comply with local codes, or in their absence, with the latest edition of the National Fuel Gas Code, NFPA 54/ANSI Z223.1.

Natural Gas Capacity of Pipe In Cubic Feet of Gas Per Hour (CFH)					
Length of Pipe in Feet	Nominal Black Pipe Size				
	1/2"	3/4"	1"	1 1/4"	1 1/2"
10	132	278	520	1050	1600
20	92	190	350	730	1100
30	73	152	285	590	980
40	63	130	245	500	760
50	56	115	215	440	670
60	50	105	195	400	610
70	46	96	180	370	560
80	43	90	170	350	530
90	40	84	160	320	490
100	38	79	150	305	460

(Pressure 0.5 psig or less and pressure drop of 0.3" W.C.; Based on 0.60 Specific Gravity Gas)

$$CFH = \frac{BTUH \text{ Furnace Input}}{\text{Heating Value of Gas (BTU/Cubic Foot)}}$$

To connect the furnace to the building's gas piping, the installer must supply a ground joint union, drip leg, manual shutoff valve, and line and fittings to connect to gas valve. In some cases, the installer may also need to supply a transition piece from 1/2" pipe to a larger pipe size.

The following stipulations apply when connecting gas piping. Refer to the following figures for typical gas line connections to the furnace.

1. Use black iron or steel pipe and fittings for the building piping.
2. Use pipe joint compound on male threads only. Pipe joint compound must be resistant to the action of the fuel used.

SYSTEM OPERATION

3. Use ground joint unions.
4. Install a drip leg to trap dirt and moisture before it can enter the gas valve. The drip leg must be a minimum of three inches long.
5. Install a 1/8" NPT pipe plug fitting, accessible for test gage connection, immediately upstream of the gas supply connection to the furnace.
6. Use two pipe wrenches when making connection to the gas valve to keep it from turning. The orientation of the gas valve on the manifold must be maintained as shipped from the factory.
7. Install a manual shutoff valve between the gas meter and unit within six feet of the unit. If a union is installed, the union must be downstream of the manual shutoff valve, between the shutoff valve and the furnace.
8. Tighten all joints securely.
9. Connect the furnace to the building piping by one of the following methods:
 - Rigid metallic pipe and fittings.
 - Semi-rigid metallic tubing and metallic fittings. Aluminum alloy tubing must not be used in exterior locations. In order to seal the grommet cabinet penetration, rigid pipe must be used to reach the outside of the cabinet. A semi-rigid connector to the gas piping may be used from there.
10. Use listed gas appliance connectors in accordance with their instructions. Connectors must be fully in the same room as the furnace.
11. Protect connectors and semi-rigid tubing against physical and thermal damage when installed. Ensure aluminum-alloy tubing and connectors are coated to protect against external corrosion when in contact with masonry, plaster, or insulation, or subjected to repeated wetting by liquids such as water (except rain water), detergents, or sewage.



CAUTION

EDGES OF SHEET METAL HOLES MAY BE SHARP. USE GLOVES A PRECAUTION WHEN REMOVING HOLE PLUGS.

GAS PIPING CHECKS

Before placing unit in operation, leak test the unit and gas connections.



WARNING

TO AVOID THE POSSIBILITY OF EXPLOSION OR FIRE, NEVER USE A MATCH OR OPEN FLAME TO TEST FOR LEAKS.

Check for leaks using an approved chloride-free soap and water solution, an electronic combustible gas detector, or other approved testing methods.

NOTE: Never exceed specified pressures for testing. Higher pressure may damage the gas valve and cause subsequent overfiring, resulting in heat exchanger failure. Disconnect this unit and shutoff valve from the gas supply piping system be-

fore pressure testing the supply piping system with pressures in excess of 1/2 psig (3.48 kPa). Isolate this unit from the gas supply piping system by closing its external manual gas shut-off valve before pressure testing supply piping system with test pressures equal to or less than 1/2 psig (3.48 kPa).

PROPANE GAS TANKS AND PIPING



WARNING

PROPANE GAS IS HEAVIER THAN AIR AND ANY LEAKING GAS CAN SETTLE IN ANY LOW AREAS OR CONFINED SPACES. TO PREVENT PROPERTY DAMAGE, PERSONAL INJURY, OR DEATH DUE TO FIRE OR EXPLOSION CAUSED BY A PROPANE GAS LEAK, INSTALL A GAS DETECTION WARNING DEVICE.

A gas detecting warning system is the only reliable way to detect a propane gas leak. Iron oxide (rust) can reduce the level of odorant in propane gas. Do not rely on your sense of smell. Contact a local propane gas supplier about installing a gas detecting warning system. If the presence of gas is suspected, follow the instructions on this page.

All propane gas equipment must conform to the safety standards of the National Board of Fire Underwriters, NBFU Manual 58.

For satisfactory operation, propane gas pressure must be 11 inch WC at the furnace manifold with all gas appliances in operation. Maintaining proper gas pressure depends on three main factors:

1. Vaporization rate, depending on temperature of the liquid, and "wetted surface" area of the container or containers.
2. Proper pressure regulation. (Two-stage regulation is recommended for both cost and efficiency).
3. Pressure drop in lines between regulators, and between second stage regulator and the appliance. Pipe size will depend on length of pipe run and total load of all appliances.

Complete information regarding tank sizing for vaporization, recommended regulator settings, and pipe sizing is available from most regulator manufacturers and propane gas suppliers. Always use a pipe sealant approved for natural gas and LP gas.

Refer to the following illustration for typical propane gas installations and piping.

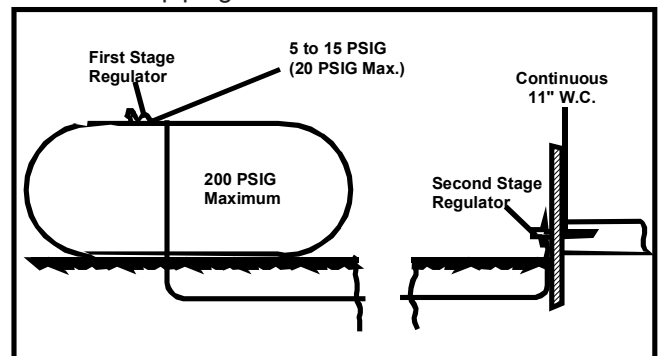

Typical Propane Gas Installation

SYSTEM OPERATION



WARNING

IF THE GAS FURNACE IS INSTALLED IN A BASEMENT, AN EXCAVATED AREA OR A CONFINED SPACE, IT IS STRONGLY RECOMMENDED TO CONTACT A PROPANE SUPPLIER TO INSTALL A GAS DETECTING WARNING DEVICE IN A CASE OF A GAS LEAK.

- SINCE PROPANE GAS IS HEAVIER THAN AIR, ANY LEAKING GAS CAN SETTLE IN ANY LOW AREAS OR CONFINED SPACES.
- PROPANE GAS ODORANT MAY FADE, MAKING THE GAS UNDETECTABLE EXCEPT WITH A WARNING DEVICE.



WARNING

AN UNDETECTABLE GAS LEAK WILL CREATE A DANGER OF EXPLOSION OR FIRE. IF THE PRESENCE OF GAS IS SUSPECTED, FOLLOW THE INSTRUCTIONS ON THE COVER OF THIS MANUAL. FAILURE TO DO SO COULD RESULT IN SERIOUS INJURY OR DEATH.



WARNING

IF THE INFORMATION IN THESE INSTRUCTIONS IS NOT FOLLOWED EXACTLY, A FIRE OR EXPLOSION MAY RESULT CAUSING PROPERTY DAMAGE, PERSONAL INJURY OR LOSS OF LIFE.

- DO NOT STORE OR USE GASOLINE OR OTHER FLAMMABLE VAPORS AND LIQUIDS IN THE VICINITY OF THIS OR ANY OTHER APPLIANCE.
- WHAT TO DO IF YOU SMELL GAS:
 - DO NOT TRY TO LIGHT ANY APPLIANCE.
 - DO NOT TOUCH ANY ELECTRICAL SWITCH; DO NOT USE ANY PHONE IN YOUR BUILDING.
 - IMMEDIATELY CALL YOUR GAS SUPPLIER FROM A NEIGHBOR'S PHONE. FOLLOW THE GAS SUPPLIER'S INSTRUCTIONS. IF YOU CANNOT REACH YOUR GAS SUPPLIER, CALL THE FIRE DEPARTMENT.
- INSTALLATION AND SERVICE MUST BE PERFORMED BY A QUALIFIED INSTALLER, SERVICE AGENCY OR THE GAS SUPPLIER.

Sizing Between First and Second Stage Regulator*

Maximum Propane Capacities listed are based on 2 psig pressure drop at 10 psig setting. Capacities in 1,000 BTU/hour.

Pipe or Tubing Length Feet	Tubing Size, O.D. Type L					Nominal Pipe Size Schedule 40	
	3/8"	1/2"	5/8"	3/4"	7/8"	1/2"	3/4"
10	730	1,700	3,200	5,300	8,300	3,200	7,500
20	500	1,100	2,200	3,700	5,800	2,200	4,200
30	400	920	2,000	2,900	4,700	1,800	4,000
40	370	850	1,700	2,700	4,100	1,600	3,700
50	330	770	1,500	2,400	3,700	1,500	3,400
60	300	700	1,300	2,200	3,300	1,300	3,100
80	260	610	1,200	1,900	2,900	1,200	2,600
100	220	540	1,000	1,700	2,600	1,000	2,300
125	200	490	900	1,400	2,300	900	2,100
150	190	430	830	1,300	2,100	830	1,900
175	170	400	780	1,200	1,900	770	1,700
200	160	380	730	1,100	1,800	720	1,500

To convert to capacities at 15 psig settings - multiply by 1.130
 To convert to capacities at 5 psig settings - multiply by 0.879

Sizing Between Second or Second Stage Regulator & Appliance*

Maximum Propane Capacities listed are based on 1/2" W.C. pressure drop at 11" W.C. setting. Capacities in 1,000 BTU/hour.

Pipe or Tubing Length Feet	Tubing Size, O.D. Type L					Nominal Pipe Size Schedule 40				
	3/8"	1/2"	5/8"	3/4"	7/8"	1/2"	3/4"	1"	1-1/4"	1-1/2"
10	39	92	199	329	501	275	567	1,071	2,205	3,307
20	26	62	131	216	346	189	393	732	1,496	2,299
30	21	50	107	181	277	152	315	590	1,212	1,858
40	19	41	90	145	233	129	267	504	1,039	1,559
50	18	37	79	131	198	114	237	448	913	1,417
60	16	35	72	1,211	187	103	217	409	834	1,275
80	13	29	62	104	155	89	185	346	724	1,066
100	11	26	55	90	138	78	162	307	630	976
125	10	24	48	81	122	69	146	275	567	866
150	9	21	43	72	109	63	132	252	511	787
200	8	19	39	66	100	54	112	209	439	665
250	8	17	36	60	93	48	100	185	390	590

*Data in accordance with NFPA pamphlet No. 54

Propane Gas Piping Charts

When installing a propane storage tank, the contractor must consider proper tank sizing, safety, efficiency, ground characteristics and aesthetics. For a residential customer, the size may range from 100-1,000 gallons, depending on household use. Typically, a 500 gallon tank is ample for an average four-bedroom home. However, it is best to consult your local propane supplier to ensure the proper sizing for propane storage requirements. Determining the correct tank size for each household is a function of demand, economy, efficiency and convenience. It is a process that requires co-operation between the propane supplier and customer.

ELECTRICAL CONNECTIONS



WARNING

TO AVOID THE RISK OF ELECTRICAL SHOCK, WIRING TO THE UNIT MUST BE PROPERLY POLARIZED AND GROUNDED.



WARNING

HIGH VOLTAGE
 DISCONNECT ALL POWER BEFORE SERVICING OR CHANGING ANY ELECTRICAL WIRING. MULTIPLE POWER SOURCES MAY BE PRESENT. FAILURE TO DO SO MAY CAUSE PROPERTY DAMAGE, PERSONAL INJURY OR DEATH.



CAUTION

LABEL ALL WIRES PRIOR TO DISCONNECTION WHEN SERVICING CONTROLS. WIRING ERRORS CAN CAUSE IMPROPER AND DANGEROUS OPERATION. VERIFY PROPER OPERATION AFTER SERVICING.

WIRING HARNESS

The wiring harness is an integral part of this furnace. Field alteration to comply with electrical codes should not be required. Wires are color coded for identification purposes. Refer to the wiring diagram for wire routings. If any of the

SYSTEM OPERATION

original wire as supplied with the furnace must be replaced, it must be replaced with wiring material having a temperature rating of at least 105° C. Any replacement wiring must be copper conductor.

CIRCULATING AIR AND FILTERS DUCTWORK - AIR FLOW

Duct systems and register sizes must be properly designed for the C.F.M. and external static pressure rating of the furnace. Ductwork should be designed in accordance with the recommended methods of "Air Conditioning Contractors of America" manual D.

A duct system should be installed in accordance with Standards of the National Board of Fire Underwriters for the Installation of Air Conditioning, Warm Air Heating and Ventilating Systems, Pamphlets No. 90A and 90B.

A return air filter is not supplied with the furnace. The installer must supply a means of filtering all of the return air. Filter(s) shall comply with UL900 or CAN/ULC-S111 Standards.

Upflow / Horizontal Models	Minimum Recommended Filter Size [^]
0403A	1 - 16 X 25 Side or 1 - 14 X 24 Bottom Return
0603A	1 - 16 X 25 Side or 1 - 14 X 24 Bottom Return
0604B	1 - 16 X 25 Side or Bottom Return
0803B	1 - 16 X 25 Side or Bottom Return
0804B	1 - 16 X 25 Side or Bottom Return
0805C	1 - 16 X 25 Side or Bottom Return ¹
0805D	2 - 16 X 25 Side or 1 - 20 X 25 Bottom Return
1005C	2 - 16 X 25 Side or 1 - 20 X 25 Bottom Return
1205D	2 - 16 X 25 Side or 1 - 24 X 24 Bottom Return

Downflow Models	Minimum Recommended Filter Size [^]
0403A	2 - 10 X 20 or 1 - 14 X 25 Top Return
0603A	2 - 10 X 20 or 1 - 14 X 25 Top Return
0804B	2 - 14 X 20 or 1 - 16 X 25 Top Return
1005C	2 - 14 X 20 or 1 - 20 X 25 Top Return

[^] Other size filters of equal or greater dimensions may be used, filters may also be centrally located

¹ = use 2 - 16 X 25 filters and two side returns or 20 X 25 filter on bottom return if furnace is connected to a cooling unit over 4 tons nominal capacity

Upflow furnaces with air delivery of less than 1800 CFM:
Use one side return or one bottom return ductwork connection.

Upflow furnaces with air delivery of 1800 CFM or higher:
Use two side returns or bottom return connection.

Guide dimples locate the side and bottom return cutout locations. Use a straight edge to scribe lines connecting the dimples. Cut out the opening on these lines. An undersized opening will cause reduced airflow. For bottom return connection, remove the bottom of the cabinet before setting the furnace on the raised platform or return air duct.

A closed return duct system must be used, with the return duct connected to the furnace. **NOTE: Ductwork must never be attached to the back of the furnace.** Supply and return connections to the furnace may be made with flexible joints to reduce noise transmission, if desired. If a central return is used, a connecting duct must be installed between the unit and the utility room wall so the blower will not interfere with combustion air or draft. The room, closet, or alcove must not be used as a return air chamber.

When the furnace is used in connection with a cooling unit, the furnace should be installed in parallel with or on the upstream side of the cooling unit to avoid condensation in the heating element. With a parallel flow arrangement, the dampers or other means used to control the flow of air must be adequate to prevent chilled air from entering the furnace and, if manually operated, must be equipped with means to prevent operation of either unit unless the damper is in the full heat or cool position.

When the furnace is heating, the temperature of the return air entering the furnace must be between **55°F** and **100°F**.

UPRIGHT FILTER INSTALLATIONS

Depending on the installation and/or customer preference, differing filter arrangements can be applied. Filters can be installed in the central return register and a side panel external filter rack kit (upflow filter kit # EFR01). As an alternative a media air filter or electronic air cleaner can be used as the requested filter. Refer to the following minimum filter requirement charts for determination of the minimum filter area to ensure proper unit performance.

COUNTERFLOW FILTER INSTALLATION

This furnace has provisions for the installation of return air filters at the counterflow top return. Refer to Minimum Filter Area tables to determine filter area requirement.

NOTE: Filters can also be installed elsewhere in the duct system such as a central return.

HORIZONTAL INSTALLATIONS



Filter(s) must be installed external to the furnace casing for horizontal installations. For most installations it is preferable to use a central return with filters installed in the duct behind the return air grille. In this way filter replacement is relatively simple by merely removing the grille, rather than going into the attic or crawl space.

ADDITIONAL FILTERING ACCESSORIES

EXTERNAL FILTER RACK KIT (EFR01)

The external filter rack kit is intended to provide a location external to the furnace casing, for installation of a permanent filter on upflow model furnaces. The rack is designed to mount over the indoor blower compartment area of either side panel, and provide filter retention as well as a location for attaching return air ductwork.

SCHEDULED MAINTENANCE

 WARNING	
HIGH VOLTAGE DISCONNECT ALL POWER BEFORE SERVICING OR CHANGING ANY ELECTRICAL WIRING. MULTIPLE POWER SOURCES MAY BE PRESENT. FAILURE TO DO SO MAY CAUSE PROPERTY DAMAGE, PERSONAL INJURY OR DEATH.	

 CAUTION	
IF YOU MUST HANDLE THE IGNITOR, HANDLE WITH CARE. TOUCHING THE IGNITOR BODY WITH BARE FINGERS, ROUGH HANDLING, OR VIBRATION COULD RESULT IN EARLY IGNITOR FAILURE. ONLY A QUALIFIED SERVICER SHOULD EVER HANDLE THE IGNITOR.	

ANNUAL INSPECTION

The furnace should be inspected by a qualified installer, or service agency at least once per year. This check should be performed at the beginning of the heating season. This will ensure that all furnace components are in proper working order and that the heating system functions appropriately. Pay particular attention to the following items. Repair or service as necessary.



- Flue pipe system. Check for blockage and/or leakage. Check the outside termination and the connections at and internal to the furnace.
- Combustion air intake pipe system (where applicable). Check for blockage and/or leakage. Check the outside termination and the connection at the furnace.
- Heat exchanger. Check for corrosion and/or buildup within the heat exchanger passageways.
- Burners. Check for proper ignition, burner flame, and flame sense.
- Drainage system. Check for blockage and/or leakage. Check hose connections at and internal to furnace.
- Wiring. Check electrical connections for tightness and/or corrosion. Check wires for damage.
- Filters.

AIR FILTER

 WARNING
NEVER OPERATION FURNACE WITHOUT A FILTER INSTALLED AS DUST AND LINT WILL BUILD UP ON INTERNAL PARTS RESULTING IN LOSS OF EFFICIENCY, EQUIPMENT DAMAGE, AND POSSIBLE FIRE.

Filters must be used with this furnace. Filters do not ship with these furnaces but must be provided by the installer for proper furnace operation.

Remember that dirty filters are the most common cause of inadequate heating or cooling performance.

 WARNING	
HIGH VOLTAGE DISCONNECT ALL POWER BEFORE SERVICING, REMOVING THE FILTER OR PERFORMING ANY MAINTENANCE. MULTIPLE POWER SOURCES MAY BE PRESENT. FAILURE TO DO SO MAY CAUSE PROPERTY DAMAGE, PERSONAL INJURY OR DEATH.	

MAINTENANCE

Improper filter maintenance is the most common cause of inadequate heating or cooling performance. Filters should be cleaned (permanent) or replaced (disposable) every two months or as required. It is the owner's responsibility to keep air filters clean. When replacing a filter, it must be replaced with a filter of the same type and size.

FILTER REMOVAL

Depending on the installation, differing filter arrangements can be applied. Filters can be installed in the central return register, the bottom of the blower compartment (upflow only), a side panel external filter rack kit (upflow only), or the ductwork above a counterflow furnace. A media air filter or electronic air cleaner can be used as an alternate filter. The filter sizes given in the *Product Design* section of this manual or the product *Specification Sheet* must be followed to ensure proper unit performance. Refer to the following information for removal and installation of filters.

FILTER REMOVAL PROCEDURE

MEDIA AIR FILTER OR ELECTRONIC AIR CLEANER REMOVAL

Follow the manufacturer's directions for service.

UPRIGHT COUNTERFLOW FILTER REMOVAL

To remove filters from the ductwork above an upright counterflow installation:

1. Turn off electrical power to furnace.
2. Remove access door in ductwork above furnace.
3. Remove filters.
4. Remove blower compartment door. Vacuum compartment. Replace blower compartment door.
5. Replace filters opposite of removal.
6. Replace access door in ductwork.

HORIZONTAL UNIT FILTER REMOVAL

Filters in horizontal installations are located in the central return register.

SCHEDULED MAINTENANCE



INDUCED DRAFT AND CIRCULATION BLOWERS

The bearings in the induced draft blower and circulator blower motors are permanently lubricated by the manufacturer. No further lubrication is required. Check motor windings for accumulation of dust which may cause overheating. Clean as necessary.

FLAME SENSOR (QUALIFIED SERVICER ONLY)

Under some conditions, the fuel or air supply can create a nearly invisible coating on the flame sensor. This coating acts as an insulator, causing a drop in the flame sensing signal. If this occurs, a qualified servicer must carefully clean the flame sensor with steel wool. After cleaning, the flame sensor output should be as listed on the specification sheet.

BURNERS

 WARNING	
<p>HIGH VOLTAGE ELECTRICAL COMPONENTS ARE CONTAINED IN BOTH COMPARTMENTS. TO AVOID ELECTRICAL SHOCK, INJURY OR DEATH, DO NOT REMOVE ANY INTERNAL COMPARTMENT COVERS OR ATTEMPT ANY ADJUSTMENT. CONTACT A QUALIFIED SERVICE AGENT AT ONCE IF AN ABNORMAL FLAME APPEARANCE SHOULD DEVELOP.</p>	

Periodically during the heating season make a visual check of the burner flames. Turn the furnace on at the thermostat. Wait a few minutes since any dislodged dust will alter the normal flame appearance. Flames should be stable, quiet, soft and blue with slightly orange tips. They should not be yellow. They should extend directly outward from the burner ports without curling downward, floating or lifting off the ports.

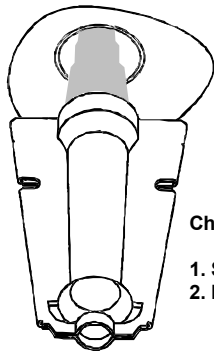

Check the burner flames for:

1. Stable, soft and blue
2. Not curling, floating, or lifting off.

Burner Flame

TEST EQUIPMENT

Proper test equipment for accurate diagnosis is as essential as regular hand tools.

The following is a must for every service technician and service shop.

1. Thermometers or thermocouple meter (optional) - To measure temperatures.
2. Multi-Meter - To measure amperage and voltage, to test continuity, capacitors, and motor windings.
3. Manometer - To measure static pressure, pressure drop across coils, filters and draft, and to measure inlet and manifold gas pressures.

Other recording type instruments can be essential in solving abnormal problems, however, in many instances they may be rented from local sources.

Proper equipment promotes faster, more efficient service and accurate repairs resulting in fewer call backs.

HEATING PERFORMANCE TEST

Before attempting to diagnose an operating fault code, run a Heating Performance Test to determine if the heating system is performing within 5% of the BTU input found on the rating plate of the unit being tested. To conduct a heating performance test, the BTU input to the unit must be calculated (see Clocking a Gas Meter). Before clocking a gas meter, contact your local utility to provide the caloric value (BTU content) of the natural gas in the area.

It is also important to confirm the airflow (CFM) is within the temperature rise range (see Airflow Data in spec sheet) and external static pressure range (approximately 0.5" water column). How-to instructions can be found in the service manual under Checking External Static Pressure and Checking Temperature Rise.

SCHEDULED MAINTENANCE

CLOCKING A GAS METER

1. Turn off all gas appliances in the home.
2. Turn on the furnace. Ensure the furnace is operating at a 100% firing rate on 2 stage and modulating furnace product.
3. Once heating cycle is at a steady state (typically 15 minutes of operation), use a stopwatch to time how long it takes the smallest unit of measure dial on the gas meter to make a full revolution. In Table 1, one cubic foot is selected. The smallest unit of measure will vary depending on the gas meter.

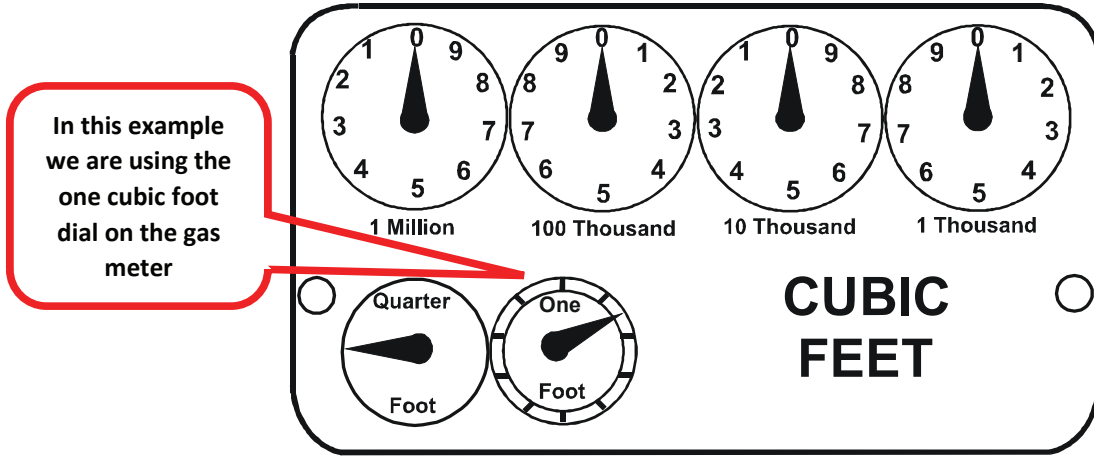

TABLE 1

4. Using Table 2 below, find the number of seconds it took for the dial to make a full revolution. To the right of that number of seconds and below the Size of Test Dial (selected in step 3 and shown in Table 1) will be the Cubic Feet per Hour (CFH).

Locate 40 seconds for one revolution in the chart below

Then locate the 1 cu ft dial column and select the corresponding CFH from the 40 seconds for one revolution row

GAS RATE -- CUBIC FEET PER HOUR											
Seconds for One Revolution	Size of Test Dial					Seconds for One Revolution	Size of Test Dial				
	1/4 cu/ft	1/2 cu/ft	1 cu/ft	2 cu/ft	5 cu/ft		1/4 cu/ft	1/2 cu/ft	1 cu/ft	2 cu/ft	5 cu/ft
10	90	180	360	720	1800	36	25	50	100	200	500
11	82	164	327	655	1636	37	--	--	97	195	486
12	75	150	300	600	1500	38	23	47	95	189	474
13	69	138	277	555	1385	39	--	--	92	185	462
14	64	129	257	514	1286	40	22	45	90	180	450
15	60	120	240	480	1200	41	--	--	--	176	439
16	56	113	225	450	1125	42	21	43	86	172	429
17	53	106	212	424	1059	43	--	--	--	167	419
18	50	100	200	400	1000	44	--	41	82	164	409
19	47	95	189	379	947	45	20	40	80	160	400
20	45	90	180	360	900	46	--	--	78	157	391
21	43	86	171	343	857	47	19	38	76	153	383
22	41	82	164	327	818	48	--	--	75	150	375
23	39	78	157	313	783	49	--	--	--	147	367
24	37	75	150	300	750	50	18	36	72	144	360
25	36	72	144	288	720	51	--	--	--	141	355
26	34	69	138	277	692	52	--	--	69	138	346
27	33	67	133	265	667	53	17	34	--	136	340
28	32	64	129	257	643	54	--	--	67	133	333
29	31	62	124	248	621	55	--	--	--	131	327
30	30	60	120	240	600	56	16	32	64	129	321
31	--	--	116	232	581	57	--	--	--	126	316
32	28	56	113	225	563	58	--	31	62	124	310
33	--	--	109	218	545	59	--	--	--	122	305
34	26	53	106	212	529	60	15	30	60	120	300
35	--	--	103	206	514	--	--	--	--	--	--

TABLE 2

SCHEDULED MAINTENANCE

5. Use this formula to verify the Cubic Feet per Hour (CFH) input determined in step 4 is correct:

$$(3600 \times \text{Gas Meter Dial Size}) / \text{Time (seconds)} = \text{Cubic Feet per Hour (CFH)}$$

3600 is used as there are 60 seconds in a minute and 60 minutes in an hour.
60x60=3600

6. Check with your local utility for actual BTU content (caloric value) of natural gas in the area (the average is 1025 BTU's).

7. Use this formula to calculate the BTU/HR input (See BTU/HR Calculation Example):

$$\text{Cubic Feet per Hour (CFH)} \times \text{BTU content of your natural gas} = \text{BTU/HR input}$$

8. Should the figure you calculated not fall within five (5) percent of the nameplate rating of the unit, adjust the gas valve pressure regulator or resize orifices. To adjust the pressure regulator on the gas valve, turn downward (clockwise) to increase pressure and input, and upward (counterclockwise) to decrease pressure and input. A properly operating unit must have the BTU per hour input and CFM of air, within the limits shown to prevent short cycling of the equipment. As the external static pressure goes up, the temperature rise will also increase. Consult the proper tables for temperature rise limitation.

BTU/HR Calculation Example:

The unit being tested takes 40 seconds for the 1 cubic foot dial to make one complete revolution. Using the chart, this translates to 90 cubic feet per hour. Based upon the assumption that one cubic foot of natural gas has 1,025 BTU's (Check with your local utility for actual BTU content), the **calculated input is 92,250 BTU's per hour.**

Furnace Nameplate Input in this example: 90,000 BTU/HR

Calculated Gas Input in this example: 92,250 BTU/HR

This example is within the 5% tolerance input and does not need adjustment.

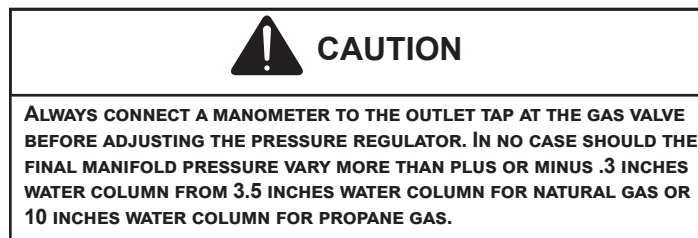

To adjust the pressure regulator on the gas valve, turn down (clockwise) to increase pressure and input, and out (counterclockwise) to decrease pressure and input.

Since normally propane gas is not installed with a gas meter, clocking will be virtually impossible. The gas orifices used with propane are calculated for 2500 BTU per cubic foot gas and with proper inlet pressures and correct piping size, full capacity will be obtained.

With propane gas, no unit gas valve regulator is used; however, the second stage supply line pressure regulator should be adjusted to give 11" water column with all other gas consuming appliances running.

The dissipation of the heat transferred to the heat exchanger is now controlled by the amount of air circulated over its surface.

The amount (CFM) of air circulated is governed by the external static pressure in inches of water column of duct work, cooling coil, registers, etc., applied externally to the unit versus the motor speed tap (direct drive) or pulley adjustments of the motor and blower (belt drive).

A properly operating unit must have the BTU per hour input and CFM of air, within the limits shown to prevent short cycling of the equipment. As the external static pressure goes up, the temperature rise will also increase. Consult the proper tables for temperature rise limitation.

SERVICING

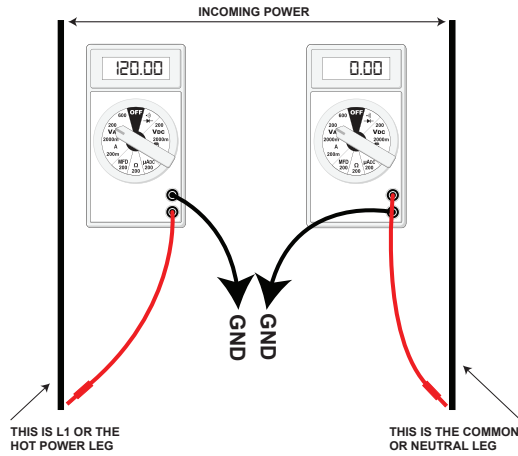

These then should be wired to the furnace accordingly.

CHECKING FOR PHASING - PRIMARY TO SECONDARY OF UNMARKED TRANSFORMERS*

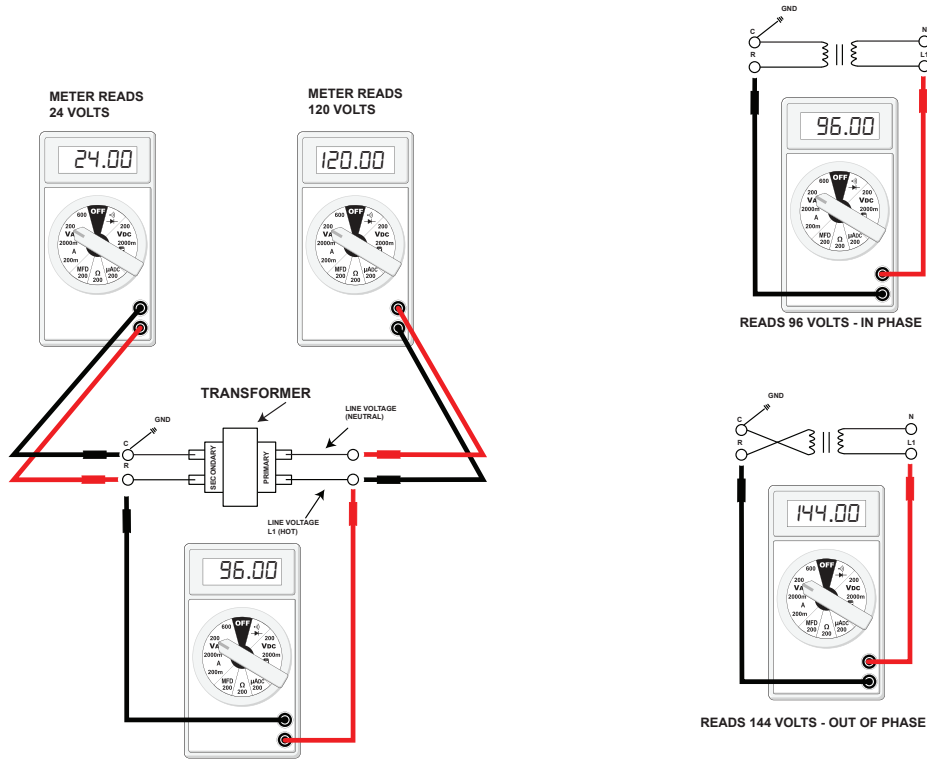

If meter reads approximately 96 volts - the primary to secondary are in phase - if reads approximately 144 volts out of phase - reverse low voltage wires.

***NOTE:** For flame rectification the common side of the secondary voltage (24 V) is cabinet grounded. If you were to bench test a transformer the primary neutral and secondary common must be connected together for testing purposes.

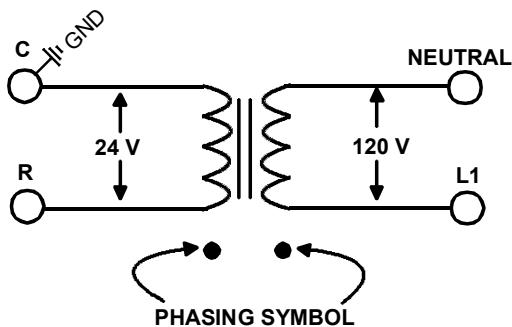

Some transformers will display phasing symbols as shown in the illustration to the left to assist in determining proper transformer phasing.

Checking for polarization and phasing should become a habit in servicing. Let's start now.

SERVICING

CHECKING VOLTAGE



WARNING

HIGH VOLTAGE

DISCONNECT ALL POWER BEFORE SERVICING OR CHANGING ANY ELECTRICAL WIRING. MULTIPLE POWER SOURCES MAY BE PRESENT. FAILURE TO DO SO MAY CAUSE PROPERTY DAMAGE, PERSONAL INJURY OR DEATH.



1. Remove the burner door to gain entry to the Junction Box.
2. Remove cover from the Junction Box and gain access to incoming power lines.

With Power ON:



WARNING

LINE VOLTAGE NOW PRESENT.

3. Using a voltmeter, measure the voltage across the hot and neutral connections.

NOTE: To energize the furnace, the Door Interlock Switch must be engaged at this point.

4. No reading - indicates open wiring, open fuse, no power, or faulty Door Interlock Switch from unit to fused disconnect service. Repair as needed.
5. With ample voltage at line voltage connectors, energize the furnace blower motor by jumpering terminals R to G on the integrated ignition control.
6. With the blower motor in operation, the voltage should be 115 volts \pm 10 percent.
7. If the reading falls below the minimum voltage, check the line wire size. Long runs of undersized wire can cause low voltage. If wire size is adequate, notify the local power company of the condition.
8. After completing check and/or repair, replace Junction Box cover and reinstall the service panel doors.
9. Turn on electrical power and verify proper unit operation.

CHECKING WIRING



WARNING

DISCONNECT ALL POWER BEFORE SERVICING.

1. Check wiring visually for signs of overheating, damaged insulation and loose connections.
2. Use an ohmmeter to check continuity of any suspected open wires.
3. If any wires must be replaced, replace with AWM, 105°C. 2/64 thick insulation of the same gauge or its equivalent.

CHECKING THERMOSTAT, WIRING



WARNING

DISCONNECT ALL POWER BEFORE SERVICING.

1. Remove the blower compartment door to gain access to the thermostat low voltage wires located at the furnace integrated control module terminals.
2. Remove the thermostat low voltage wires at the furnace control panel terminal board.
3. Jumper terminals R to W on the integrated ignition control.

With Power On (and Door Interlock Switch closed):



WARNING

LINE VOLTAGE NOW PRESENT.

4. Induced Draft Motor must run and pull in pressure switch.
5. If the hot surface ignitor heats and at the end of the ignitor warm-up period the gas valve opens and the burners ignite, the trouble is in the thermostat or wiring.
6. With power off, check the continuity of the thermostat and wiring. Repair or replace as necessary. If checking the furnace in the air conditioning mode, proceed as follows.
7. With power off, Jumper terminals R to Y to G.
8. Turn on the power.
9. If the furnace blower motor starts and the condensing unit runs, then the trouble is in the thermostat or wiring. Repair or replace as necessary.
10. After completing check and/or repair of wiring and check and/or replacement of thermostat, reinstall blower compartment door.
11. Turn on electrical power and verify proper unit operation.

CHECKING TRANSFORMER AND CONTROL CIRCUIT

As more and more electronics are introduced to the Heating Trade, Polarization of incoming power and phasing of primary to secondary voltage on transformers becomes more important.

Polarization has been apparent in the Appliance industry since the introduction of the three prong plug, however, the Heating Industry does not use a plug for incoming power, but is hard wired.

SERVICING

Some of the electronic boards being used today, with flame rectification, will not function properly and/or at all without polarization of incoming power. Some also require phasing between the primary and secondary sides of step-down transformers.

A step-down transformer 120 volt primary to 24 volt secondary, 40 VA (Heating and Cooling Models) supplies ample capacity of power for either operation.

 WARNING	
HIGH VOLTAGE DISCONNECT ALL POWER BEFORE SERVICING OR CHANGING ANY ELECTRICAL WIRING. MULTIPLE POWER SOURCES MAY BE PRESENT. FAILURE TO DO SO MAY CAUSE PROPERTY DAMAGE, PERSONAL INJURY OR DEATH.	

1. Remove blower compartment door to gain access to the thermostat low voltage wires located at the furnace integrated control module.
2. Remove the thermostat low voltage wires at the furnace integrated control module terminals.

With Power On (and Door Interlock Switch closed):

 WARNING	
LINE VOLTAGE NOW PRESENT.	

 WARNING	
DO NOT BYPASS ANY SAFETY CIRCUIT.	

3. Use a voltmeter, check voltage across terminals R and C. Must read 24 VAC.
4. No voltage indicates faulty transformer, open fuse, bad wiring, bad splice, or open door interlock switch.
5. Check transformer primary voltage at incoming line voltage connections, fuse, splices, and blower door interlock switch.
6. If line voltage is available to the primary side of transformer and not at secondary side, the transformer is inoperative. Replace.
7. After completing check and/or replacement of transformer and check and/or repair of control circuit, reinstall blower compartment door.
8. Turn on electrical power and verify proper unit operation.

CHECKING AIR CIRCULATOR BLOWER MOTOR

 WARNING	
DISCONNECT ALL POWER BEFORE SERVICING.	

1. Remove blower compartment door to gain access to the circulator blower motor and integrated ignition control.
2. Check for any obstruction that would keep the fan wheel/fan motor from turning.
3. Check wiring, the motor has two wiring harnesses, a main harness and a control harness. The main pin harness has: White neutral wire connected to the Neutral terminal on the control board. Black wire connected to the CIRC H terminal on the control board. Red wire connected to the COM terminal, which is a female spade connection next to the T1 – T5 wires on the control board.
Green ground wire connected to cabinet ground.
The control harness has:
Blue wire connected to T1 on the control board.
Red wire connected to T2 on the control board.
Orange wire connected to T3 on the control board.
Black wire connected to T4 on the control board.
Yellow wire connected to T5 on control board.
4. The multi-speed ECM motor requires a line voltage power supply (black connected to CIRC H and white connected to neutral on the control board) as well as a signal on one of the speed taps (T1-T5).
5. The speed tap voltage is A.C. and can vary which tap is energized depending on DIP switch selection. The voltage reading from any one of the speed taps is referenced between the female COM terminal next to the speed taps on the control board. From COM to T1 or T2, T3, T4, T5 you should read 24 VAC on the low voltage speed taps.

SERVICING

Motor Tap Identification		
CONNECTOR ID	DESCRIPTION	CONNECTOR VOLTAGE
L	LINE, L1	LINE, L1
G	GROUND	CHASSIS GROUND
N	LINE, L2	LINE, L2
C	SIGNAL COMMON	24VAC COMMON
1	TAP 1	24VAC
2	TAP 2	24VAC
3	TAP 3	24VAC
4	TAP 4	24VAC
5	TAP 5	24VAC



WARNING

DISCONNECT ALL POWER BEFORE SERVICING.

CHECKING DUCT STATIC

The maximum and minimum allowable external static pressures are found in the specification section. These tables also show the amount of air being delivered at a given static by a given motor speed or pulley adjustment.

The furnace motor cannot deliver proper air quantities (CFM) against statics other than those listed.

Too great of an external static pressure will result in insufficient air that can cause excessive temperature rise, resulting in limit tripping, etc. Whereas not enough static may result in motor overloading.

To determine proper air movement, proceed as follows:

1. With clean filters in the furnace, use a manometer to measure the static pressure of the return duct at the inlet of the furnace. (Negative Pressure)
2. Measure the static pressure of the supply duct. (Positive Pressure)
3. Add the two (2) readings together for total external static pressure.

NOTE: Both readings may be taken simultaneously and read directly on the manometer if so desired. If an air conditioner coil or Electronic Air Cleaner is used in conjunction with the furnace, the readings must also include these components, as shown in the following drawing.

4. Consult proper tables for the quantity of air.

If the total external static pressure exceeds the minimum or maximum allowable statics, check for closed dampers, registers, undersized and/or oversized poorly laid out duct work.

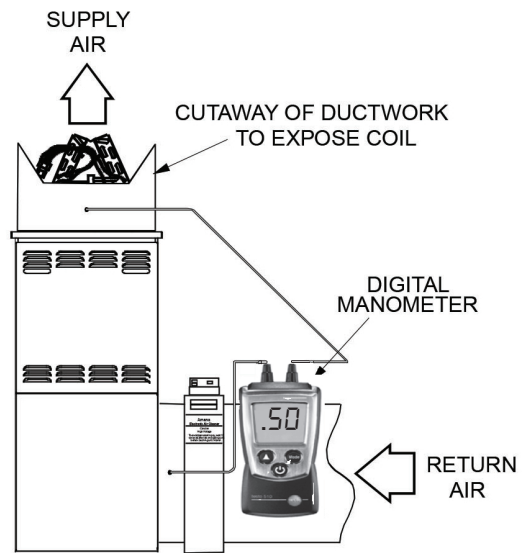

Checking Static Pressure
(80% Furnace Shown, 90% Similar)

CHECKING TEMPERATURE RISE

The more air (CFM) being delivered through a given furnace, the less the rise will be; so the less air (CFM) being delivered, the greater the rise. The temperature rise should be adjusted in accordance to a given furnace specifications and its external static pressure. An incorrect temperature rise may result in condensing in or overheating of the heat exchanger. An airflow and temperature rise table is provided in the blower performance specification section. Determine and adjust temperature rise as follows:

1. Operate furnace with burners firing for approximately ten minutes. Check BTU input to furnace - do not exceed input rating stamped on rating plate. Ensure all registers are open and all duct dampers are in their final (fully or partially open) position.
2. Place thermometers in the return and supply ducts as close to the furnace as possible. Thermometers must not be influenced by radiant heat by being able to "see" the heat exchanger.

CROSS-HATCHED AREA SUBJECTED TO RADIANT HEAT. DO NOT MEASURE SUPPLY AIR TEMPERATURE IN THIS AREA.

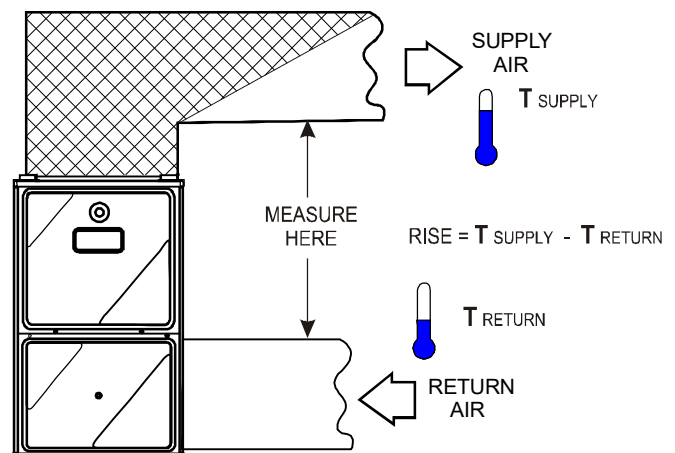

Checking Temperature Rise

SERVICING

3. Subtract the return air temperature from the supply air temperature to determine the air temperature rise. Allow adequate time for thermometer readings to stabilize.
4. Adjust temperature rise by adjusting the circulator blower speed. Increase blower speed to reduce temperature rise. Decrease blower speed to increase temperature rise. Refer to *Circulator Blower Speed* section in the Product Design section of this manual for speed changing details. Temperature rise is related to the BTUH output of the furnace and the amount of air (CFM) circulated over the heat exchanger. Measure motor current draw to determine that the motor is not overloaded during adjustments.

CHECKING PRIMARY LIMIT CONTROL

All use a nonadjustable, automatic reset, bi-metal type limit control. Refer to the following drawing for the location of the primary limit.

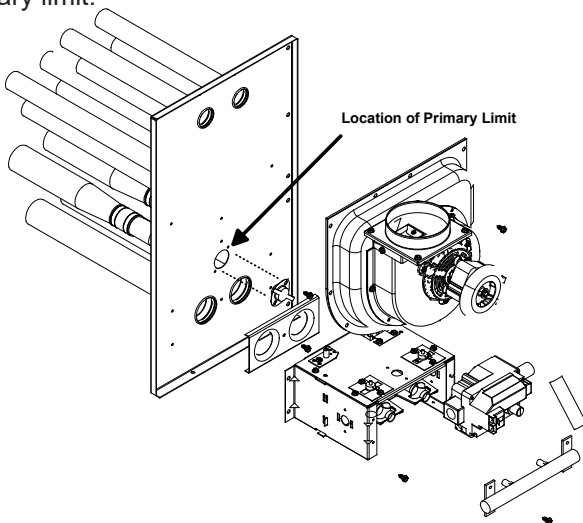

Primary Limit Control Location
(80% Upflow Furnace Shown, Counterflow Similar)

Style 1 drawing illustrates the Primary Limit used on the 80% furnaces.

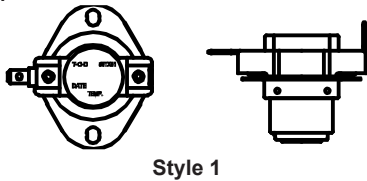

Style 1

1. Remove burner compartment door to gain access to the primary limit.
2. Remove low voltage wires at limit control terminals.
3. With an ohmmeter, test between these two terminals as shown in the following drawing. The ohmmeter should read continuous unless heat exchanger temperature is above limit control setting. If not as above, replace the control.

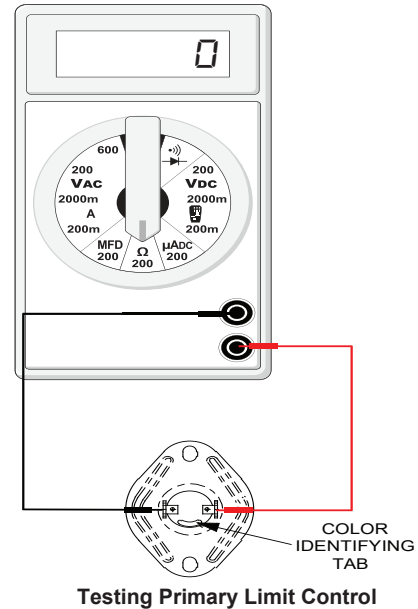

Testing Primary Limit Control



WARNING

DO NOT BYPASS ANY SAFETY LIMIT CONNECTION.

CHECKING AUXILIARY LIMIT CONTROL

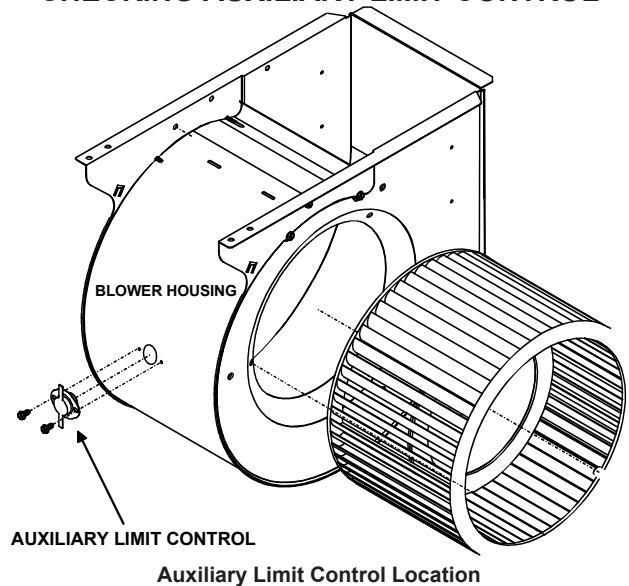

Auxiliary Limit Control Location



WARNING

HIGH VOLTAGE
DISCONNECT ALL POWER BEFORE SERVICING OR CHANGING ANY ELECTRICAL WIRING. MULTIPLE POWER SOURCES MAY BE PRESENT. FAILURE TO DO SO MAY CAUSE PROPERTY DAMAGE, PERSONAL INJURY OR DEATH.



SERVICING

WARNING

HIGH VOLTAGE
DISCONNECT ALL POWER BEFORE SERVICING OR INSTALLING THIS UNIT. MULTIPLE POWER SOURCES MAY BE PRESENT. FAILURE TO DO SO MAY CAUSE PROPERTY DAMAGE, PERSONAL INJURY OR DEATH.

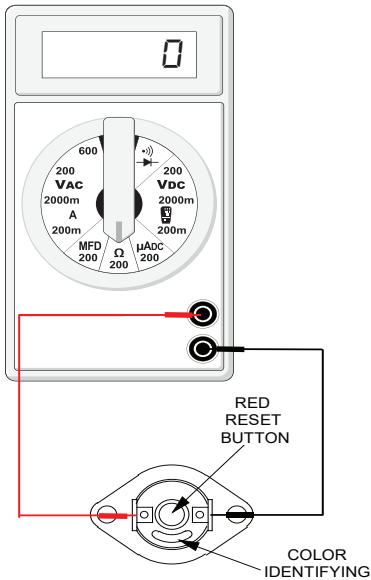

Testing Auxiliary Limit Control

WARNING

TO AVOID POSSIBLE FIRE, ONLY RESET THE AUXILIARY LIMIT CONTROL ONCE. IF IT SHOULD OPEN A SECOND TIME, A QUALIFIED SERVICER MUST DETERMINE WHY THE AUXILIARY LIMIT OPENED BEFORE RESETTING AGAIN.

CHECKING FLAME ROLLOUT CONTROL

A temperature activated manual reset control is mounted to the manifold assembly on 80% furnaces.

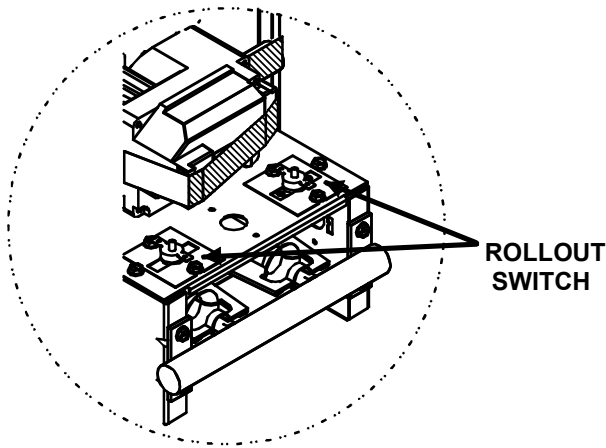

Flame Rollout Switch Location
 (80% Upflow Furnace Shown, Downflow Similar)

The control is designed to open should a flame roll out occur. An over firing condition or flame impingement on the heat shield may also cause the control to open. If the rollout control opens, the air circulation blower will run continuously.

On single-stage 80% the ignition control diagnostic light will flash (6) six times indicating a trip of the rollout switch. (On some models this also indicates an open control board fuse)

WARNING

LINE VOLTAGE NOW PRESENT.

1. Remove the burner compartment door to gain access to the rollout switch(es) mounted to burner bracket.

The servicer should reset the ignition control by opening and closing the thermostat circuit. Then look for the ignitor glowing which indicates there is power to the ignition control. Measure the voltage between each side of the rollout control and ground while the ignition control tries to power the gas valve

2. Measure the voltage between each side of the rollout control and ground during the ignition attempt. Refer to the following figure.

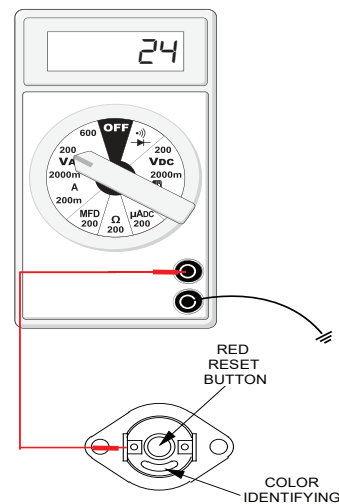

Checking Flame Rollout Switch

- a. If no voltage is measured on either side of control it indicates ignition control or wiring to control problem.
 - b. If voltage is measured on one side of the control and not the other it indicates the control is open.
 - c. If voltage is measured on both sides of the control the wiring to gas valve or valve is at fault.
3. After check and/or replacement of rollout switch, reinstall burner compartment door and verify proper unit operation.

SERVICING

INDUCED DRAFT BLOWER MOTOR



WARNING

HIGH VOLTAGE

DISCONNECT ALL POWER BEFORE SERVICING OR INSTALLING THIS UNIT. MULTIPLE POWER SOURCES MAY BE PRESENT. FAILURE TO DO SO MAY CAUSE PROPERTY DAMAGE, PERSONAL INJURY OR DEATH.



1. Remove burner compartment door to gain access to the induced draft blower motor.
2. Disconnect the motor wire leads from its connection point at the induced draft motor.
3. Using an ohmmeter, test for continuity between each of the motor leads.
4. Touch one probe of the ohmmeter to the motor frame (ground) and the other probe in turn to each lead. If the windings do not test continuous or a reading is obtained to ground, replace the motor.
5. If the windings have a continuity reading, reconnect wires. Turn power on to the furnace and turn the thermostat on in the heating mode. Check voltage for 115V at the induced draft motor terminals during the trial for ignition. If you have 115V and the motor does not run, replace the induced draft motor.
6. After completing check and/or replacement of induced draft motor, reinstall burner compartment door.
7. Turn on electrical power and verify proper unit operation.

CHECKING GAS VALVE (Redundant)

A combination redundant operator type gas valve which provides all manual and automatic control functions required for gas fired heating equipment is used.

The valve provides control of main burner gas flow, pressure regulation, and 100 percent safety shut-off.



WARNING

DISCONNECT ALL POWER BEFORE SERVICING.

Single stage gas valves should be tested on the furnace with 24 VAC connected to the gas valve and manometers reading supply line and manifold pressures.

CHECKING MAIN BURNERS

The main burners are used to provide complete combustion of various fuels in a limited space, and transfer this heat of the burning process to the heat exchanger.

Proper ignition, combustion, and extinction are primarily due to burner design, orifice sizing, gas pressure, primary and secondary air, vent and proper seating of burners.

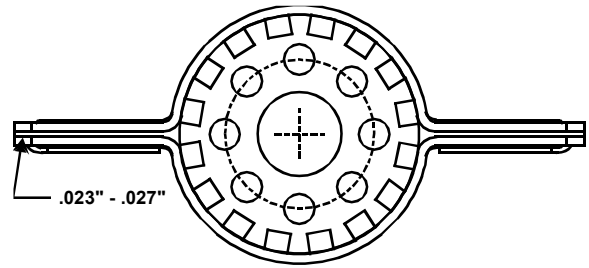

Beckett Burner



WARNING

DISCONNECT ALL GAS AND ELECTRICAL POWER SUPPLY.

In checking main burners, look for signs of rust, oversized and undersized carry over ports restricted with foreign material, etc, refer to previous drawing. Burner cross-over slots must not be altered in size.

CHECKING ORIFICES

A predetermined fixed gas orifice is used in all of these furnaces. That is an orifice which has a fixed bore and position as shown in the following drawing.

No resizing should be attempted until all factors are taken into consideration such as inlet and manifold gas pressure, alignment, and positioning, specific gravity and BTU content of the gas being consumed.

The only time resizing is required is when a reduction in firing rate is required for an increase in altitude.

Orifices should be treated with care in order to prevent damage. They should be removed and installed with a box-end wrench in order to prevent distortion. In no instance should an orifice be peened over and redrilled. This will change the angle or deflection of the vacuum effect or entraining of primary air, which will make it difficult to adjust the flame properly. This same problem can occur if an orifice spud of a different length is substituted.



WARNING

DISCONNECT ALL GAS AND ELECTRICAL POWER SUPPLY.

1. Check orifice visually for distortion and/or burrs.
2. Check orifice size with orifice sizing drills.
3. If resizing is required, a new orifice of the same physical size and angle with proper drill size opening should be installed.

SERVICING

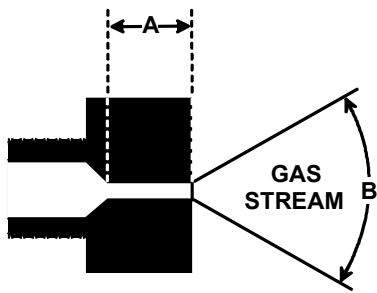

The length of Dimension "A" determines the angle of Gas Stream "B".

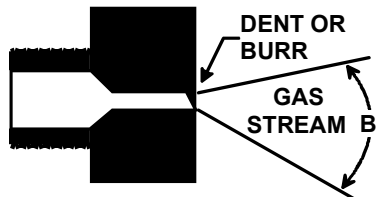

A dent or burr will cause a severe deflection of the gas stream.

CHECKING GAS PRESSURE

GAS SUPPLY PRESSURE MEASUREMENT



CAUTION

TO PREVENT UNRELIABLE OPERATION OR EQUIPMENT DAMAGE, THE INLET GAS SUPPLY PRESSURE MUST BE AS SPECIFIED ON THE UNIT RATING PLATE WITH ALL OTHER HOUSEHOLD GAS FIRED APPLIANCE OPERATING.

Gas inlet and manifold pressures should be checked and adjusted in accordance to the type of fuel being consumed. The line pressure supplied to the gas valve must be within the range specified below. The supply pressure can be measured at the gas valve inlet pressure tap or at a hose fitting installed in the gas piping drip leg. The supply pressure must be measured with the burners operating. To measure the gas supply pressure, use the following procedure.



WARNING

DISCONNECT ELECTRICAL POWER AND SHUT OFF GAS SUPPLY.

1. After turning off gas to furnace at the manual gas shutoff valve external to the furnace, remove burner compartment door to gain access to the gas valve.
2. Connect a calibrated manometer (or appropriate gas pressure gauge) at either the gas valve inlet pressure tap or the gas piping drip leg as shown in the following figures. Refer to *Measuring Gas Pressure: Single Stage Valves* figure for single stage valve inlet pressure tap connections.

NOTE: At either location, a hose fitting must be installed prior to making the hose connection.

NOTE: Use adapter kit #0151K00000S to measure gas pressure on White-Rodgers 36J22 gas valves.

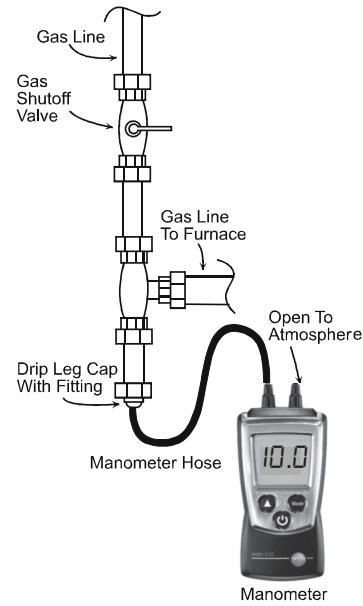

Measuring Inlet Gas Pressure (Alternate Method)

3. Turn ON the gas and electrical power supply and operate the furnace and all other gas consuming appliances on the same gas supply line.
4. Measure furnace gas supply pressure with burners firing. Supply pressure must be within the range specified in the following table.

INLET GAS SUPPLY PRESSURE		
Natural Gas	Minimum: 4.5" w.c.	Maximum: 10.0" w.c.
Propane Gas	Minimum: 11.0" w.c.	Maximum: 13.0" w.c.

If supply pressure differs from above, make necessary adjustments to pressure regulator, gas piping size, etc., and/or consult with local gas utility.



WARNING

HIGH VOLTAGE
DISCONNECT ALL ELECTRICAL POWER AND SHUT OFF GAS SUPPLY BEFORE SERVICING OR INSTALLING THIS UNIT. MULTIPLE POWER SOURCES MAY BE PRESENT. FAILURE TO DO SO MAY CAUSE PROPERTY DAMAGE, PERSONAL INJURY OR DEATH.



5. Disconnect manometer after turning off gas at manual shutoff valve. Reinstall plug before turning on gas to furnace.
6. Turn OFF any unnecessary gas appliances started in step 3.
7. Turn on gas to furnace and check for leaks. If leaks are found, repair and then reinstall burner compartment door.
8. Turn on electrical power and verify proper unit operation.

SERVICING

GAS MANIFOLD PRESSURE MEASUREMENT AND ADJUSTMENT



CAUTION

TO PREVENT UNRELIABLE OPERATION OR EQUIPMENT DAMAGE, THE GAS MANIFOLD PRESSURE MUST BE AS SPECIFIED ON THE UNIT RATING PLATE. ONLY MINOR ADJUSTMENTS SHOULD BE MADE BY ADJUSTING THE GAS VALVE PRESSURE REGULATOR.

NOTE: Use adapter kit #0151K00000S to measure gas pressure on White-Rodgers 36J22 gas valves.

Only small variations in gas pressure should be made by adjusting the gas valve pressure regulator. The manifold pressure must be measured with the burners operating. To measure and adjust the manifold pressure, use the following procedure.



WARNING

HIGH VOLTAGE
DISCONNECT ALL ELECTRICAL POWER AND SHUT OFF GAS SUPPLY BEFORE SERVICING OR INSTALLING.

1. After turning off gas to furnace at the manual gas shut-off valve external to the furnace, remove burner compartment door to gain access to the gas valve.
2. Connect a calibrated manometer (or appropriate gas pressure gauge) at the gas valve outlet pressure tap. Refer to *Measuring Gas Pressure: Single Stage Valves* figure for single stage valve outlet pressure tap connections.



WARNING

LINE VOLTAGE NOW PRESENT.

3. Turn ON the gas and electrical power supply and operate the furnace.
4. Measure gas manifold pressure with burners firing. Adjust manifold pressure using the table below.

Manifold Gas Pressure	
Natural Gas	3.5" w.c.
Propane Gas	10.0" w.c.

The final manifold pressure must not vary more than ± 0.3 " w.c. from the above specified pressures. Any necessary major changes in gas flow rate should be made by changing the size of the burner orifice.

5. White-Rodgers 36G22 Valves:
 - a. Back outlet pressure test screw (inlet/outlet pressure boss) out one turn (counterclockwise, not more than one turn).
 - b. Attach a hose and manometer to the outlet pressure outlet pressure boss.
 - c. Turn ON the gas supply.
 - d. Turn on power and close thermostat "R" and "W1" contacts to provide a call for low stage heat.

- e. Measure the gas manifold pressure with burners firing. Adjust manifold pressure using the *Manifold Gas Pressure* table shown below.
 - f. Remove regulator cover screw from the outlet pressure regulator adjust tower and turn screw clockwise to increase pressure or counterclockwise to decrease pressure. Replace regulator cover screw.
 - g. Turn off all electrical power and gas supply to the system.
 - h. Remove the manometer hose from the hose barb fitting or outlet pressure boss.
 - i. Turn outlet pressure test screw in to seal pressure port (clockwise, 7 in-lb minimum).
6. Honeywell VR8215 Valve
 - a. Remove the outlet pressure boss plug. Install an 1/8" NPT hose barb fitting into the outlet pressure tap.
 - b. Attach a hose and manometer to the outlet pressure barb fitting.
 - c. Turn ON the gas supply.
 - d. Turn on power and close thermostat "R" and "W1" contacts to provide a call for low stage heat.
 - e. Measure the gas manifold pressure with burners firing. Adjust manifold pressure using the *Manifold Gas Pressure* table shown below.
 - f. Remove regulator cover screw from the outlet pressure regulator adjust tower and turn screw clockwise to increase pressure or counterclockwise to decrease pressure. Replace regulator cover screw.
 - g. Turn off all electrical power and gas supply to the system.
 - h. Remove the manometer hose from the hose barb fitting or outlet pressure boss.
 - i. Remove the 1/8" NPT hose barb fitting from the outlet pressure tap. Replace the outlet pressure boss plug and seal with a high quality thread sealer.



WARNING

HIGH VOLTAGE
DISCONNECT ALL ELECTRICAL POWER AND SHUT OFF GAS SUPPLY BEFORE SERVICING OR INSTALLING THIS UNIT. MULTIPLE POWER SOURCES MAY BE PRESENT. FAILURE TO DO SO MAY CAUSE PROPERTY DAMAGE, PERSONAL INJURY OR DEATH.



7. Turn on gas to furnace and check for leaks. If leaks are found, repair and then reinstall burner compartment door.
8. Turn on electrical power and verify proper unit operation.

SERVICING

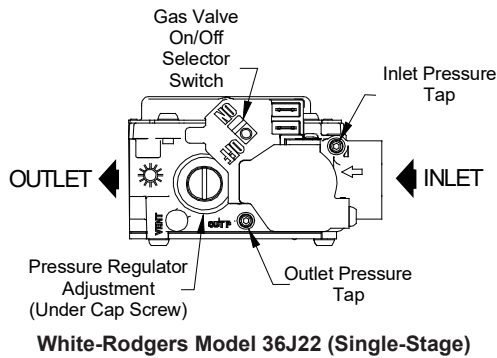

WARNING

LINE VOLTAGE NOW PRESENT.

6. After checking and/or replacing of hot surface ignitor, reinstall burner compartment door and verify proper unit operation.

CHECKING FOR FLASHBACK

Flashback will also cause burning in the burner venturi, but is caused by the burning speed being greater than the gas-air flow velocity coming from a burner port.

Flashback may occur at the moment of ignition, after a burner heats up or when the burner turns off. The latter is known as extinction pop.

Since the end results of flashback and delayed ignition can be the same (burning in the burner venturi) a definite attempt should be made to determine which has occurred.

If flashback should occur, check for the following:

1. Improper gas pressure - Adjust to proper pressure (See *CHECKING GAS PRESSURE*).
2. Check burner for proper alignment and/or replace burner.
3. Improper orifice size - Check orifice for obstruction.

CHECKING PRESSURE SWITCH

The pressure switch is a safety device to prevent the combustion cycle from occurring with inadequate venting caused by a restricted or blocked vent pipe on the 80% and 90% furnaces.

WARNING

HIGH VOLTAGE
DISCONNECT ALL POWER BEFORE SERVICING OR INSTALLING THIS UNIT. MULTIPLE POWER SOURCES MAY BE PRESENT. FAILURE TO DO SO MAY CAUSE PROPERTY DAMAGE, PERSONAL INJURY OR DEATH.

1. Remove burner compartment door to gain access to pressure switch(es).
2. Remove wires from the pressure switch(es) electrical terminals.
3. Using a VOM check from common terminal to NC (Normally Closed) - should read open.

If switch reads as above proceed to Step 4, otherwise replace control.

4. Remove the pressure control hose from the control and interconnect with a manometer as shown in the following figures.

WARNING

HIGH VOLTAGE
DISCONNECT ALL ELECTRICAL POWER AND SHUT OFF GAS SUPPLY BEFORE SERVICING OR INSTALLING.

Manifold Gas Pressure			
Gas	Rate	Range	Nominal
Propane Gas	High Stage	9.7 to 10.3" w.c.	10.0" w.c.

CHECKING HOT SURFACE IGNITOR

120V Mini Ignitor Single Stage - Furnaces use a 120V carbide mini igniter for ignition (part# 20165703) or a Silicon Nitride igniter (part# 0130F00008). The normal operating temperature is approximately 2550°F - 2876°F.

WARNING

DISCONNECT ALL POWER BEFORE SERVICING.

1. Remove burner compartment door to gain access to the ignitor.
2. Ignitor cool - approximately 70 - 77°F.
3. Disconnect the ignitor from the Ignition Control.
4. Using an ohmmeter measure the resistance of the ignitor:
Mini Igniter: Carbide Mini Igniter should read between 30 to 300 ohms.
5. Reconnect ignitor.

120V Silicon Nitride Ignitor - Furnaces with a 120V silicone nitride igniter. The normal operating temperature is approximately 2156°F - 2678°F. At room temperature the ignitor ohm reading should be from 37 - 68 ohms.

SERVICING

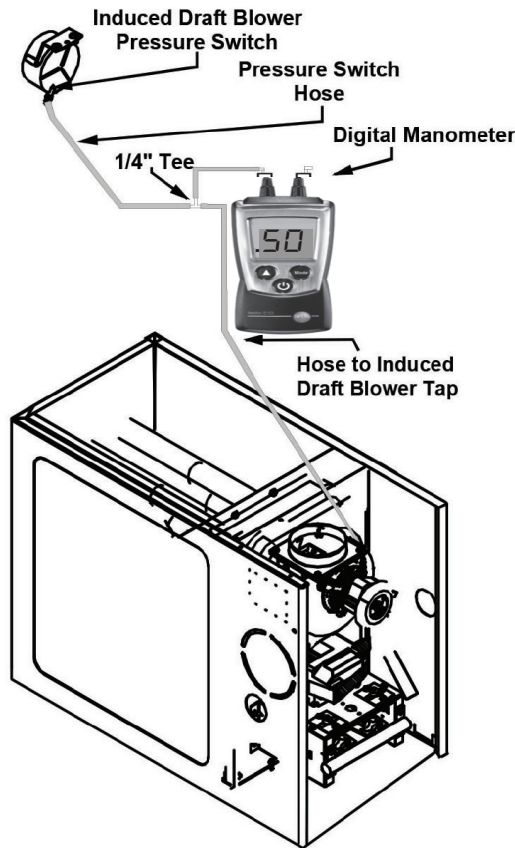

ID Blower Pressure Switch Negative Pressure Measurement
(80% Upflow Single-Stage Furnace Shown, Counterflow Similar)

HIGH ALTITUDE APPLICATION (USA)

Check your furnace rating plate to determine its rated altitude (either 4500 or 5500 ft). Do not attempt to increase the firing rate by changing orifices or increasing the manifold pressure below 4500/5500 feet. This can cause poor combustion and equipment failure. High altitude installations above 4500/5500 feet may require both a pressure switch and an orifice change. These changes are necessary to compensate for the natural reduction in the density of both the gas fuel and the combustion air at higher altitude.

For installations above 4500/5500 feet, please refer to your distributor for required kit(s). Contact the distributor for a tabular listing of appropriate manufacturer's kits for propane gas and/or high altitude installations. The indicated kits must be used to insure safe and proper furnace operation. All conversions must be performed by a qualified installer, or service agency.

In some areas the gas supplier may artificially derate the gas in an effort to compensate for the effects of altitude. If the gas is artificially derated the appropriate orifice size must be determined based on the BTU/ft³ content of the derated gas and the altitude. Refer to the National Fuel Gas Code, NFPA 54/ANSI Z223.1, and information provided by the gas supplier to determine the proper orifice size.

CHECKING FOR DELAYED IGNITION

Delayed ignition is a delay in lighting a combustible mixture of gas and air which has accumulated in the combustion chamber.

Furnace design makes this extremely unlikely unless safety controls have been by-passed or tampered with. Never by-pass or alter furnace controls.

If delayed ignition should occur, the following should be checked:

1. Improper gas pressure - Adjust to proper pressure (See *CHECKING GAS PRESSURE*).
2. Improper burner positioning - burners should be in locating slots, level front to rear and left to right.
3. Carry over (lighter tube or cross lighter) obstructed - clean.
4. Main burner orifice(s) deformed, or out of alignment to burner - replace.

CHECKING INTEGRATED IGNITION CONTROL BOARDS

NOTE: Failure to earth ground the furnace, reversing the neutral and hot wire connection to the line (polarity), or a high resistance connection in the neutral line may cause the control to lockout due to failure to sense flame.



WARNING

TO AVOID THE RISK OF ELECTRICAL SHOCK, WIRING TO THE UNIT MUST BE PROPERLY POLARIZED AND GROUNDED. DISCONNECT POWER BEFORE SERVICING LISTED BELOW.

The ground wire must run from the furnace all the way back to the electrical panel. Proper grounding can be confirmed by disconnecting the electrical power and measuring resistance between the neutral (white) connection and the burner closest to the flame sensor. Resistance should be less than 10 ohms.

The ignition control is a combination electronic and electro-mechanical device and is not field repairable. Complete unit must be replaced.

SERVICING



WARNING

LINE VOLTAGE NOW PRESENT.

These tests must be completed within a given time frame due to the operation of the ignition control.

NOTE: The models use **White-Rodgers 50X57-290**

1. Check for 120 volts from Line 1 (Hot) to Line 2 (Neutral) at the ignition control. No voltage, check the door switch connections and wire harness for continuity.
2. Check for 24 volts from W to C terminal on the ignition control. No voltage. Check transformer, room thermostat, and wiring.
If you have 24 volts coming off the transformer but receive approximately 13 volts on the terminal board between (C) and (R), check for blown fuse.
3. Check for 120 volts to the induced draft blower by measuring voltage between Pin 1 (on the 2-pin connector) and Line (Neutral) on the control board. No voltage, replace ignition control.
4. If voltage is present in Steps 1 through 3 and the induced draft blower is operating, check for 120 volts to the ignitor during the preheat cycle. Measure voltage between Pin 2 (on the 2-pin connector) and Line (Neutral) on the control board. No voltage, check pressure switch.
5. After the ignitor warmup time, begin checking for 24 volts to the gas valve. Voltage will be present for seven seconds only if proof of flame has been established.

CHECKING FLAME SENSOR

A flame sensing device is used in conjunction with the ignition control module to prove combustion. If proof of flame is not present the control will de-energize the gas valve and "retry" for ignition or lockout.

The following drawings illustrate from a bottom view, the approximate distances for the ignitor and flame sensor to the gas in shot burner. You will note they are in the main burner stream, not in the carry over ports as shown in the following figure.

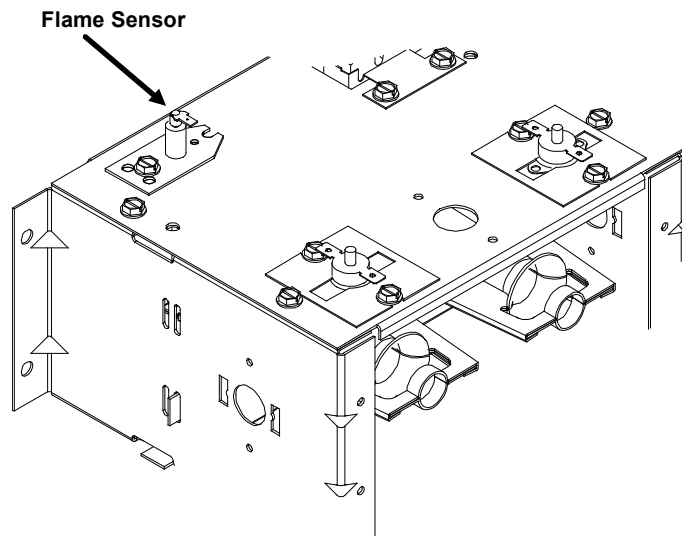

Models with Integrated Ignition Control & Flame Sensor Probe
(80% Upflow Model Shown, Counterflow Similar)



WARNING

HIGH VOLTAGE
DISCONNECT ALL POWER BEFORE SERVICING OR INSTALLING THIS UNIT. MULTIPLE POWER SOURCES MAY BE PRESENT. FAILURE TO DO SO MAY CAUSE PROPERTY DAMAGE, PERSONAL INJURY OR DEATH.



1. Disconnect the orange flame sensor wire from the sensor.
2. Connect a micro-amp meter in series with this wire and the sensor terminal.
3. Place the unit into a heating cycle.



WARNING

LINE VOLTAGE NOW PRESENT.

4. As soon as flame is established a micro-amp reading should be evident once proof of flame (micro-amp reading) is established, the hot surface ignitor will be de-energized.
5. The Integrated Ignition controls will have 1 to 4 micro-amps. If the micro-amp reading is less than the minimum specified, check for high resistance wiring connections, sensor to burner gap, dirty flame sensor, or poor grounding.
6. If absolutely no reading, check for continuity on all components and if good - replace ignition control module.

NOTE: Contaminated fuel or combustion air can create a nearly invisible coating on the flame sensor. This coating works as an insulator causing a loss in the flame sense signal. If this situation occurs the flame sensor must be cleaned with steel wool.

SERVICING

*M9S80 / *C9S80 Pressure Switch Trip Points And Usage Chart			
MODEL	ID BLOWER		
	Set Point on Pressure Fall (PF) W.C.	Max Make Pressure On Rise W.C.	Pressure Switch Part#
M9S800403A	-0.70 ±0.06	-0.85	0130F00505
M9S800603A	-0.75 ±0.07	-0.90	0130F00506
M9S800603B	-0.75 ±0.07	-0.90	0130F00506
M9S800604B	-0.75 ±0.07	-0.90	0130F00506
M9S800803B	-0.70 ±0.06	-0.85	0130F00505
M9S800804B	-0.70 ±0.06	-0.85	0130F00505
M9S800804C	-0.75 ±0.07	-0.90	0130F00506
M9S800805C	-0.75 ±0.07	-0.90	0130F00506
M9S801005C	-0.70 ±0.06	-0.85	0130F00505
M9S801205D	-0.80 ±0.05	-0.95	0130F00507
C9S800403A	-0.60 ±0.06	-0.75	0130F00504
C9S800603A	-0.60 ±0.06	-0.75	0130F00504
C9S800804B	-0.60 ±0.06	-0.75	0130F00504
C9S800805C	-0.60 ±0.06	-0.75	0130F00504
C9S801005C	-0.80 ±0.05	-0.95	0130F00507

LOW STAGE COOLING AIRFLOW										
MODEL	THERMOSTAT CALL	TAP #	EXTERNAL STATIC PRESSURE, (INCHES WATER COLUMN)							
			0.1 CFM	0.2 CFM	0.3 CFM	0.4 CFM	0.5 CFM	0.6 CFM	0.7 CFM	0.8 CFM
M9S800403A	Y/Y1	F01	658	585	545	495	444	390	332	151
		F02	749	697	652	607	554	509	459	406
		F03	925	881	840	800	760	721	681	645
		F04^	882	841	800	760	719	678	641	602
		F05	1330	1295	1273	1251	1223	1195	1168	1142
		F06	1130	1090	1059	1022	991	957	926	895
		F07	1158	1113	1090	1057	1024	996	964	935
		F08	1270	1235	1208	1179	1147	1119	1088	1060
		F09	1417	1380	1359	1336	1314	1288	1261	1238
		F10	659	599	542	490	437	383	320	N/A
M9S800603A	Y/Y1	F01	1268	1221	1188	1154	1122	1091	1060	1029
		F02	1087	1044	1008	973	938	905	871	841
		F03	1118	1070	1033	997	963	929	896	865
		F04^	1308	1262	1224	1197	1167	1141	1117	1089
		F05	868	823	780	741	699	662	624	584
		F06	922	877	835	795	757	718	679	642
		F07	1382	1341	1311	1291	1263	1234	1206	1177
		F08	1492	1448	1409	1381	1354	1332	1310	1288
		F09	720	660	614	542	468	413	359	313
		F10	1289	1260	1232	1194	1161	1125	1087	1073
M9S800603B	Y/Y1	F01	1125	1089	1052	1013	973	947	909	863
		F02	1252	1198	1153	1110	1069	1028	990	953
		F03	922	872	830	786	736	683	616	565
		F04^	1146	1113	1076	1039	1002	969	933	891
		F05	1370	1345	1317	1286	1260	1224	1187	1168
		F06	1413	1386	1360	1330	1302	1270	1242	1211
		F07	1544	1500	1459	1419	1387	1349	1317	1286
		F08	764	695	630	559	485	415	358	N/A
		F09	1287	1235	1191	1147	1104	1062	1020	979
		F10	1339	1301	1258	1217	1174	1131	1090	1048
M9S800604B	Y/Y1	F01	1396	1346	1298	1257	1217	1175	1135	1098
		F02	1185	1135	1088	1040	992	947	901	855
		F03	1500	1460	1420	1360	1340	1294	1256	1219
		F04^	1591	1539	1493	1454	1416	1379	1347	1311
		F05	1675	1622	1583	1545	1510	1474	1440	1402
		F06	1790	1741	1701	1668	1631	1599	1567	1532
		F07	710	646	580	515	432	367	314	274
		F08	1298	1255	1216	1178	1140	1102	1067	1028
		F09	1209	1166	1124	1083	1045	1005	964	923
		F10	1138	1091	1045	1001	959	920	876	832
M9S800803B	Y/Y1	F01	1391	1352	1314	1278	1241	1209	1175	1140
		F02	977	931	880	836	785	734	683	626
		F03	1036	985	940	895	848	799	751	705
		F04^	1456	1414	1376	1341	1302	1270	1238	1200
		F05	1533	1488	1452	1415	1383	1350	1317	1286
		F06	841	657	595	522	439	367	315	N/A
		F07	1141	1089	1045	1001	958	914	869	823
		F08	1311	1267	1226	1189	1150	1114	1072	1034
		F09	1395	1347	1309	1270	1233	1199	1164	1125
		F10	1490	1447	1407	1373	1336	1303	1269	1237
M9S800804C	Y/Y1	F01	1553	1510	1469	1435	1401	1368	1335	1300
		F02	1593	1548	1508	1474	1440	1409	1376	1343
		F03	1776	1735	1695	1661	1628	1601	1570	1542
		F04^	1853	1812	1773	1739	1708	1679	1650	1623
		F05	831	750	671	588	501	405	348	300
		F06	1214	1158	1103	1045	989	936	883	823
		F07	1303	1249	1191	1136	1081	1028	974	928
		F08	1426	1375	1324	1277	1229	1177	1124	1078
		F09	1518	1465	1418	1372	1328	1284	1237	1195
		F10	1588	1539	1494	1447	1401	1358	1313	1267
M9S800805C	Y/Y1	F01	1710	1666	1632	1595	1554	1512	1473	1431
		F02	1785	1751	1717	1675	1639	1596	1557	1516
		F03	1845	1805	1771	1733	1695	1655	1618	1576
		F04^	837	752	671	576	501	426	361	315
		F05	1316	1270	1218	1166	1114	1061	1000	962
		F06	1353	1323	1286	1235	1183	1131	1085	1040
		F07	1587	1544	1506	1459	1416	1372	1323	1281
		F08	1731	1673	1632	1587	1546	1506	1463	1421
		F09	1794	1744	1709	1671	1632	1591	1555	1513
		F10	1861	1805	1761	1720	1681	1642	1603	1565
M9S801005C	Y/Y1	F01	1910	1873	1839	1798	1761	1723	1686	1648
		F02	2110	2055	2035	2003	1973	1946	1907	1890
		F03	802	724	637	551	468	389	342	294
		F04^	1405	1356	1308	1262	1210	1182	1155	1102
		F05	1574	1531	1484	1440	1392	1357	1306	1256
		F06	1619	1575	1526	1489	1446	1404	1355	1313
		F07	1688	1641	1600	1557	1513	1477	1428	1381
		F08	1811	1769	1730	1686	1649	1610	1572	1525
		F09	1857	1812	1774	1733	1697	1662	1622	1586
		F10	1892	1850	1805	1774	1735	1692	1658	1621
M9S801205D	Y/Y1	F01	2116	2073	2039	2005	1981	1945	1909	1879
		F02	851	774	692	615	535	470	411	359
		F03	1677	1629	1583	1540	1498	1449	1399	1349
		F04^	1537	1489	1444	1404	1365	1322	1272	1211
		F05	1416	1365	1315	1267	1220	1163	1106	1048
		F06	1154	1098	1043	983	932	874	819	755
		F07	1806	1764	1729	1688	1654	1615	1578	1535
		F08	1869	1816	1773	1731	1693	1661	1629	1589
		F09	1947	1903	1865	1833	1802	1769	1743	1708
		F10	2107	2066	2030	1996	1963	1932	1899	1867

NOTE:
^ Default Speed

HIGH STAGE COOLING AIRFLOW										
MODEL	THERMOSTAT CALL	TAP #	EXTERNAL STATIC PRESSURE, (INCHES WATER COLUMN)							
			0.1 CFM	0.2 CFM	0.3 CFM	0.4 CFM	0.5 CFM	0.6 CFM	0.7 CFM	0.8 CFM
M9S800403A	Y2	F01	658	585	545	495	444	390	332	151
		F02	749	697	652	607	554	509	459	406
		F03	925	881	840	800	760	721	681	645
		F04	882	841	800	760	719	678	641	602
		F05^	1330	1295	1273	1251	1223	1195	1168	1142
		F06	1130	1090	1059	1022	991	957	926	895
		F07	1158	1113	1090	1057	1024	996	964	935
		F08	1270	1235	1208	1179	1147	1119	1088	1060
		F09	1417	1380	1359	1336	1314	1288	1261	1238
		F09	1417	1380	1359	1336	1314	1288	1261	1238
M9S800603A	Y2	F01	659	599	542	490	437	383	320	N/A
		F02	1268	1221	1188	1154	1122	1091	1060	1029
		F03	1087	1044	1008	973	938	905	871	841
		F04	1118	1070	1033	997	963	929	896	865
		F05^	1308	1262	1224	1197	1167	1141	1117	1089
		F06	868	823	780	741	699	662	624	584
		F07	922	877	835	795	757	718	679	642
		F08	1382	1341	1311	1291	1263	1234	1206	1177
		F09	1492	1448	1409	1381	1354	1332	1310	1288
		F09	1492	1448	1409	1381	1354	1332	1310	1288
M9S800603B	Y2	F01	720	660	614	542	468	413	359	313
		F02	1289	1260	1232	1194	1161	1125	1087	1073
		F03	1125	1089	1052	1013	973	947	909	863
		F04	1252	1198	1153	1110	1069	1028	990	953
		F05^	922	872	830	786	736	683	616	565
		F06	1146	1113	1076	1039	1002	969	933	891
		F07	1370	1345	1317	1286	1260	1224	1187	1168
		F08	1413	1386	1360	1330	1302	1270	1242	1211
		F09	1544	1500	1459	1419	1387	1349	1317	1286
		F09	1544	1500	1459	1419	1387	1349	1317	1286
M9S800604B	Y2	F01	764	695	630	559	485	415	358	N/A
		F02	1287	1235	1191	1147	1104	1062	1020	979
		F03	1339	1301	1258	1217	1174	1131	1090	1048
		F04	1396	1346	1298	1257	1217	1175	1135	1098
		F05^	1185	1135	1088	1040	992	947	901	855
		F06	1500	1460	1420	1360	1340	1294	1256	1219
		F07	1591	1539	1493	1454	1416	1379	1347	1311
		F08	1675	1622	1583	1545	1510	1474	1440	1402
		F09	1790	1741	1701	1668	1631	1599	1567	1532
		F09	1790	1741	1701	1668	1631	1599	1567	1532
M9S800803B	Y2	F01	710	646	580	515	432	367	314	274
		F02	1298	1255	1216	1178	1140	1102	1067	1028
		F03	1209	1166	1124	1083	1045	1005	964	923
		F04	1138	1091	1045	1001	959	920	876	832
		F05^	1391	1352	1314	1278	1241	1209	1175	1140
		F06	977	931	880	836	785	734	683	626
		F07	1036	985	940	895	848	799	751	705
		F08	1456	1414	1376	1341	1302	1270	1238	1200
		F09	1533	1488	1452	1415	1383	1350	1317	1286
		F09	1533	1488	1452	1415	1383	1350	1317	1286
M9S800804B	Y2	F01	841	657	595	522	439	367	315	N/A
		F02	1141	1089	1045	1001	958	914	869	823
		F03	1311	1267	1226	1189	1150	1114	1072	1034
		F04	1395	1347	1309	1270	1233	1199	1164	1125
		F05^	1490	1447	1407	1373	1336	1303	1269	1237
		F06	1553	1510	1469	1435	1401	1368	1335	1300
		F07	1593	1548	1508	1474	1440	1409	1376	1343
		F08	1776	1735	1695	1661	1628	1601	1570	1542
		F09	1853	1812	1773	1739	1708	1679	1650	1623
		F09	1853	1812	1773	1739	1708	1679	1650	1623
M9S800804C	Y2	F01	831	750	671	588	501	405	348	300
		F02	1214	1158	1103	1045	989	936	883	823
		F03	1303	1249	1191	1136	1081	1028	974	928
		F04	1426	1375	1324	1277	1229	1177	1124	1078
		F05^	1518	1465	1418	1372	1328	1284	1237	1195
		F06	1588	1539	1494	1447	1401	1358	1313	1267
		F07	1710	1666	1632	1595	1554	1512	1473	1431
		F08	1785	1751	1717	1675	1639	1596	1557	1516
		F09	1845	1805	1771	1733	1695	1655	1618	1576
		F09	1845	1805	1771	1733	1695	1655	1618	1576
M9S800805C	Y2	F01	837	752	671	576	501	426	361	315
		F02	1316	1270	1218	1166	1114	1061	1000	962
		F03	1353	1323	1286	1235	1183	1131	1085	1040
		F04	1587	1544	1506	1459	1416	1372	1323	1281
		F05^	1731	1673	1632	1587	1546	1506	1463	1421
		F06	1794	1744	1709	1671	1632	1591	1555	1513
		F07	1861	1805	1761	1720	1681	1642	1603	1565
		F08	1910	1873	1839	1798	1761	1723	1686	1648
		F09	2110	2055	2035	2003	1973	1946	1907	1890
		F09	2110	2055	2035	2003	1973	1946	1907	1890
M9S801005C	Y2	F01	802	724	637	551	468	389	342	294
		F02	1405	1356	1308	1262	1210	1182	1155	1102
		F03	1574	1531	1484	1440	1392	1357	1306	1256
		F04	1619	1575	1526	1489	1446	1404	1355	1313
		F05^	1688	1641	1600	1557	1513	1477	1428	1381
		F06	1811	1769	1730	1686	1649	1610	1572	1525
		F07	1857	1812	1774	1733	1697	1662	1622	1586
		F08	1892	1850	1805	1774	1735	1692	1658	1621
		F09	2116	2073	2039	2005	1981	1945	1909	1879
		F09	2116	2073	2039	2005	1981	1945	1909	1879
M9S801205D	Y2	F01	851	774	692	615	535	470	411	359
		F02	1677	1629	1583	1540	1498	1449	1399	1349
		F03	1537	1489	1444	1404	1365	1322	1272	1211
		F04	1416	1365	1315	1267	1220	1163	1106	1048
		F05^	1154	1098	1043	983	932	874	819	755
		F06	1806	1764	1729	1688	1654	1615	1578	1535
		F07	1869	1816	1773	1731	1693	1661	1629	1589
		F08	1947	1903	1865	1833	1802	1769	1743	1708
		F09	2107	2066	2030	1996	1963	1932	1899	1867
		F09	2107	2066	2030	1996	1963	1932	1899	1867

NOTE:
^ Default Speed

CIRCULATION AIRFLOW										
MODEL	THERMOSTAT CALL	TAP #	EXTERNAL STATIC PRESSURE, (INCHES WATER COLUMN)							
			0.1 CFM	0.2 CFM	0.3 CFM	0.4 CFM	0.5 CFM	0.6 CFM	0.7 CFM	0.8 CFM
M9S800403A	G	F01	658	585	545	495	444	390	332	151
		F02	749	697	652	607	554	509	459	406
		F03	925	881	840	800	760	721	681	645
		F04	882	841	800	760	719	678	641	602
		F05	1330	1295	1273	1251	1223	1195	1168	1142
		F06	1130	1090	1059	1022	991	957	926	895
		F07	1158	1113	1090	1057	1024	996	964	935
		F08	1270	1235	1208	1179	1147	1119	1088	1060
		F09	1417	1380	1359	1336	1314	1288	1261	1238
M9S800603A	G	F01	659	599	542	490	437	383	320	N/A
		F02	1268	1221	1188	1154	1122	1091	1060	1029
		F03	1087	1044	1008	973	938	905	871	841
		F04	1118	1070	1033	997	963	929	896	865
		F05	1308	1262	1224	1197	1167	1141	1117	1089
		F06	868	823	780	741	699	662	624	584
		F07	922	877	835	795	757	718	679	642
		F08	1382	1341	1311	1291	1263	1234	1206	1177
		F09	1492	1448	1409	1381	1354	1332	1310	1288
M9S800603B	G	F01	720	660	614	542	468	413	359	313
		F02	1289	1260	1232	1194	1161	1125	1087	1073
		F03	1125	1089	1052	1013	973	947	909	863
		F04	1252	1198	1153	1110	1069	1028	990	953
		F05	922	872	830	786	736	683	616	565
		F06	1146	1113	1076	1039	1002	969	933	891
		F07	1370	1345	1317	1286	1260	1224	1187	1168
		F08	1413	1386	1360	1330	1302	1270	1242	1211
		F09	1544	1500	1459	1419	1387	1349	1317	1286
M9S800604B	G	F01	764	695	630	559	485	415	358	N/A
		F02	1287	1235	1191	1147	1104	1062	1020	979
		F03	1339	1301	1258	1217	1174	1131	1090	1048
		F04	1396	1346	1298	1257	1217	1175	1135	1098
		F05	1185	1135	1088	1040	992	947	901	855
		F06	1500	1460	1420	1360	1340	1294	1256	1219
		F07	1591	1539	1493	1454	1416	1379	1347	1311
		F08	1675	1622	1583	1545	1510	1474	1440	1402
		F09	1790	1741	1701	1668	1631	1599	1567	1532
M9S800803B	G	F01	710	646	580	515	432	367	314	274
		F02	1298	1255	1216	1178	1140	1102	1067	1028
		F03	1209	1166	1124	1083	1045	1005	964	923
		F04	1138	1091	1045	1001	959	920	876	832
		F05	1391	1352	1314	1278	1241	1209	1175	1140
		F06	977	931	880	836	785	734	683	626
		F07	1036	985	940	895	848	799	751	705
		F08	1456	1414	1376	1341	1302	1270	1238	1200
		F09	1533	1488	1452	1415	1383	1350	1317	1286
M9S800804B	G	F01	841	657	595	522	439	367	315	N/A
		F02	1141	1089	1045	1001	958	914	869	823
		F03	1311	1267	1226	1189	1150	1114	1072	1034
		F04	1395	1347	1309	1270	1233	1199	1164	1125
		F05	1490	1447	1407	1373	1336	1303	1269	1237
		F06	1553	1510	1469	1435	1401	1368	1335	1300
		F07	1593	1548	1508	1474	1440	1409	1376	1343
		F08	1776	1735	1695	1661	1628	1601	1570	1542
		F09	1853	1812	1773	1739	1708	1679	1650	1623
M9S800804C	G	F01	831	750	671	588	501	405	348	300
		F02	1214	1158	1103	1045	989	936	883	823
		F03	1303	1249	1191	1136	1081	1028	974	928
		F04	1426	1375	1324	1277	1229	1177	1124	1078
		F05	1518	1465	1418	1372	1328	1284	1237	1195
		F06	1588	1539	1494	1447	1401	1358	1313	1267
		F07	1710	1666	1632	1595	1554	1512	1473	1431
		F08	1785	1751	1717	1675	1639	1596	1557	1516
		F09	1845	1805	1771	1733	1695	1655	1618	1576
M9S800805C	G	F01	837	752	671	576	501	426	361	315
		F02	1316	1270	1218	1166	1114	1061	1000	962
		F03	1353	1323	1286	1235	1183	1131	1085	1040
		F04	1587	1544	1506	1459	1416	1372	1323	1281
		F05	1731	1673	1632	1587	1546	1506	1463	1421
		F06	1794	1744	1709	1671	1632	1591	1555	1513
		F07	1861	1805	1761	1720	1681	1642	1603	1565
		F08	1910	1873	1839	1798	1761	1723	1686	1648
		F09	2110	2055	2035	2003	1973	1946	1907	1890
M9S801005C	G	F01	802	724	637	551	468	389	342	294
		F02	1405	1356	1308	1262	1210	1182	1155	1102
		F03	1574	1531	1484	1440	1392	1357	1306	1256
		F04	1619	1575	1526	1489	1446	1404	1355	1313
		F05	1688	1641	1600	1557	1513	1477	1428	1381
		F06	1811	1769	1730	1686	1649	1610	1572	1525
		F07	1857	1812	1774	1733	1697	1662	1622	1586
		F08	1892	1850	1805	1774	1735	1692	1658	1621
		F09	2116	2073	2039	2005	1981	1945	1909	1879
M9S801205D	G	F01	851	774	692	615	535	470	411	359
		F02	1677	1629	1583	1540	1498	1449	1399	1349
		F03	1537	1489	1444	1404	1365	1322	1272	1211
		F04	1416	1365	1315	1267	1220	1163	1106	1048
		F05	1154	1098	1043	983	932	874	819	755
		F06	1806	1764	1729	1688	1654	1615	1578	1535
		F07	1869	1816	1773	1731	1693	1661	1629	1589
		F08	1947	1903	1865	1833	1802	1769	1743	1708
		F09	2107	2066	2030	1996	1963	1932	1899	1867

AIRFLOW TABLES

GM9S80

		HEATING AIRFLOW														TEMP RANGE		
MODEL	THERMOSTAT CALL	TAP #	EXTERNAL STATIC PRESSURE, (INCHES WATER COLUMN)															
			0.1		0.2		0.3		0.4		0.5		0.6		0.7		0.8	
			CFM	RISE	CFM	RISE	CFM	RISE	CFM	RISE	CFM	RISE	CFM	RISE	CFM	RISE	CFM	RISE
M9S800403A	W/W1	F01^^	658	N/A	585	N/A	545	N/A	495	N/A	444	N/A	390	332	151	25-55		
		F02^	749	40	697	42	652	45	607	49	554	53	509	459	406			
		F03	925	32	881	34	840	35	800	37	760	39	721	681	645			
		F04	882	34	841	35	800	37	760	39	719	41	678	641	602			
M9S800603A	W/W1	F01^^	659	N/A	599	N/A	542	N/A	490	N/A	437	N/A	383	320	N/A	20-50		
		F02^	1268	35	1221	36	1188	37	1154	38	1122	40	1091	1060	1029			
		F03	1087	41	1044	43	1008	44	973	46	938	47	905	871	841			
		F04	1118	40	1070	42	1033	43	997	45	963	46	929	896	865			
M9S800603B	W/W1	F01^^	720	N/A	660	N/A	614	N/A	542	N/A	468	N/A	413	359	313	20-50		
		F02^	1289	34	1260	35	1232	36	1194	37	1161	38	1125	1087	1073			
		F03	1125	40	1089	41	1052	42	1013	44	973	46	947	909	863			
		F04	1252	36	1198	37	1153	39	1110	40	1069	42	1028	990	953			
M9S800604B	W/W1	F01^^	764	N/A	695	N/A	630	N/A	559	N/A	485	N/A	415	358	N/A	20-50		
		F02^	1287	35	1235	36	1191	37	1147	39	1104	40	1062	1020	979			
		F03	1339	33	1301	34	1258	35	1217	37	1174	38	1131	1090	1048			
		F04	1396	32	1346	33	1298	34	1257	35	1217	37	1175	1135	1098			
M9S800803B	W/W1	F01^^	710	N/A	646	N/A	580	N/A	515	N/A	432	N/A	367	314	274	35-65		
		F02^	1298	46	1255	47	1216	49	1178	50	1140	52	1102	1067	1028			
		F03	1209	49	1166	51	1124	53	1083	55	1045	57	1005	964	923			
		F04	1138	52	1091	54	1045	57	1001	59	959	62	920	876	832			
M9S800804B	W/W1	F01^^	841	N/A	657	N/A	595	N/A	522	N/A	439	N/A	367	315	N/A	35-65		
		F02^	1141	52	1089	54	1045	57	1001	59	958	62	914	869	823			
		F03	1311	45	1267	47	1226	48	1189	50	1150	52	1114	1072	1034			
		F04	1395	42	1347	44	1309	45	1270	47	1233	48	1199	1164	1125			
M9S800804C	W/W1	F01^^	831	N/A	750	N/A	671	N/A	588	N/A	501	N/A	405	348	300	35-65		
		F02^	1214	49	1158	51	1103	54	1045	57	989	60	936	883	823			
		F03	1303	45	1249	47	1191	50	1136	52	1081	55	1028	974	928			
		F04	1426	42	1375	43	1324	45	1277	46	1229	48	1177	1124	1078			
M9S800805C	W/W1	F01^^	837	N/A	752	N/A	671	N/A	576	N/A	501	N/A	426	361	315	35-65		
		F02^	1316	45	1270	47	1218	49	1166	51	1114	53	1061	1000	962			
		F03	1353	44	1323	45	1286	46	1235	48	1183	50	1131	1085	1040			
		F04	1587	37	1544	38	1506	39	1459	41	1416	42	1372	1323	1281			
M9S801005C	W/W1	F01^^	802	N/A	724	N/A	637	N/A	551	N/A	468	N/A	389	342	294	35-65		
		F02^	1405	53	1356	55	1308	57	1262	59	1210	61	1155	1102	1057			
		F03	1574	47	1531	48	1484	50	1440	51	1392	53	1357	1306	1256			
		F04	1619	46	1575	47	1526	49	1489	50	1446	51	1404	1355	1313			
M9S801205D	W/W1	F01^^	851	N/A	774	N/A	692	N/A	615	N/A	535	N/A	470	411	359	40-70		
		F02^	1677	53	1629	55	1583	56	1540	58	1498	59	1449	1399	1349			
		F03	1537	58	1489	60	1444	62	1404	63	1365	65	1322	1272	1211			
		F04^^	1416	N/A	1365	N/A	1315	N/A	1267	N/A	1220	N/A	1163	1106	1048			

NOTE:
 ^DEFAULT & RECOMMENDED
 ^^NOT RECOMMENDED FOR HEATING

AIRFLOW TABLES

GC9S80

			LOW STAGE COOLING AIRFLOW							
MODEL	THERMOSTAT CALL	TAP #	EXTERNAL STATIC PRESSURE, (INCHES WATER COLUMN)							
			0.1	0.2	0.3	0.4	0.5	0.6	0.7	0.8
			CFM	CFM	CFM	CFM	CFM	CFM	CFM	CFM
C9S800403A	Y/Y1	F01	712	663	610	559	514	462	395	337
		F02	1120	1081	1053	1022	990	955	918	887
		F03	929	891	858	815	772	737	699	664
		F04^	1073	1031	1003	969	922	891	854	822
		F05	1212	1198	1161	1138	1103	1076	1037	1007
		F06	871	830	789	743	702	665	628	583
		F07	825	784	741	694	650	609	563	520
		F08	1274	1252	1220	1195	1169	1145	1110	1084
		F09	1362	1342	1307	1273	1252	1237	1211	1185
C9S800603A	Y/Y1	F01	706	655	604	555	505	455	395	328
		F02	1035	991	951	913	876	844	807	770
		F03	932	887	844	806	767	728	689	651
		F04^	897	851	808	764	725	686	646	603
		F05	1123	1077	1041	1006	973	941	907	875
		F06	1155	1113	1074	1039	1006	974	945	913
		F07	1255	1214	1181	1147	1116	1087	1056	1028
		F08	1388	1331	1298	1266	1235	1207	1179	1151
		F09	1421	1380	1348	1318	1289	1262	1233	1207
C9S800804B	Y/Y1	F01	760	697	636	569	481	402	349	300
		F02	1286	1238	1196	1157	1117	1077	1036	998
		F03	1393	1348	1308	1270	1230	1196	1158	1123
		F04^	1459	1414	1371	1336	1297	1264	1229	1193
		F05	1753	1713	1677	1642	1611	1576	1549	1518
		F06	1309	1261	1218	1182	1142	1103	1064	1025
		F07	1580	1534	1495	1459	1429	1390	1356	1324
		F08	1523	1483	1438	1403	1370	1336	1299	1266
		F09	1643	1599	1562	1525	1491	1462	1431	1394
C9S800805C	Y/Y1	F01	1022	813	674	585	511	431	334	282
		F02	1453	1407	1332	1259	1190	1143	1064	1003
		F03	1176	1105	1020	935	864	797	729	673
		F04^	1710	1660	1613	1560	1505	1424	1353	1296
		F05	1843	1786	1747	1690	1643	1575	1497	1435
		F06	1859	1819	1779	1734	1691	1641	1593	1520
		F07	2028	1982	1946	1907	1861	1814	1749	1683
		F08	2096	2045	2006	1974	1927	1882	1818	1765
		F09	2203	2170	2138	2113	2074	2032	1990	1948
C9S801005C	Y/Y1	F01	956	777	675	587	468	377	324	296
		F02	1460	1404	1350	1299	1251	1203	1150	1098
		F03	1561	1499	1441	1385	1336	1289	1243	1197
		F04^	1628	1571	1521	1472	1425	1380	1337	1291
		F05	1714	1659	1611	1564	1519	1473	1432	1387
		F06	1833	1784	1735	1688	1645	1605	1562	1520
		F07	1899	1853	1804	1761	1720	1681	1640	1602
		F08	1926	1894	1849	1807	1764	1720	1683	1642
		F09	2222	2174	2132	2090	2053	2013	1976	1944

NOTE:
^ Default Speed

			HIGH STAGE COOLING AIRFLOW							
MODEL	THERMOSTAT CALL	TAP #	EXTERNAL STATIC PRESSURE, (INCHES WATER COLUMN)							
			0.1	0.2	0.3	0.4	0.5	0.6	0.7	0.8
			CFM	CFM	CFM	CFM	CFM	CFM	CFM	CFM
C9S800403A	Y2	F01	712	663	610	559	514	462	395	337
		F02	1120	1081	1053	1022	990	955	918	887
		F03	929	891	858	815	772	737	699	664
		F04	1073	1031	1003	969	922	891	854	822
		F05^	1212	1198	1161	1138	1103	1076	1037	1007
		F06	871	830	789	743	702	665	628	583
		F07	825	784	741	694	650	609	563	520
		F08	1274	1252	1220	1195	1169	1145	1110	1084
		F09	1362	1342	1307	1273	1252	1237	1211	1185
C9S800603A	Y2	F01	706	655	604	555	505	455	395	328
		F02	1035	991	951	913	876	844	807	770
		F03	932	887	844	806	767	728	689	651
		F04	897	851	808	764	725	686	646	603
		F05^	1123	1077	1041	1006	973	941	907	875
		F06	1155	1113	1074	1039	1006	974	945	913
		F07	1255	1214	1181	1147	1116	1087	1056	1028
		F08	1388	1331	1298	1266	1235	1207	1179	1151
		F09	1421	1380	1348	1318	1289	1262	1233	1207
C9S800804B	Y2	F01	760	697	636	569	481	402	349	300
		F02	1286	1238	1196	1157	1117	1077	1036	998
		F03	1393	1348	1308	1270	1230	1196	1158	1123
		F04	1459	1414	1371	1336	1297	1264	1229	1193
		F05^	1753	1713	1677	1642	1611	1576	1549	1518
		F06	1309	1261	1218	1182	1142	1103	1064	1025
		F07	1580	1534	1495	1459	1429	1390	1356	1324
		F08	1523	1483	1438	1403	1370	1336	1299	1266
		F09	1643	1599	1562	1525	1491	1462	1431	1394
C9S800805C	Y2	F01	1022	813	674	585	511	431	334	282
		F02	1453	1407	1332	1259	1190	1143	1064	1003
		F03	1176	1105	1020	935	864	797	729	673
		F04	1710	1660	1613	1560	1505	1424	1353	1296
		F05^	1843	1786	1747	1690	1643	1575	1497	1435
		F06	1859	1819	1779	1734	1691	1641	1593	1520
		F07	2028	1982	1946	1907	1861	1814	1749	1683
		F08	2096	2045	2006	1974	1927	1882	1818	1765
		F09	2203	2170	2138	2113	2074	2032	1990	1948
C9S801005C	Y2	F01	956	777	675	587	468	377	324	296
		F02	1460	1404	1350	1299	1251	1203	1150	1098
		F03	1561	1499	1441	1385	1336	1289	1243	1197
		F04	1628	1571	1521	1472	1425	1380	1337	1291
		F05^	1714	1659	1611	1564	1519	1473	1432	1387
		F06	1833	1784	1735	1688	1645	1605	1562	1520
		F07	1899	1853	1804	1761	1720	1681	1640	1602
		F08	1926	1894	1849	1807	1764	1720	1683	1642
		F09	2222	2174	2132	2090	2053	2013	1976	1944

NOTE:
 ^ Default Speed

AIRFLOW TABLES

GC9S80

MODEL	THERMOSTAT CALL	TAP #	CIRCULATION AIRFLOW							
			EXTERNAL STATIC PRESSURE, (INCHES WATER COLUMN)							
			0.1	0.2	0.3	0.4	0.5	0.6	0.7	0.8
			CFM	CFM	CFM	CFM	CFM	CFM	CFM	CFM
C9S800403A	G	F01	712	663	610	559	514	462	395	337
		F02	1120	1081	1053	1022	990	955	918	887
		F03	929	891	858	815	772	737	699	664
		F04	1073	1031	1003	969	922	891	854	822
		F05	1212	1198	1161	1138	1103	1076	1037	1007
		F06	871	830	789	743	702	665	628	583
		F07	825	784	741	694	650	609	563	520
		F08	1274	1252	1220	1195	1169	1145	1110	1084
		F09	1362	1342	1307	1273	1252	1237	1211	1185
C9S800603A	G	F01	706	655	604	555	505	455	395	328
		F02	1035	991	951	913	876	844	807	770
		F03	932	887	844	806	767	728	689	651
		F04	897	851	808	764	725	686	646	603
		F05	1123	1077	1041	1006	973	941	907	875
		F06	1155	1113	1074	1039	1006	974	945	913
		F07	1255	1214	1181	1147	1116	1087	1056	1028
		F08	1388	1331	1298	1266	1235	1207	1179	1151
		F09	1421	1380	1348	1318	1289	1262	1233	1207
C9S800804B	G	F01	760	697	636	569	481	402	349	300
		F02	1286	1238	1196	1157	1117	1077	1036	998
		F03	1393	1348	1308	1270	1230	1196	1158	1123
		F04	1459	1414	1371	1336	1297	1264	1229	1193
		F05	1753	1713	1677	1642	1611	1576	1549	1518
		F06	1309	1261	1218	1182	1142	1103	1064	1025
		F07	1580	1534	1495	1459	1429	1390	1356	1324
		F08	1523	1483	1438	1403	1370	1336	1299	1266
		F09	1643	1599	1562	1525	1491	1462	1431	1394
C9S800805C	G	F01	1022	813	674	585	511	431	334	282
		F02	1453	1407	1332	1259	1190	1143	1064	1003
		F03	1176	1105	1020	935	864	797	729	673
		F04	1710	1660	1613	1560	1505	1424	1353	1296
		F05	1843	1786	1747	1690	1643	1575	1497	1435
		F06	1859	1819	1779	1734	1691	1641	1593	1520
		F07	2028	1982	1946	1907	1861	1814	1749	1683
		F08	2096	2045	2006	1974	1927	1882	1818	1765
		F09	2203	2170	2138	2113	2074	2032	1990	1948
C9S801005C	G	F01	956	777	675	587	468	377	324	296
		F02	1460	1404	1350	1299	1251	1203	1150	1098
		F03	1561	1499	1441	1385	1336	1289	1243	1197
		F04	1628	1571	1521	1472	1425	1380	1337	1291
		F05	1714	1659	1611	1564	1519	1473	1432	1387
		F06	1833	1784	1735	1688	1645	1605	1562	1520
		F07	1899	1853	1804	1761	1720	1681	1640	1602
		F08	1926	1894	1849	1807	1764	1720	1683	1642
		F09	2222	2174	2132	2090	2053	2013	1976	1944

AIRFLOW TABLES

GC9S80

		HEATING AIRFLOW												TEMP RANGE				
MODEL	THERMOSTAT CALL	TAP #	EXTERNAL STATIC PRESSURE, (INCHES WATER COLUMN)															
			0.1		0.2		0.3		0.4		0.5		0.6		0.7		0.8	
			CFM	RISE	CFM	RISE	CFM	RISE	CFM	RISE	CFM	RISE	CFM	RISE	CFM	CFM	CFM	
C9S800403A	W/W1	F01^^	712	N/A	663	N/A	610	N/A	559	N/A	514	N/A	462	395	337			25-55
		F02^	1120	26	1081	27	1053	28	1022	29	990	30	955	918	887			
		F03	929	32	891	33	858	35	815	36	772	38	737	699	664			
		F04	1073	28	1031	29	1003	30	969	31	922	32	891	854	822			
C9S800603A	W/W1	F01^^	706	N/A	655	N/A	604	N/A	555	N/A	505	N/A	455	395	328			30-60
		F02^	1035	43	991	45	951	47	913	49	876	51	844	807	770			
		F03	932	48	887	50	844	53	806	55	767	58	728	689	651			
		F04^^	897	N/A	851	N/A	808	N/A	764	N/A	725	N/A	686	646	603			
C9S800804B	W/W1	F01^^	760	N/A	697	N/A	636	N/A	569	N/A	481	N/A	402	349	300			35-65
		F02^	1286	46	1238	48	1196	50	1157	51	1117	53	1077	1036	998			
		F03	1393	43	1348	44	1308	45	1270	47	1230	48	1196	1158	1123			
		F04	1459	41	1414	42	1371	43	1336	44	1297	46	1264	1229	1193			
C9S800805C	W/W1	F01^^	1022	N/A	813	N/A	674	N/A	585	N/A	511	N/A	431	334	282			35-65
		F02^	1453	41	1407	42	1332	45	1259	47	1190	50	1143	1064	1003			
		F03^^	1176	N/A	1105	N/A	1020	N/A	935	N/A	864	N/A	797	729	673			
		F04	1710	35	1660	36	1613	37	1560	38	1505	39	1424	1353	1296			
C9S801005C	W/W1	F01^^	956	N/A	777	N/A	675	N/A	587	N/A	468	N/A	377	324	296			40-70
		F02^	1460	51	1404	53	1350	55	1299	57	1251	59	1203	1150	1098			
		F03	1561	47	1499	49	1441	51	1385	53	1336	55	1289	1243	1197			
		F04	1628	46	1571	47	1521	49	1472	50	1425	52	1380	1337	1291			

NOTE:
 ^DEFAULT & RECOMMENDED
 ^^NOT RECOMMENDED FOR HEATING

1 STAGE STATUS CODES

Menu Description	LED Display		Notes
	Main Menu	Option Menu	
Active Alarm menu	<i>E r r</i>	Exx	(xx: code numbers)
Last 6 Faults	<i>L6F</i>	Exx	(xx: code numbers)
Code Release Number	<i>Cr</i>	CR Number	
Reset to Factory Default	<i>rFd</i>	yes, no	
Blower Speed for Continuous Fan Mode	<i>F5d</i>	Fxx	(xx: Blower Speed Number F01, F02..)
Blower Speed for 1st Stage Compressor Mode	<i>FC1</i>	Fxx	(xx: Blower Speed Number F01, F02..)
Blower Speed for 2nd Stage Compressor Mode	<i>FC2</i>	Fxx	(xx: Blower Speed Number F01, F02..)
Cool On Delay	<i>Cnd</i>	Delay, Seconds	Default set at 7 Secs, Adjustments can be made in 7 Secs increments from 0 to 35 Secs
Cool Off Delay	<i>COd</i>	Delay, Seconds	Default set at 65 Secs, Adjustments can be made in 5 Secs increments from 0 to 120 Secs
Blower Speed for Gas Heat Mode	<i>GF</i>	Fxx	(xx: Blower Speed Number F01, F02..)
Gas Heat On Delay	<i>Gnd</i>	Delay, Seconds	Default set at 30 Secs, Adjustments can be made in 5 Secs increments from 5 to 30 Secs
Gas heat Off Delay	<i>GFd</i>	Delay, Seconds	Default set at 90 Secs, Adjustments can be made in 30 Secs increments from 30 to 180 Secs
Automatic Heat Staging - For Two Stage Control	<i>AE</i>	no, 10, 20, 30, 60, AUt	Refer to Section " CHANGING HEATING MODE SETTING"

1 STAGE STATUS CODES

STATUS MENU

Mode	Main Menu
Idle	<i>IDL</i>
Continuous Fan	<i>FAN</i>
Compressor Cooling, Low Stage	<i>1RC</i>
Compressor Cooling, High Stage	<i>2RC</i>
Gas heat - Single Stage Control	<i>GH</i>
OEM test Mode	<i>EDL</i>

1 STAGE TROUBLESHOOTING CODES

TROUBLESHOOTING CHART			
Symptom	LED Status	Fault Description	Corrective Actions
Normal operation	<i>L 5 F</i>	Normal operation	None
Furnace fails to operate	<i>EE0</i>	Furnace lockout due to an excessive number of ignition "retries" (3 total) Failure to establish flame Loss of flame after establishment	Locate and correct gas interruption Replace or realign igniter Check flame sense signal, clean sensor if coated or oxidized Check flue piping for blockage, proper length, elbows, and termination Verify proper induced draft blower performance
Furnace fails to operate	<i>EE1</i>	Pressure switch circuit is closed at start of heating cycle Pressure switch contacts sticking Short in pressure switch circuit wiring	Replace low stage pressure switch Repair short in wiring
Induced draft blower runs continuously with no furnace operation	<i>EE2</i>	Pressure switch circuit is not closed Pressure switch hose blocked/pinched, or connected improperly Blocked flue and/or inlet air pipe, blocked drain system or weak induced draft blower Incorrect pressure switch set point or malfunctioning switch contacts Loose or improperly connected wiring	Inspect pressure switch hose, repair/replace if necessary Inspect flue piping for blockage, proper length, elbows, and termination Check induced draft blower performance, correct as necessary Check pressure switch operation, replace as needed Tighten or correct wiring connection
Circulator blower runs continuously No furnace operation	<i>EE3</i>	Primary limit circuit is open Insufficient conditioned air over the heat exchanger Blocked filters, restrictive ductwork, improper circulator blower speed, or failed circulator blower motor Loose or improperly connected wiring in high limit circuit	Check filters and ductwork for blockage Clean filters or remove obstruction Check circulator blower speed and performance Correct speed or replace blower motor if necessary Tighten or correct wiring connection
Induced draft blower and circulator blower runs continuously No furnace operation	<i>EE4</i>	Flame sensed with no call for heat Short to ground in flame sense circuit Lingering burner flame Slow closing gas valve	Correct short at flame sensor or in flame sensor wiring Check for lingering or lazy flame Verify proper operation of gas valve
No furnace operation	<i>EE5</i>	Open fuse Short in low voltage wiring	Replace fuse Locate and correct short in low voltage wiring

To VIEW & CLEAR FAULT CODES

- Press either the Left or Right switch until *L 5 F* is displayed.
- Press the center switch to view stored faults.
- Press and hold the center switch for 5 to 30 seconds.
- All stored faults will be erased, and the display will flash - - - three times and return to *L 5 F*.

1 STAGE TROUBLESHOOTING CODES

TROUBLESHOOTING CHART			
Symptom	LED Status	Fault Description	Corrective Actions
Normal furnace operation	EEB	Flame sense micro amp signal is minimal Flame sensor is coated/oxidized Flame sensor incorrectly positioned in burner fame Lazy burner flame due to improper gas pressure or combustion air	Clean flame sensor if coated or oxidized Inspect for proper flame sensor alignment Compare current gas pressure to rating plate and adjust as needed
Furnace fails to operate	EEL	Problem with igniter circuit Improperly connected or shorted igniter Poor unit ground Igniter relay fault on integrated control module	Check and correct wiring from integrated control module to igniter Diagnose and replace shorted igniter as needed Verify and correct unit ground wiring if needed Check igniter output from control, replace if necessary
Furnace fails to operate	EEA	Polarity of 115 volt AC is reversed Poor unit ground	Correct polarity, check and correct wiring if necessary Verify proper ground, correct if necessary
Furnace fails to operate	EEb	Gas valve is not energized when it should be External Gas Valve Error	Check wiring in gas valve circuit Replace integrated control board
Furnace fails to operate	EEc	Gas valve is energized when it should not be Internal gas valve error	Check wiring in gas valve circuit Replace integrated control board
Furnace fails to operate. Integrated control module LED display provides no signal	None	No 115 power to furnace or no 24 volt power to integrated control module. Blown fuse or tripped circuit breaker Integrated control module is non- functional	Restore high voltage power to furnace and integrated control module. Correct condition which caused fuse to open, replace fuse Replace non-functional integrated control module.
Furnace fails to operate	E 10	Grounding fault Poor neutral connection	Verify neutral wire connection to furnace & continuity to ground source
Furnace fails to operate	E 11	Open roll out switch	Check for correct gas pressure Check for correct burner alignment Check for and correct burner restriction
Furnace fails to operate	EEr	Ignitor Open	Check for Ignitor wiring. Replace Damaged Ignitor
Furnace fails to operate	EEJ	Inducer relay Error	Replace integrated control board
Twinning feature not working	EEH	TWIN Error	Check for wiring connections. Replace integrated control board
Furnace fails to operate	EEE	Internal Faults or IRQ Loss in Control Board	Replace integrated control board

CUSTOMER FEEDBACK

We are very interested in all product comments.

Please fill out the feedback form on one of the following links:

Goodman® Brand Products: (<http://www.goodmanmfg.com/about/contact-us>).

Amana® Brand Products: (<http://www.amana-hac.com/about-us/contact-us>).

You can also scan the QR code on the right for the product brand you purchased to be directed to the feedback page.



GOODMAN® BRAND



AMANA® BRAND