

HKR / HKA / HKP ELECTRIC HEAT KIT

INSTALLATION INSTRUCTIONS

ATTENTION INSTALLING PERSONNEL

As a professional installer, you have an obligation to know the product better than the customer. This includes all safety precautions and related items.

Prior to actual installation, thoroughly familiarize yourself with this Instruction Manual. Pay special attention to all safety warnings. Often during installation or repair, it is possible to place yourself in a position which is more hazardous than when the unit is in operation.

Remember, it is **your** responsibility to install the product safely and to know it well enough to be able to instruct a customer in its safe use.

Safety is a matter of common sense...a matter of thinking before acting. Most dealers have a list of specific good safety practices...follow them.

The precautions listed in this Installation Manual are intended as supplemental to existing practices. However, if there is a direct conflict between existing practices and the content of this manual, the precautions listed here take precedence.

SAFETY PRECAUTIONS

The following symbols and labels are used throughout this manual to indicate immediate or potential safety hazards. It is the owner's and installer's responsibility to read and comply with all safety information and instructions accompanying these symbols. Failure to heed safety information increases the risk of personal injury, property damage, and/or product damage.

WARNING

HIGH VOLTAGE !

DISCONNECT ALL POWER BEFORE SERVICING.
MULTIPLE POWER SOURCES MAY BE PRESENT. FAILURE TO DO SO MAY CAUSE PROPERTY DAMAGE, PERSONAL INJURY OR DEATH.



WARNING

ONLY INDIVIDUALS MEETING THE REQUIREMENTS OF AN "ENTRY LEVEL TECHNICIAN" AS SPECIFIED BY THE AIR CONDITIONING, HEATING, AND REFRIGERATION INSTITUTE (AHRI) MAY USE THIS INFORMATION. ATTEMPTING TO INSTALL OR REPAIR THIS UNIT WITHOUT SUCH BACKGROUND MAY RESULT IN PRODUCT DAMAGE, PERSONAL INJURY, OR DEATH.

WARNING

THIS APPLIANCE **MUST** BE INSTALLED FOLLOWING THE ANSI/NFPA 70 (NATIONAL ELECTRIC CODE) AND OTHER APPLICABLE CODES.







WARNING

FAILURE TO FOLLOW THESE INSTRUCTIONS CAN CAUSE FIRE, EXPLOSION, ELECTRICAL SHOCK, PROPERTY DAMAGE, PERSONAL INJURY OR DEATH.

CAUTION

TO AVOID POSSIBLE PERSONAL INJURY, USE EXTREME CAUTION IN USING POWER TOOLS TO REMOVE THE SMALL BREAKER MOUNTING BRACKETS. THE BRACKETS MAY QUICKLY ROTATE AND CAUSE INJURY. OR DEATH.



 DANGER	 DANGER PELIGRO	 DANGER
		
CARBON MONOXIDE POISONING HAZARD Special Warning for Installation of Furnace or Air Handling Units in Enclosed Areas such as Garages, Utility Rooms or Parking Areas	RIESGO DE INTOXICACIÓN POR MONÓXIDO DE CARBONO Advertencia especial para la instalación de calentadores ó manejadoras de aire en áreas cerradas como estacionamientos ó cuartos de servicio.	RISQUE D'EMPOISONNEMENT AU MONOXYDE DE CARBONE Advertencia especial para la instalación de calentadores ó manejadoras de aire en áreas cerradas como estacionamientos ó cuartos de servicio.
Carbon monoxide producing devices (such as an automobile, space heater, gas water heater, etc.) should not be operated in enclosed areas such as unventilated garages, utility rooms or parking areas because of the danger of carbon monoxide (CO) poisoning resulting from the exhaust emissions. If a furnace or air handler is installed in an enclosed area such as a garage, utility room or parking area and a carbon monoxide producing device is operated therein, there must be adequate, direct outside ventilation. This ventilation is necessary to avoid the danger of CO poisoning which can occur if a carbon monoxide producing device continues to operate in the enclosed area. Carbon monoxide emissions can be (re)circulated throughout the structure if the furnace or air handler is operating in any mode.	Los equipos ó aparatos que producen monóxido de carbono (tal como automóvil, calentador de gas, calentador de agua por medio de gas, etc) no deben ser operados en áreas cerradas debido al riesgo de envenenamiento por monóxido de carbono (CO) que resulta de las emisiones de gases de combustión. Si el equipo ó aparato se opera en dichas áreas, debe existir una adecuada ventilación directa al exterior. Esta ventilación es necesaria para evitar el peligro de envenenamiento por CO, que puede ocurrir si un dispositivo que produce monóxido de carbono sigue operando en el lugar cerrado. Las emisiones de monóxido de carbono pueden circular a través del aparato cuando se opera en cualquier modo.	Avertissement special au sujet de l'installation d'appareils de chauffage ou de traitement d'air dans des endroits clos, tels les garages, les locaux d'entretien et les stationnements. Evitez de mettre en marche les appareils produisant du monoxyde de carbone (tels que les automobile, les appareils de chauffage autonome, etc.) dans des endroits non ventilés tels que les d'empoisonnement au monoxyde de carbone. Si vous devez faire fonctionner ces appareils dans un endroit clos, assurez-vous qu'il y ait une ventilation directe provenant de l'exterieur. Cette ventilation est nécessaire pour éviter le danger d'intoxication au CO pouvant survenir si un appareil produisant du monoxyde de carbone continue de fonctionner au sein de la zone confinée.
CO can cause serious illness including permanent brain damage or death. B10259-216	El monóxido de carbono puede causar enfermedades severas como daño cerebral permanente ó muerte. B10259-216	Les émissions de monoxyde de carbone peuvent etre recircules dans les endroits clos, si l'appareil de chauffage ou de traitement d'air sont en marche. Le monoxyde de carbone peut causer des maladies graves telles que des dommages permanents au cerveau et meme la mort. B10259-216

SHIPPING INSPECTION

All units are securely packed in shipping containers tested according to International Safe Transit Association specifications. The carton must be checked upon arrival for external damage. If damage is found, a request for inspection by carrier's agent must be made in writing immediately.

Inspect the kit carefully on arrival for damage and bolts or screws which may have come loose in transit. In the event of damage the consignee should:

1. Make a notation on delivery receipt of any visible damage to shipment or container.
2. Notify carrier promptly and request an inspection.
3. With concealed damage, carrier must be notified as soon as possible - preferably within five days.
4. File the claim with the following support documents within a nine month statute of limitations.
 - Original or certified copy of the Bill of Lading, or indemnity bond.
 - Original paid freight bill or indemnity in lieu thereof.
 - Original or certified copy of the invoice, showing trade and other discounts or reductions.
 - Copy of the inspection report issued by carrier's representative at the time damage is reported to carrier.

The carrier is responsible for making prompt inspection of damage and for a thorough investigation of each claim. The distributor or manufacturer will not accept claims from dealers for transportation damage.

STANDARD AIR HANDLER INSTALLATION

 **WARNING**

TO PREVENT PERSONAL INJURY OR DEATH WHEN INSTALLING IN A GARAGE, THE ELEMENT MUST BE AT LEAST 18" ABOVE THE FLOOR.

 **CAUTION**

TO AVOID PROPERTY DAMAGE OR PERSONAL INJURY DUE TO FIRE, USE ONLY COPPER CONDUCTORS.

NOTE: When installing in a garage, the element **MUST** be at least 18" above the floor.

1. Remove the upper access panel from the air handler.
2. Remove the block-off plate from the air handler.
3. Slide the heater kit into the slot following the direction of airflow decal attached to the heater faceplate and secure using the screws previously removed.

NOTE: Steps 4 through 7 and step 10 pertain to kits that contain circuit breakers.

 **WARNING**

HIGH VOLTAGE !

DISCONNECT ALL POWER BEFORE SERVICING.
MULTIPLE POWER SOURCES MAY BE PRESENT. FAILURE TO DO SO MAY CAUSE PROPERTY DAMAGE, PERSONAL INJURY OR DEATH.



4. Remove the circuit breaker mounting bracket, leaving the circuit breakers connected.
5. **MBVC and MBR models**
Mount the circuit breaker mounting bracket as shown using the supplied screws. Insert two of the screws through the blower deck from the blower side. Insert the remaining screws in the holes provided on the upper right side of the jacket.

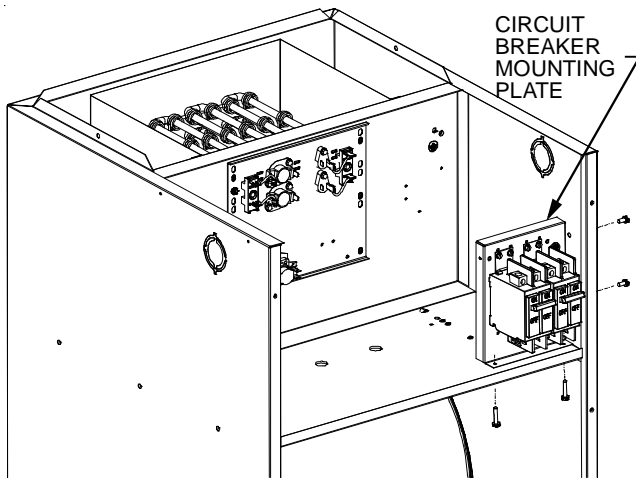



Figure 1

NOTE: HKA-15C replaces HKR-15C and HKA-20C replaces HKR-20C in air handlers.

6. Insert the breaker with OFF position oriented down.
NOTE: In the horizontal position, the direction does not matter. In some cases, it will be easier to wire the breakers before reinserting them into the mounting bracket.
7. Insert power leads into the lugs provided on the circuit breaker and tighten. **The power leads MUST be routed through a strain relief as they enter the cabinet.**
8. Remove the multi-pin connector with the jumper wire and discard. Insert the one contained in the kit. It can be inserted in one position only.

9. Insert the provided ground wire into the lug(s).
10. Remove the screws holding the clear breaker cover and remove cover. Cut out the insulation to expose the breaker/breakers. Reinstall the clear plastic cover with the screws to seal opening.
11. Replace panel and check operation.
12. Apply the wiring diagram over the one found on the air handlers. On the "MBVC" Airhandler wiring diagram which is included, mark an "X" on the wiring diagram according to the number of Heater Element rows installed.
13. If installing an HKA heater kit on a unit that only has the corresponding HKR heater kit shown on the serial plate, use a permanent marker to add the HKA model to the serial plate (the data is the same as the HKR). If the corresponding HKR model number is not on the serial plate, the heater kit cannot be used.

THREE-PHASE UNIT INSTALLATION

 **WARNING**

HIGH VOLTAGE !

TO AVOID THE RISK OF ELECTRICAL SHOCK, A MEANS OF STRAIN RELIEF AND CONDUCTOR PROTECTION MUST BE PROVIDED AT THE SUPPLY WIRE ENTRANCE.



1. Follow steps 1 through 4 from "Standard Air Handler Installation" section.
2. Using the two 1" screws provided, mount the terminal block on the right hand side of the heater panel on the airhandler (mounting holes are provided).
3. Wire the terminal block leads to the transformer as per the wiring diagram.
4. Insert single phase power leads into lugs provided on the terminal block and tighten.
5. Insert three-phase power leads into lugs provided on the contactor and tighten. **The power leads MUST be routed through a strain relief as they enter the cabinet.**
6. Follow steps 9, 10, 11 and 12 from "Standard Air Handler Installation" section.

"H" SERIES PACKAGE UNIT INSTALLATION

NOTE: A separate power supply is required for the HKR/ HKP heater kits.

WARNING

HIGH VOLTAGE !

TO AVOID THE RISK OF ELECTRICAL SHOCK, A MEANS OF STRAIN RELIEF AND CONDUCTOR PROTECTION MUST BE PROVIDED AT THE SUPPLY WIRE ENTRANCE.



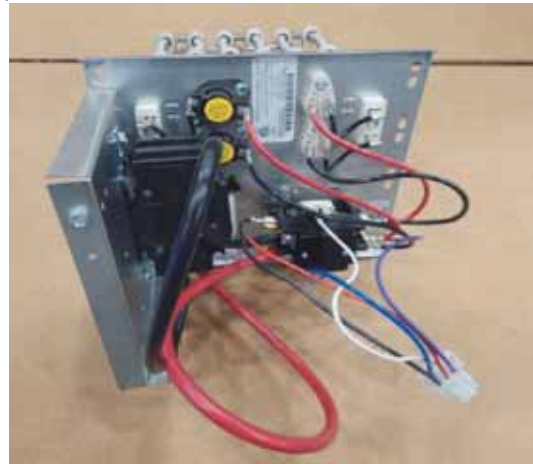

Figure 2

1. Disconnect all power to the unit, both indoor and outdoor.
2. Remove the control box cover and blower panel.
3. Remove cover to the electric heat kit box.
4. Break out appropriate knockout for electric heat kit based on kW of element (# of elements).
5. Remove heater kit from packaging.

For kits that contain circuit breakers:

6. Remove screws attaching circuit breaker plate (Figure 2 and 3).

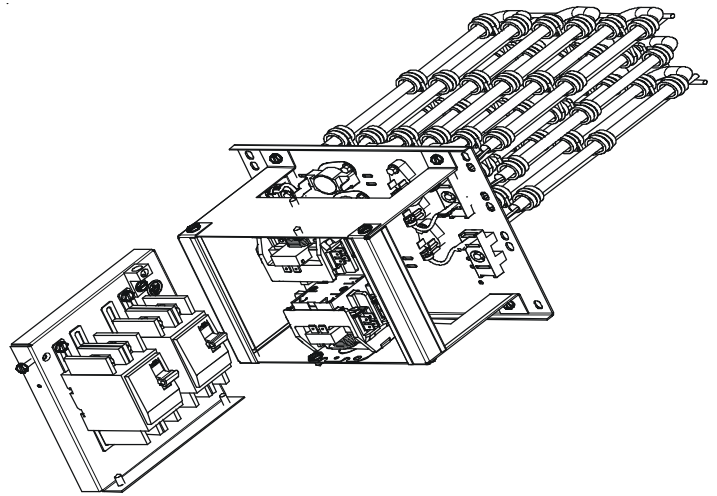

Figure 3

For 15kW and 20kW kits:

7. Remove screws attaching the contactors (quantity 2) to horseshoe contactor bracket (Figure 4).

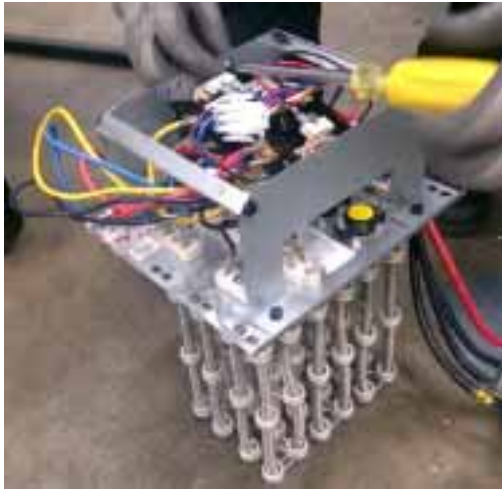

Figure 4

8. Remove four (4) screws attaching the horseshoe contactor bracket and lift off of heater plate (Figure 5).



Figure 5

9. Attach contactors to included "H" model vertical contactor plate. Ensure contactor lugs are pointed inward towards each other.
10. Slide the heater kit into the slot following the direction of airflow decal for package unit operation attached to the heater faceplate and secure with screws provided.
11. Install two of the four mounting screws on heaterkit (Figure 6).



Figure 6

12. Place vertical contactor bracket behind corner post.
13. Secure vertical contactor plate and heater kit to unit using remaining two mounting screws (Figure 7).



Figure 7

NOTE: Steps 14 and 17 pertain to kits *that contain circuit breakers*.

14. Attach the circuit breaker mounting bracket inside the top left corner of the electric heat kit box (Figure 8 and 9). Ensure the breaker is oriented with OFF position to the left. Remove the two (2) sheet metal screws prior to installation and re-attach as shown in Figure 8.



Figure 8



Figure 9

NOTE: In some cases, it will be easier to wire the breakers BEFORE inserting them into the electric heat kit box. If rewiring is desired, reference the included wiring diagram to ensure correct wiring.

15. Insert the power leads into the lugs provided on the circuit breaker or terminal block and tighten. Ensure the power leads are routed through the outer cabinet with a watertight electrical connector, sized appropriately for the electrical power supply (see NEC, National Electric Code).

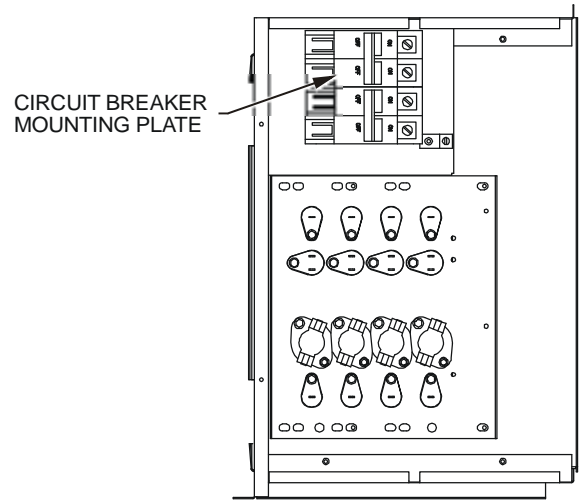

Figure 10

16. Remove the protection plug (male plug) and discard. Insert the one provided in the electric heat kit. It can be inserted in one position only.
17. Insert the ground wire into the lug(s) provided for that purpose.
18. Break out the appropriate area of the electric heat kit cover previously removed for the circuit breaker provided in the heater kit and replace electric heat kit cover.

NOTE: To replace the electric heat kit cover, slightly tip the cover and insert only the notches under the flanges on the top and bottom of the box. Secure with screws. See Figure 11.

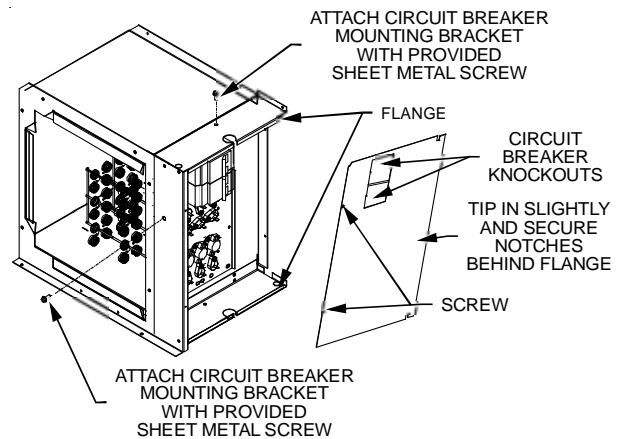

Figure 11

19. Ensure breaker is in the ON position. Replace blower panel cover and check operation through the room thermostat.
20. RESTORE POWER.
21. Apply the provided wiring diagram for package unit models adjacent to the wiring diagram supplied on the inside of the unit control box cover.
22. When proper operation is ensured, replace the control box cover and resume normal operation.

NOTE: *In Package Units:*

HKP-05C replaces HKR-05C

HKP-10C replaces HKR-10C

HKP-15C replaces HKR-15C

HKP-20C replaces HKR-20C

23. If installing an HKP heater kit on a unit that only has the corresponding HKR heater kit shown on the serial plate, use a permanent marker to add the HKP model to the serial plate (the data is the same as the HKR). If the corresponding HKR model number is not on the serial plate, the heater kit can not be used.

"M" SERIES PACKAGE UNIT INSTALLATION

NOTE: A separate power supply is required for the HKR heater kits.

⚠ WARNING

HIGH VOLTAGE !

DISCONNECT ALL POWER BEFORE SERVICING.
 MULTIPLE POWER SOURCES MAY BE PRESENT. FAILURE TO DO SO MAY CAUSE PROPERTY DAMAGE, PERSONAL INJURY OR DEATH.



1. Disconnect all power to the unit, both indoor and outdoor.
2. Remove control box door.
3. Remove blower door.
4. Locate heater box. Remove the two screws holding the heater box cover in place (Figure 12).

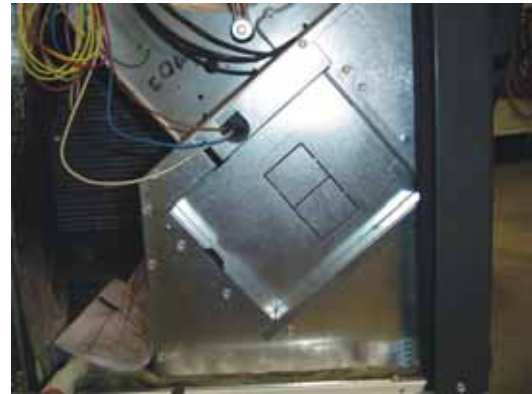

Figure 12

5. Remove the two screws holding the rear mounting plate. Note the orientation of the heater box covers for reassembly.

NOTE: For "M" Series Package Unit Installations, do not remove the horseshoe contractor bracket (on 15kW or 20kW heater kits).

6. ***Three-Phase HKR Kits only***

Remove the contactor from the HKR mounting bracket, leaving the wires connected. Attach contactor to rear mounting plate as shown in Figure 13.



Figure 13

7. Install heater element(s) with the four (4) pointed screws included in the unit literature bag. Note the air flow direction label located on the heater element base shown in Figures 14 and 15. Orient the heating element base to match airflow direction on package unit blower assembly. Ensure screws attaching horseshoe contractor plate fit into relief cuts of package unit.

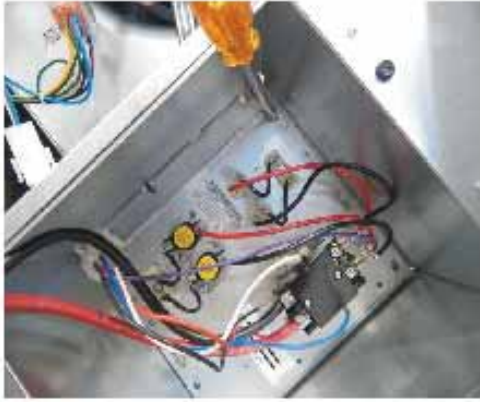

Figure 14

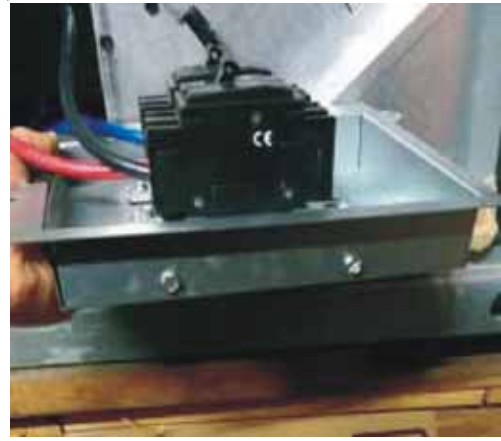

Figure 16



Figure 15

9. Locate the 9-pin harness in the unit and remove the male plug (Figures 17 and 18).

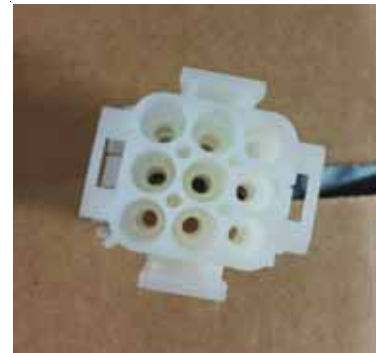

Figure 17

8. *Single Phase HKR Kits only*

Mount the breaker (or terminal block) to the rear mounting plate using the four (4) blunt tip screws included in the unit literature bag. The screw heads should all be located on the outside of the mounting plate as shown in Figure 16.

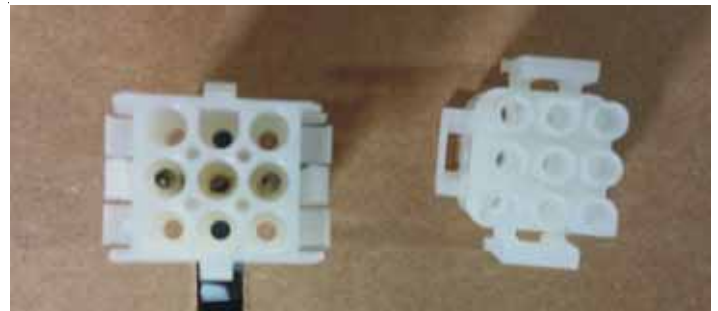

Figure 18

10. Connect the 9-pin plug from the unit to the 9-pin plug in the heater kit.
11. Feed the 9-pin harness wires through the rubber grommet, and feed the HKR wires through the plastic bushing in the rear mounting plate. See Figure 19. Ensure 6 gauge wires are going through heater kit cover holes. Tuck excess into side of unit and route wires over top of horseshoe plate.



Figure 19

12. Install rear mounting plate with the two (2) screws removed in step 5.
13. Connect the line voltage leads to the breaker(s), terminal block, or contactor as applicable.
14. If heat kit includes breakers, remove rectangular knockout(s) from outside cover as required for access.
15. Install the cover with the two (2) screws removed in step 4, routing the line voltage wires through the rubber grommet as shown in Figure 20.



Figure 20

16. Install control box door and blower door.
17. Reconnect power and test.

NOTE: *In Package Units:*

HKP-05C replaces HKR-05C

HKP-10C replaces HKR-10C

HKP-15C replaces HKR-15C

HKP-20C replaces HKR-20C

NOTE: If installing an HKP heater kit on a unit that only has the corresponding HKR heater kit shown on the serial plate, use a permanent marker to add the HKP model to the serial plate (the data is the same as the HKR). If the corresponding HKR model number is not on the serial plate, the heater kit can not be used.

NOTE: On earlier (M) models it may be necessary to notch or cut heater kit shroud to accommodate screws in heater (Figure 21).

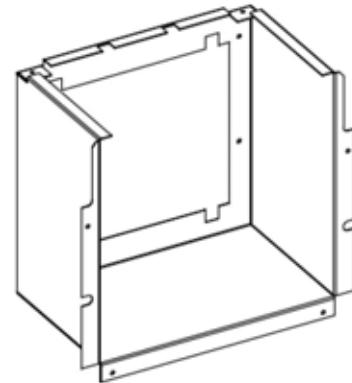
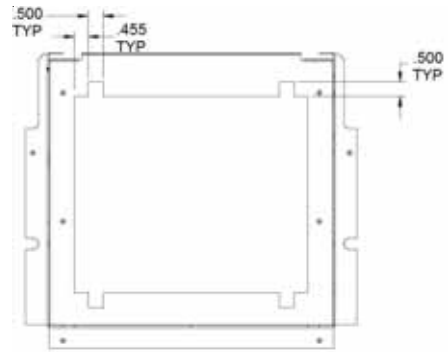

Figure 21

NOTE: To accommodate 6-gauge wires, it may be necessary to make cuts as shown on the heater kit cover. Ensure grommet edging is used along sharp edges to prevent injury (Figure 22).



Figure 22

NOTE: If necessary to connect line power to unit, drill a 1" hole at the coordinates provided in Figure 23.

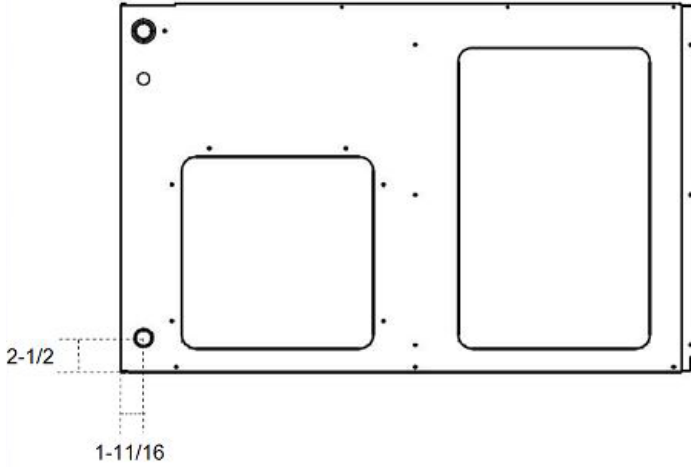

Figure 23

THIS PAGE IS INTENTIONALLY LEFT BLANK

NOTE: SPECIFICATIONS AND PERFORMANCE DATA LISTED HEREIN ARE SUBJECT TO CHANGE WITHOUT NOTICE

Quality Makes the Difference!

All of our systems are designed and manufactured with the same high quality standards regardless of size or efficiency. We have designed these units to significantly reduce the most frequent causes of product failure. They are simple to service and forgiving to operate. We use quality materials and components. Finally, every unit is run tested before it leaves the factory. That's why we know. . . **There's No Better Quality."**

Visit our website at www.daikincomfort.com, www.goodmanmfg.com or www.amana-hac.com for information on:

- Products
- Warranties
- Customer Services
- Parts
- Contractor Programs and Training
- Financing Options

5151 San Felipe, Suite 500, Houston, TX 77056

© 2003-2007, 2009, 2012-2018 Goodman Manufacturing Company, L.P.

Amana is a registered trademark of Maytag Corporation or its related companies and is used under license. All rights reserved.