



# ENGINEERING DATA

**Inverter Split Unit Air Conditioner  
Wall Mounted  
Cooling Only & Heatpump [60Hz]**

**FTKF-A & FTXF-A Series**



**R32**

ED3WM22S-NA24V1



---

# Table of Contents

<b>Introduction</b> .....	<b>1</b>
Model Name and Power Supply .....	1
Nomenclature .....	2
<b>Functions</b> .....	<b>3</b>
<b>Specifications</b> .....	<b>4</b>
<b>Dimensions</b> .....	<b>10</b>
<b>Wiring Diagrams</b> .....	<b>12</b>
<b>Piping Diagrams</b> .....	<b>14</b>
<b>Capacity Tables</b> .....	<b>18</b>
Capacity Tables .....	18
Capacity Correction Factor .....	26
<b>Operation Limit</b> .....	<b>28</b>
<b>Sound Level</b> .....	<b>30</b>
Measuring Location .....	30
Sound Pressure Level & NC Curve .....	31
<b>Electric Characteristic</b> .....	<b>43</b>
<b>Accessories List</b> .....	<b>44</b>



# Introduction

## Model Name and Power Supply

Mode	Indoor Unit	Outdoor Unit	Power Supply
Cooling Only	FTKF09AXVJU	RKF09AXVJU	1Phase, 208/230V, 60Hz
	FTKF12AXVJU	RKF12AXVJU	
	FTKF18AXVJU	RKF18AXVJU	
	FTKF24AXVJU	RKF24AXVJU	
Heatpump	FTXF09AXVJU	RXF09AXVJU	
	FTXF12AXVJU	RXF12AXVJU	
	FTXF18AXVJU	RXF18AXVJU	
	FTXF24AXVJU	RXF24AXVJU	

## Nomenclature

### Indoor Unit

Definition	Description
Unit Category	<b>F</b> : Air-Cooled Split Indoor Unit
Product Type	<b>T</b> : Wall Mounted
System	<b>K</b> : Inverter, Cooling Only <b>X</b> : Inverter, Heatpump
Classification	<b>F</b> : R32, Standard
Capacity Indication*	<b>09</b> : 9,000 Btu/h
Major Design Category	<b>A</b> : A Series
Factory Origin	<b>X</b> : Malaysia
Power Supply	<b>VJ</b> : 208/230V / 1Phase / 60Hz
Country	<b>U</b> : United States

### Outdoor Unit

Definition	Description
Unit Category	<b>R</b> : Air-Cooled Split Outdoor Unit
System	<b>K</b> : Inverter, Cooling Only <b>X</b> : Inverter, Heatpump
Classification	<b>F</b> : R32, Standard
Capacity Indication*	<b>09</b> : 9,000 Btu/h
Major Design Category	<b>A</b> : A Series
Factory Origin	<b>X</b> : Malaysia
Power Supply	<b>VJ</b> : 208/230V / 1Phase / 60Hz
Country	<b>U</b> : United States

**Remark:**

\*Capacity value under Nomenclature is an indication.  
Please refer to Specifications for exact capacity value.

# Functions

Category	Functions	FTKF09/12A RKF09/12A	FTKF18/24A RKF18/24A	FTXF09/12A RXF09/12A	FTXF18/24A RXF18/24A
Basic Function	Inverter	●	●	●	●
	Operation Limit for Cooling (°CDB)(O/D)	10 ~ 48	10 ~ 50	10 ~ 48	10 ~ 50
	Operation Limit for Cooling (°FDB)(O/D)	50 ~ 118.4	50 ~ 122.0	50 ~ 118.4	50 ~ 122.0
	Operation Limit for Heating (°CWB)(O/D)	-	-	-15 ~ 18	-15 ~ 18
	Operation Limit for Heating (°FWB)(O/D)	-	-	5 ~ 64.4	5 ~ 64.4
Compressor	Scroll Compressor	-	-	-	-
	Rotary Compressor	-	-	-	-
	Swing Compressor	●	●	●	●
Comfortable Airflow	Power-airflow Flap	●	-	●	-
	Power-airflow Dual Flaps	-	●	-	●
	Power-airflow Diffuser	-	-	-	-
	Wide Angle Louvers	●	●	●	●
	Vertical Auto-Swing (Up and Down)	●	●	●	●
	Horizontal Auto-Swing (Right and Left)	-	-	-	-
	3D Airflow	-	-	-	-
Breeze Airflow	-	-	-	-	
Comfort Control	Auto Fan Speed	●	●	●	●
	Indoor Unit Quiet Operation	●	●	●	●
	Intelligent Eye Operation	-	-	-	-
	Automatic Defrosting	-	-	●	●
Operation	Automatic Operation	-	-	●	●
	Programme Dry Function	●	●	●	●
	Fan Only	●	●	●	●
Lifestyle Convenience	Powerful Operation (Non Inverter)	-	-	-	-
	Inverter Powerful Operation	●	●	●	●
	Energy Saving Function	●	●	●	●
	Sleep Mode	●	●	●	●
	Indoor Unit ON/OFF Button	●	●	●	●
	R/C with Backlight	●	●	●	●
	Signal Receiving Sign (R/C)	●	●	●	●
Set Temperature Display (R/C)	●	●	●	●	
Health & Clean	Saranet Filter	-	-	-	-
	GIN-ION Filter	-	-	-	-
	Catechin Filter / Green Tea Filter	●	●	●	●
	Titanium Apatite Air-Purifying Filter	●	●	●	●
	Enzyme Blue Deodorizing Filter	-	-	-	-
	PM 2.5 Filter	-	-	-	-
	Streamer	-	-	-	-
	Plasma	-	-	-	-
	Wipe Clean Flat Panel	●	●	●	●
Coil Clean (by APP control)	-	-	-	-	
Timer	Weekly Timer Operation (Wired R/C)	-	-	-	-
	24-hour ON/OFF Timer (R/C)	●	●	●	●
	Countdown ON/OFF Timer (R/C)	-	-	-	-
Worry Free (Reliability & Durability)	Auto Restart (after Power Failure)	●	●	●	●
	Self-diagnosis	●	●	●	●
	Anti-corrosion Treatment of Outdoor Heat Exchanger	Blue Fin	Blue Fin	Blue Fin	Blue Fin
	Low/High Voltage Shield (PCB Level / Unit Level)	-	-	-	-
Flexibility	Pre-charged Piping Length	32-13/16 ft	32-13/16 ft	32-13/16 ft	32-13/16 ft
	Either Side Drain (Right or Left)	●	●	●	●
	Detachable Drain Pan	●	●	●	●
	Low ambient cooling operation (-15°C) (5°F)	●	●	●	●
Remote Control	Wireless LAN Connectivity	●*	●*	●*	●*
	BAG Connectivity	●*	●*	●*	●*
	iTM Connectivity	-	-	-	-
	DIII-NET Connectivity	-	-	-	-
Remote Controller	Wireless	BRC52B64	BRC52B64	BRC52B63	BRC52B63
	Wired (Optional)	BRC51D61	BRC51D61	BRC51D61	BRC51D61

Note: ● : Available  
 - : Not Available  
 ●\* : Optional (Refer to DAMA Spare Part team for more details on optional items.)

# Specifications

## Cooling Only

MODEL	INDOOR UNIT		FTKF09A		FTKF12A		
	OUTDOOR UNIT		RKF09A		RKF12A		
Rated Capacity (Min. ~ Max.)	kW		2.64 (1.30 - 3.28)		3.52 (1.30 - 4.28)		
	Btu/h		9000 (4400 - 11200)		12000 (4400 - 14600)		
Moisture Removal	gal/h		0.05		0.16		
Rated Running Current	A		3.13		4.17		
Rated Power Consumption	W		720		960		
EER2	Btu/h/W				12.5		
SEER2					21.0		
Power Factor (Rated)			N/A				
Piping Connections	Liquid	inch (mm)			1/4" (6.35)		
	Gas	inch (mm)			3/8" (9.52)		
Refrigerant	Type		R32				
	Charge		lbs (kg)		1.65 (0.75)		
Max. Interunit Piping Length		ft (m)		65-5/8 (20)			
Max. Interunit Height Difference		ft (m)		49-1/4 (15)			
Chargeless		ft (m)		32-13/16 (10)			
Amount of Additional Charge of Refrigerant		oz/ft (g/m)		0.18 (17)			
Drawing No.		3D148846					
INDOOR UNIT			FTKF09A		FTKF12A		
Front Panel Colour			WHITE				
Airflow Rate	Turbo	CFM	466		473		
	High	CFM	431		436		
	Medium	CFM	322		316		
	Low	CFM	249		247		
	Quiet	CFM	142		132		
Sound Pressure Level (H/M/L/Q)		dBA		44/37/30/19		46/38/32/19	
Fan	Type		CROSS FLOW				
	Drive		DIRECT				
	Speed		3 STEPS, AUTO, QUIET, TURBO				
Fan Motor	Type		DIRECT CURRENT				
	Motor Output		W		22		
	Running Current (Rated)		A		0.10		
	Power Consumption (Rated)		W		29		
Air Direction Control			UP, DOWN, LEFT, RIGHT				
Air Filter			CATECHIN				
Dimensions (H x W x D)		inch (mm)		11-1/3 x 30-5/16 x 9-3/16 (288 x 770 x 234)			
Packaged Dimensions (H x W x D)		inch (mm)		12-3/8 x 32-11/16 x 14-1/16 (314 x 830 x 357)			
Weight		lbs (kg)		19.8 (9.0)		20.9 (9.5)	
Gross Weight		lbs (kg)		24.0 (10.9)		25.8 (11.7)	
Condensate Drain Size		inch (mm)		5/8 (16)			
Document No.		3D148845					
OUTDOOR UNIT			RKF09A		RKF12A		
Casing Colour			IVORY WHITE				
Airflow Rate	High	CFM			1051		
Sound Pressure Level		dBA		46		49	
Fan	Type		PROPELLER				
	Drive		DIRECT				
Fan Motor	Type		DIRECT CURRENT				
	Index of protection (IP)		24				
	Insulation Grade		E				
	Running Current (Rated)		A		0.61		
	Power Consumption (Rated)		W		46		
	Motor Output		W		26		
Poles		8					
Compressor	Type		HERMETIC SWING				
	Model		1Y091BKCX1A#G				
	Oil type		DAPHNE FW68DA				
	Oil amount		oz (cm <sup>3</sup> )		12.7 (375)		
Heat Exchanger Type			FIN TUBE				
Dimensions (H x W x D)		inch (mm)		21-11/16 x 26-1/2 x 11-3/16 (550 x 675 x 284)			
Packaged Dimensions (H x W x D)		inch (mm)		24-1/64 x 31-3/8 x 15-1/8 (610 x 801 x 384)			
Weight		lbs (kg)		60 (27)			
Gross Weight		lbs (kg)		66 (30)			
Document No.		3D148691					

1) ALL UNITS ARE BEING TESTED ACCORDING TO AHRI 210/240 STANDARD.

2) ALL SPECIFICATIONS ARE SUBJECT TO CHANGE BY THE MANUFACTURER WITHOUT PRIOR NOTICE.

COOLING	
INDOOR: 80°FDB (26.7°CDB) / 67°FWB (19.4°CWB)	
OUTDOOR: 95°FDB (35°CDB)	



MODEL	INDOOR UNIT		FTKF18A		FTKF24A	
	OUTDOOR UNIT		RKF18A		RKF24A	
Rated Capacity (Min. ~ Max.)	kW		5.30 (2.02 - 6.45)		6.57 (2.05 - 7.74)	
	Btu/h		18100 (6900 - 22000)		22400 (7000 - 26400)	
Moisture Removal	gal/h		0.61		0.88	
Rated Running Current	A		6.56		8.12	
Rated Power Consumption	W		1508		1867	
EER2	Btu/h/W				12.0	
SEER2					21.0	
Power Factor (Rated)					N/A	
Piping Connections	Liquid	inch (mm)			1/4" (6.35)	
	Gas	inch (mm)	1/2" (12.70)		5/8" (15.88)	
Refrigerant	Type				R32	
	Charge	lbs (kg)			3.31 (1.50)	
Max. Interunit Piping Length	ft (m)				98-1/2 (30)	
Max. Interunit Height Difference	ft (m)				65-5/8 (20)	
Chargeless	ft (m)				32-13/16 (10)	
Amount of Additional Charge of Refrigerant	oz/ft (g/m)				0.18 (17)	
Drawing No.					3D148846	
INDOOR UNIT			FTKF18A		FTKF24A	
Front Panel Colour					WHITE	
Airflow Rate	Turbo	CFM			754	
	High	CFM			716	
	Medium	CFM			605	
	Low	CFM			467	
	Quiet	CFM			395	
Sound Pressure Level (H/M/L/Q)	dBA		49/44/38/33		53/45/39/34	
Fan	Type				CROSS FLOW	
	Drive				DIRECT	
	Speed				3 STEPS, AUTO, QUIET, TURBO	
Fan Motor	Type				DIRECT CURRENT	
	Motor Output	W			39	
	Running Current (Rated)	A			0.17	
	Power Consumption (Rated)	W			54	
Air Direction Control					UP, DOWN, LEFT, RIGHT	
Air Filter					CATECHIN	
Dimensions (H x W x D)	inch (mm)				11-11/16 x 39-9/16 x 10-3/4 (297 x 990 x 273)	
Packaged Dimensions (H x W x D)	inch (mm)				14-3/4 x 14-5/8 x 42-1/4 (375 x 371 x 1073)	
Weight	lbs (kg)				30.5 (13.8)	
Gross Weight	lbs (kg)				36 (16.5)	
Condensate Drain Size	inch (mm)				5/8 (16)	
Document No.					3D148845	
OUTDOOR UNIT			RKF18A		RKF24A	
Casing Colour					IVORY WHITE	
Airflow Rate	High	CFM			1879	
Sound Pressure Level	dBA		54		55	
Fan	Type				PROPELLER	
	Drive				DIRECT	
Fan Motor	Type				DIRECT CURRENT	
	Index of protection (IP)				23	
	Insulation Grade				E	
	Running Current (Rated)	A			1.30	
	Power Consumption (Rated)	W	85		88	
	Motor Output	W			55	
	Poles				8	
Compressor	Type				HERMETIC SWING	
	Model				2Y147BKBX1A#A	
	Oil type				DAPHNE FW68DA	
	Oil amount	oz (cm <sup>3</sup> )			22.0 (650)	
Heat Exchanger Type					FIN TUBE	
Dimensions (H x W x D)	inch (mm)				27-13/32 x 36-5/8 x 13-13/16 (696 x 930 x 351)	
Packaged Dimensions (H x W x D)	inch (mm)				29-7/8 x 42-3/8 x 18-7/8 (760 x 1075 x 480)	
Weight	lbs (kg)				101 (46)	
Gross Weight	lbs (kg)				110 (50)	
Document No.					3D148691	

1) ALL UNITS ARE BEING TESTED ACCORDING TO AHRI 210/240 STANDARD.  
 2) ALL SPECIFICATIONS ARE SUBJECT TO CHANGE BY THE MANUFACTURER WITHOUT PRIOR NOTICE.

COOLING	
INDOOR: 80°FDB (26.7°CDB) / 67°FWB (19.4°CWB)	
OUTDOOR: 95°FDB (35°CDB)	

## Heatpump

MODEL	INDOOR UNIT		FTXF09A	
	OUTDOOR UNIT		RXF09A	
			Cooling	Heating
Rated Capacity (Min. ~ Max.)		kW	2.64 (1.30 - 3.28)	2.93 (1.30 - 4.19)
		Btu/h	9000 (4400 - 11200)	10000 (4400 - 14300)
Moisture Removal		gal/h	0.05	
Rated Running Current		A	3.13	3.13
Rated Power Consumption		W	720	719
EER2		Btu/h/W	12.5	N/A
SEER2			21.0	N/A
COP		W/W	N/A	4.06
HSPF2			N/A	10.2
Power Factor (Rated)			N/A	
Piping Connections	Liquid	inch (mm)	1/4" (6.35)	
	Gas	inch (mm)	3/8" (9.52)	
Refrigerant	Type		R32	
	Charge	lbs (kg)	1.65 (0.75)	
Max. Interunit Piping Length		ft (m)	65-5/8 (20)	
Max. Interunit Height Difference		ft (m)	49-1/4 (15)	
Chargeless		ft (m)	32-13/16 (10)	
Amount of Additional Charge of Refrigerant		oz/ft (g/m)	0.18 (17)	
Drawing No.			3D148846	
			FTXF09A	
Front Panel Colour			WHITE	
Airflow Rate	Turbo	CFM	466	
	High	CFM	431	402
	Medium	CFM	322	
	Low	CFM	249	
Sound Pressure Level (H/M/L/Q)	Quiet	CFM	142	219
		dBA	44/37/30/19	43/36/30/25
Fan	Type		CROSS FLOW	
	Drive		DIRECT	
	Speed		3 STEPS, AUTO, QUIET, TURBO	
Fan Motor	Type		DIRECT CURRENT	
	Motor Output	W	22	
	Running Current (Rated)	A	0.10	
	Power Consumption (Rated)	W	29	
Air Direction Control			UP, DOWN, LEFT, RIGHT	
Air Filter			CATECHIN	
Dimensions (H x W x D)		inch (mm)	11-1/3 x 30-5/16 x 9-3/16 (288 x 770 x 234)	
Packaged Dimensions (H x W x D)		inch (mm)	12-3/8 x 32-11/16 x 14-1/16 (314 x 830 x 357)	
Weight		lbs (kg)	19.8 (9.0)	
Gross Weight		lbs (kg)	24.0 (10.9)	
Condensate Drain Size		inch (mm)	5/8 (16)	
Document No.			3D148845	
			RXF09A	
Casing Colour			IVORY WHITE	
Airflow Rate	High	CFM	1051	966
Sound Pressure Level		dBA	46	48
Fan	Type		PROPELLER	
	Drive		DIRECT	
Fan Motor	Type		DIRECT CURRENT	
	Index of protection (IP)		24	
	Insulation Grade		E	
	Running Current (Rated)	A	0.61	
	Power Consumption (Rated)	W	46	
	Motor Output	W	26	
Compressor	Poles		8	
	Type		HERMETIC SWING	
	Model		1Y091BKCX1A#G	
	Oil type		DAPHNE FW68DA	
	Oil amount	oz (cm <sup>3</sup> )	12.7 (375)	
Heat Exchanger Type			FIN TUBE	
Dimensions (H x W x D)		inch (mm)	21-11/16 x 26-1/2 x 11-3/16 (550 x 675 x 284)	
Packaged Dimensions (H x W x D)		inch (mm)	24-1/64 x 31-3/8 x 15-1/8 (610 x 801 x 384)	
Weight		lbs (kg)	60 (27)	
Gross Weight		lbs (kg)	66 (30)	
Document No.			3D148691	

1) ALL UNITS ARE BEING TESTED ACCORDING TO AHRI 210/240 STANDARD.

2) ALL SPECIFICATIONS ARE SUBJECT TO CHANGE BY THE MANUFACTURER WITHOUT PRIOR NOTICE.

COOLING		HEATING	
INDOOR: 80°FDB (26.7°CDB) / 67°F WB (19.4°CWB)		INDOOR: 70°FDB (21.1°CDB)	
OUTDOOR: 95°FDB (35°CDB)		OUTDOOR: 47°FDB (8.3°CDB) / 43°F WB (6.1°CWB)	

MODEL	INDOOR UNIT		FTXF12A	
	OUTDOOR UNIT		RXF12A	
			Cooling	Heating
Rated Capacity (Min. ~ Max.)		kW	3.52 (1.30 - 4.28)	3.96 (1.30 - 5.28)
		Btu/h	12000 (4400 - 14600)	13500 (4400 - 18000)
Moisture Removal		gal/h	0.16	
Rated Running Current		A	4.17	4.52
Rated Power Consumption		W	960	1038
EER2		Btu/h/W	12.5	N/A
SEER2			21.0	N/A
COP		W/W	N/A	3.8
HSPF2			N/A	10.2
Power Factor (Rated)			N/A	
Piping Connections	Liquid	inch (mm)	1/4" (6.35)	
	Gas	inch (mm)	3/8" (9.52)	
Refrigerant	Type		R32	
	Charge	lbs (kg)	1.65 (0.75)	
Max. Interunit Piping Length		ft (m)	65-5/8 (20)	
Max. Interunit Height Difference		ft (m)	49-1/4 (15)	
Chargeless		ft (m)	32-13/16 (10)	
Amount of Additional Charge of Refrigerant		oz/ft (g/m)	0.18 (17)	
Drawing No.			3D148846	
INDOOR UNIT		FTXF12A		
Front Panel Colour		WHITE		
Airflow Rate	Turbo	CFM	473	
	High	CFM	436	412
	Medium	CFM	316	
	Low	CFM	247	
	Quiet	CFM	132	210
Sound Pressure Level (H/M/L/Q)		dBA	46/38/32/19	45/37/31/26
Fan	Type	CROSS FLOW		
	Drive	DIRECT		
	Speed	3 STEPS, AUTO, QUIET, TURBO		
Fan Motor	Type	DIRECT CURRENT		
	Motor Output	W	22	
	Running Current (Rated)	A	0.10	
	Power Consumption (Rated)	W	29	
Air Direction Control		UP, DOWN, LEFT, RIGHT		
Air Filter		CATECHIN		
Dimensions (H x W x D)		inch (mm)	11-1/3 x 30-5/16 x 9-3/16 (288 x 770 x 234)	
Packaged Dimensions (H x W x D)		inch (mm)	12-3/8 x 32-11/16 x 14-1/16 (314 x 830 x 357)	
Weight		lbs (kg)	20.9 (9.5)	
Gross Weight		lbs (kg)	25.8 (11.7)	
Condensate Drain Size		inch (mm)	5/8 (16)	
Document No.			3D148845	
OUTDOOR UNIT		RXF12A		
Casing Colour		IVORY WHITE		
Airflow Rate	High	CFM	1051	966
Sound Pressure Level		dBA	48	
Fan	Type	PROPELLER		
	Drive	DIRECT		
Fan Motor	Type	DIRECT CURRENT		
	Index of protection (IP)	24		
	Insulation Grade	E		
	Running Current (Rated)	A	0.61	
	Power Consumption (Rated)	W	46	
	Motor Output	W	26	
Compressor	Poles	8		
	Type	HERMETIC SWING		
	Model	1Y091BKCX1A#G		
	Oil type	DAPHNE FW68DA		
	Oil amount	oz (cm <sup>3</sup> )	12.7 (375)	
Heat Exchanger Type		FIN TUBE		
Dimensions (H x W x D)		inch (mm)	21-11/16 x 26-1/2 x 11-3/16 (550 x 675 x 284)	
Packaged Dimensions (H x W x D)		inch (mm)	24-1/64 x 31-3/8 x 15-1/8 (610 x 801 x 384)	
Weight		lbs (kg)	60 (27)	
Gross Weight		lbs (kg)	66 (30)	
Document No.			3D148691	

1) ALL UNITS ARE BEING TESTED ACCORDING TO AHRI 210/240 STANDARD.  
 2) ALL SPECIFICATIONS ARE SUBJECTED TO CHANGE BY THE MANUFACTURER WITHOUT PRIOR NOTICE.

COOLING		HEATING	
INDOOR: 80°FDB (26.7°CDB) / 67°FWB (19.4°CWB)		INDOOR: 70°FDB (21.1°CDB)	
OUTDOOR: 95°FDB (35°CDB)		OUTDOOR: 47°FDB (8.3°CDB) / 43°FWB (6.1°CWB)	

Specifications

MODEL	INDOOR UNIT		FTXF18A	
	OUTDOOR UNIT		RXF18A	
			Cooling	Heating
Rated Capacity (Min. ~ Max.)		kW	5.30 (2.02 - 6.45)	6.33 (1.70 - 7.74)
		Btu/h	18100 (6900 - 22000)	21600 (5800 - 26400)
Moisture Removal		gal/h	0.61	
Rated Running Current		A	6.56	7.64
Rated Power Consumption		W	1508	1756
EER2		Btu/h/W	12.0	N/A
SEER2			21.0	N/A
COP		W/W	N/A	3.60
HSPF2			N/A	9.60
Power Factor (Rated)			N/A	
Piping Connections	Liquid	inch (mm)	1/4" (6.35)	
	Gas	inch (mm)	1/2" (12.70)	
Refrigerant	Type		R32	
	Charge	lbs (kg)	3.31 (1.50)	
Max. Interunit Piping Length		ft (m)	98-1/2 (30)	
Max. Interunit Height Difference		ft (m)	65-5/8 (20)	
Chargeless		ft (m)	32-13/16 (10)	
Amount of Additional Charge of Refrigerant		oz/ft (g/m)	0.18 (17)	
Drawing No.			3D148846	
INDOOR UNIT		FTXF18A		
Front Panel Colour		WHITE		
Airflow Rate	Turbo	CFM	754	
	High	CFM	716	
	Medium	CFM	605	
	Low	CFM	467	
	Quiet	CFM	395	
Sound Pressure Level (H/M/L/Q)		dBA	49/44/38/33	49/42/37/33
Fan	Type	CROSS FLOW		
	Drive	DIRECT		
	Speed	3 STEPS, AUTO, QUIET, TURBO		
Fan Motor	Type	DIRECT CURRENT		
	Motor Output	W	39	
	Running Current (Rated)	A	0.17	
	Power Consumption (Rated)	W	54	
Air Direction Control		UP, DOWN, LEFT, RIGHT		
Air Filter		CATECHIN		
Dimensions (H x W x D)		inch (mm)	11-11/16 x 39-9/16 x 10-3/4 (297 x 990 x 273)	
Packaged Dimensions (H x W x D)		inch (mm)	14-3/4 x 14-5/8 x 42-1/4 (375 x 371 x 1073)	
Weight		lbs (kg)	30.5 (13.8)	
Gross Weight		lbs (kg)	36 (16.5)	
Condensate Drain Size		inch (mm)	5/8 (16)	
Document No.			3D148845	
OUTDOOR UNIT		RXF18A		
Casing Colour		IVORY WHITE		
Airflow Rate	High	CFM	1879	1833
Sound Pressure Level		dBA	54	
Fan	Type	PROPELLER		
	Drive	DIRECT		
Fan Motor	Type	DIRECT CURRENT		
	Index of protection (IP)	23		
	Insulation Grade	E		
	Running Current (Rated)	A	1.30	
	Power Consumption (Rated)	W	85	
	Motor Output	W	55	
Compressor	Poles	8		
	Type	HERMETIC SWING		
	Model	2Y147BKBX1A#A		
	Oil type	DAPHNE FW68DA		
	Oil amount	oz (cm <sup>3</sup> )	22.0 (650)	
Heat Exchanger Type		FIN TUBE		
Dimensions (H x W x D)		inch (mm)	27-13/32 x 36-5/8 x 13-13/16 (696 x 930 x 351)	
Packaged Dimensions (H x W x D)		inch (mm)	29-7/8 x 42-3/8 x 18-7/8 (760 x 1075 x 480)	
Weight		lbs (kg)	101 (46)	
Gross Weight		lbs (kg)	110 (50)	
Document No.			3D148691	

1) ALL UNITS ARE BEING TESTED ACCORDING TO AHRI 210/240 STANDARD.  
 2) ALL SPECIFICATIONS ARE SUBJECTED TO CHANGE BY THE MANUFACTURER WITHOUT PRIOR NOTICE.

COOLING		HEATING	
INDOOR: 80°FDB (26.7°CDB) / 67°FWB (19.4°CWB)		INDOOR: 70°FDB (21.1°CDB)	
OUTDOOR: 95°FDB (35°CDB)		OUTDOOR: 47°FDB (8.3°CDB) / 43°FWB (6.1°CWB)	

MODEL	INDOOR UNIT		FTXF24A	
	OUTDOOR UNIT		RXF24A	
			Cooling	Heating
Rated Capacity (Min. ~ Max.)	kW		6.57 (2.05 - 7.74)	6.92 (1.82 - 8.38)
	Btu/h		22400 (7000 - 26400)	23600 (6200 - 28600)
Moisture Removal	gal/h		0.88	
Rated Running Current	A		8.12	9.0
Rated Power Consumption	W		1867	2070
EER2	Btu/h/W		12.0	N/A
SEER2			21.0	N/A
COP	W/W		N/A	3.34
HSPF2			N/A	9.10
Power Factor (Rated)		N/A		
Piping Connections	Liquid	inch (mm)	1/4" (6.35)	
	Gas	inch (mm)	5/8" (15.88)	
Refrigerant	Type		R32	
	Charge		lbs (kg)	
Max. Interunit Piping Length	ft (m)		98-1/2 (30)	
Max. Interunit Height Difference	ft (m)		65-5/8 (20)	
Chargeless	ft (m)		32-13/16 (10)	
Amount of Additional Charge of Refrigerant	oz/ft (g/m)		0.18 (17)	
Drawing No.			3D148846	
INDOOR UNIT		FTXF24A		
Front Panel Colour		WHITE		
Airflow Rate	Turbo	CFM	754	
	High	CFM	716	
	Medium	CFM	605	
	Low	CFM	467	
	Quiet	CFM	395	
Sound Pressure Level (H/M/L/Q)	dBA		53/45/39/34	53/43/38/34
Fan	Type		CROSS FLOW	
	Drive		DIRECT	
	Speed		3 STEPS, AUTO, QUIET, TURBO	
Fan Motor	Type		DIRECT CURRENT	
	Motor Output	W	39	
	Running Current (Rated)	A	0.17	
	Power Consumption (Rated)	W	54	
Air Direction Control		UP, DOWN, LEFT, RIGHT		
Air Filter		CATECHIN		
Dimensions (H x W x D)	inch (mm)		11-11/16 x 39-9/16 x 10-3/4 (297 x 990 x 273)	
Packaged Dimensions (H x W x D)	inch (mm)		14-3/4 x 14-5/8 x 42-1/4 (375 x 371 x 1073)	
Weight	lbs (kg)		30.5 (13.8)	
Gross Weight	lbs (kg)		36 (16.5)	
Condensate Drain Size	inch (mm)		5/8 (16)	
Document No.			3D148845	
OUTDOOR UNIT		RXF24A		
Casing Colour		IVORY WHITE		
Airflow Rate	High	CFM	1879	1833
Sound Pressure Level	dBA		55	
Fan	Type		PROPELLER	
	Drive		DIRECT	
Fan Motor	Type		DIRECT CURRENT	
	Index of protection (IP)		23	
	Insulation Grade		E	
	Running Current (Rated)	A	1.30	
	Power Consumption (Rated)	W	88	
	Motor Output	W	55	
Compressor	Poles		8	
	Type		HERMETIC SWING	
	Model		2Y147BKBX1A#A	
	Oil type		DAPHNE FW68DA	
	Oil amount	oz (cm <sup>3</sup> )	22.0 (650)	
Heat Exchanger Type		FIN TUBE		
Dimensions (H x W x D)	inch (mm)		27-13/32 x 36-5/8 x 13-13/16 (696 x 930 x 351)	
Packaged Dimensions (H x W x D)	inch (mm)		29-7/8 x 42-3/8 x 18-7/8 (760 x 1075 x 480)	
Weight	lbs (kg)		101 (46)	
Gross Weight	lbs (kg)		110 (50)	
Document No.			3D148691	

1) ALL UNITS ARE BEING TESTED ACCORDING TO AHRI 210/240 STANDARD.  
 2) ALL SPECIFICATIONS ARE SUBJECTED TO CHANGE BY THE MANUFACTURER WITHOUT PRIOR NOTICE.

COOLING		HEATING	
INDOOR: 80°FDB (26.7°CDB) / 67°F WB (19.4°CWB)		INDOOR: 70°FDB (21.1°CDB)	
OUTDOOR: 95°FDB (35°CDB)		OUTDOOR: 47°FDB (8.3°CDB) / 43°F WB (6.1°CWB)	

# Dimensions

## Indoor Unit

Model : FTKF09/12A, FTXF09/12A

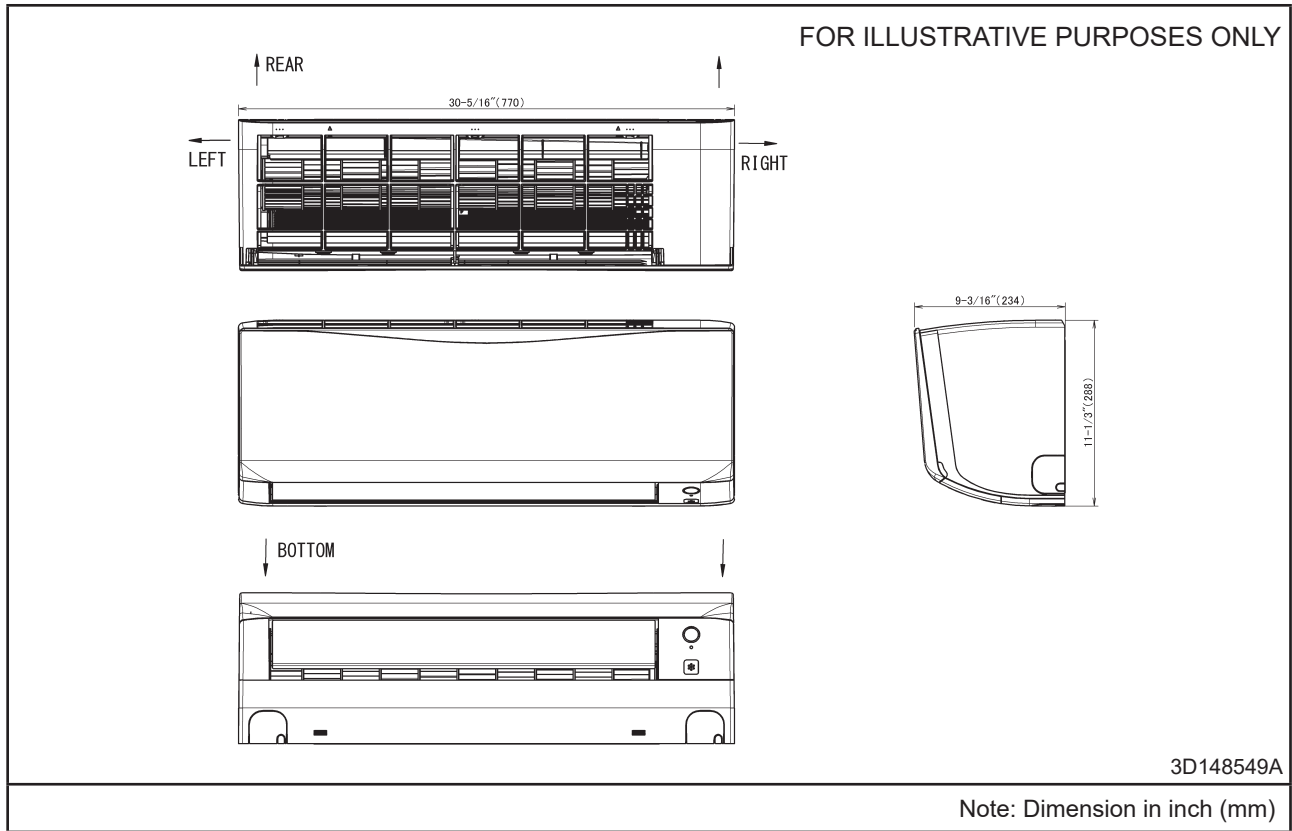

Model : FTKF18/24A, FTXF18/24A

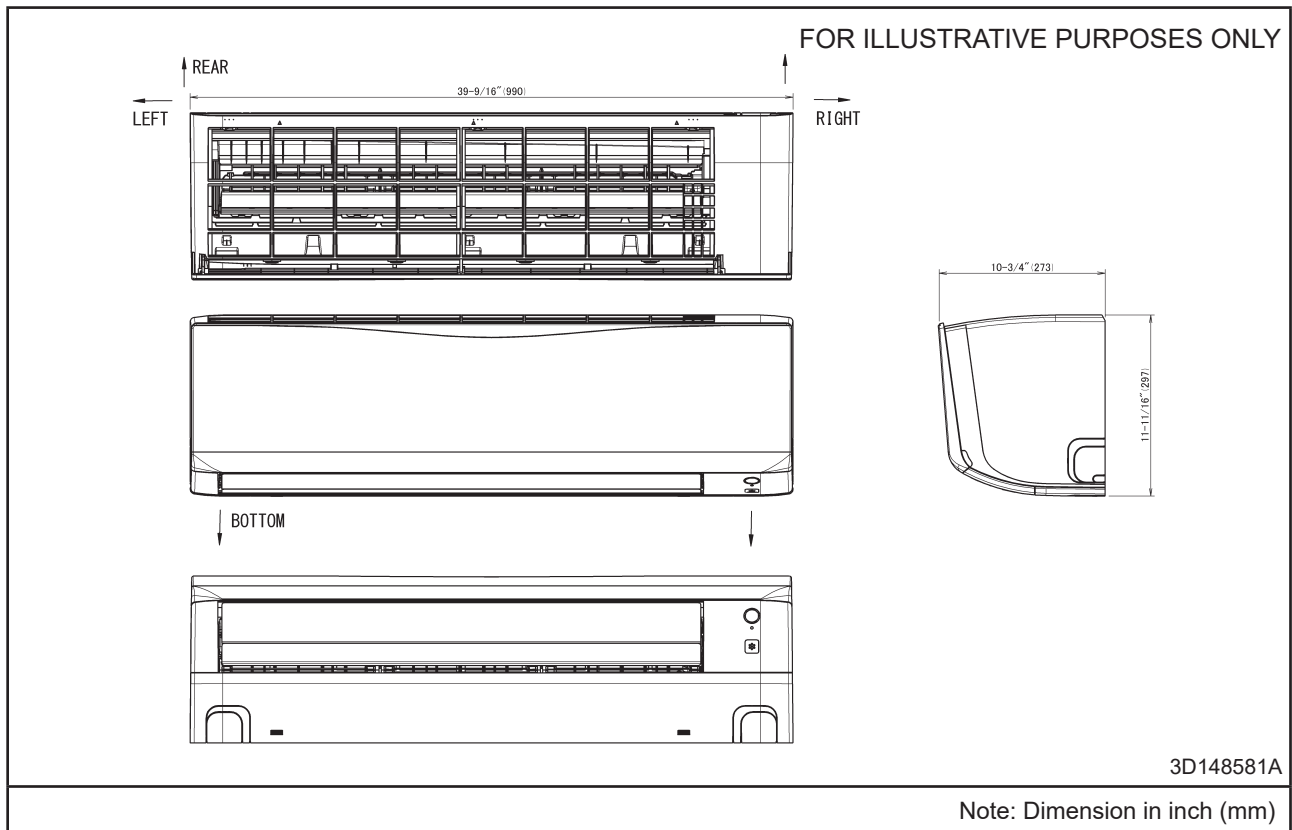

## Outdoor Unit

Model : RKF09/12A, RXF09/12A

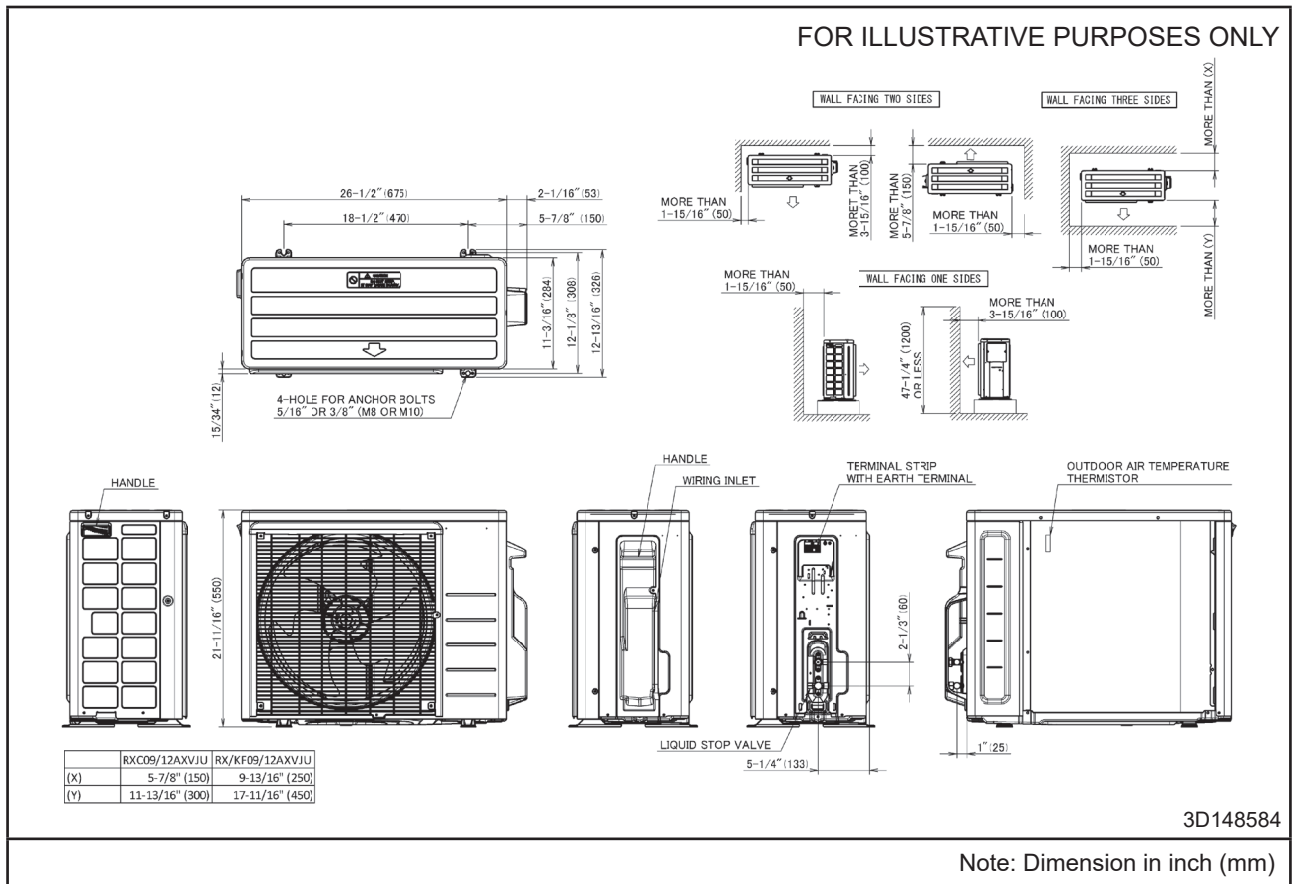

Model : RKF18/24A, RXF18/24A

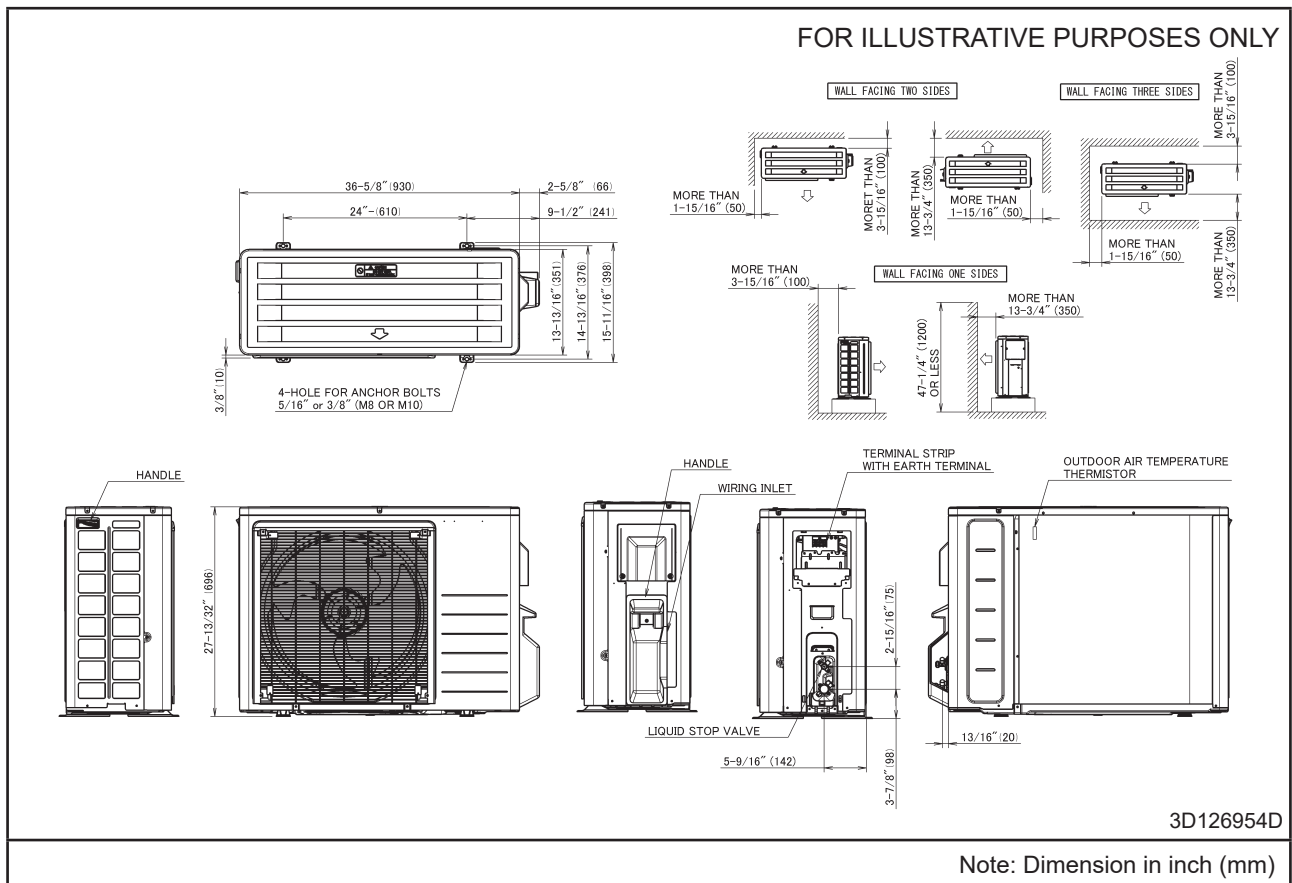

# Wiring Diagrams

## Indoor Unit

Model : FTKF-A, FTXF-A

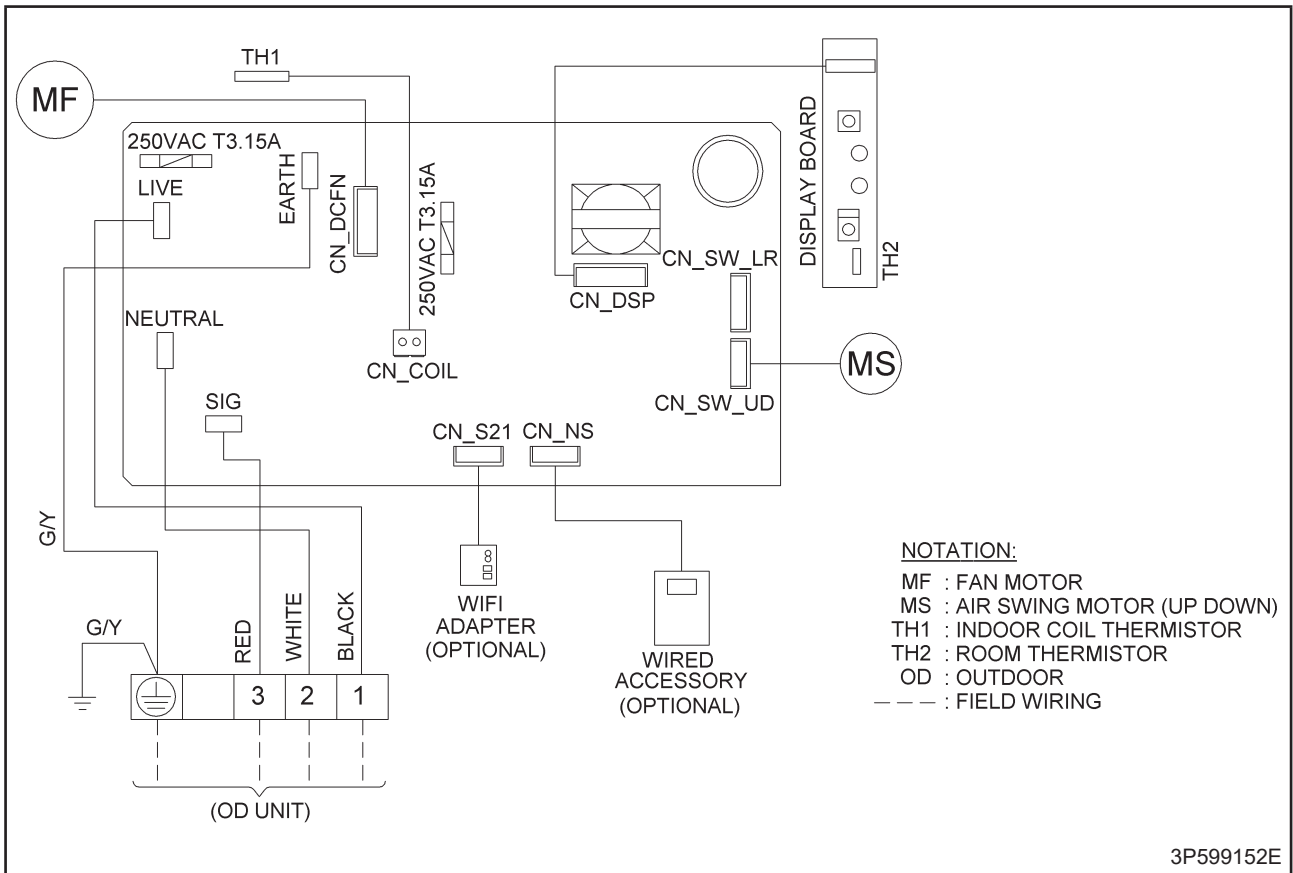



## Outdoor Unit

Model : RKF09/12A, RXF09/12A

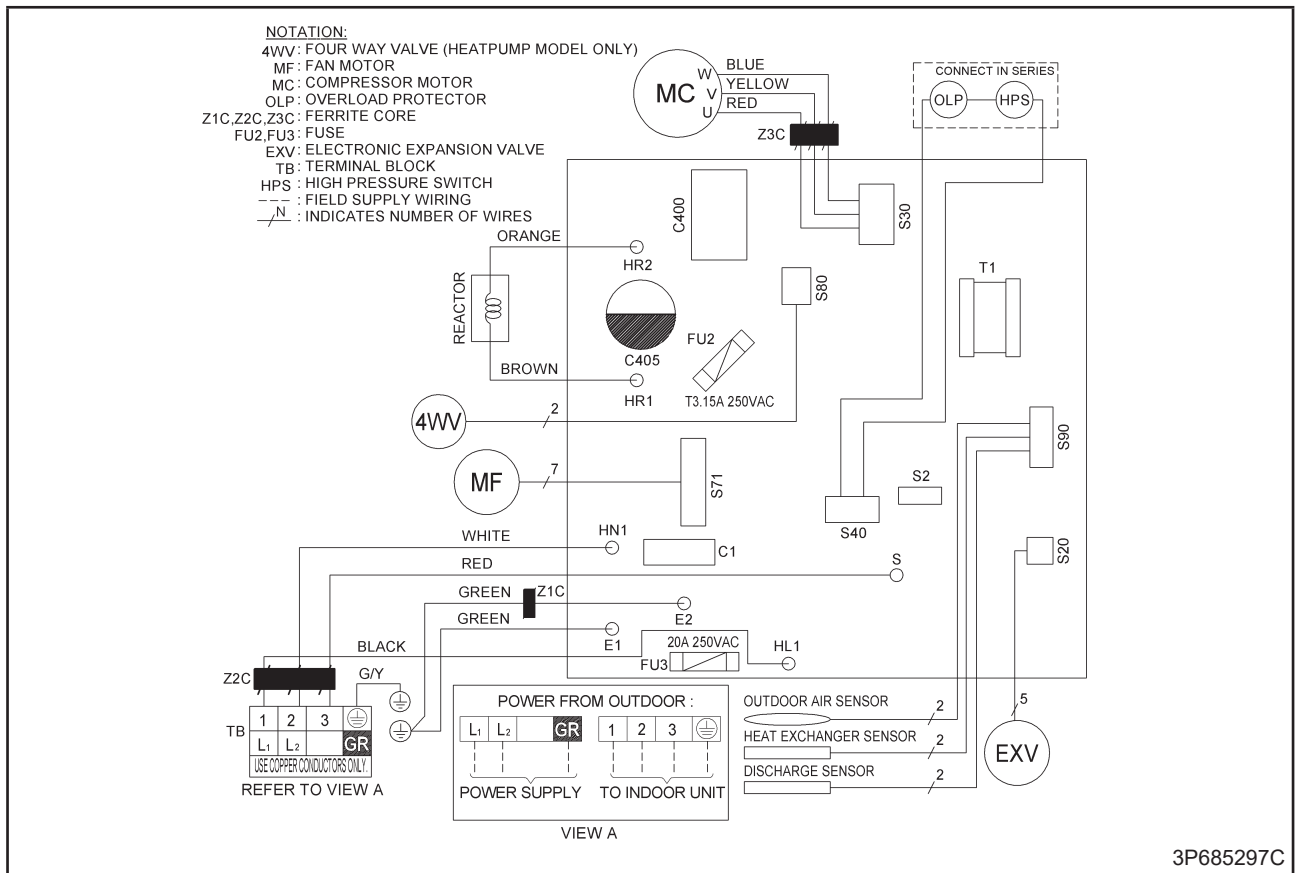

Model : RKF18/24A, RXF18/24A

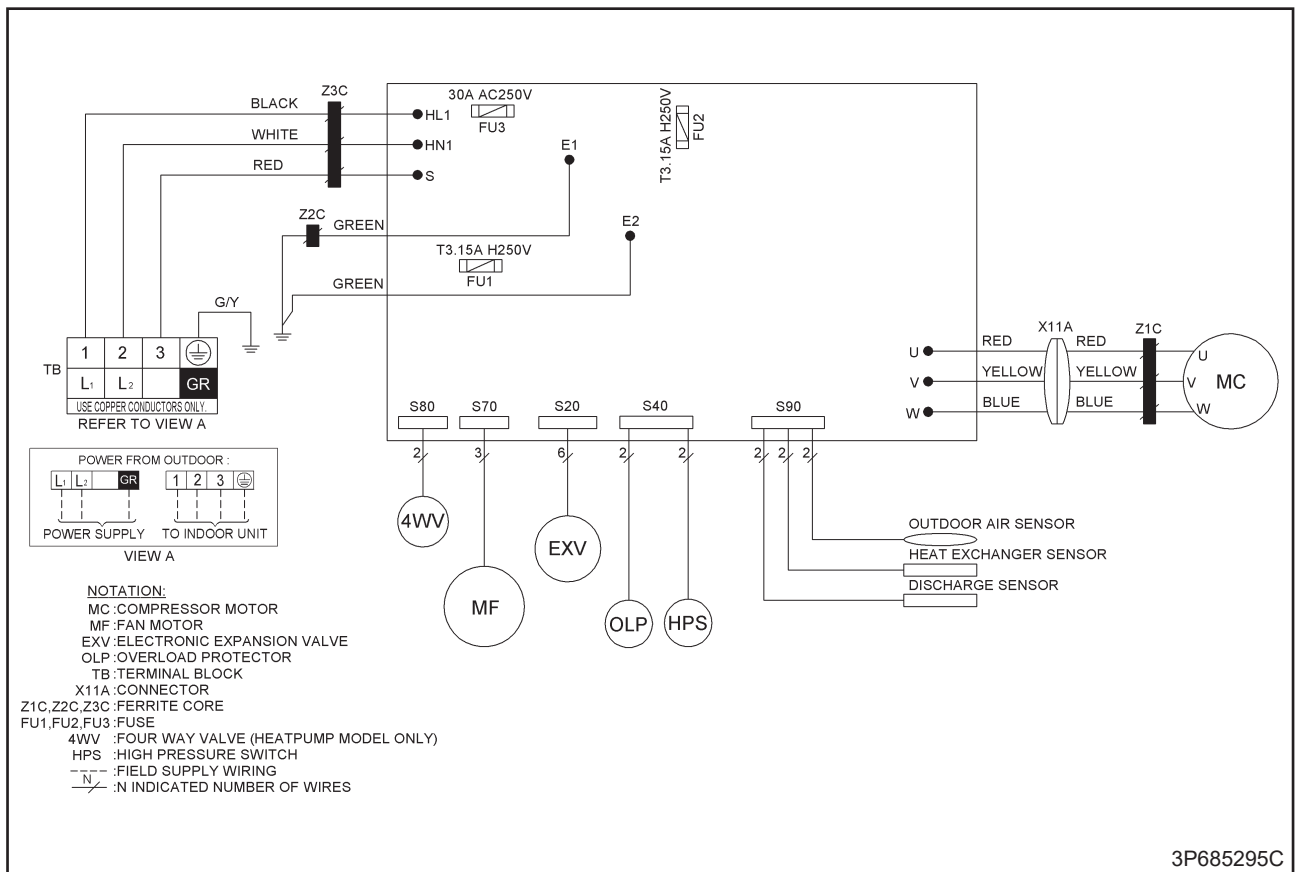

# Piping Diagrams

## Indoor Unit

Model : FTKF09A, FTXF09A

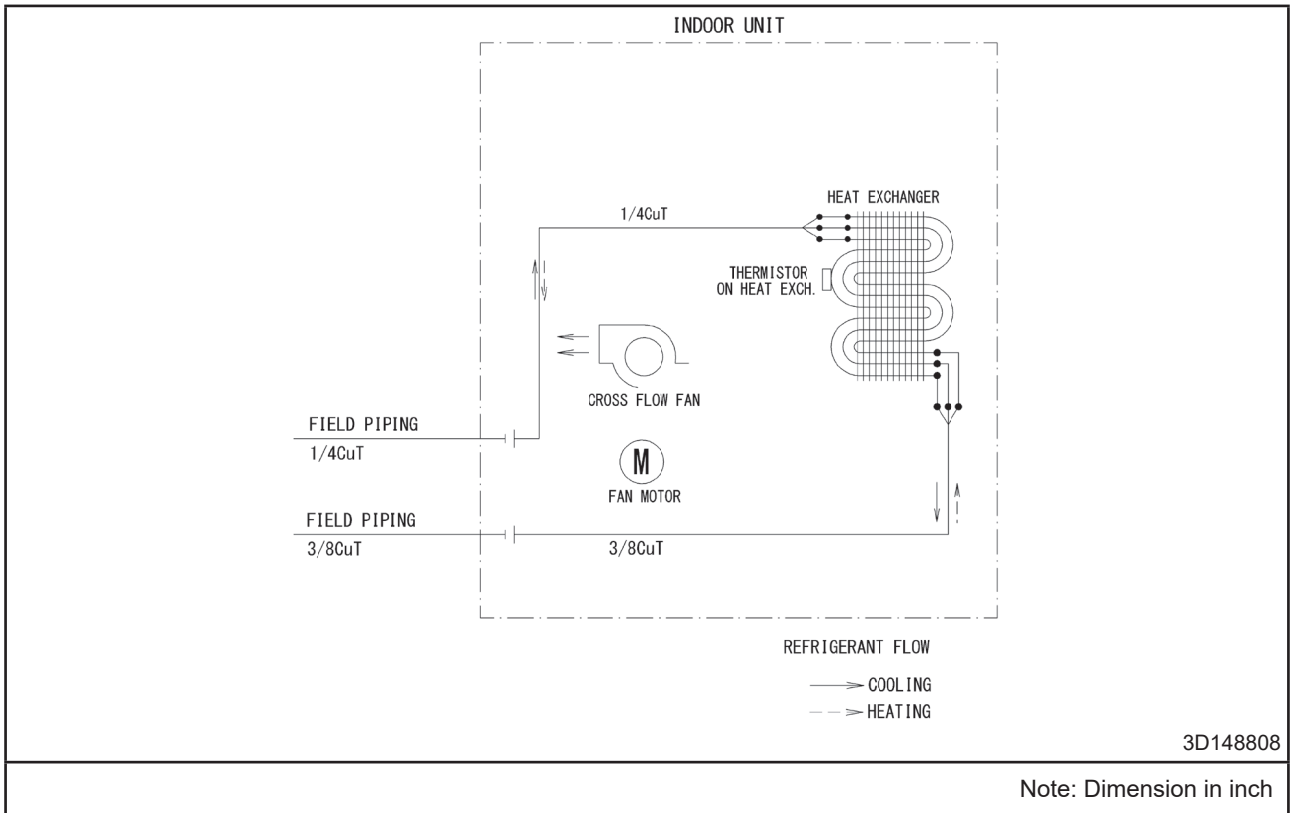

Model : FTKF12A, FTXF12A

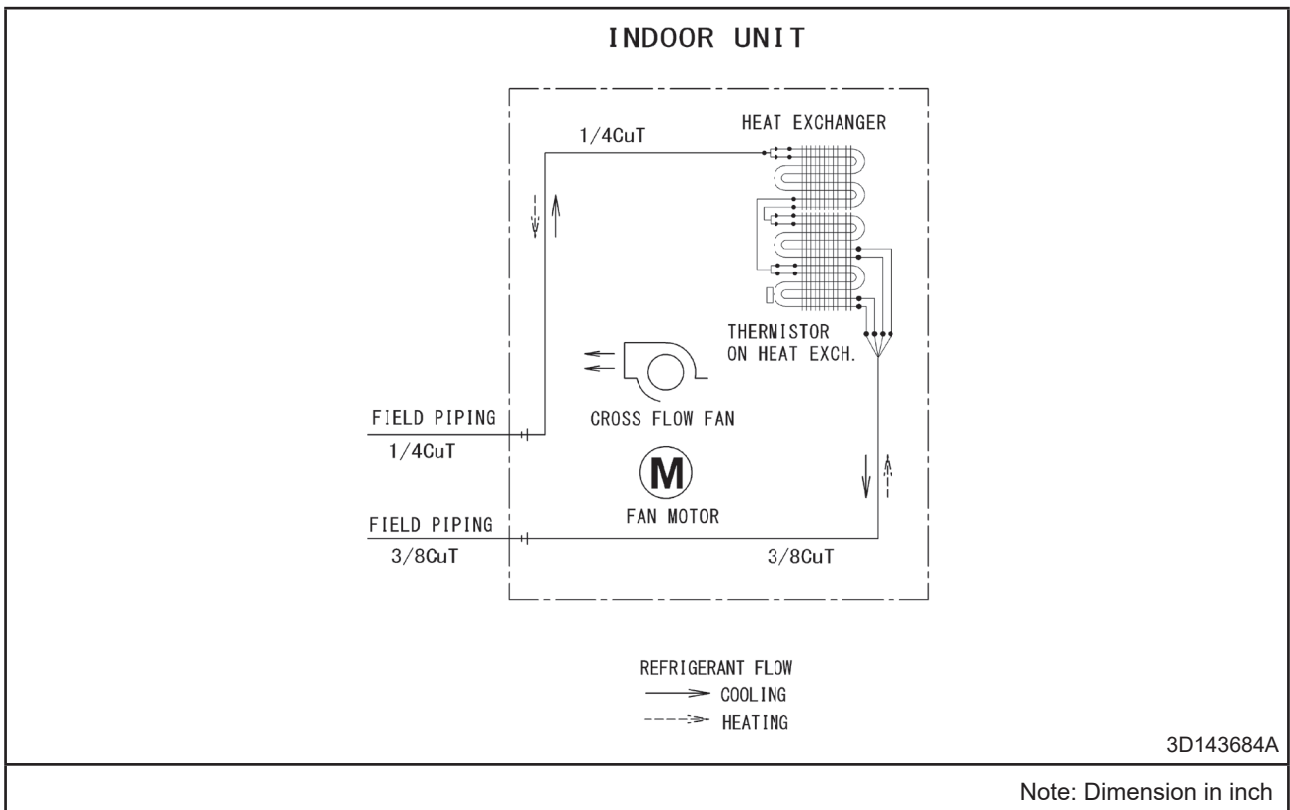

Model : FTKF18A, FTXF18A

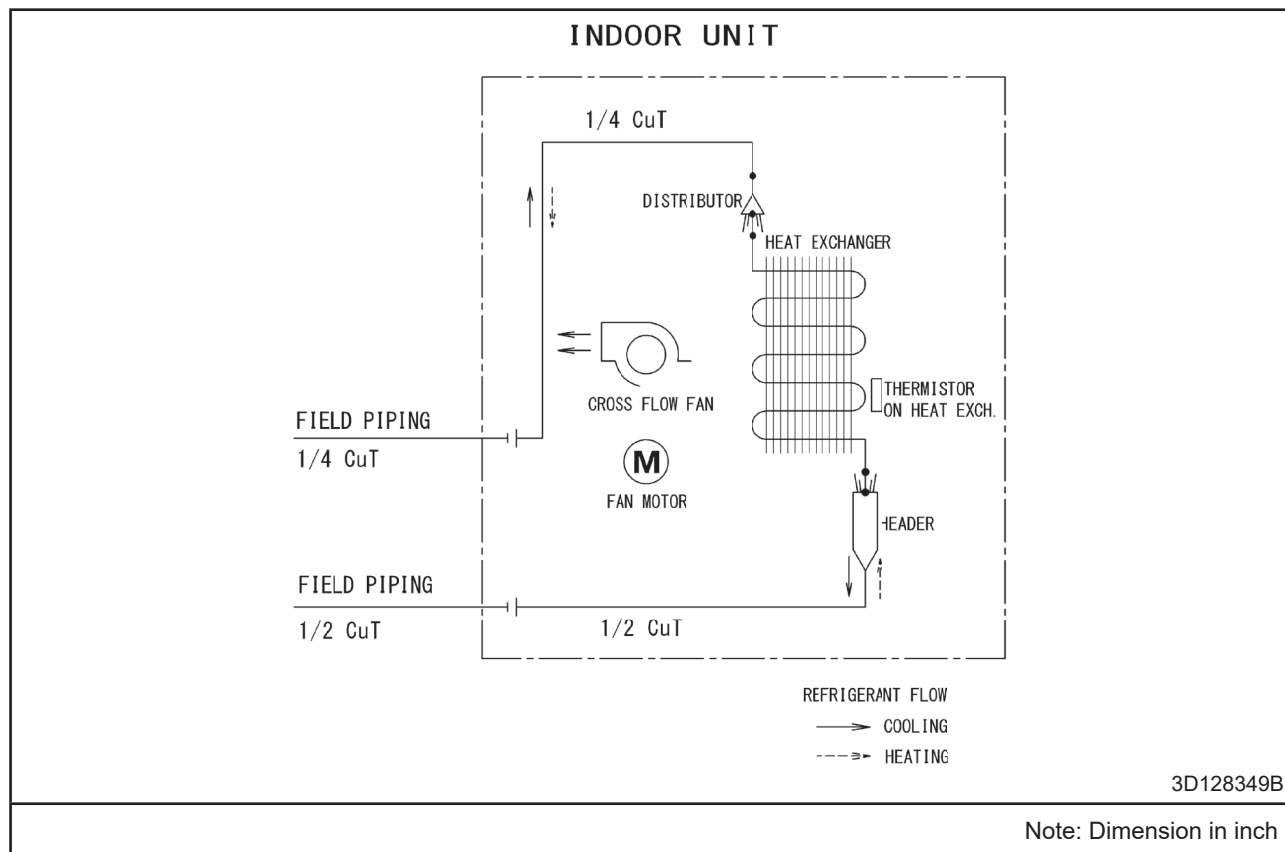

Model : FTKF24A, FTXF24A

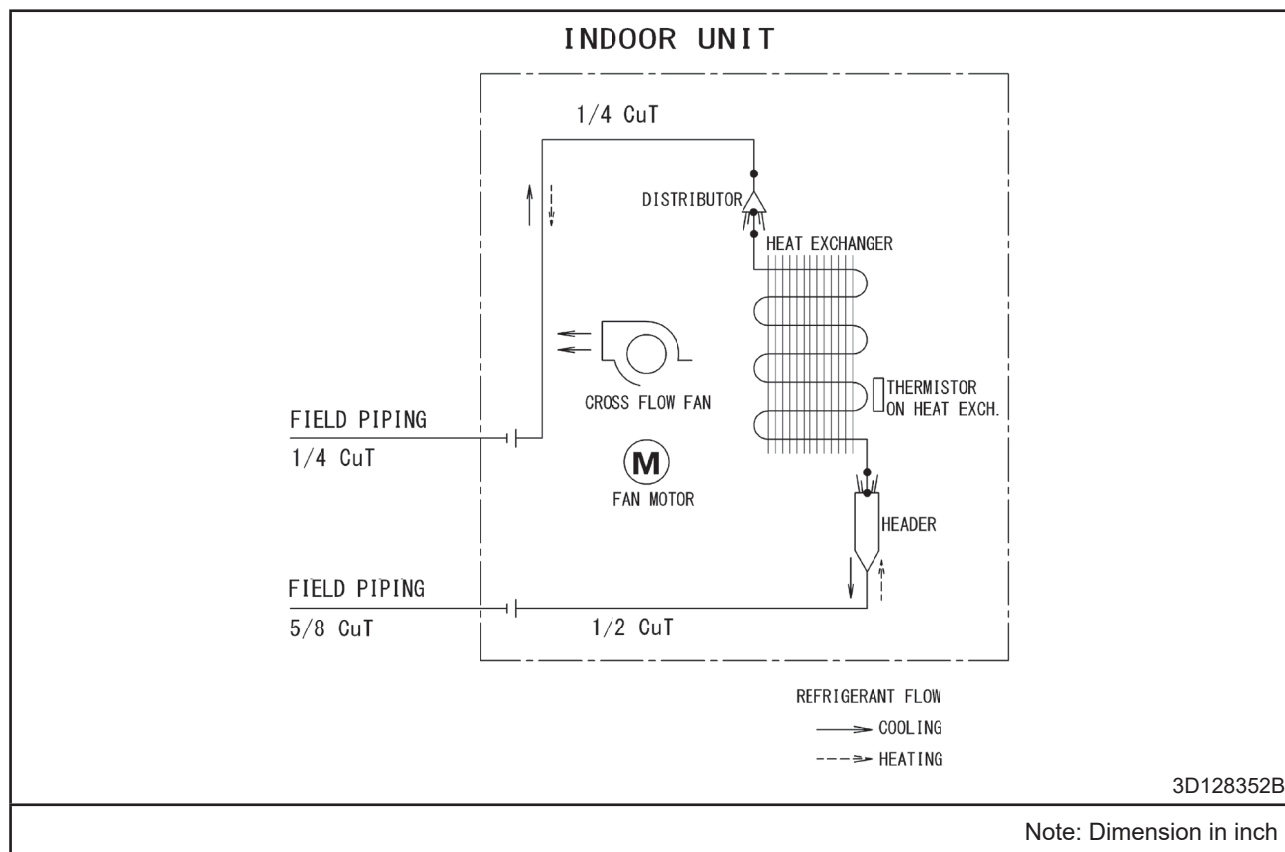

# Outdoor Unit

## Cooling Only

Model : RKF09/12A, RXF09/12A

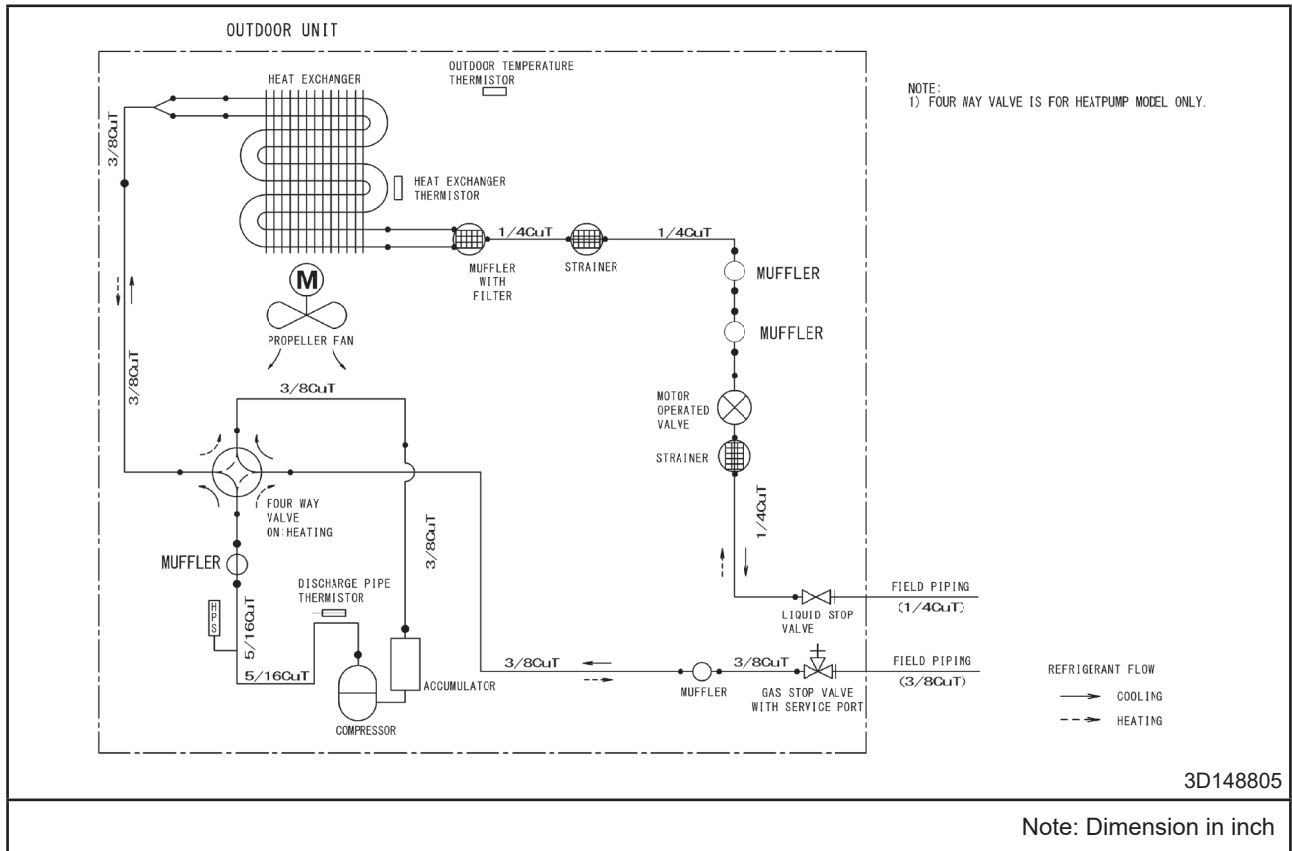

Model : RKF18A, RXF18A

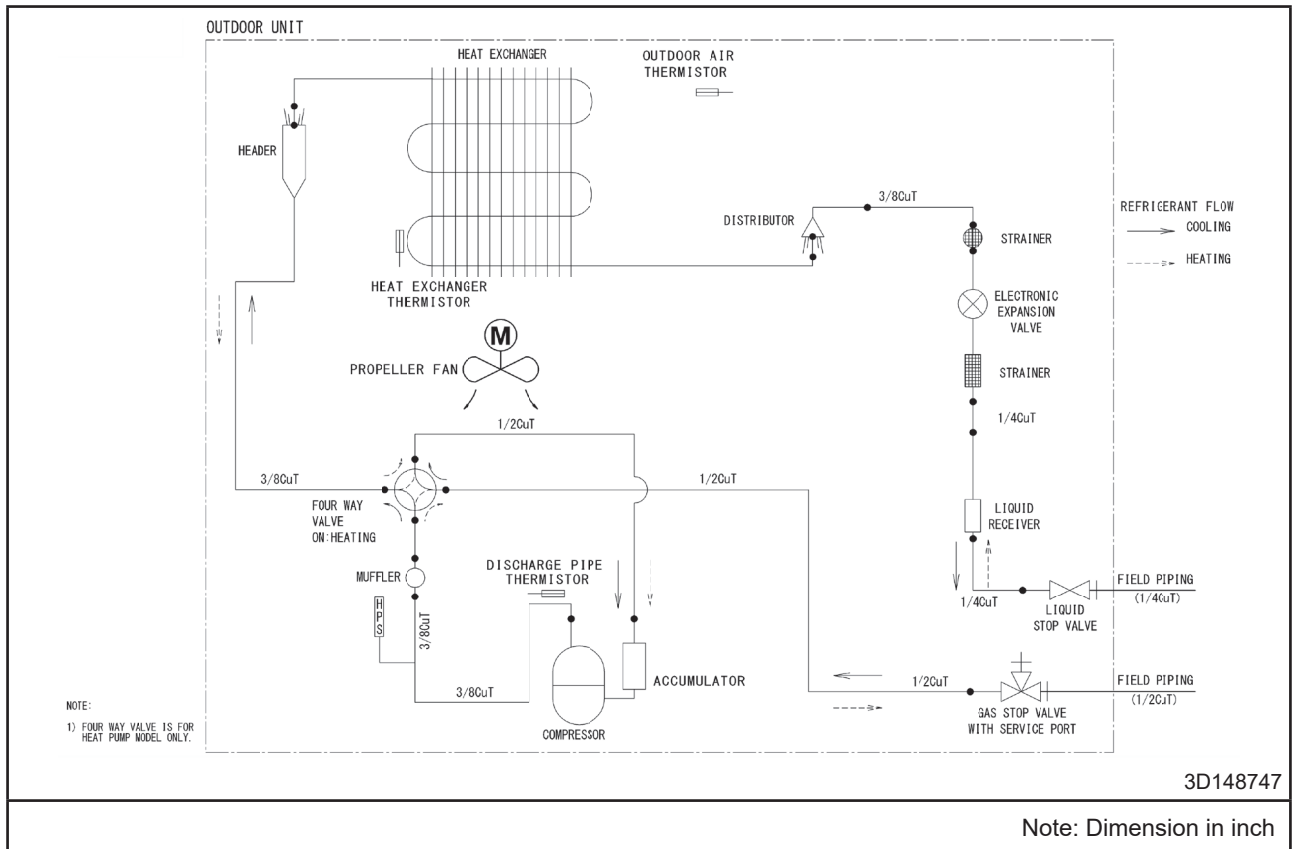

Model : RKF24A, RXF24A

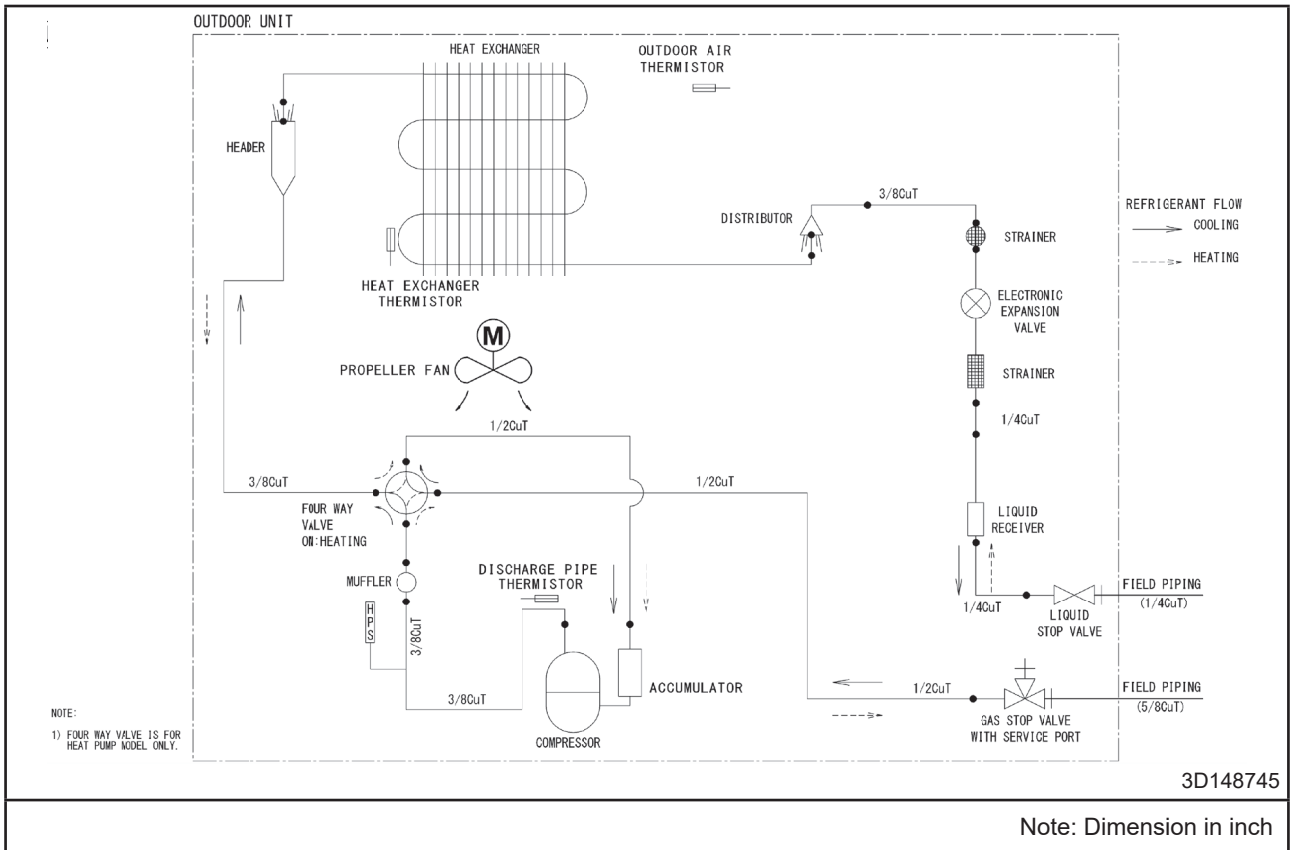

# Capacity Tables

## Cooling Only

Model : FTKF09A - RKF09A

AFR	12.20
BPF	0.23

Cooling: 208-230V 60Hz  
Temp.: Celsius/TC,SHC,PI: kW

Indoor Temperature °C	Outdoor temperature [°C DB]																											
	10			20			25			30			32			35			40			46			48			
	EWB	EDB	°C	TC	SHC	PI	TC	SHC	PI	TC	SHC	PI	TC	SHC	PI	TC	SHC	PI	TC	SHC	PI	TC	SHC	PI	TC	SHC	PI	
14	20	3.18	2.53	0.54	2.70	2.31	0.55	2.58	2.25	0.60	2.45	2.19	0.66	2.41	2.17	0.68	2.33	2.14	0.71	2.21	2.08	0.77	1.06	1.06	0.46	1.03	1.03	0.46
16	22	3.46	2.55	0.55	2.83	2.27	0.56	2.70	2.21	0.61	2.57	2.16	0.66	2.53	2.14	0.68	2.45	2.11	0.71	2.33	2.06	0.77	1.15	1.13	0.46	1.13	1.11	0.45
18	25	3.74	2.74	0.55	2.95	2.41	0.56	2.83	2.36	0.61	2.70	2.31	0.66	2.65	2.29	0.69	2.57	2.26	0.72	2.45	2.21	0.77	1.24	1.20	0.45	1.22	1.19	0.44
19	27	3.88	2.92	0.55	3.01	2.57	0.56	2.88	2.52	0.61	2.76	2.48	0.66	2.71	2.46	0.69	2.64	2.43	0.72	2.52	2.38	0.78	1.29	1.24	0.44	1.27	1.23	0.44
22	30	4.30	2.89	0.56	3.19	2.49	0.56	3.07	2.45	0.62	2.94	2.41	0.67	2.89	2.39	0.69	2.82	2.37	0.73	2.70	2.33	0.78	1.42	1.35	0.43	1.41	1.35	0.43
24	32	4.58	2.86	0.56	3.31	2.44	0.57	3.19	2.40	0.62	3.07	2.36	0.68	3.01	2.35	0.70	2.94	2.32	0.73	2.82	2.29	0.78	1.51	1.43	0.43	1.50	1.42	0.42

Cooling: 208-230V 60Hz  
Temp.: Fahrenheit/TC,SHC: kBTU/h / PI: kW

Indoor Temperature °F	Outdoor temperature [°F DB]																											
	50.0			68.0			77.0			86.0			89.6			95.0			104.0			114.8			118.4			
	EWB	EDB	°F	TC	SHC	PI	TC	SHC	PI	TC	SHC	PI	TC	SHC	PI	TC	SHC	PI	TC	SHC	PI	TC	SHC	PI	TC	SHC	PI	
57.2	68.0	10.83	8.64	0.54	9.22	7.87	0.55	8.80	7.67	0.60	8.38	7.48	0.66	8.21	7.40	0.68	7.96	7.29	0.71	7.53	7.09	0.77	3.63	3.63	0.46	3.52	3.52	0.46
60.8	71.6	11.79	8.69	0.55	9.64	7.73	0.56	9.22	7.55	0.61	8.78	7.36	0.66	8.63	7.30	0.68	8.38	7.19	0.71	7.96	7.01	0.77	3.94	3.85	0.46	3.84	3.78	0.45
64.4	77.0	12.75	9.34	0.56	10.06	8.22	0.56	9.64	8.06	0.61	9.22	7.88	0.66	9.05	7.82	0.69	8.78	7.71	0.72	8.37	7.55	0.77	4.24	4.10	0.45	4.16	4.05	0.44
66.2	80.6	13.22	9.96	0.55	10.25	8.77	0.56	9.84	8.61	0.61	9.41	8.45	0.66	9.25	8.38	0.69	9.00	8.29	0.72	8.59	8.13	0.78	4.40	4.23	0.44	4.32	4.18	0.44
71.6	86.0	14.66	9.86	0.56	10.88	8.51	0.56	10.47	8.36	0.62	10.04	8.22	0.67	9.87	8.16	0.69	9.62	8.08	0.73	9.22	7.94	0.78	4.86	4.61	0.43	4.81	4.59	0.43
75.2	89.6	15.61	9.75	0.56	11.29	8.32	0.57	10.88	8.19	0.62	10.47	8.06	0.68	10.29	8.01	0.70	10.04	7.93	0.73	9.62	7.80	0.78	5.16	4.87	0.43	5.13	4.86	0.42

Symbols

- AFR Air Flow rate (m3/min)
- BPF Bypass factor
- EWB Entering Wet Bulb (°C) / (°F)
- EDB Entering Dry Bulb (°C) / (°F)
- TC Total Capacity (kW) / (kBTU/h)
- SHC Sensible Heat Capacity (kW) / (kBTU/h)
- PI Power Input (kW)

NOTES:

- 1) Shows nominal(rated) capacities and power input
- 2) TC, SHC and PI must be calculated by interpolation using the figures in the above table
- 3) Capacities are based on the following condition  
Corresponding refrigerant piping length :25ft  
Level difference :0ft

Model : FTKF12A - RKF12A

AFR	12.35
BPF	0.22

Cooling: 208-230V 60Hz  
Temp.: Celsius/TC,SHC,PI: kW

Indoor Temperature		Outdoor temperature [°C DB]																										
		10			20			25			30			32			35			40			46			48		
EWB	EDB	TC	SHC	PI	TC	SHC	PI	TC	SHC	PI	TC	SHC	PI	TC	SHC	PI	TC	SHC	PI	TC	SHC	PI	TC	SHC	PI	TC	SHC	PI
14	20	4.23	3.08	0.72	3.60	2.76	0.73	3.44	2.68	0.81	3.27	2.60	0.88	3.21	2.56	0.90	3.11	2.52	0.95	2.94	2.44	1.02	1.42	1.42	1.38	1.38	1.38	0.61
16	22	4.61	3.11	0.73	3.77	2.71	0.74	3.60	2.63	0.81	3.43	2.55	0.88	3.37	2.53	0.91	3.27	2.48	0.95	3.11	2.41	1.03	1.54	1.51	1.51	1.51	1.48	0.60
18	25	4.98	3.32	0.73	3.93	2.84	0.74	3.77	2.77	0.82	3.60	2.70	0.89	3.54	2.67	0.91	3.43	2.63	0.96	3.27	2.56	1.03	1.66	1.60	1.60	1.63	1.58	0.59
19	27	5.17	3.50	0.74	4.01	3.00	0.74	3.85	2.93	0.82	3.68	2.86	0.89	3.61	2.84	0.91	3.52	2.80	0.96	3.36	2.73	1.04	1.72	1.65	1.65	1.69	1.64	0.58
22	30	5.73	3.47	0.74	4.25	2.89	0.75	4.09	2.83	0.82	3.92	2.77	0.89	3.86	2.75	0.92	3.76	2.72	0.97	3.60	2.66	1.04	1.90	1.80	1.88	1.79	1.79	0.57
24	32	6.10	3.43	0.75	4.41	2.82	0.76	4.25	2.77	0.83	4.09	2.71	0.90	4.02	2.69	0.93	3.92	2.66	0.97	3.76	2.61	1.04	2.02	1.90	2.00	1.90	1.90	0.56

Cooling: 208-230V 60Hz  
Temp.: Fahrenheit/TC,SHC: kBTU/h / PI: kW

Indoor Temperature		Outdoor temperature [°F DB]																										
		50.0			68.0			77.0			86.0			89.6			95.0			104.0			114.8			118.4		
EWB	EDB	TC	SHC	PI	TC	SHC	PI	TC	SHC	PI	TC	SHC	PI	TC	SHC	PI	TC	SHC	PI	TC	SHC	PI	TC	SHC	PI	TC	SHC	PI
57.2	68.0	14.45	10.52	0.72	12.30	9.41	0.73	11.73	9.13	0.81	11.17	8.86	0.88	10.95	8.75	0.90	10.62	8.59	0.95	10.05	8.32	1.02	4.84	4.84	4.69	4.69	4.69	0.61
60.8	71.6	15.72	10.62	0.73	12.86	9.24	0.74	12.29	8.98	0.81	11.71	8.71	0.88	11.51	8.62	0.91	11.17	8.47	0.95	10.62	8.22	1.03	5.25	5.14	5.12	5.04	5.04	0.60
64.4	77.0	16.99	11.32	0.73	13.41	9.69	0.74	12.86	9.46	0.82	12.29	9.21	0.89	12.07	9.12	0.91	11.71	8.97	0.96	11.16	8.74	1.03	5.66	5.47	5.40	5.55	5.40	0.59
66.2	80.6	17.63	11.96	0.74	13.67	10.23	0.74	13.12	10.00	0.82	12.55	9.76	0.89	12.33	9.67	0.91	12.00	9.54	0.96	11.45	9.32	1.04	5.86	5.64	5.59	5.77	5.58	0.58
71.6	86.0	19.54	11.85	0.74	14.51	9.88	0.75	13.95	9.67	0.82	13.38	9.47	0.89	13.16	9.39	0.92	12.82	9.27	0.97	12.29	9.08	1.04	6.48	6.14	6.12	6.41	6.12	0.57
75.2	89.6	20.82	11.71	0.75	15.06	9.63	0.76	14.51	9.44	0.83	13.95	9.26	0.90	13.72	9.18	0.93	13.38	9.07	0.97	12.82	8.89	1.04	6.88	6.49	6.57	6.84	6.48	0.56

- Symbols
- AFR Air Flow rate (m<sup>3</sup>/min)
  - BPF Bypass factor
  - EWB Entering Wet Bulb (°C) / (°F)
  - EDB Entering Dry Bulb (°C) / (°F)
  - TC Total Capacity (kW) / (kBTU/h)
  - SHC Sensible Heat Capacity (kW) / (kBTU/h)
  - PI Power Input (kW)
- NOTES:
- 1) [Shaded Box] Shows nominal (rated) capacities and power input
  - 2) TC, SHC and PI must be calculated by interpolation using the figures in the above table
  - 3) Capacities are based on the following condition  
Corresponding refrigerant piping length :.25ft  
Level difference :0ft

3D148831A

Model : FTKF18A - RKF18A

AFR	20.27
BPF	0.32

Cooling: 208-230V 60Hz  
Temp.: Celsius/TC,SHC,PI: kW

Indoor Temperature		Outdoor temperature [°C DB]																										
°C	EDB	10			20			25			30			32			35			40			46			50		
		TC	SHC	PI	TC	SHC	PI	TC	SHC	PI	TC	SHC	PI	TC	SHC	PI	TC	SHC	PI	TC	SHC	PI	TC	SHC	PI			
14	20	5.95	4.27	0.96	5.44	4.11	1.15	5.18	3.98	1.27	4.94	3.86	1.38	4.84	3.81	1.42	4.69	3.74	1.50	4.44	3.62	1.61	3.75	3.29	1.67	1.64	0.82	
16	22	6.20	4.38	0.96	5.68	4.03	1.17	5.43	3.91	1.27	5.18	3.79	1.39	5.09	3.75	1.44	4.94	3.69	1.50	4.69	3.57	1.61	4.01	3.28	1.66	1.90	0.81	
18	25	6.44	4.45	0.97	5.93	4.22	1.17	5.68	4.11	1.29	5.43	4.01	1.39	5.34	3.96	1.44	5.18	3.90	1.51	4.93	3.79	1.62	4.28	3.53	1.65	2.17	0.80	
19	27	6.56	4.67	0.97	6.04	4.45	1.17	5.80	4.34	1.29	5.55	4.24	1.39	5.45	4.20	1.44	5.30	4.14	1.51	5.06	4.04	1.63	4.41	3.78	1.65	2.30	0.80	
22	30	6.93	4.49	0.99	6.41	4.29	1.18	6.17	4.20	1.30	5.92	4.11	1.41	5.82	4.07	1.45	5.67	4.02	1.52	5.43	3.93	1.63	4.80	3.71	1.63	2.69	0.78	
24	32	7.17	4.36	0.99	6.66	4.18	1.19	6.41	4.10	1.30	6.17	4.02	1.42	6.06	3.98	1.46	5.92	3.93	1.53	5.67	3.85	1.64	5.07	3.66	1.62	2.96	0.77	

Cooling: 208-230V 60Hz  
Temp.: Fahrenheit/TC,SHC: kBtu/h /PI: kW

Indoor Temperature		Outdoor temperature [°F DB]																										
°F	EDB	50.0			68.0			77.0			86.0			89.6			95.0			104.0			114.8			122.0		
		TC	SHC	PI	TC	SHC	PI	TC	SHC	PI	TC	SHC	PI	TC	SHC	PI	TC	SHC	PI	TC	SHC	PI	TC	SHC	PI			
57.2	68.0	20.31	14.92	0.96	18.55	14.02	1.15	17.69	13.58	1.27	16.84	13.16	1.38	16.51	13.00	1.42	16.01	12.76	1.50	15.15	12.34	1.61	12.80	11.23	1.67	5.60	0.82	
60.8	71.6	21.14	14.60	0.96	19.39	13.76	1.17	18.53	13.35	1.27	17.66	12.95	1.39	17.36	12.81	1.44	16.84	12.57	1.50	16.01	12.20	1.61	13.70	11.18	1.66	6.50	0.81	
64.4	77.0	21.97	15.18	0.97	20.23	14.40	1.17	19.39	14.04	1.29	18.53	13.67	1.39	18.20	13.53	1.44	17.66	13.30	1.51	16.83	12.95	1.62	14.60	12.03	1.65	7.39	0.80	
66.2	80.6	22.39	15.93	0.97	20.62	15.17	1.17	19.79	14.82	1.29	18.93	14.46	1.39	18.60	14.33	1.44	18.10	14.12	1.51	17.27	13.78	1.63	15.04	12.91	1.65	7.84	0.80	
71.6	86.0	23.64	15.31	0.99	21.88	14.64	1.18	21.04	14.33	1.30	20.19	14.02	1.41	19.85	13.90	1.45	19.34	13.71	1.52	18.53	13.42	1.63	16.39	12.67	1.63	9.19	0.78	
75.2	89.6	24.47	14.89	0.99	22.71	14.27	1.19	21.88	13.99	1.30	21.04	13.71	1.42	20.69	13.59	1.46	20.19	13.42	1.53	19.34	13.14	1.64	17.29	12.48	1.62	10.09	0.77	

Symbols

- AFR Air Flow rate (m<sup>3</sup>/min)
- BPF Bypass factor
- EWB Entering Wet Bulb (°C) / (°F)
- EDB Entering Dry Bulb (°C) / (°F)
- TC Total Capacity (kW) / (kBtu/h)
- SHC Sensible Heat Capacity (kW) / (kBtu/h)
- PI Power Input (kW)

NOTES:

- 1)   Shows nominal (rated) capacities and power input
- 2) TC, SHC and PI must be calculated by interpolation using the figures in the above table
- 3) Capacities are based on the following condition  
Corresponding refrigerant piping length: 25ft  
Level difference .0ft



Model : FTKF24A- RKF24A

AFR	20.27
BPF	0.27

Cooling: 208-230V 60Hz  
Temp.: Celsius/TC,SHC,PI: kW

Indoor Temperature		Outdoor temperature [°C DB]																										
		10			20			25			30			32			35			40			46			50		
EWB	EDB	°C	TC	SHC	PI	TC	SHC	PI	TC	SHC	PI	TC	SHC	PI	TC	SHC	PI	TC	SHC	PI	TC	SHC	PI	TC	SHC	PI		
14	20	7.37	5.21	1.18	1.43	6.42	4.70	1.57	6.11	4.54	1.71	5.99	4.48	1.85	5.50	4.23	1.99	4.64	3.81	2.07	2.03	2.03	2.07	2.03	2.03	2.03	1.02	
16	22	7.67	5.09	1.19	1.44	6.72	4.62	1.58	6.41	4.47	1.72	6.30	4.41	1.78	6.11	4.32	1.85	5.81	4.18	2.00	4.97	3.80	2.06	2.06	2.36	2.36	1.00	
18	25	7.97	5.26	1.20	1.45	7.03	4.82	1.59	6.72	4.68	1.73	6.60	4.63	1.78	6.41	4.54	1.87	6.11	4.41	2.00	5.29	4.06	2.04	2.04	2.68	2.68	0.99	
19	27	8.12	5.48	1.21	1.45	7.18	5.06	1.59	6.87	4.92	1.73	6.75	4.87	1.78	6.57	4.79	1.87	6.26	4.67	2.02	5.46	4.34	2.04	2.04	2.85	2.85	0.98	
22	30	8.57	5.26	1.22	1.47	7.63	4.88	1.61	7.32	4.76	1.74	7.20	4.72	1.80	7.02	4.65	1.89	6.72	4.54	2.02	5.95	4.25	2.02	2.02	3.33	3.33	0.97	
24	32	8.88	5.10	1.23	1.48	7.94	4.76	1.61	7.63	4.65	1.76	7.50	4.60	1.81	7.32	4.54	1.89	7.02	4.43	2.03	6.27	4.18	2.01	2.01	3.66	3.66	0.95	

Cooling: 208-230V 60Hz  
Temp.: Fahrenheit/TC,SHC: kBtu/h /PI: kW

Indoor Temperature		Outdoor temperature [°F DB]																										
		50.0			68.0			77.0			86.0			89.6			95.0			104.0			114.8			122.0		
EWB	EDB	°F	TC	SHC	PI	TC	SHC	PI	TC	SHC	PI	TC	SHC	PI	TC	SHC	PI	TC	SHC	PI	TC	SHC	PI	TC	SHC	PI		
57.2	68.0	25.13	17.79	1.18	1.43	21.89	16.04	1.57	20.85	15.50	1.71	20.44	15.29	1.76	19.82	14.97	1.85	18.75	14.44	1.99	15.84	13.02	2.07	6.93	6.93	1.02		
60.8	71.6	26.16	17.38	1.19	1.44	22.94	15.76	1.58	21.86	15.24	1.72	21.49	15.06	1.78	20.85	14.75	1.85	19.82	14.27	2.00	16.95	12.96	2.06	8.04	8.04	1.00		
64.4	77.0	27.19	17.95	1.20	1.45	24.00	16.46	1.59	22.94	15.98	1.73	22.53	15.79	1.78	21.86	15.50	1.87	20.83	15.04	2.00	18.07	13.87	2.04	9.15	9.15	0.99		
66.2	80.6	27.71	18.71	1.21	1.45	24.49	17.26	1.59	23.43	16.80	1.73	23.02	16.62	1.78	22.40	16.36	1.87	21.37	15.92	2.02	18.62	14.79	2.04	9.71	9.71	0.98		
71.6	86.0	29.26	17.94	1.22	1.47	26.05	16.66	1.61	24.98	16.25	1.74	24.58	16.09	1.80	23.94	15.85	1.89	22.94	15.48	2.02	20.29	14.51	2.02	11.37	11.37	0.97		
75.2	89.6	30.29	17.40	1.23	1.48	27.08	16.23	1.61	26.05	15.86	1.76	25.60	15.71	1.81	24.98	15.49	1.89	23.94	15.13	2.03	21.40	14.28	2.01	12.49	12.49	0.95		

Symbols

- AFR Air Flow rate (m<sup>3</sup>/min)
- BPF Bypass factor
- EWB Entering Wet Bulb (°C) / (°F)
- EDB Entering Dry Bulb (°C) / (°F)
- TC Total Capacity (kW) / (kBtu/h)
- SHC Sensible Heat Capacity (kW) / (kBtu/h)
- PI Power Input (kW)

NOTES:

- 1)      Shows nominal (rated) capacities and power input
- 2) TC, SHC and PI must be calculated by interpolation using the figures in the above table
- 3) Capacities are based on the following condition  
Corresponding refrigerant piping length: 25ft  
Level difference 0ft

# Heatpump

Model : FTXF09A - RXF09A

AFR	12.20
BPF	0.23

Cooling: 208-230V 60Hz  
Temp : Celsius/TC,SHC,PI: kW

Indoor Temperature		Outdoor temperature [°C DB]																															
		20.0				25.0				30.0				32.0				35.0				40.0				46.0				48.0			
EWB	EDB	TC	SHC	PI	TC	SHC	PI	TC	SHC	PI	TC	SHC	PI	TC	SHC	PI	TC	SHC	PI	TC	SHC	PI	TC	SHC	PI	TC	SHC	PI	TC	SHC	PI		
14.0	20.0	3.18	2.53	0.54	2.70	2.31	0.55	2.58	2.25	0.60	2.45	2.19	0.66	2.41	2.17	0.66	2.33	2.14	0.71	2.21	2.08	0.77	2.06	1.93	1.13	1.11	0.45						
16.0	22.0	3.46	2.55	0.55	2.83	2.27	0.56	2.70	2.21	0.61	2.57	2.14	0.68	2.45	2.11	0.71	2.33	2.06	0.77	2.15	2.03	0.86	1.93	1.13	1.11	0.45							
18.0	25.0	3.74	2.74	0.55	2.95	2.41	0.56	2.83	2.36	0.61	2.70	2.31	0.66	2.65	2.29	0.69	2.57	2.26	0.72	2.45	2.21	0.77	2.24	2.06	1.19	1.19	0.44						
19.4	26.7	3.88	2.92	0.55	3.01	2.57	0.56	2.88	2.52	0.61	2.76	2.48	0.66	2.71	2.46	0.69	2.64	2.43	0.72	2.52	2.38	0.78	2.29	2.12	1.29	1.24	0.44						
22.0	30.0	4.30	2.89	0.56	3.19	2.49	0.56	3.19	2.49	0.62	2.94	2.41	0.67	2.89	2.39	0.69	2.82	2.37	0.73	2.70	2.33	0.78	2.42	2.14	1.41	1.35	0.43						
24.0	32.0	4.58	2.86	0.56	3.31	2.44	0.57	3.19	2.40	0.62	3.07	2.36	0.68	3.01	2.35	0.70	2.94	2.32	0.73	2.82	2.29	0.78	2.51	1.43	1.50	1.42	0.42						

Cooling: 208-230V 60Hz  
Temp : Fahrenheit/TC,SHC: kBTU/h / PI: kW

Indoor Temperature		Outdoor temperature [°F DB]																															
		68.0				77.0				86.0				89.6				95.0				104.0				114.8				118.4			
EWB	EDB	TC	SHC	PI	TC	SHC	PI	TC	SHC	PI	TC	SHC	PI	TC	SHC	PI	TC	SHC	PI	TC	SHC	PI	TC	SHC	PI	TC	SHC	PI	TC	SHC	PI		
57.2	68.0	10.83	8.64	0.54	9.22	7.87	0.55	8.80	7.67	0.60	8.38	7.48	0.66	8.21	7.40	0.68	7.96	7.29	0.71	7.53	7.09	0.77	6.63	3.63	3.63	0.46	3.52	3.52	0.46				
60.8	71.6	11.79	8.69	0.55	9.64	7.73	0.56	9.22	7.55	0.61	8.78	7.36	0.66	8.63	7.30	0.68	8.38	7.19	0.71	7.96	7.01	0.77	3.94	3.85	3.85	0.46	3.84	3.78	0.45				
64.4	77.0	12.75	9.34	0.55	10.06	8.22	0.56	9.64	8.06	0.61	9.22	7.88	0.66	9.05	7.82	0.69	8.78	7.71	0.72	8.37	7.55	0.77	4.24	4.10	4.10	0.45	4.16	4.05	0.44				
66.9	80.1	13.22	9.96	0.55	10.25	8.77	0.56	9.84	8.61	0.61	9.41	8.45	0.66	9.25	8.38	0.69	9.00	8.29	0.72	8.59	8.13	0.78	4.40	4.23	4.23	0.44	4.32	4.18	0.44				
71.6	86.0	14.66	9.86	0.56	10.88	8.51	0.56	10.47	8.36	0.62	10.04	8.22	0.67	9.87	8.16	0.69	9.62	8.08	0.73	9.22	7.94	0.78	4.86	4.61	4.61	0.43	4.81	4.59	0.43				
75.2	89.6	15.61	9.75	0.56	11.29	8.32	0.57	10.88	8.19	0.62	10.47	8.06	0.68	10.29	8.01	0.70	10.04	7.93	0.73	9.62	7.80	0.78	5.16	4.87	4.87	0.43	5.13	4.86	0.42				

Heating: 208-230V 60Hz  
Temp : Celsius/TC,PI: kW

Indoor Temperature		Outdoor temperature [°C WB]																										
		-15.0				-10.0				-5.0				0.0				6.1				18.0						
EWB	EDB	TC	SHC	PI	TC	SHC	PI	TC	SHC	PI	TC	SHC	PI	TC	SHC	PI	TC	SHC	PI	TC	SHC	PI	TC	SHC	PI	TC	SHC	PI
15.0	15.0	1.28	0.43	1.55	0.47	1.91	0.46	2.19	0.62	3.03	0.70	3.30	0.73	3.77	0.78													
21.1	21.1	1.21	0.45	1.47	0.47	1.83	0.48	2.11	0.64	2.93	0.72	3.20	0.74	3.67	0.80													
22.0	22.0	1.18	0.45	1.44	0.47	1.80	0.49	2.07	0.64	2.89	0.72	3.16	0.75	3.63	0.80													
24.0	24.0	1.14	0.45	1.40	0.48	1.76	0.49	2.04	0.65	2.85	0.73	3.12	0.76	3.59	0.81													
25.0	25.0	1.13	0.46	1.39	0.48	1.75	0.50	2.02	0.65	2.83	0.73	3.09	0.76	3.57	0.81													
27.0	27.0	1.10	0.46	1.36	0.49	1.71	0.50	1.99	0.65	2.79	0.74	3.05	0.76	3.53	0.82													

Heating: 208-230V 60Hz  
Temp : Fahrenheit/TC: kBTU/h / PI: kW

Indoor Temperature		Outdoor temperature [°F WB]																											
		5.0				14.0				23.0				32.0				43.0				50.0				64.4			
EWB	EDB	TC	SHC	PI	TC	SHC	PI	TC	SHC	PI	TC	SHC	PI	TC	SHC	PI	TC	SHC	PI	TC	SHC	PI	TC	SHC	PI	TC	SHC	PI	
59.0	59.0	4.38	0.43	5.28	0.46	6.53	0.47	7.48	0.62	10.34	0.70	11.25	0.73	12.86	0.78														
70.0	70.0	4.13	0.45	5.01	0.47	6.25	0.48	7.19	0.64	10.00	0.72	10.91	0.74	12.52	0.80														
71.6	71.6	4.01	0.45	4.90	0.47	6.13	0.49	7.07	0.64	9.86	0.72	10.77	0.75	12.38	0.80														
75.2	75.2	3.90	0.45	4.79	0.48	6.01	0.49	6.95	0.65	9.72	0.73	10.63	0.76	12.24	0.81														
77.0	77.0	3.85	0.46	4.73	0.48	5.96	0.50	6.91	0.65	9.66	0.73	10.55	0.76	12.17	0.81														
80.6	80.6	3.74	0.46	4.63	0.49	5.83	0.50	6.78	0.65	9.51	0.74	10.42	0.76	12.04	0.82														

Symbols

- AFR Air Flow rate (m<sup>3</sup>/min)
- BPF Bypass factor (°C) / (°F)
- EWB Entering Wet Bulb (°C) / (°F)
- EDB Entering Dry Bulb (°C) / (°F)
- TC Total Capacity (kW) / (kBTU/h)
- SHC Sensible Heat Capacity (kW) / (kBTU/h)
- PI Power Input (kW)

NOTES:

- 1) Shows nominal(rated) capacities and power input
- 2) TC, SHC and PI must be calculated by interpolation using the figures in the above table
- 3) Capacities are based on the following condition  
Corresponding refrigerant piping length :25ft  
Level difference :0ft

Model : FTXF12A - RXF12A

AFR	12.35
BPF	0.22

Cooling: 208-230V 60Hz  
Temp.: Celsius/TC,SHC,PI:KW

Indoor Temperature	Outdoor temperature [°C DB]																									
	10.0			20.0			25.0			30.0			32.0			35.0			40.0			46.0			48.0	
EWB	EDB	TC	SHC	PI	TC	SHC	PI	TC	SHC	PI	TC	SHC	PI	TC	SHC	PI	TC	SHC	PI	TC	SHC	PI	TC	SHC	PI	
14.0	20.0	4.23	3.08	0.72	3.60	0.73	3.44	2.68	0.81	3.27	2.60	0.88	3.21	2.56	0.90	3.11	2.52	0.95	2.94	2.44	1.02	1.42	1.42	1.38	1.38	0.61
16.0	22.0	4.61	3.11	0.73	3.77	0.74	3.60	2.63	0.81	3.43	2.55	0.88	3.37	2.53	0.91	3.27	2.48	0.95	3.11	2.41	1.03	1.54	1.51	1.50	1.48	0.60
18.0	25.0	4.98	3.32	0.73	3.93	0.74	3.77	2.77	0.82	3.60	2.70	0.89	3.54	2.67	0.91	3.43	2.63	0.96	3.27	2.56	1.03	1.66	1.60	1.63	1.58	0.59
19.4	26.7	5.17	3.50	0.74	4.01	0.75	3.85	2.93	0.82	3.68	2.86	0.89	3.61	2.84	0.91	3.52	2.80	0.96	3.36	2.73	1.04	1.72	1.65	1.69	1.64	0.58
22.0	30.0	5.73	3.47	0.74	4.25	0.75	4.09	2.83	0.82	3.92	2.77	0.89	3.86	2.75	0.92	3.76	2.72	0.97	3.60	2.66	1.04	1.90	1.80	1.88	1.79	0.57
24.0	32.0	6.10	3.43	0.75	4.41	0.76	4.25	2.77	0.83	4.09	2.71	0.90	4.02	2.69	0.93	3.92	2.66	0.97	3.76	2.61	1.04	2.02	1.90	2.00	1.90	0.56

Cooling: 208-230V 60Hz  
Temp.: Fahrenheit/TC,SHC: kBTU/h / PI: kW

Indoor Temperature	Outdoor temperature [°F DB]																									
	50.0			68.0			77.0			86.0			89.6			95.0			104.0			114.8			118.4	
EWB	EDB	°F	TC	SHC	PI	TC	SHC	PI	TC	SHC	PI	TC	SHC	PI	TC	SHC	PI	TC	SHC	PI	TC	SHC	PI	TC	SHC	PI
57.2	68.0	14.45	10.52	0.72	12.30	0.73	11.73	9.13	0.81	11.17	8.86	0.88	10.95	8.75	0.90	10.62	8.59	0.95	10.05	8.32	1.02	4.84	4.84	4.69	4.69	0.61
60.8	71.6	15.72	10.62	0.73	12.86	0.74	12.29	8.98	0.81	11.71	8.71	0.88	11.51	8.62	0.91	11.17	8.47	0.95	10.62	8.22	1.03	5.14	5.14	5.04	5.04	0.60
64.4	77.0	16.99	11.32	0.73	13.41	0.74	12.86	9.46	0.82	12.29	9.21	0.89	12.07	9.12	0.91	11.71	8.97	0.96	11.16	8.74	1.03	5.66	5.47	5.55	5.40	0.59
66.9	80.1	17.63	11.96	0.74	13.67	0.74	13.12	10.00	0.82	12.55	9.76	0.89	12.33	9.67	0.91	12.00	9.54	0.96	11.45	9.32	1.04	5.86	5.64	5.69	5.58	0.58
71.6	86.0	19.54	11.85	0.74	14.51	0.75	13.95	9.67	0.82	13.38	9.47	0.89	13.16	9.39	0.92	12.82	9.27	0.97	12.29	9.08	1.04	6.48	6.14	6.12	6.12	0.57
75.2	89.6	20.82	11.71	0.75	15.06	0.76	14.51	9.44	0.83	13.95	9.26	0.90	13.72	9.18	0.93	13.38	9.07	0.97	12.82	8.89	1.04	6.88	6.49	6.57	6.48	0.56

Heating: 208-230V 60Hz  
Temp.: Celsius/TC,PI: kW

Indoor Temperature	Outdoor temperature [°C WB]																
	-15.0			-10.0			0.0			6.1			10.0			18.0	
EDB	°C	TC	PI	TC	PI	TC	PI	TC	PI	TC	PI	TC	PI	TC	PI	TC	PI
15.0	15.0	1.73	0.63	2.09	0.66	2.58	0.68	2.96	0.89	4.09	1.02	4.45	1.05	5.09	1.13	5.09	1.13
21.1	16.3	0.65	1.98	0.68	2.47	0.70	2.85	0.92	3.96	1.04	4.32	1.07	4.95	1.15	4.95	1.15	4.95
22.0	15.9	0.65	1.94	0.69	2.43	0.71	2.80	0.92	3.90	1.04	4.26	1.08	4.90	1.16	4.90	1.16	4.90
24.0	15.4	0.66	1.90	0.69	2.38	0.71	2.75	0.93	3.85	1.05	4.21	1.09	4.84	1.17	4.84	1.17	4.84
25.0	15.2	0.66	1.87	0.69	2.36	0.72	2.73	0.94	3.82	1.06	4.17	1.10	4.82	1.17	4.82	1.17	4.82
27.0	14.8	0.67	1.83	0.71	2.31	0.73	2.68	0.94	3.76	1.07	4.12	1.10	4.76	1.18	4.76	1.18	4.76

Heating: 208-230V 60Hz  
Temp.: Fahrenheit/TC: kBTU/h / PI: kW

Indoor Temperature	Outdoor temperature [°F WB]																			
	5.0			14.0			23.0			32.0			43.0			50.0			64.4	
EDB	°F	TC	PI	TC	PI	TC	PI	TC	PI	TC	PI	TC	PI	TC	PI	TC	PI	TC	PI	
59.0	59.0	5.91	0.63	7.13	0.66	8.81	0.68	10.10	0.89	13.96	1.02	15.19	1.05	17.37	1.13	17.37	1.13	17.37	1.13	
70.0	55.8	0.65	6.76	0.68	8.43	0.70	9.71	0.92	13.50	1.04	14.73	1.07	16.90	1.15	16.90	1.15	16.90	1.15	16.90	
71.6	54.1	0.65	6.62	0.69	8.28	0.71	9.54	0.92	13.30	1.04	14.54	1.08	16.72	1.16	16.72	1.16	16.72	1.16	16.72	
75.2	52.7	0.66	6.47	0.69	8.11	0.71	9.38	0.93	13.13	1.05	14.35	1.09	16.53	1.17	16.53	1.17	16.53	1.17	16.53	
77.0	51.9	0.66	6.38	0.69	8.05	0.72	9.33	0.94	13.04	1.06	14.24	1.10	16.44	1.17	16.44	1.17	16.44	1.17	16.44	
80.6	50.5	0.67	6.25	0.71	7.88	0.73	9.15	0.94	12.84	1.07	14.07	1.10	16.25	1.18	16.25	1.18	16.25	1.18	16.25	

Symbols

- AFR Air Flow rate (m<sup>3</sup>/min)
- BPF Bypass factor
- EWB Entering Wet Bulb (°C) / (°F)
- EDB Entering Dry Bulb (°C) / (°F)
- TC Total Capacity (kW) / (kBTU/h)
- SHC Sensible Heat Capacity (kW) / (kBTU/h)
- PI Power Input (kW)

NOTES:

- 1) [ ] Shows nominal (rated) capacities and power input
- 2) TC, SHC and PI must be calculated by interpolation using the figures in the above table
- 3) Capacities are based on the following condition  
Corresponding refrigerant piping length :25ft  
Level difference :0ft

Model : FTXF18A - RXF18A

AFR	20.27
BPF	0.32

Cooling: 208-230V 60Hz  
Temp.: Celsius/TC,SHC,PI: kW

Indoor Temperature		Outdoor temperature [°C DB]																										
		10.0		20.0		25.0		30.0		32.0		35.0		40.0		46.0		50.0										
°F	°C	TC	SHC	PI	TC	SHC	PI	TC	SHC	PI	TC	SHC	PI	TC	SHC	PI	TC	SHC	PI									
14.0	20.0	5.95	4.37	0.96	5.44	4.11	1.15	5.18	3.98	1.27	4.94	3.86	1.38	4.84	3.81	1.42	4.69	3.74	1.50	4.44	3.62	1.61	3.75	3.29	1.67	1.64	1.64	0.82
16.0	22.0	6.20	4.28	0.96	5.68	4.03	1.17	5.43	3.91	1.27	5.18	3.79	1.39	5.09	3.75	1.44	4.94	3.69	1.50	4.69	3.57	1.61	3.28	1.66	1.90	1.90	0.81	
18.0	25.0	6.44	4.45	0.97	5.93	4.22	1.17	5.68	4.11	1.29	5.43	4.01	1.39	5.34	3.96	1.44	5.18	3.90	1.51	4.93	3.79	1.62	4.28	3.53	1.65	2.17	2.17	0.80
19.4	26.7	6.56	4.67	0.97	6.04	4.45	1.17	5.80	4.34	1.29	5.55	4.24	1.39	5.45	4.20	1.44	5.30	4.14	1.51	5.06	4.04	1.63	4.41	3.78	1.65	2.30	2.30	0.80
22.0	30.0	6.93	4.49	0.99	6.41	4.29	1.18	6.17	4.10	1.30	5.92	4.11	1.41	5.82	4.07	1.45	5.67	4.02	1.52	5.43	3.85	1.63	4.80	3.71	1.63	2.69	2.69	0.78
24.0	32.0	7.17	4.36	0.99	6.66	4.18	1.19	6.41	4.10	1.30	6.17	4.02	1.42	6.06	3.98	1.46	5.92	3.93	1.53	5.67	3.85	1.64	5.07	3.66	1.62	2.96	2.96	0.77

Cooling: 208-230V 60Hz  
Temp.: Fahrenheit/TC,SHC: kBTU/h / PI: kW

Indoor Temperature		Outdoor temperature [°F DB]																										
		50.0		68.0		77.0		86.0		89.6		95.0		104.0		114.8		122.0										
°F	°C	TC	SHC	PI	TC	SHC	PI	TC	SHC	PI	TC	SHC	PI	TC	SHC	PI	TC	SHC	PI									
57.2	68.0	20.31	14.92	0.96	18.55	14.02	1.15	17.69	13.58	1.27	16.84	13.16	1.38	16.51	13.00	1.42	16.01	12.76	1.50	15.15	12.34	1.61	12.80	11.23	1.67	5.60	5.60	0.82
60.8	71.6	21.14	14.60	0.96	19.39	13.76	1.17	18.53	13.35	1.27	17.66	12.95	1.39	17.36	12.81	1.44	16.84	12.57	1.50	16.01	12.20	1.61	13.70	11.18	1.66	6.50	6.50	0.81
64.4	77.0	21.97	15.18	0.97	20.23	14.40	1.17	19.39	14.04	1.29	18.53	13.67	1.39	18.20	13.53	1.44	17.66	13.30	1.51	16.83	12.95	1.62	14.60	12.03	1.65	7.39	7.39	0.80
66.9	80.1	22.39	15.93	0.97	20.62	15.17	1.17	19.79	14.82	1.29	18.93	14.46	1.39	18.60	14.33	1.44	18.10	14.12	1.51	17.27	13.78	1.63	15.04	12.91	1.65	7.84	7.84	0.80
71.6	86.0	23.64	15.31	0.99	21.88	14.64	1.18	21.04	14.33	1.30	20.19	14.02	1.41	19.85	13.90	1.45	19.34	13.71	1.52	18.53	13.42	1.63	16.39	12.67	1.63	9.19	9.19	0.78
75.2	89.6	24.47	14.89	0.99	22.71	14.27	1.19	21.88	13.99	1.30	21.04	13.71	1.42	20.69	13.59	1.46	20.19	13.42	1.53	19.34	13.14	1.64	17.29	12.48	1.62	10.09	10.09	0.77

Heating: 208-230V 60Hz  
Temp.: Celsius/TC,PI: kW

Indoor Temperature		Outdoor temperature [°C WB]													
		-15.0		-10.0		0.0		6.1		10.0		18.0			
°C	°F	TC	PI	TC	PI	TC	PI	TC	PI	TC	PI	TC	PI		
15.0	27.0	2.77	1.06	3.34	1.12	4.13	1.16	4.74	1.51	6.55	1.72	7.12	1.78	8.91	2.21
21.1	26.2	1.10	3.17	1.15	3.96	1.18	4.55	1.56	6.33	1.76	6.90	1.82	8.14	2.15	
22.0	2.54	1.11	3.10	1.16	3.88	1.20	4.48	1.77	6.82	1.84	7.83	2.12			
24.0	2.47	1.11	3.04	1.18	3.80	1.21	4.40	1.58	6.15	1.78	6.73	1.85	7.52	2.10	
25.0	2.44	1.13	2.99	1.18	3.78	1.22	4.38	1.59	6.11	1.80	6.68	1.86	7.36	2.09	
27.0	2.37	1.13	2.93	1.20	3.69	1.23	4.29	1.60	6.02	1.82	6.60	1.87	7.06	2.07	

Heating: 208-230V 60Hz  
Temp.: Fahrenheit/TC,SHC: kBTU/h / PI: kW

Indoor Temperature		Outdoor temperature [°F WB]														
		5.0		14.0		23.0		32.0		43.0		50.0		64.4		
°F	°C	TC	SHC	PI	TC	SHC	PI	TC	SHC	PI	TC	SHC	PI	TC	SHC	PI
59.0	9.47	1.06	11.41	1.12	14.11	1.16	16.17	1.51	22.34	1.72	24.30	1.78	30.39	2.21		
70.0	8.93	1.10	10.82	1.15	13.50	1.18	15.54	1.56	21.60	1.76	23.56	1.82	27.76	2.15		
71.6	8.67	1.11	10.59	1.16	13.25	1.20	15.28	1.58	21.29	1.77	23.26	1.84	26.71	2.12		
75.2	8.43	1.11	10.36	1.18	12.98	1.21	15.01	1.58	21.00	1.78	22.96	1.85	25.65	2.10		
77.0	8.31	1.13	10.21	1.18	12.89	1.22	14.93	1.59	20.86	1.80	22.79	1.86	25.13	2.09		
80.6	8.09	1.13	10.00	1.20	12.61	1.23	14.65	1.60	20.55	1.82	22.51	1.87	24.08	2.07		

Symbols  
AFR Air Flow rate (m3/min)  
BPF Bypass factor  
EWB Entering Wet Bulb (°C) / (°F)  
EDB Entering Dry Bulb (°C) / (°F)  
TC Total Capacity (kW) / (kBTU/h)  
SHC Sensible Heat Capacity (kW) / (kBTU/h)  
PI Power Input (kW)

NOTES:

- 1) Shows nominal (rated) capacities and power input
- 2) TC, SHC and PI must be calculated by interpolation using the figures in the above table
- 3) Capacities are based on the following condition  
Corresponding refrigerant piping length :25ft  
Level difference :0ft

Model : FTXF24A - RXF24A

AFR	20.27
BPF	0.27

Cooling: 208-230V 60Hz  
Temp.: Celsius/TC,SHC,PI: kW

Indoor Temperature	Outdoor temperature [°C DB]																											
	10.0		20.0		25.0		30.0		32.0		40.0		46.0		50.0													
EWB	TC	SHC	PI	TC	SHC	PI	TC	SHC	PI	TC	SHC	PI	TC	SHC	PI	TC	SHC	PI										
14.0	20.0	7.37	5.21	1.18	1.43	4.87	1.43	6.42	4.70	1.57	6.11	4.54	1.71	5.99	4.48	1.76	5.81	4.39	1.85	5.50	4.23	1.99	4.64	3.81	2.07	2.03	2.03	1.02
16.0	22.0	7.67	5.09	1.19	1.44	4.77	1.44	6.72	4.62	1.58	6.41	4.47	1.72	6.30	4.41	1.78	6.11	4.32	1.85	5.81	4.18	2.00	4.97	3.80	2.06	2.36	2.36	1.00
18.0	25.0	7.97	5.26	1.20	1.45	4.96	1.45	7.03	4.82	1.59	6.72	4.68	1.73	6.60	4.63	1.78	6.41	4.54	1.87	6.11	4.41	2.00	5.29	4.06	2.04	2.88	2.68	0.99
19.4	26.7	8.12	5.48	1.21	1.45	5.19	1.45	7.18	5.06	1.59	6.87	4.92	1.73	6.75	4.87	1.78	6.57	4.79	1.87	6.26	4.67	2.02	5.46	4.34	2.04	2.85	2.85	0.98
22.0	30.0	8.57	5.26	1.22	1.48	5.00	1.47	7.63	4.88	1.61	7.32	4.76	1.74	7.20	4.72	1.80	7.02	4.65	1.89	6.72	4.54	2.02	5.95	4.25	2.02	3.33	3.33	0.97
24.0	32.0	8.88	5.10	1.23	1.48	4.86	1.48	7.94	4.76	1.61	7.63	4.65	1.76	7.50	4.60	1.81	7.32	4.54	1.89	7.02	4.43	2.03	6.27	4.18	2.01	3.66	3.37	0.95

Cooling: 208-230V 60Hz  
Temp.: Fahrenheit/TC,SHC,kBtu/h / PI: kW

Indoor Temperature	Outdoor temperature [°F DB]																											
	50.0		68.0		77.0		86.0		89.6		104.0		114.8		122.0													
EWB	TC	SHC	PI	TC	SHC	PI	TC	SHC	PI	TC	SHC	PI	TC	SHC	PI	TC	SHC	PI										
57.2	68.0	25.13	17.79	1.18	22.96	16.61	1.43	21.89	16.04	1.57	20.85	15.50	1.71	20.44	15.29	1.76	19.82	14.97	1.85	18.75	14.44	1.99	15.84	13.02	2.07	6.93	6.93	1.02
60.8	71.6	26.16	17.38	1.19	24.00	16.29	1.44	22.94	15.76	1.58	21.86	15.24	1.72	21.49	15.06	1.78	20.85	14.75	1.85	19.82	14.27	2.00	16.95	12.96	2.06	8.04	8.04	1.00
64.4	77.0	27.19	17.95	1.20	25.03	16.93	1.45	24.00	16.46	1.59	22.94	15.98	1.73	22.53	15.79	1.78	21.86	15.50	1.87	20.83	15.04	2.00	18.07	13.87	2.04	9.15	9.15	0.99
66.9	80.1	27.71	18.71	1.21	25.52	17.72	1.45	24.49	17.26	1.59	23.43	16.80	1.73	23.02	16.62	1.78	22.40	16.36	1.87	21.37	15.92	2.02	18.62	14.79	2.04	9.71	9.71	0.98
71.6	86.0	29.26	17.94	1.22	27.08	17.06	1.47	26.05	16.66	1.61	24.98	16.25	1.74	24.58	16.09	1.80	23.94	15.85	1.89	22.94	15.48	2.02	20.29	14.51	2.02	11.37	11.37	0.97
75.2	89.6	30.29	17.40	1.23	28.11	16.60	1.48	27.08	16.23	1.61	26.05	15.86	1.76	25.60	15.71	1.81	24.98	15.49	1.89	23.94	15.13	2.03	21.40	14.28	2.01	12.49	11.49	0.95

Heating: 208-230V 60Hz  
Temp.: Celsius/TC,PI: kW

Indoor Temperature	Outdoor temperature [°C WB]													
	-15.0		-10.0		-5.0		0.0		6.1		10.0		18.0	
EWB	TC	PI	TC	PI	TC	PI	TC	PI	TC	PI	TC	PI	TC	PI
15.0	3.03	1.25	3.65	1.31	4.52	1.36	5.18	1.78	7.15	2.03	7.78	2.09	9.73	2.59
21.1	2.86	1.29	3.46	1.35	4.32	1.39	4.98	1.83	6.92	2.07	7.55	2.14	8.89	2.53
22.0	2.78	1.31	3.39	1.37	4.24	1.41	4.89	1.84	6.82	2.08	7.45	2.16	8.55	2.50
24.0	2.70	1.31	3.32	1.39	4.16	1.42	4.81	1.86	6.73	2.10	7.35	2.18	8.22	2.47
25.0	2.66	1.32	3.27	1.39	4.13	1.43	4.78	1.87	6.68	2.11	7.30	2.19	8.05	2.46
27.0	2.59	1.33	3.20	1.41	4.04	1.45	4.69	1.88	6.58	2.14	7.21	2.20	7.71	2.43

Heating: 208-230V 60Hz  
Temp.: Fahrenheit/TC: kBtu/h / PI: kW

Indoor Temperature	Outdoor temperature [°F WB]													
	5.0		14.0		23.0		32.0		43.0		50.0		64.4	
EWB	TC	PI	TC	PI	TC	PI	TC	PI	TC	PI	TC	PI	TC	PI
59.0	10.34	1.25	12.46	1.31	15.42	1.36	17.67	1.78	24.41	2.03	26.55	2.09	33.21	2.59
70.0	9.76	1.29	11.82	1.35	14.75	1.39	16.98	1.83	23.60	2.07	25.75	2.14	30.33	2.53
71.6	9.47	1.31	11.58	1.37	14.48	1.41	16.69	1.84	23.26	2.08	25.42	2.16	29.18	2.50
75.2	9.21	1.31	11.32	1.39	14.18	1.42	16.40	1.86	22.95	2.10	25.09	2.18	28.03	2.47
77.0	9.08	1.32	11.16	1.39	14.08	1.43	16.31	1.87	22.79	2.11	24.90	2.19	27.46	2.46
80.6	8.84	1.33	10.93	1.41	13.78	1.45	16.01	1.88	22.45	2.14	24.60	2.20	26.31	2.43

Symbols

- AFR Air Flow rate (m<sup>3</sup>/min)
- BPF Bypass factor (°C) / (°F)
- EWB Entering Wet Bulb (°C) / (°F)
- EDB Entering Dry Bulb (kW) / (kBtu/h)
- TC Total Capacity (kW) / (kBtu/h)
- SHC Sensible Heat Capacity (kW)
- PI Power Input (kW)

NOTES:

- Shows nominal (rated) capacities and power input
- TC, SHC and PI must be calculated by interpolation using the figures in the above table
- Capacities are based on the following condition:  
Corresponding refrigerant piping length :25ft  
Level difference :0ft

Capacity correction factor by the length of refrigerant piping

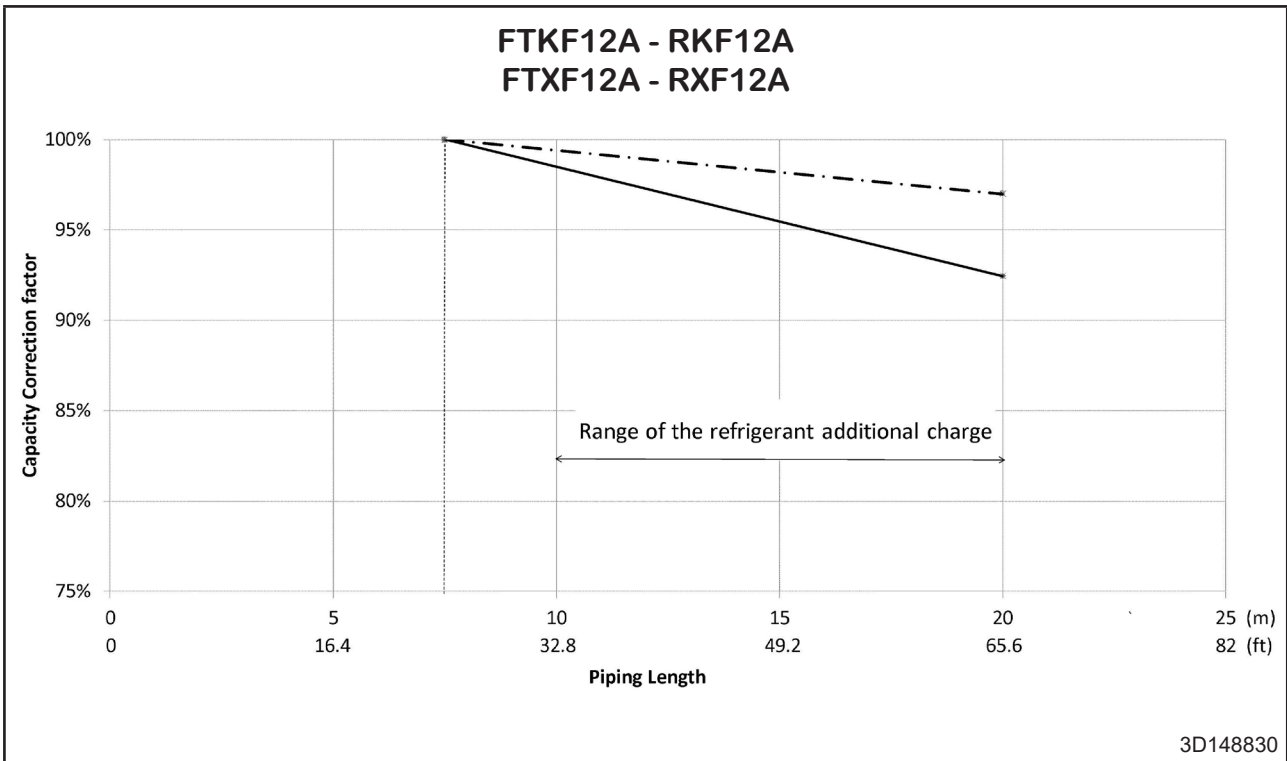
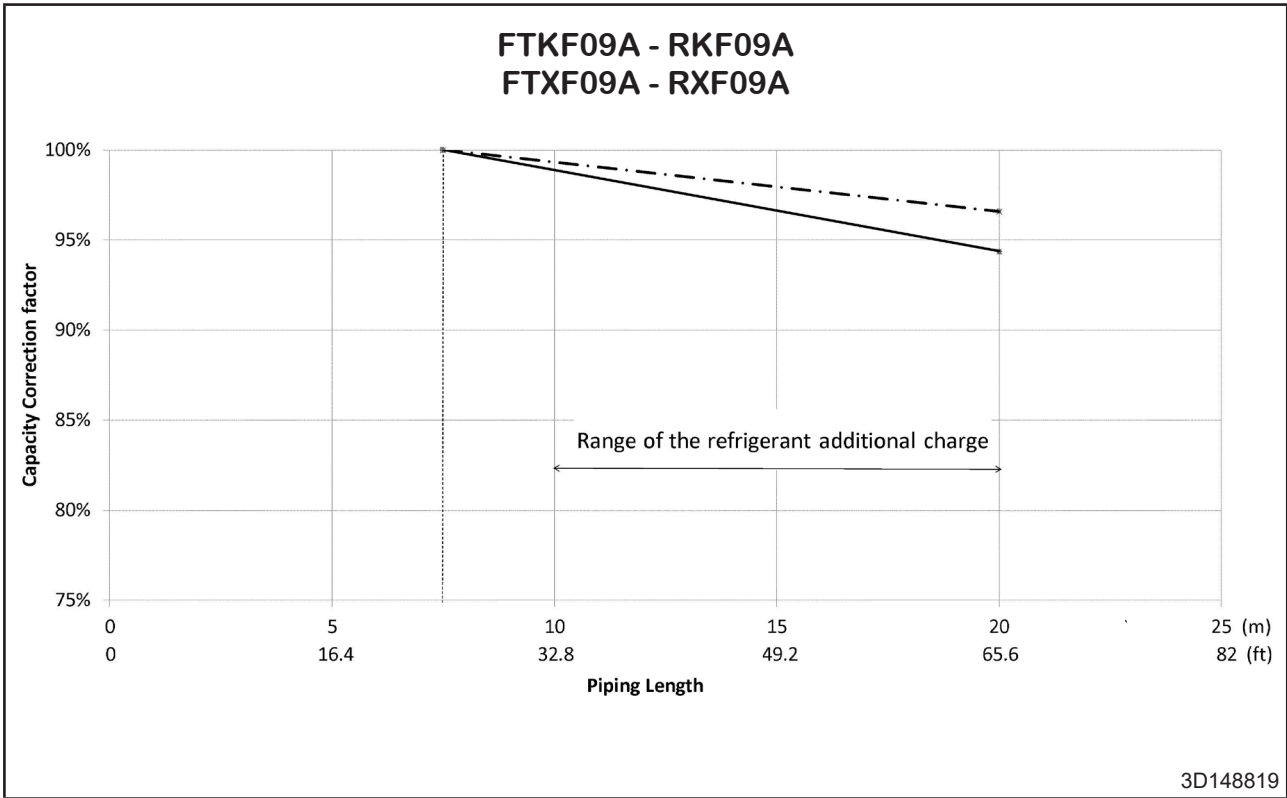

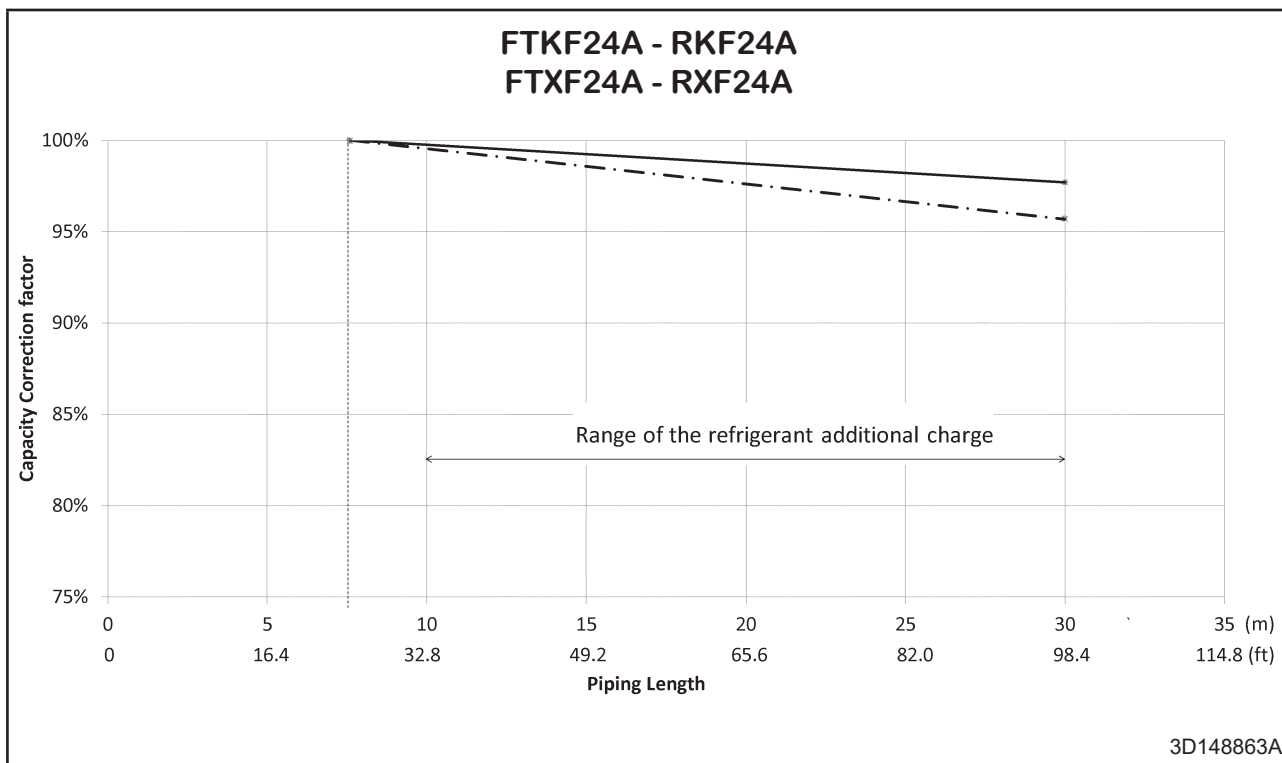
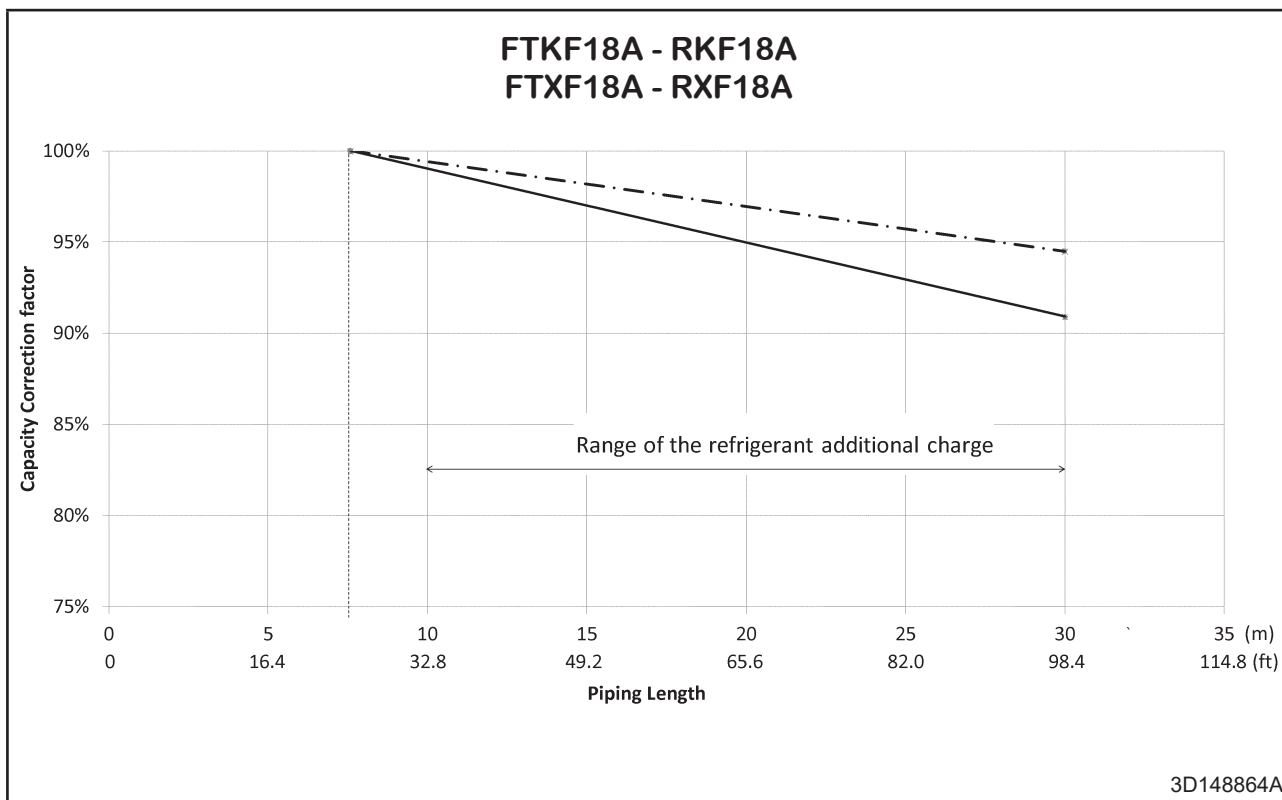

**Notes:**

- 1.----- represents the capacity correction factor for the capacity when additional refrigerant of the proper quantity is charged.
- 2.The correction ratio remains the same whether the outdoor unit is to be installed above or below the unit.
- 3.Calculation method for capacity  
Capacity = capacity obtained from engineering data x capacity correction factor
- 4.The actual unit piping length shall not exceed the maximum piping length shown on the table.

# Operation Limit

## Cooling Only

Model : RKF09/12A

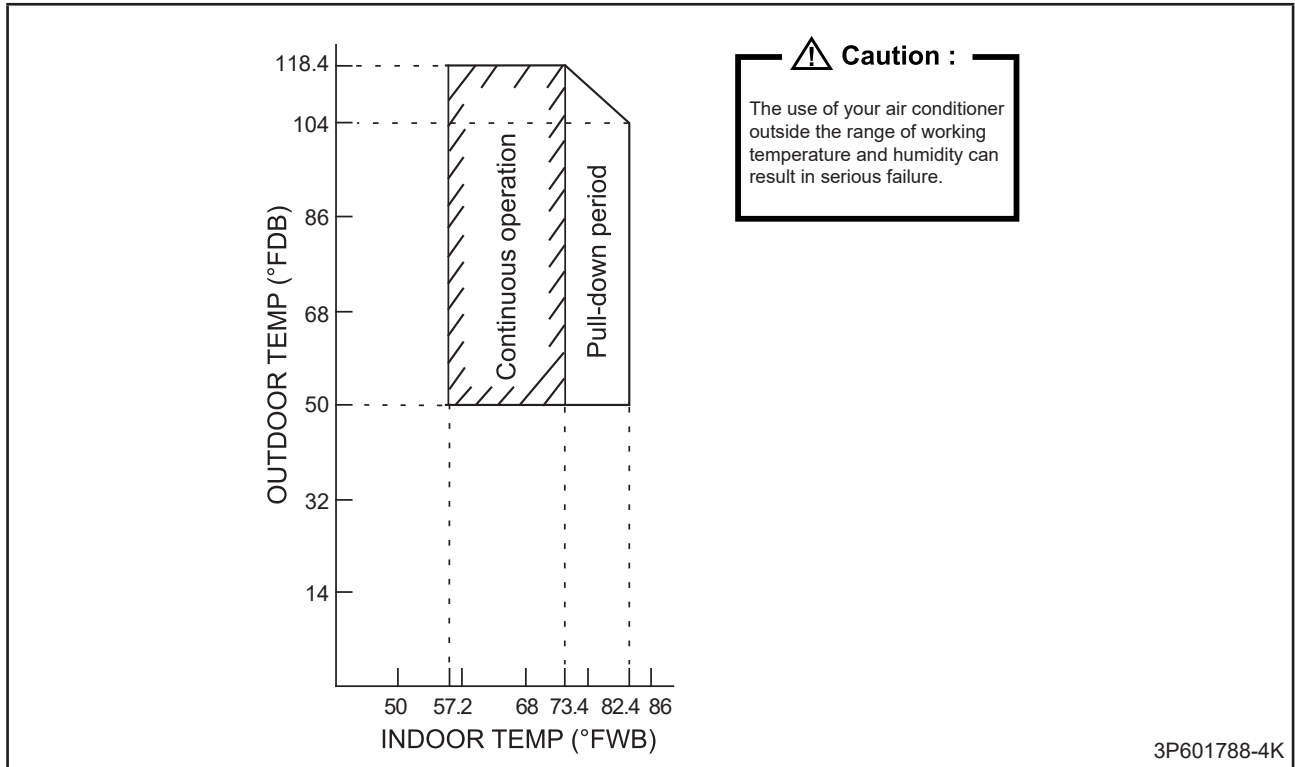

Model : RKF18/24A

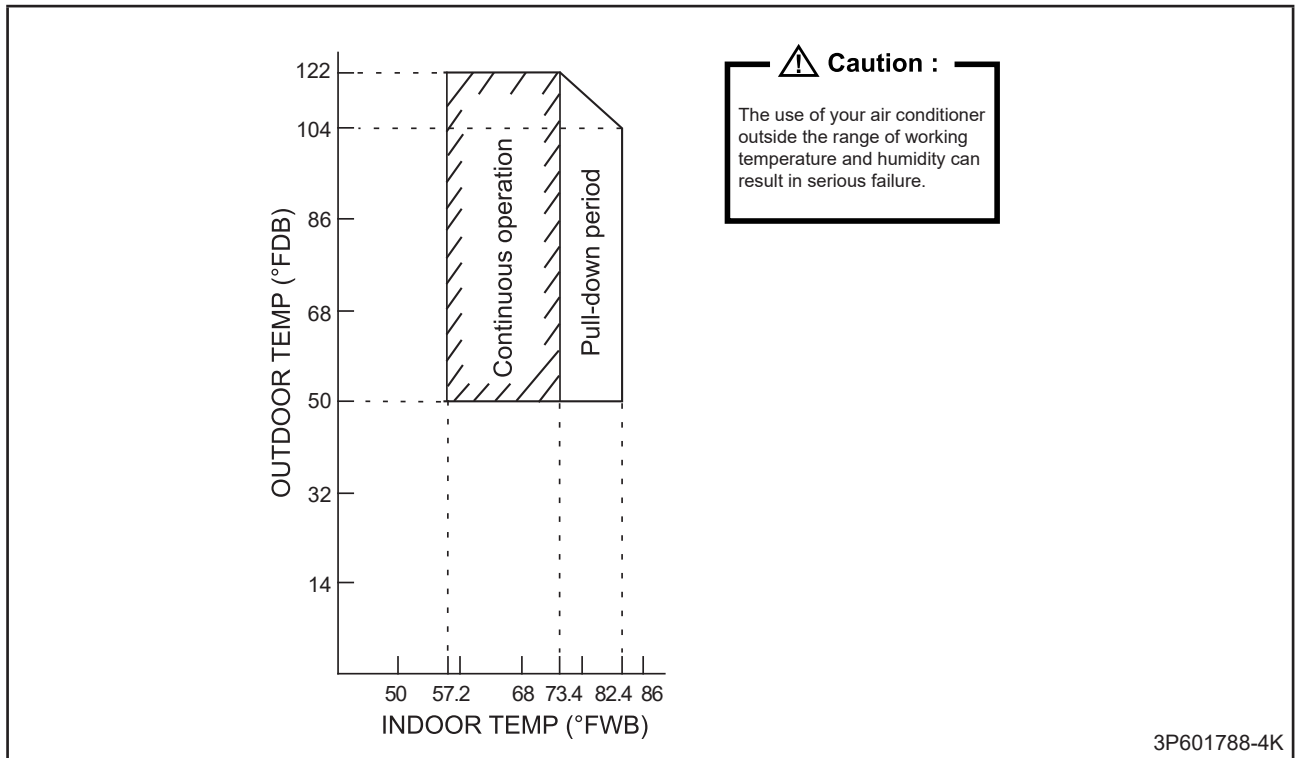



## Heatpump

Model : RXF09/12A

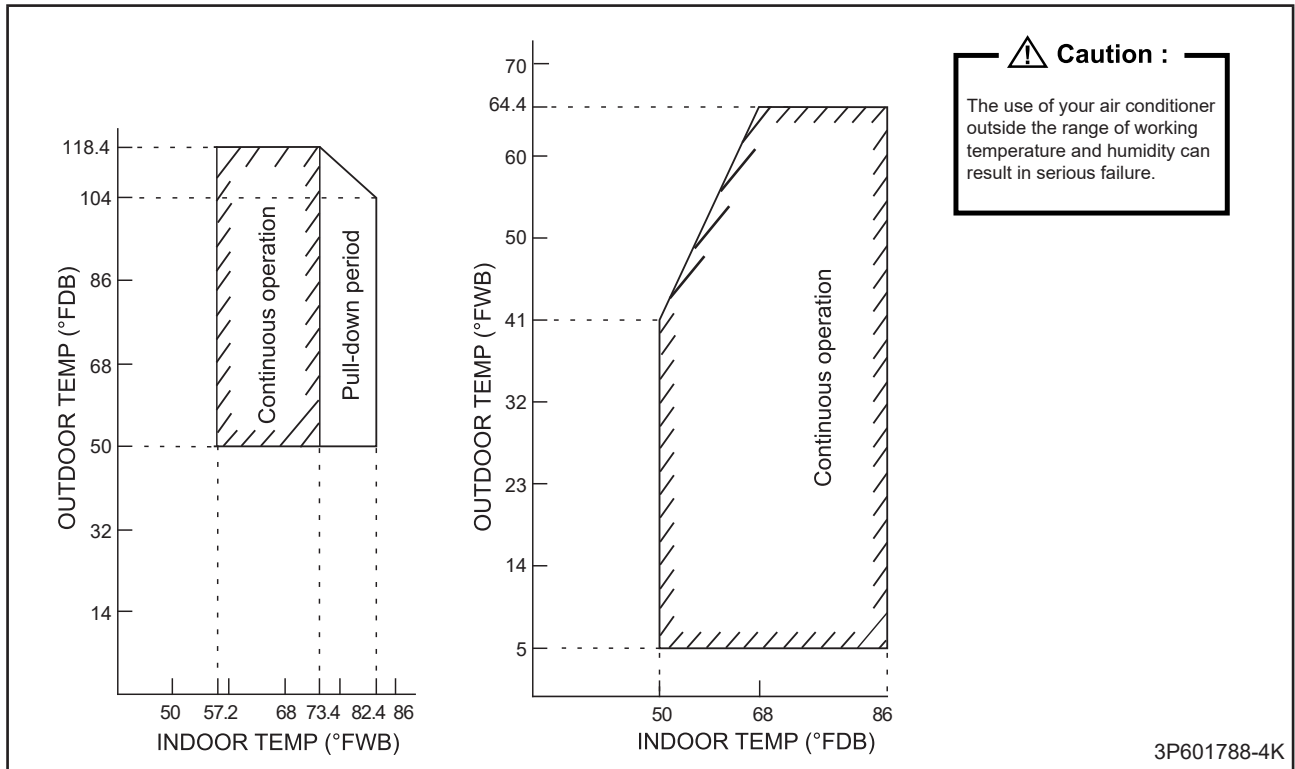

Model : RXF18/24A

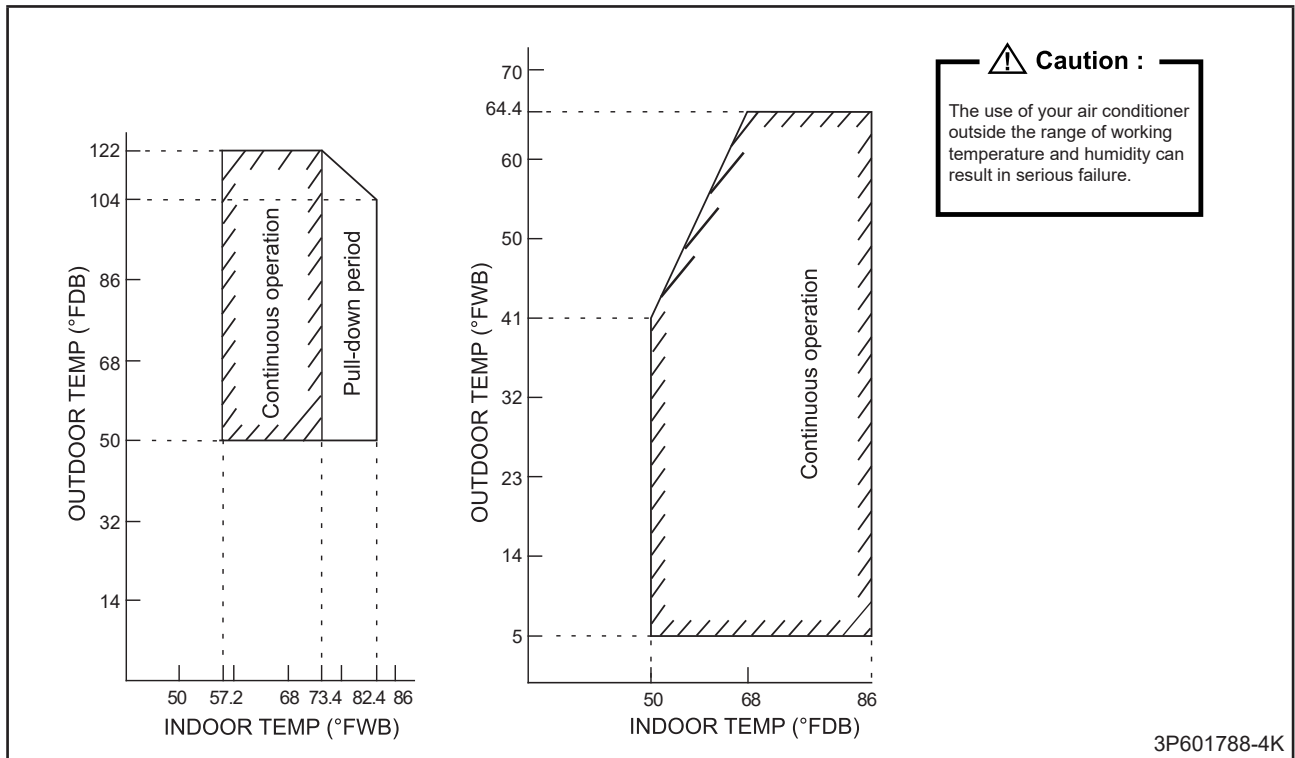

# Sound Level

## Measuring Location

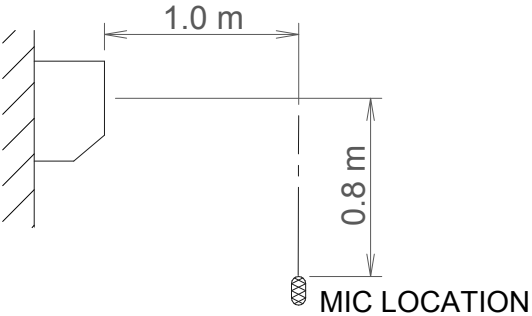
Model	Measuring Location
<p>FTKF/FTXF09A                      FTKF/FTXF12A                      FTKF/FTXF18A                      FTKF/FTXF24A</p>	 <p>The diagram illustrates the microphone placement for sound level measurement. A device is shown on the left, with a microphone located 1.0 m horizontally and 0.8 m vertically from the device's center. The microphone is labeled "MIC LOCATION".</p>

**Notes:**

1. Operation sound is measured in an anechoic chamber.

## Cooling Only

### Sound Pressure Level

Model	Speed	1/1 Octave A-weighted Sound Pressure Level (dB, ref 20 $\mu$ Pa)								Overall (dBA)	Noise Criteria
		63Hz	125Hz	250Hz	500Hz	1kHz	2kHz	4kHz	8kHz		
FTKF09A	High	55	44	42	40	40	36	27	16	44	39
	Med	46	36	37	34	33	27	18	11	37	32
	Low	38	29	31	28	26	19	12	10	30	24
	Quiet	25	19	20	16	13	10	8	9	19	0

### NC Curve

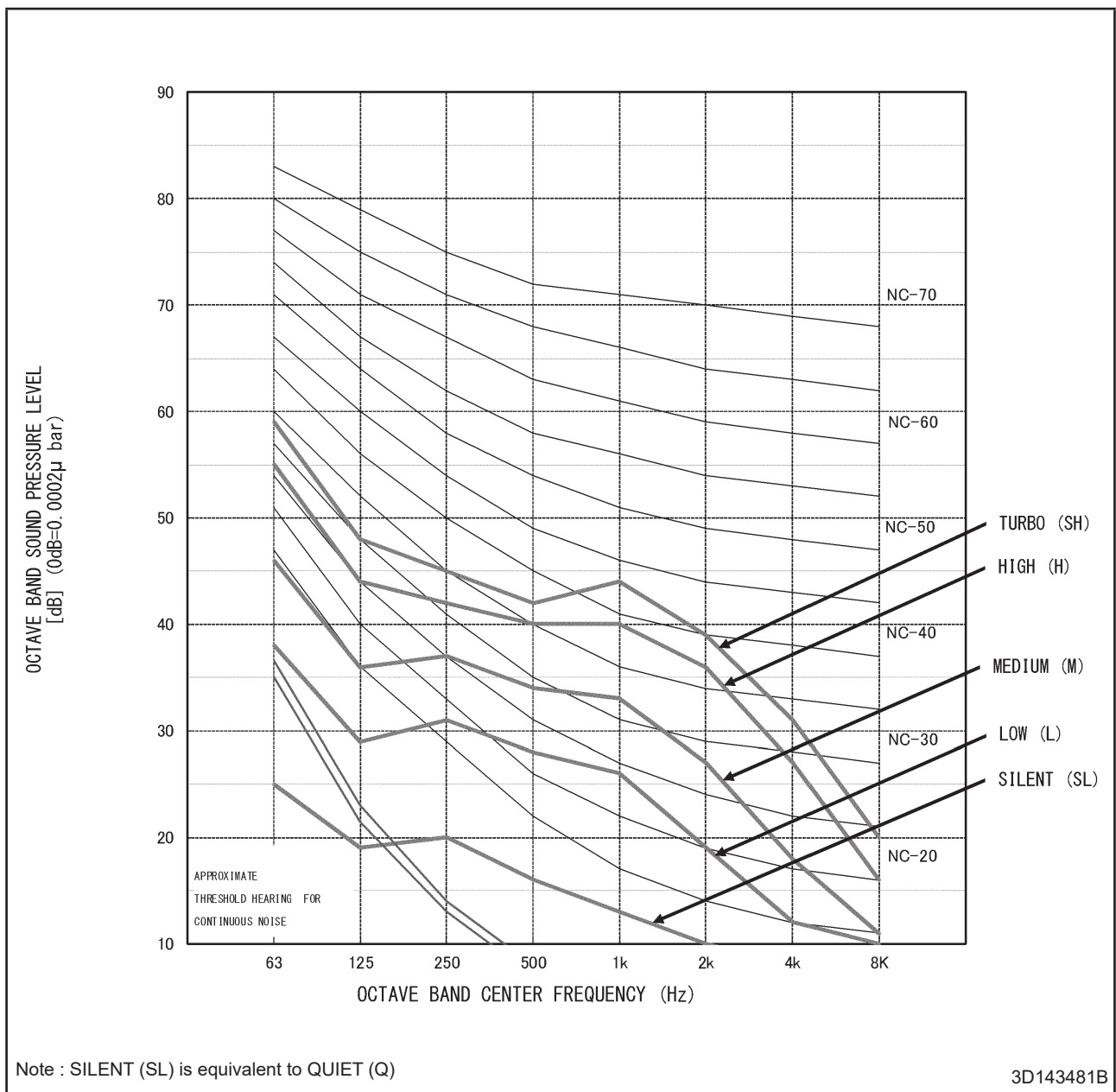

### Sound Pressure Level

Model	Speed	1/1 Octave A-weighted Sound Pressure Level (dB, ref 20μPa)								Overall (dBA)	Noise Criteria
		63Hz	125Hz	250Hz	500Hz	1kHz	2kHz	4kHz	8kHz		
FTKF12A	High	46	37	43	41	44	38	30	20	46	43
	Med	36	31	37	35	35	30	20	13	38	34
	Low	28	25	32	31	29	22	15	12	32	28
	Quiet	17	19	18	16	13	11	10	9	19	0

### NC Curve

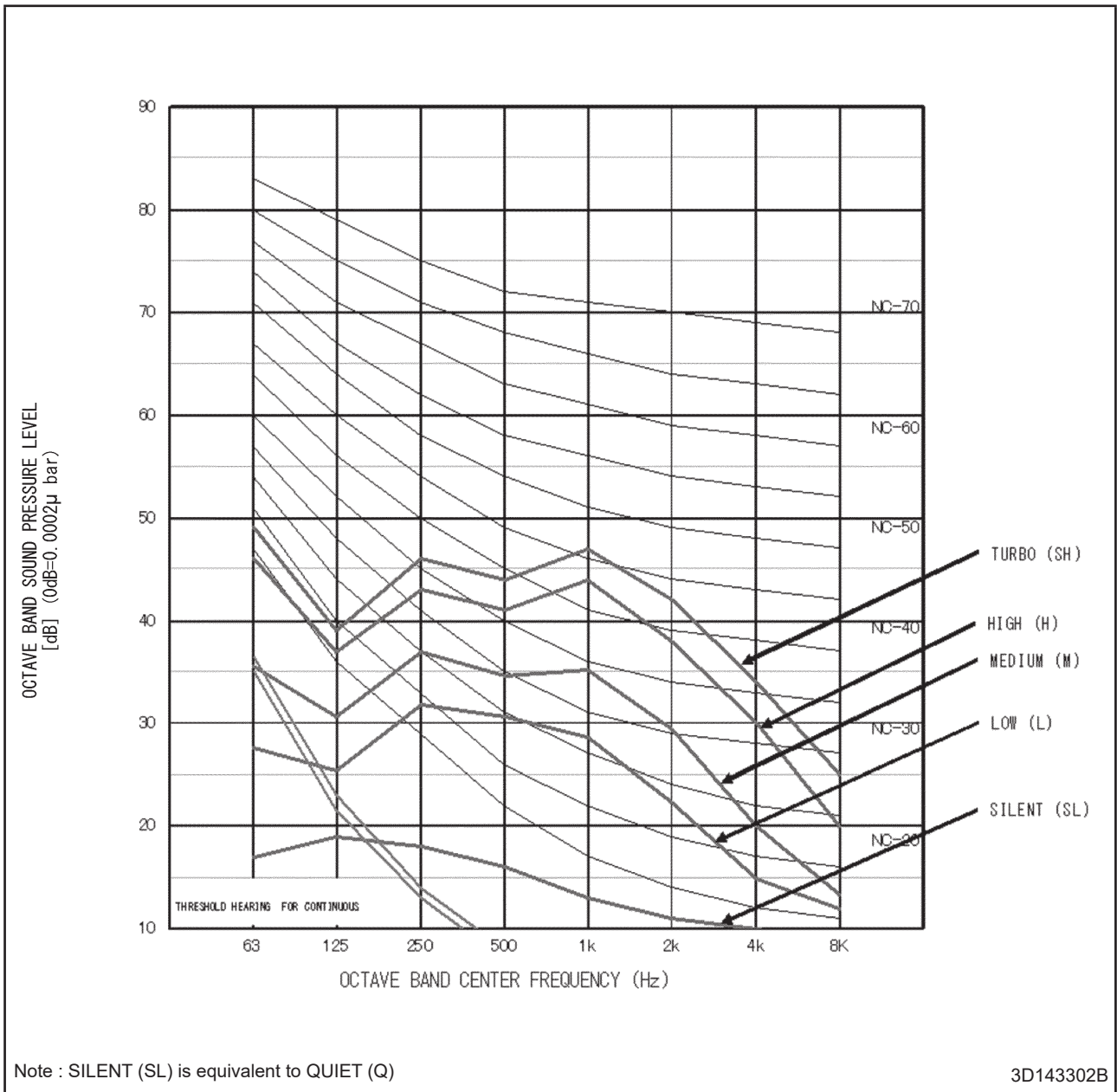

### Sound Pressure Level

Model	Speed	1/1 Octave A-weighted Sound Pressure Level (dB, ref 20μPa)								Overall (dBA)	Noise Criteria
		63Hz	125Hz	250Hz	500Hz	1kHz	2kHz	4kHz	8kHz		
FTKF18A	High	52	42	46	44	45	43	35	25	49	44
	Med	42	36	42	40	40	37	29	18	44	39
	Low	35	31	38	35	34	31	21	13	38	33
	Quiet	30	28	34	31	28	23	13	10	33	26

### NC Curve

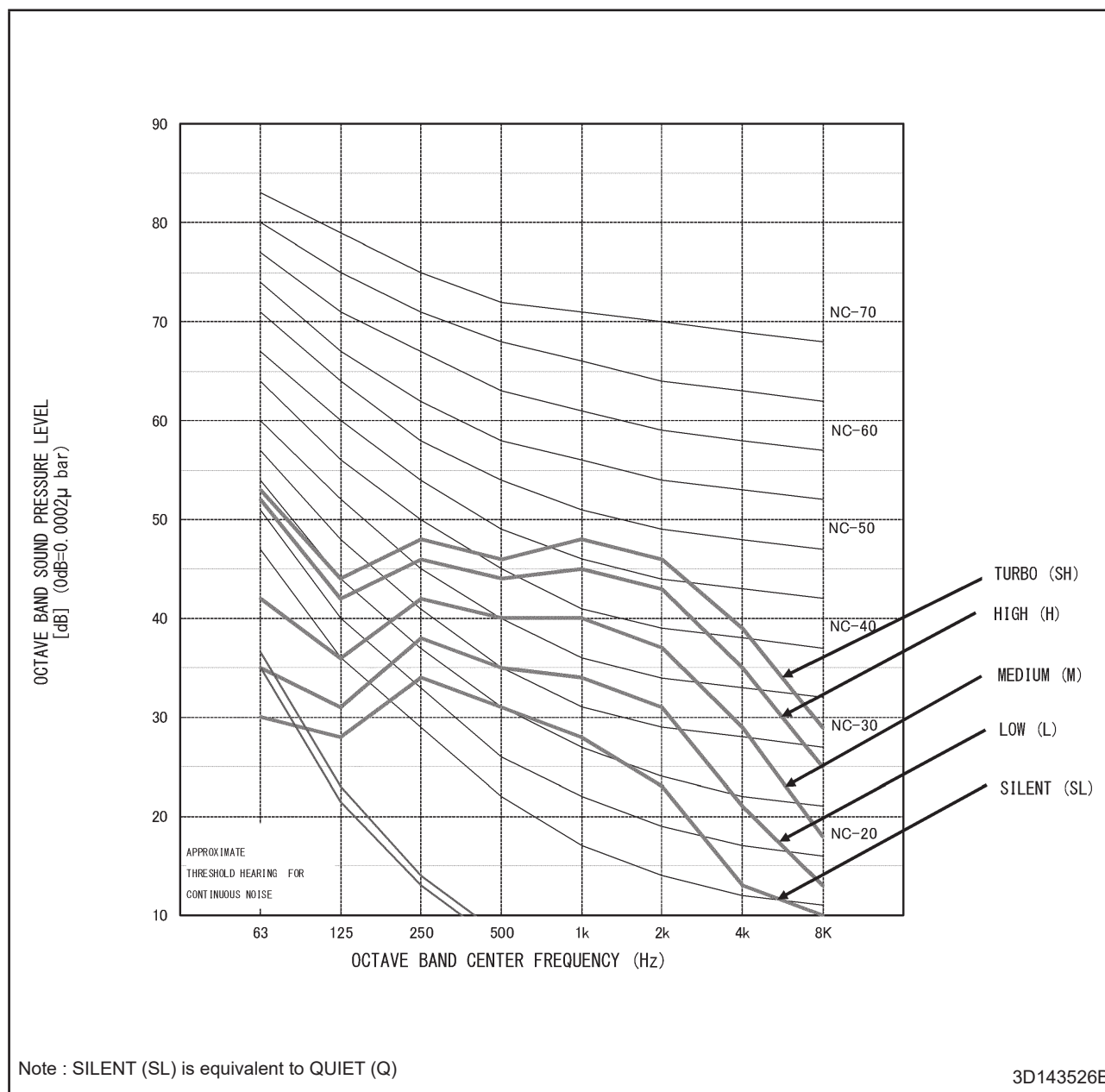

### Sound Pressure Level

Model	Speed	1/1 Octave A-weighted Sound Pressure Level (dB, ref 20μPa)								Overall (dBA)	Noise Criteria
		63Hz	125Hz	250Hz	500Hz	1kHz	2kHz	4kHz	8kHz		
FTKF24A	High	57	47	52	48	48	46	39	29	53	47
	Med	47	39	43	41	40	38	30	20	45	39
	Low	38	34	38	36	34	33	23	17	39	34
	Quiet	34	29	36	31	29	23	14	12	34	28

### NC Curve

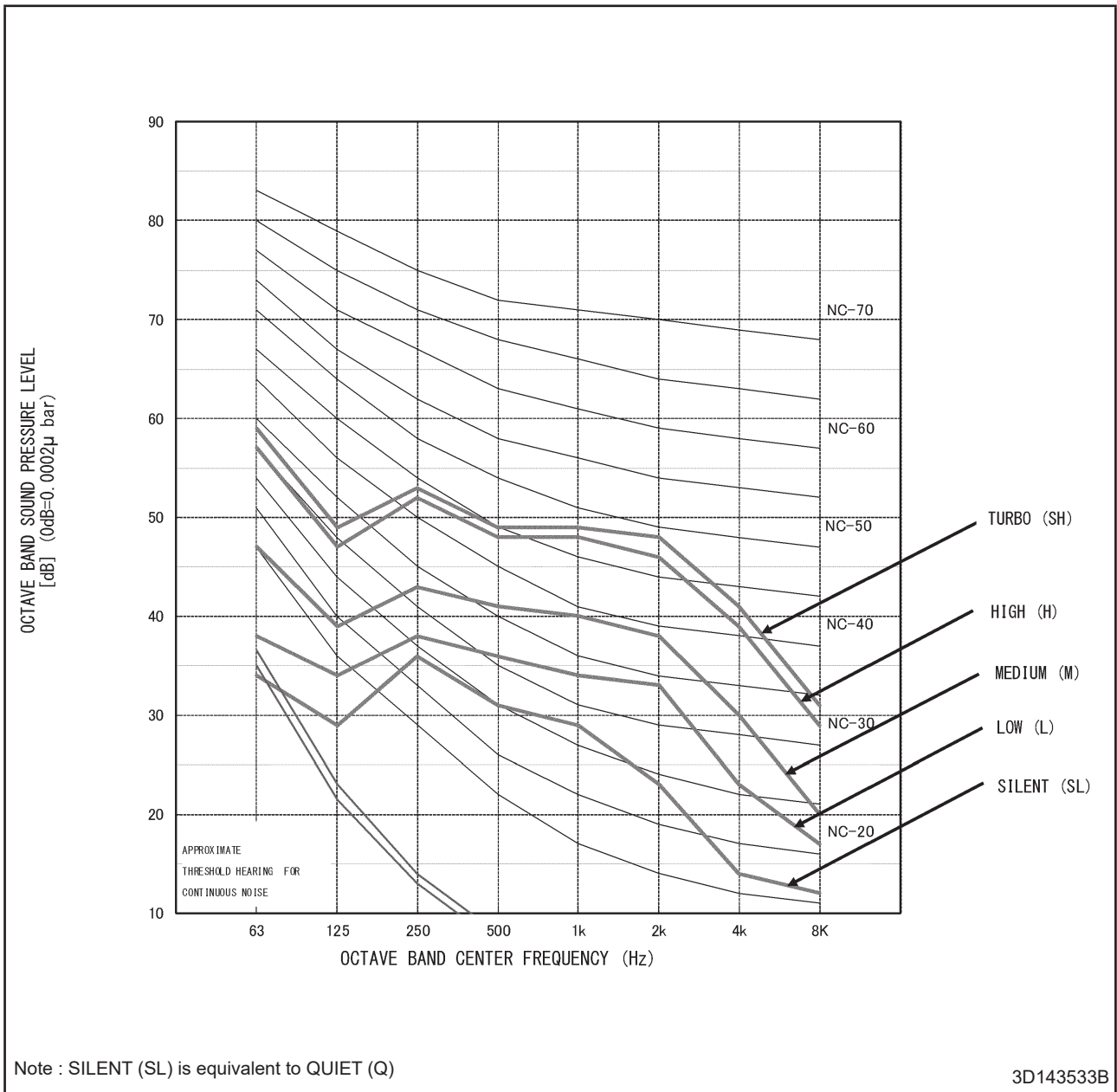

# Heatpump

## Sound Pressure Level

Model	Speed	1/1 Octave A-weighted Sound Pressure Level (dB, ref 20μPa)								Overall (dBA)	Noise Criteria
		63Hz	125Hz	250Hz	500Hz	1kHz	2kHz	4kHz	8kHz		
FTXF09A (Cooling)	High	55	44	42	40	40	36	27	16	44	39
	Med	46	36	37	34	33	27	18	11	37	32
	Low	38	29	31	28	26	19	12	10	30	24
	Quiet	25	19	20	16	13	10	8	9	19	0

## NC Curve

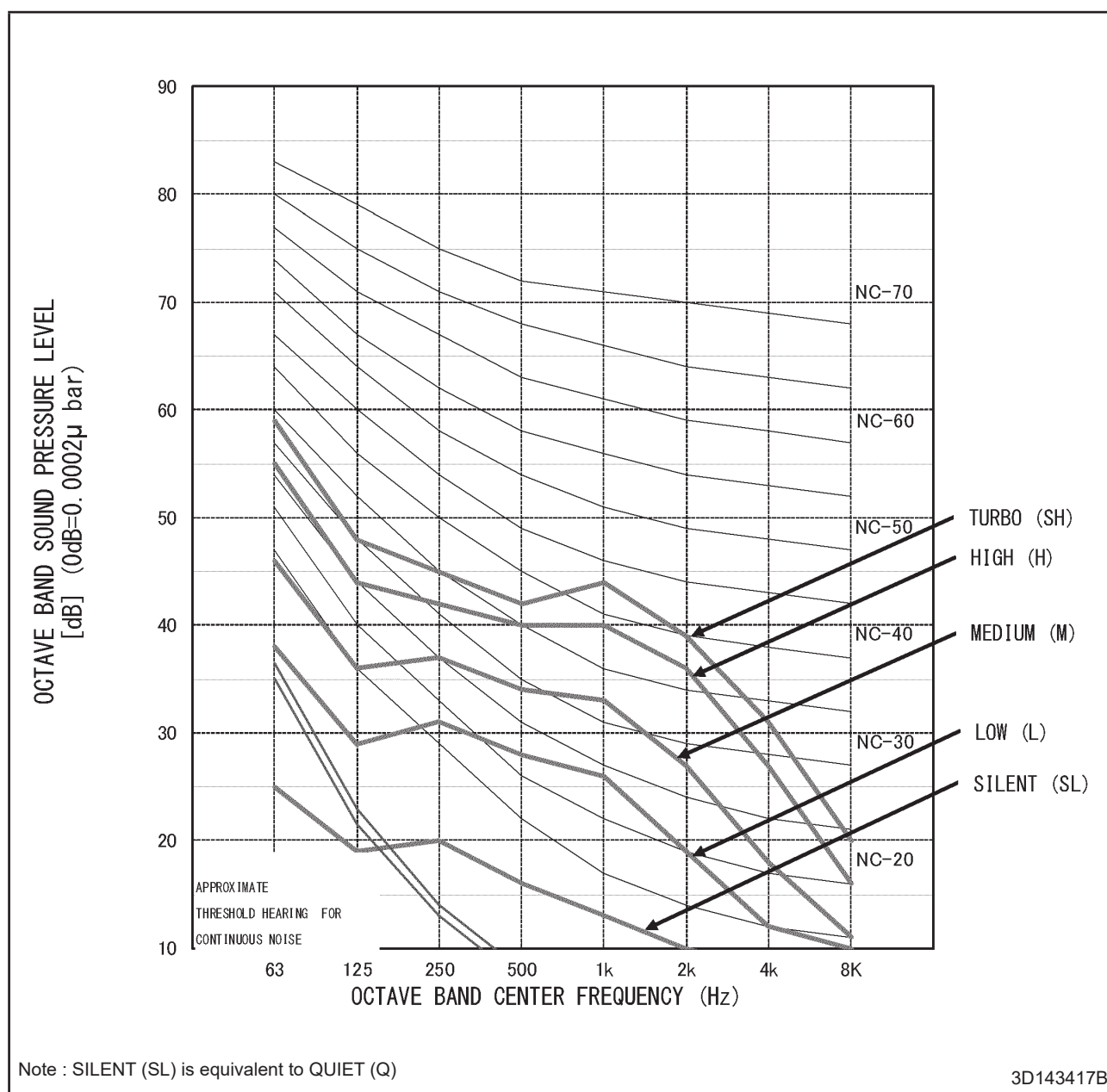

### Sound Pressure Level

Model	Speed	1/1 Octave A-weighted Sound Pressure Level (dB, ref 20μPa)								Overall (dBA)	Noise Criteria
		63Hz	125Hz	250Hz	500Hz	1kHz	2kHz	4kHz	8kHz		
FTXF09A (Heating)	High	50	38	40	38	41	35	26	15	43	40
	Med	37	30	38	34	32	25	14	12	36	31
	Low	32	25	34	28	25	16	12	10	30	23
	Quiet	23	21	29	23	19	11	11	9	25	17

### NC Curve

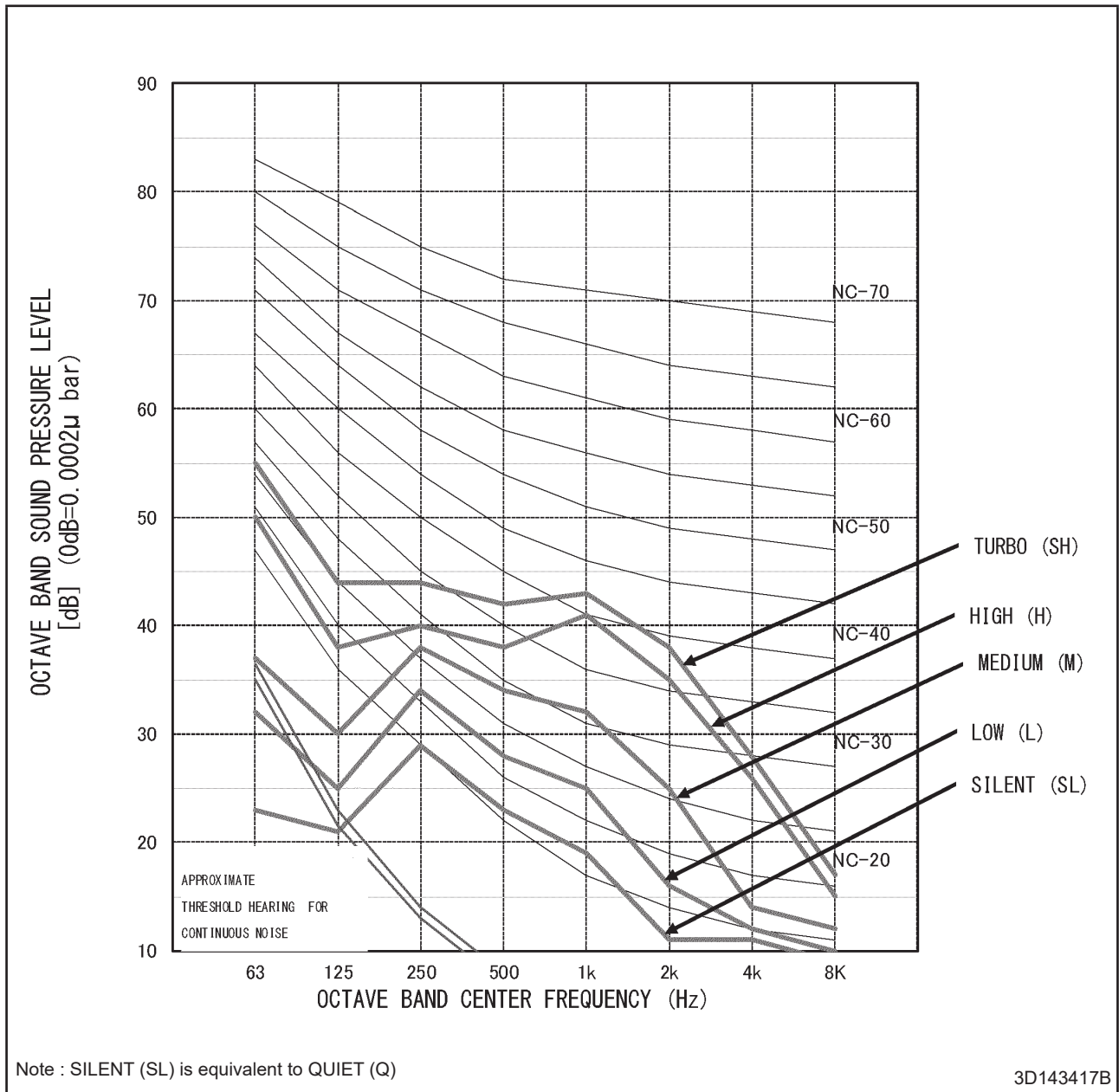



### Sound Pressure Level

Model	Speed	1/1 Octave A-weighted Sound Pressure Level (dB, ref 20μPa)								Overall (dBA)	Noise Criteria
		63Hz	125Hz	250Hz	500Hz	1kHz	2kHz	4kHz	8kHz		
FTXF12A (Cooling)	High	46	37	43	41	44	38	30	20	46	43
	Med	36	31	37	35	35	30	20	13	38	34
	Low	28	25	32	31	29	22	15	12	32	28
	Quiet	17	19	18	16	13	11	10	9	19	0

### NC Curve

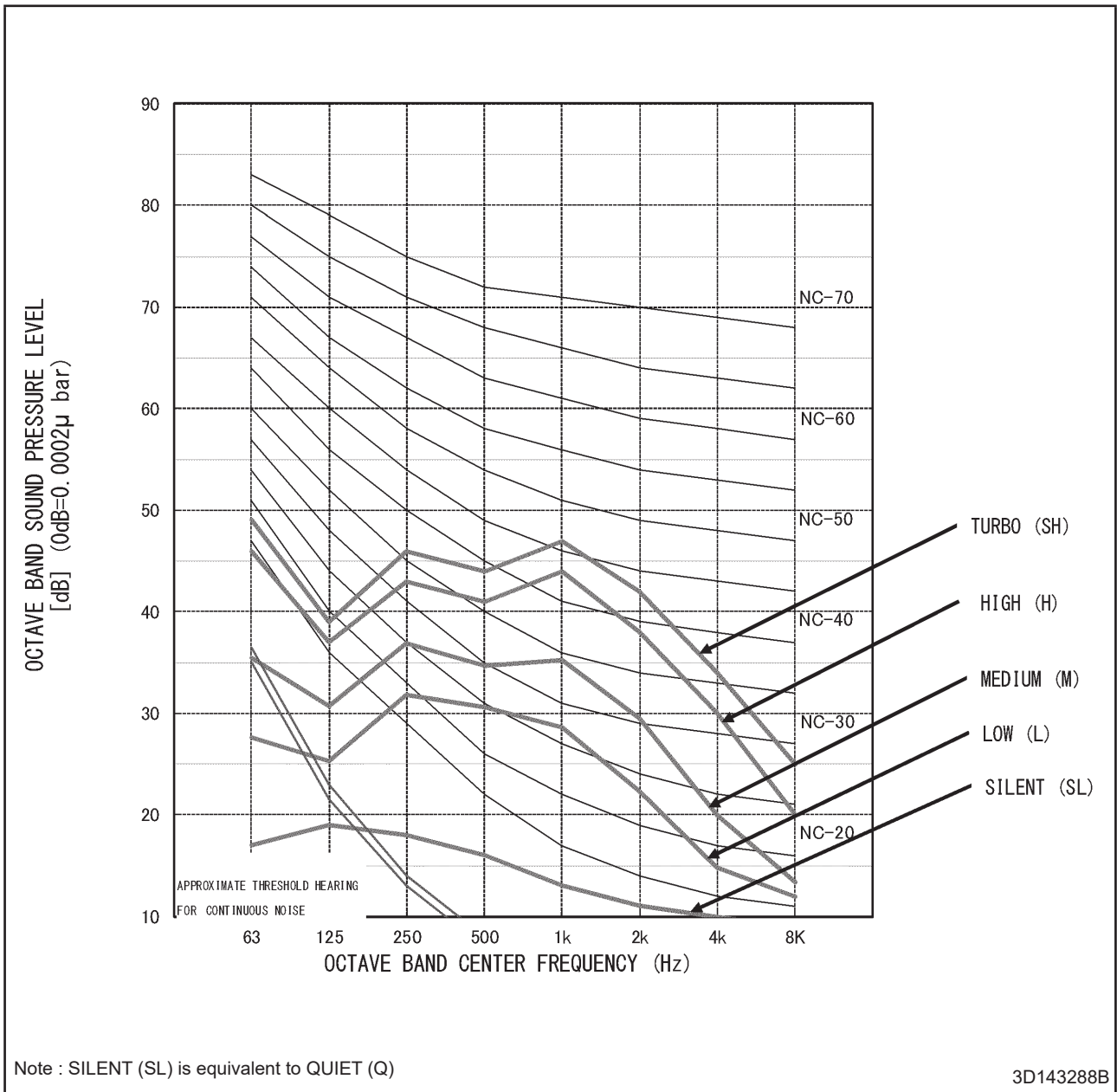

### Sound Pressure Level

Model	Speed	1/1 Octave A-weighted Sound Pressure Level (dB, ref 20μPa)								Overall (dBA)	Noise Criteria
		63Hz	125Hz	250Hz	500Hz	1kHz	2kHz	4kHz	8kHz		
FTXF12A (Heating)	High	49	38	42	40	43	36	25	14	45	42
	Med	40	30	38	34	33	25	14	11	37	32
	Low	30	25	33	29	26	17	12	11	31	24
	Quiet	28	24	29	25	20	12	10	10	26	19

### NC Curve

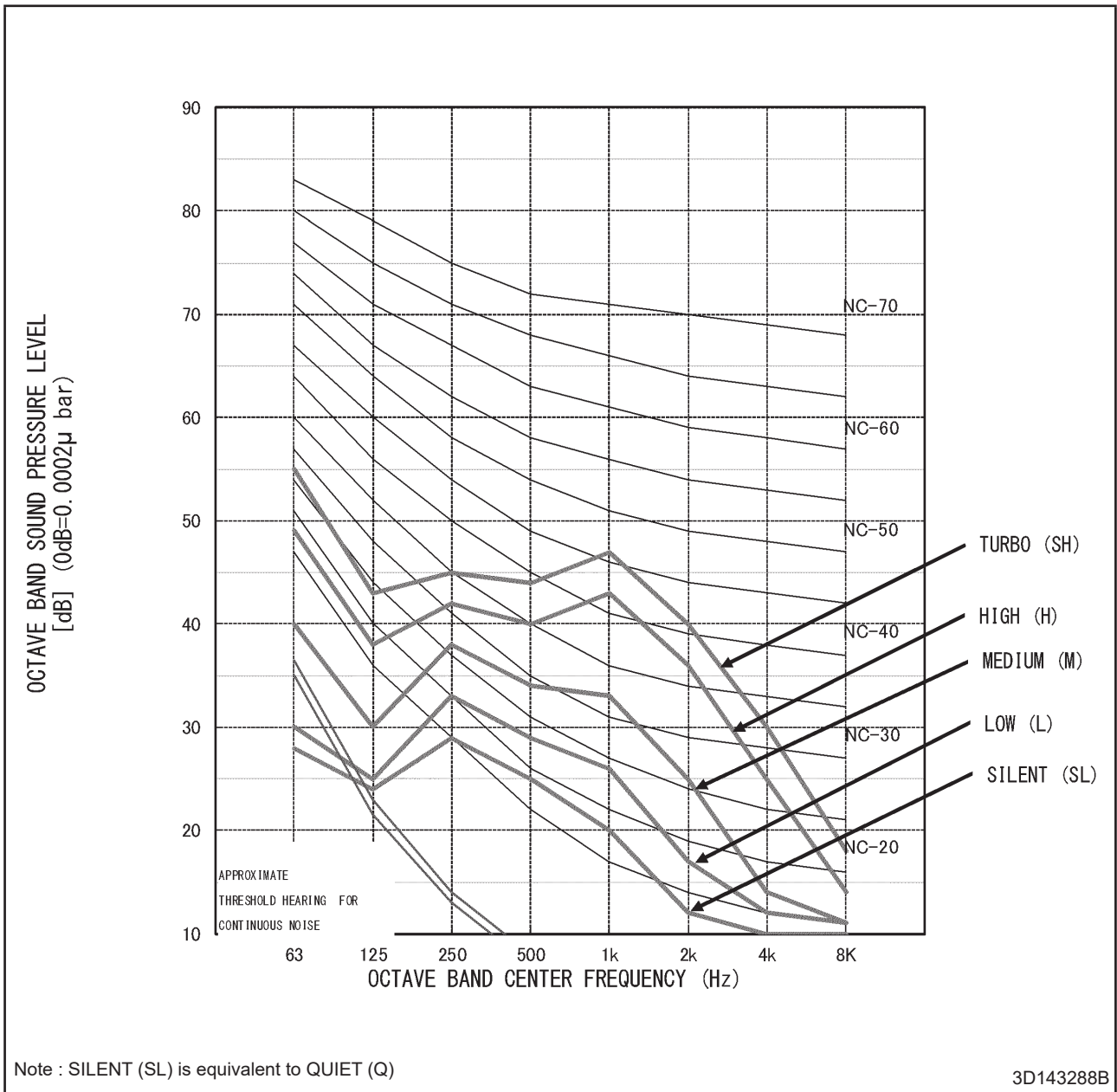

**Sound Pressure Level**

Model	Speed	1/1 Octave A-weighted Sound Pressure Level (dB, ref 20µPa)								Overall (dBA)	Noise Criteria
		63Hz	125Hz	250Hz	500Hz	1kHz	2kHz	4kHz	8kHz		
FTXF18A (Cooling)	High	52	42	46	44	45	43	35	25	49	44
	Med	42	36	42	40	40	37	29	18	44	39
	Low	35	31	38	35	34	31	21	13	38	33
	Quiet	30	28	34	31	28	23	13	10	33	26

**NC Curve**

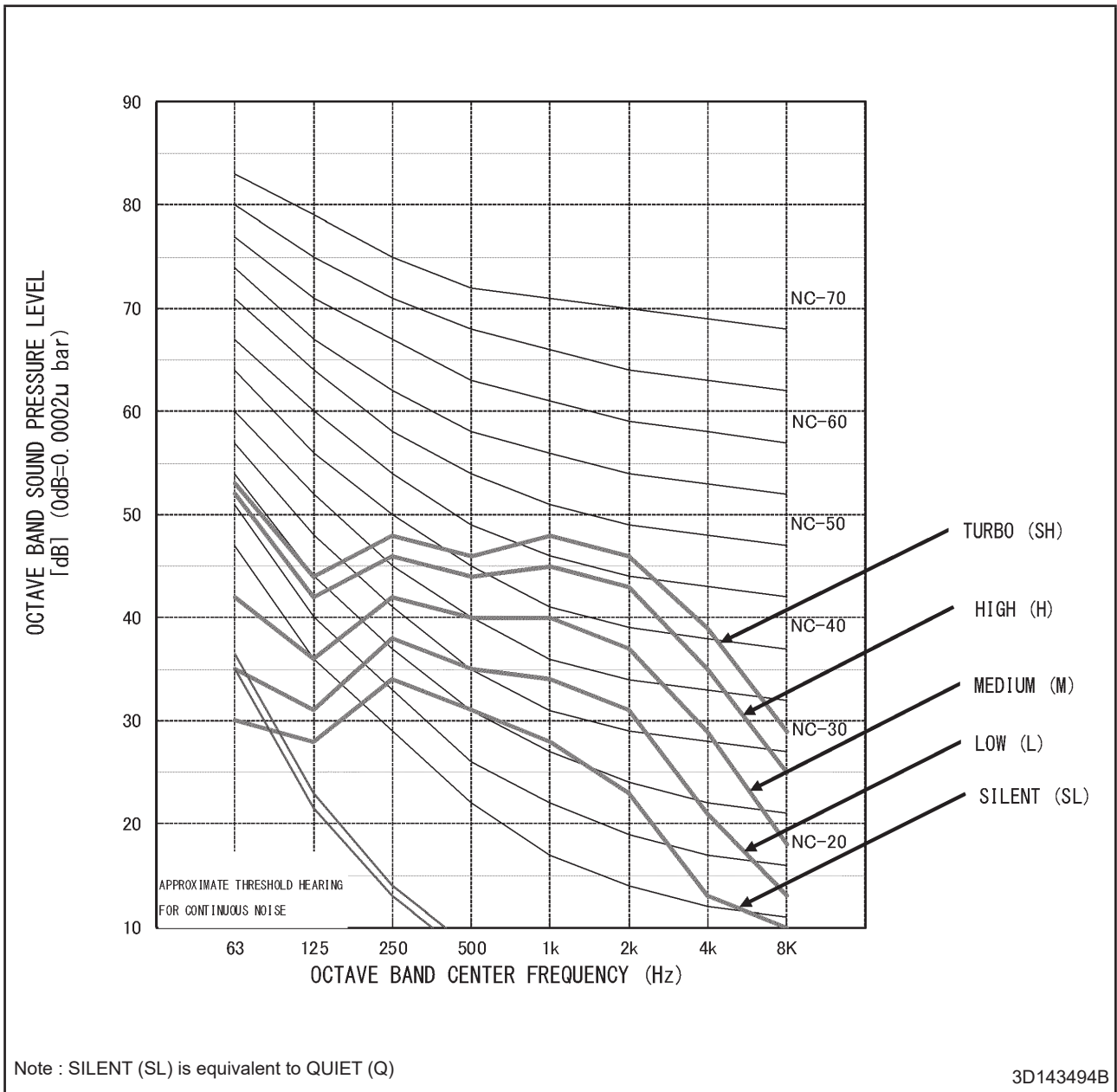

### Sound Pressure Level

Model	Speed	1/1 Octave A-weighted Sound Pressure Level (dB, ref 20μPa)								Overall (dBA)	Noise Criteria
		63Hz	125Hz	250Hz	500Hz	1kHz	2kHz	4kHz	8kHz		
FTXF18A (Heating)	High	56	44	47	46	45	42	33	18	49	44
	Med	46	36	40	38	39	35	25	12	42	38
	Low	38	31	38	35	32	26	15	11	37	31
	Quiet	36	28	35	31	29	22	11	10	33	28

### NC Curve

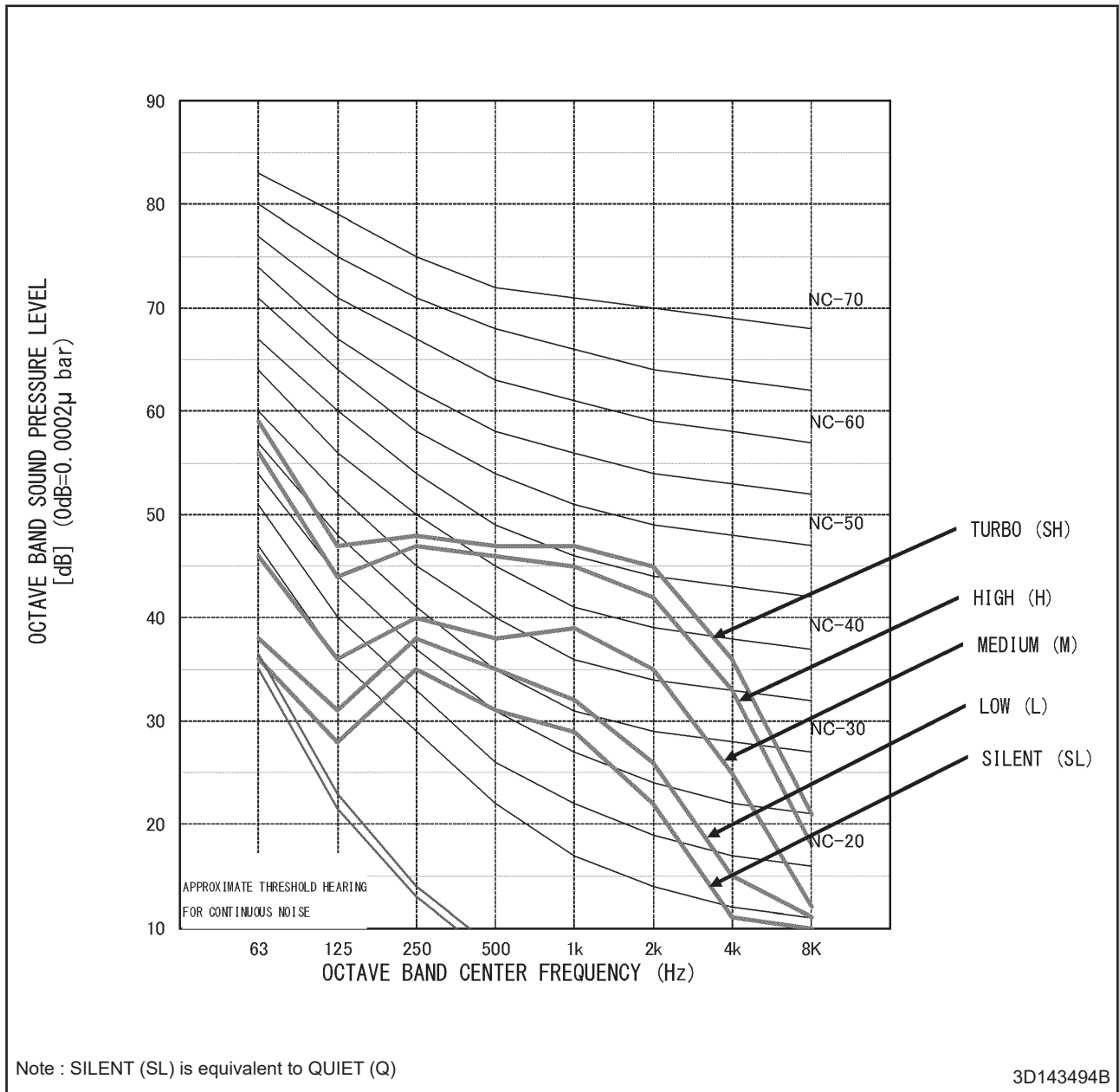

### Sound Pressure Level

Model	Speed	1/1 Octave A-weighted Sound Pressure Level (dB, ref 20μPa)								Overall (dBA)	Noise Criteria
		63Hz	125Hz	250Hz	500Hz	1kHz	2kHz	4kHz	8kHz		
FTXF24A (Cooling)	High	56	46	50	49	48	46	39	29	53	47
	Med	47	39	43	41	40	38	30	20	45	39
	Low	38	34	38	36	34	33	23	17	39	34
	Quiet	34	29	36	31	29	23	14	12	34	28

### NC Curve

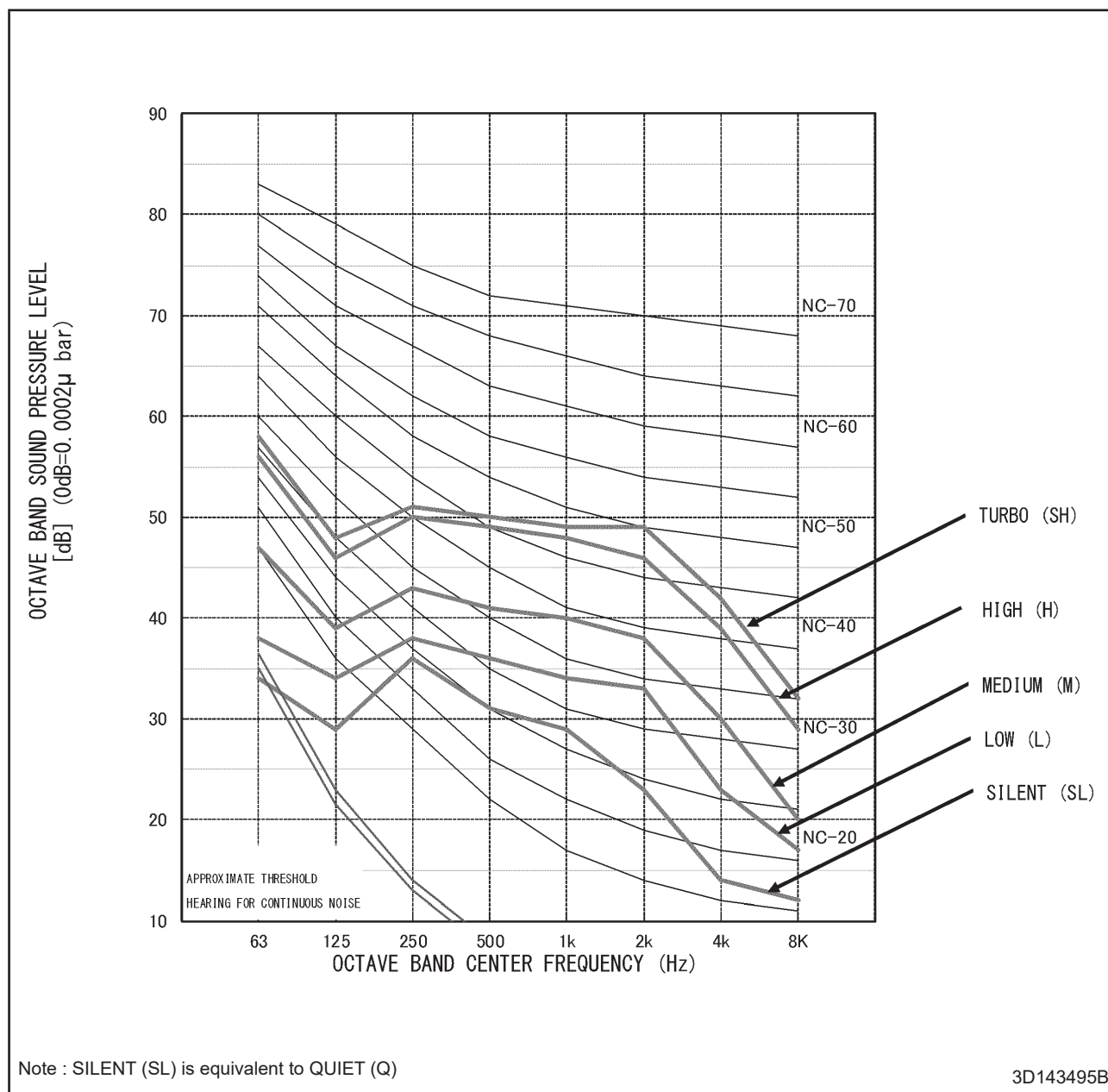

### Sound Pressure Level

Model	Speed	1/1 Octave A-weighted Sound Pressure Level (dB, ref 20μPa)								Overall (dBA)	Noise Criteria
		63Hz	125Hz	250Hz	500Hz	1kHz	2kHz	4kHz	8kHz		
FTXF24A (Heating)	High	63	51	52	50	47	46	34	22	53	47
	Med	50	41	43	40	39	35	24	15	43	38
	Low	41	33	40	36	33	27	17	12	38	32
	Quiet	37	30	37	32	29	23	12	11	34	28

### NC Curve

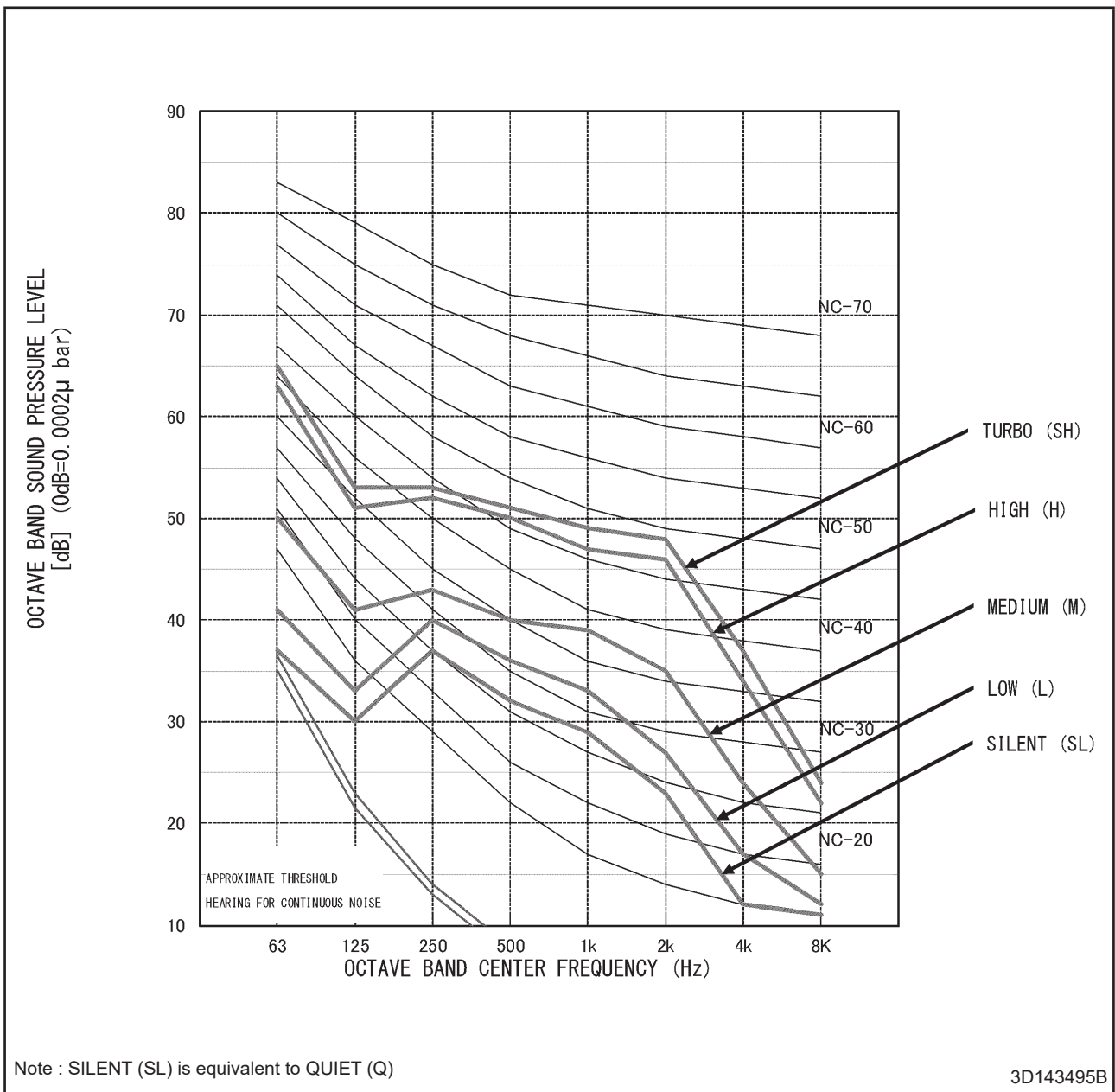

# Electric Characteristic

Unit Combination		Power Supply				COMP		OFM		IFM	
Indoor Unit	Outdoor Unit	Hz-Volts	Voltage Range	MCA	MOP	RHz	A	kW	MOC	kW	MOC
FTKF09A	RKF09A	60Hz-208V	MAX. 60Hz 253V MIN. 60Hz 187V	9.10	15	44	6.05	0.026	0.61	0.022	0.35
		60Hz-230V									
FTKF12A	RKF12A	60Hz-208V	MAX. 60Hz 253V MIN. 60Hz 187V	9.15	15	65	5.99	0.026	0.61	0.022	0.40
		60Hz-230V									
FTKF18A	RKF18A	60Hz-208V	MAX. 60Hz 253V MIN. 60Hz 187V	14.23	20	64	9.09	0.055	1.30	0.039	0.55
		60Hz-230V									
FTKF24A	RKF24A	60Hz-208V	MAX. 60Hz 253V MIN. 60Hz 187V	14.23	20	79	9.09	0.055	1.30	0.039	0.55
		60Hz-230V									
FTXF09A	RXF09A	60Hz-208V	MAX. 60Hz 253V MIN. 60Hz 187V	9.30	15	54	6.05	0.026	0.61	0.022	0.35
		60Hz-230V									
FTXF12A	RXF12A	60Hz-208V	MAX. 60Hz 253V MIN. 60Hz 187V	9.36	15	74	5.99	0.026	0.61	0.022	0.40
		60Hz-230V									
FTXF18A	RXF18A	60Hz-208V	MAX. 60Hz 253V MIN. 60Hz 187V	16.34	20	75	9.09	0.055	1.30	0.039	0.55
		60Hz-230V									
FTXF24A	RXF24A	60Hz-208V	MAX. 60Hz 253V MIN. 60Hz 187V	16.34	20	83	9.09	0.055	1.30	0.039	0.55
		60Hz-230V									

**Symbols:**

MCA	: Minimum Circuit Amps (A)
MOP	: Maximum Overcurrent Protection (A)
COMP	: Compressor
RHz	: Rated Operating Frequency (Hz)
A	: Compressor Input Current (A)
OFM	: Outdoor Fan Motor
IFM	: Indoor Fan Motor
kW	: Fan Motor Rated Output (kW)
MOC	: Maximum Operating Current (A)

**Notes:**

1. RHz is the max frequency that comes in cooling operation and heating operation.
2. MOC is the max current that comes in cooling operation and heating operation.
3. Maximum allowable voltage that is unbalance between phases is 2%.
4. Select wire size based on the larger value of MCA.
5. Use circuit breaker instead of fuse

3D148140B

# Accessories List

	Optional Accessories	Model Number
<b>Indoor Unit</b>	Wired Controller	BRC51D61
	Daikin One+ Smart Thermostat	DTST-ONE-ADA-A
	DKN Residential Cloud Wi-Fi Adaptor	AZAI6WSCDKB
<b>Outdoor Unit</b>	Air Directional Change Grille (Class 09/12)	KPW937F4
	Air Directional Change Grille (Class 18/24)	KPW063B4E
	Drain Pan Heater (Class 09/12)	FTDBHMS, KEH067A41E
	Drain Pan Heater (Class 18/24)	KEH063A4EA
	Outdoor Unit Protection Net Grille (Class 09/12)	KKG067A41
	Outdoor Unit Protection Net Grille (Class 18/24)	-



