



EDUS041129

**R-410A**

# Engineering Data

# SPLIT

- Cooling Only / Heat Pump -

**FTXS-L Series**



**INVERTER**

**DAIKIN AC (AMERICAS), INC.**

# Split Type Air Conditioners FTXS-L Series

| Single Split Duct-Free System |            |           |
|-------------------------------|------------|-----------|
| Cooling Only                  | FTXS30LVJU | RKS30LVJU |
|                               | FTXS36LVJU | RKS36LVJU |
| Heat Pump                     | FTXS30LVJU | RXS30LVJU |
|                               | FTXS36LVJU | RXS36LVJU |

|   |    |
|---|----|
| 1. Power Supply .....   | 3  |
| 2. Functions.....   | 4  |
| 3. Specifications .....   | 5  |
| 3.1 Cooling Only .....  | 5  |
| 3.2 Heat Pump .....   | 7  |
| 4. Dimensions .....   | 9  |
| 5. Wiring Diagrams.....   | 10 |
| 6. Piping Diagrams.....   | 11 |
| 6.1 Indoor Unit.....  | 11 |
| 6.2 Outdoor Unit.....   | 12 |
| 7. Capacity Tables .....  | 13 |
| 7.1 Cooling Only.....   | 13 |
| 7.2 Heat Pump .....   | 15 |
| 7.3 Capacity correction factor by the length of refrigerant piping<br>(Reference) ..... | 20 |
| 8. Operation Limit.....   | 21 |
| 9. Sound Level .....  | 22 |
| 9.1 Measuring Location .....  | 22 |
| 9.2 Octave Band Level .....   | 23 |
| 10. Electric Characteristics.....   | 24 |
| 11. Installation Manual .....   | 25 |
| 11.1 Indoor Unit.....   | 25 |
| 11.2 Outdoor Unit.....  | 35 |
| 12. Operation Manual.....   | 47 |
| 13. Optional Accessories .....  | 82 |
| 13.1 Option List .....  | 82 |
| 13.2 <BRC944B2> Wired Remote Controller.....  | 83 |
| 13.3 <KRP413AB1S> Wiring Adaptor for Timer Clock / Remote Controller .....              | 97 |

|   |     |
|---|-----|
| 13.4 <KRP928BB2S> Interface Adaptor for DIII-NET<br>(Residential Air Conditioner) ..... | 101 |
| 13.5 <KPW5E112> Air Direction Adjustment Grille.....                                    | 104 |
| 13.6 <KKP945A4> Drain Plug.....   | 106 |

**Cautions**

1. Air conditioners should not be installed in areas where corrosive gases, such as acid gas or alkaline gas, are produced.
2. If the outdoor unit is to be installed close to the sea shore, direct exposure to the sea breeze should be avoided and choose an outdoor unit with anti-corrosion treatment.

# 1. Power Supply

| Indoor Unit | Outdoor Unit | Power Supply                  |
|-------------|--------------|-------------------------------|
| FTXS30LVJU  | RKS30LVJU    | 1 $\phi$ , 208 - 230 V, 60 Hz |
| FTXS36LVJU  | RKS36LVJU    |                               |
| FTXS30LVJU  | RXS30LVJU    |                               |
| FTXS36LVJU  | RXS36LVJU    |                               |
|             |              |                               |

**Note:**

Power Supply Intake ; Outdoor Unit

## 2. Functions

| Category                  | Functions                                     | FTXS30/36LVJU<br>RKS30/36LVJU |                               | Category                              | Functions   | FTXS30/36LVJU<br>RKS30/36LVJU |                               |
|---------------------------|---|-------------------------------|-------------------------------|---------------------------------------|---|-------------------------------|-------------------------------|
|                           |   | FTXS30/36LVJU<br>RKS30/36LVJU | FTXS30/36LVJU<br>RKS30/36LVJU |                                       |   | FTXS30/36LVJU<br>RKS30/36LVJU | FTXS30/36LVJU<br>RKS30/36LVJU |
| Basic Function            | Inverter (with Inverter Power Control)        | ●                             | ●                             | Health & Clean                        | Air-Purifying Filter  | —                             | —                             |
|                           | Operation Limit for Cooling (°FDB)            | 14 ~ 114.8                    | 14 ~ 114.8                    |                                       | Photocatalytic Deodorizing Filter                               | —                             | —                             |
|                           | Operation Limit for Heating (°FWB)            | —                             | 5 ~ 64.4                      |                                       | Air-Purifying Filter with Photocatalytic Deodorizing Function   | —                             | —                             |
|                           | PAM Control                                   | ●                             | ●                             |                                       | Titanium Apatite Photocatalytic Air-Purifying Filter            | ●                             | ●                             |
| Compressor                | Oval Scroll Compressor                        | —                             | —                             | Timer                                 | Air Filter (Prefilter)  | ●                             | ●                             |
|                           | Swing Compressor                              | ●                             | ●                             |                                       | Wipe-Clean Flat Panel   | ●                             | ●                             |
|                           | Rotary Compressor                             | —                             | —                             |                                       | Washable Grille   | —                             | —                             |
|                           | Reluctance DC Motor                           | ●                             | ●                             |                                       | MOLD PROOF Operation  | —                             | —                             |
| Comfortable Airflow       | Power-Airflow Louver (Horizontal Blade)       | —                             | —                             | Worry Free "Reliability & Durability" | Heating Dry Operation   | —                             | —                             |
|                           | Power-Airflow Dual Louvers                    | ●                             | ●                             |                                       | Good-Sleep Cooling Operation                                    | —                             | —                             |
|                           | Power-Airflow Diffuser                        | —                             | —                             |                                       | WEEKLY TIMER  | ●                             | ●                             |
|                           | Wide-Angle Fins (Vertical Blades)             | ●                             | ●                             |                                       | 24-Hour ON/OFF TIMER  | ●                             | ●                             |
|                           | Vertical Auto-Swing (Up and Down)             | ●                             | ●                             |                                       | NIGHT SET Mode  | ●                             | ●                             |
|                           | Horizontal Auto-Swing (Right and Left)        | ●                             | ●                             |                                       | Auto-Restart (after Power Failure)                              | ●                             | ●                             |
|                           | 3-D Airflow                                   | ●                             | ●                             |                                       | Self-Diagnosis (Digital, LED) Display                           | ●                             | ●                             |
| COMFORT AIRFLOW Operation | ●   | ●                             | Wiring Error Check Function   | —                                     | —   |                               |                               |
| Comfort Control           | Auto Fan Speed                                | ●                             | ●                             | Flexibility                           | Anticorrosion Treatment of Outdoor Heat Exchanger               | ●                             | ●                             |
|                           | Indoor Unit Quiet Operation                   | ●                             | ●                             |                                       | Multi-Split / Split Type Compatible Indoor Unit                 | —                             | —                             |
|                           | NIGHT QUIET Mode (Automatic)                  | —                             | —                             |                                       | H/P, C/O Compatible Indoor Unit                                 | ●                             | ●                             |
|                           | Outdoor Unit Quiet Operation (Manual)         | ●                             | ●                             |                                       | Flexible Power Supply Correspondence                            | —                             | —                             |
|                           | INTELLIGENT EYE Operation                     | ●                             | ●                             |                                       | Chargeless  | 32 ft                         | 32 ft                         |
|                           | Quick Warming Function (Preheating Operation) | —                             | ●                             |                                       | Either Side Drain (Right or Left)                               | ●                             | ●                             |
|                           | Hot-Start Function                            | —                             | ●                             |                                       | Power Selection   | —                             | —                             |
| Operation                 | Automatic Operation                           | —                             | ●                             | Remote Control                        | Low Temperature Cooling Operation (-15°C) (5°F)                 | ●                             | ●                             |
|                           | Program Dry Function                          | ●                             | ●                             |                                       | °F/°C Changeover R/C Temperature Display (factory setting : °F) | ●                             | ●                             |
|                           | Fan Only                                      | ●                             | ●                             |                                       | 5-Rooms Centralized Controller (Option)                         | ●                             | ●                             |
| Lifestyle Convenience     | New POWERFUL Operation (Non-Inverter)         | —                             | —                             | Remote Controller                     | Remote Control Adaptor (Normal Open-Pulse Contact) (Option)     | ●                             | ●                             |
|                           | Inverter POWERFUL Operation                   | ●                             | ●                             |                                       | Remote Control Adaptor (Normal Open Contact) (Option)           | ●                             | ●                             |
|                           | Priority-Room Setting                         | —                             | —                             |                                       | DIII-NET Compatible (Adaptor) (Option)                          | ●                             | ●                             |
|                           | COOL / HEAT Mode Lock                         | —                             | —                             |                                       | Wireless  | ●                             | ●                             |
|                           | HOME LEAVE Operation                          | —                             | —                             |                                       | Wired (Option)  | ●                             | ●                             |
|                           | ECONO Operation                               | ●                             | ●                             |                                       |   |                               |                               |
|                           | Indoor Unit ON/OFF Button                     | ●                             | ●                             |                                       |   |                               |                               |
|                           | Signal Receiving Sign                         | ●                             | ●                             |                                       |   |                               |                               |
|                           | R/C with Back Light                           | ●                             | ●                             |                                       |   |                               |                               |
|                           | Temperature Display                           | —                             | —                             |                                       |   |                               |                               |

**Note:** ● : Holding Functions  
 — : No Functions

## 3. Specifications

### 3.1 Cooling Only

60 Hz, 208 - 230 V

| Model                                      | Indoor Unit    |                          | FTXS30LVJU  |  | FTXS36LVJU  |  |
|--|----------------|--------------------------|---|--|---|--|
|  | Outdoor Unit   |                          | RKS30LVJU   |  | RKS36LVJU   |  |
| Capacity Rated (Min. ~ Max.)               | kW             |                          | 8.8 (3.0 ~ 8.8)                                   |  | 10.5 (3.0 ~ 10.5)                                 |  |
|  | Btu/h          |                          | 30,000 (10,200 ~ 30,000)                          |  | 36,000 (10,200 ~ 36,000)                          |  |
|  | kcal/h         |                          | 7,570 (2,580 ~ 7,570)                             |  | 9,030 (2,580 ~ 9,030)                             |  |
| Moisture Removal                           | gal/h (L/h)    |                          | 1.5 (5.8)   |  | 1.8 (6.9)   |  |
| Running Current (Rated)                    | A              |                          | 13.6 - 12.2                                       |  | 18.8  |  |
| Power Consumption Rated (Min. - Max.)      | W              |                          | 2,800 (620 ~ 2,800)                               |  | 4,300 (620 ~ 4,300)                               |  |
| Power Factor (Rated)                       | %              |                          | 99.8  |  | 99.4  |  |
| EER (Rated)                                | Btu/h-W        |                          | 10.71   |  | 8.37  |  |
| SEER                                       |                |                          | 19.3  |  | 17.9  |  |
| Piping Connections                         | Liquid         | in. (mm)                 | φ 3/8 (9.5)                                       |  | φ 3/8 (9.5)                                       |  |
|  | Gas            | in. (mm)                 | φ 5/8 (15.9)                                      |  | φ 5/8 (15.9)                                      |  |
|  | Drain          | in. (mm)                 | φ 5/8 (16.0)                                      |  | φ 5/8 (16.0)                                      |  |
| Heat Insulation                            |                |                          | Both Liquid and Gas Pipes                         |  | Both Liquid and Gas Pipes                         |  |
| Max. Interunit Piping Length               | ft (m)         |                          | 98.4 (30)   |  | 98.4 (30)   |  |
| Max. Interunit Height Difference           | ft (m)         |                          | 65.6 (20)   |  | 65.6 (20)   |  |
| Chargeless                                 | ft (m)         |                          | 32 (10)   |  | 32 (10)   |  |
| Amount of Additional Charge of Refrigerant | oz/ft (g/m)    |                          | 0.54 (50)   |  | 0.54 (50)   |  |
| <b>Indoor Unit</b>                         |                |                          | <b>FTXS30LVJU</b>                                 |  | <b>FTXS36LVJU</b>                                 |  |
| Front Panel Color                          |                |                          | White   |  | White   |  |
| Airflow Rate                               | H              | cfm(m <sup>3</sup> /min) | 706 (20.0)  |  | 770 (21.8)  |  |
|  | M              |                          | 611 (17.3)  |  | 635 (18.0)  |  |
|  | L              |                          | 519 (14.7)  |  | 519 (14.7)  |  |
|  | SL             |                          | 473 (13.4)  |  | 473 (13.4)  |  |
| Fan  | Type           |                          | Cross Flow Fan                                    |  | Cross Flow Fan                                    |  |
|  | Motor Output   | W                        | 64  |  | 64  |  |
|  | Speed          | Steps                    | 5 Steps, Quiet, Auto                              |  | 5 Steps, Quiet, Auto                              |  |
| Air Direction Control                      |                |                          | Right, Left, Horizontal, Downward                 |  | Right, Left, Horizontal, Downward                 |  |
| Air Filter                                 |                |                          | Removable / Washable / Mildew Proof               |  | Removable / Washable / Mildew Proof               |  |
| Running Current (Rated)                    | A              |                          | 0.38 - 0.34                                       |  | 0.38 - 0.34                                       |  |
| Power Consumption (Rated)                  | W              |                          | 77  |  | 77  |  |
| Power Factor (Rated)                       | %              |                          | 97.4 - 98.5                                       |  | 97.4 - 98.5                                       |  |
| Temperature Control                        |                |                          | Microcomputer Control                             |  | Microcomputer Control                             |  |
| Dimensions (H x W x D)                     | in. (mm)       |                          | 13-3/8 x 47-1/4 x 9-7/16 (340 x 1,200 x 240)      |  | 13-3/8 x 47-1/4 x 9-7/16 (340 x 1,200 x 240)      |  |
| Packaged Dimensions (H x W x D)            | in. (mm)       |                          | 12-13/16 x 51-9/16 x 16-7/8 (325 x 1,310 x 429)   |  | 12-13/16 x 51-9/16 x 16-7/8 (325 x 1,310 x 429)   |  |
| Weight (Mass)                              | Lbs (kg)       |                          | 38 (17)   |  | 38 (17)   |  |
| Gross Weight (Gross Mass)                  | Lbs (kg)       |                          | 51 (23)   |  | 51 (23)   |  |
| Sound Pressure Level                       | H / M / L / SL | dB(A)                    | 47 / 45 / 40 / 37                                 |  | 49 / 45 / 40 / 37                                 |  |
| Sound Power Level                          | dB             |                          | 63  |  | 65  |  |
| <b>Outdoor Unit</b>                        |                |                          | <b>RKS30LVJU</b>                                  |  | <b>RKS36LVJU</b>                                  |  |
| Casing Color                               |                |                          | Ivory White                                       |  | Ivory White                                       |  |
| Compressor                                 | Type           |                          | Hermetically Sealed Swing Type                    |  | Hermetically Sealed Swing Type                    |  |
|  | Model          |                          | 2YC63FXD  |  | 2YC63FXD  |  |
|  | Motor Output   | W                        | 2,030   |  | 2,030   |  |
| Refrigerant Oil                            | Type           |                          | FVC50K  |  | FVC50K  |  |
|  | Charge         | oz (L)                   | 25.5 (0.75)                                       |  | 25.5 (0.75)                                       |  |
| Refrigerant                                | Type           |                          | R-410A  |  | R-410A  |  |
|  | Charge         | Lbs (kg)                 | 6.17 (2.8)  |  | 6.17 (2.8)  |  |
| Airflow Rate                               | H              | cfm(m <sup>3</sup> /min) | 2,627 (74.4)                                      |  | 2,627 (74.4)                                      |  |
|  | SL             |                          | 2,316 (65.6)                                      |  | 2,316 (65.6)                                      |  |
| Fan  | Type           |                          | Propeller   |  | Propeller   |  |
|  | Motor Output   | W                        | 200   |  | 200   |  |
| Running Current (Rated)                    | A              |                          | 11.86   |  | 18.46   |  |
| Power Consumption (Rated)                  | W              |                          | 2,723   |  | 4,223   |  |
| Power Factor (Rated)                       | %              |                          | 99.8  |  | 99.5  |  |
| Starting Current                           | A              |                          | 18.9  |  | 19.4  |  |
| Dimensions (H x W x D)                     | in. (mm)       |                          | 38-15/16 x 37 x 12-5/8 (990 x 940 x 320)          |  | 38-15/16 x 37 x 12-5/8 (990 x 940 x 320)          |  |
| Packaged Dimensions (H x W x D)            | in. (mm)       |                          | 43-7/8 x 39-7/16 x 16-11/16 (1,114 x 1,003 x 425) |  | 43-7/8 x 39-7/16 x 16-11/16 (1,114 x 1,003 x 425) |  |
| Weight (Mass)                              | Lbs (kg)       |                          | 179 (81)  |  | 179 (81)  |  |
| Gross Weight (Gross Mass)                  | Lbs (kg)       |                          | 204 (93)  |  | 204 (93)  |  |
| Sound Pressure Level                       | H / SL         | dB(A)                    | 54 / 51   |  | 54 / 51   |  |
| Sound Power Level                          | H              | dB                       | 68  |  | 68  |  |
| Drawing No.                                |                |                          | 3D075052  |  | 3D075064  |  |

**Note:**

■ The data are based on the conditions shown in the table below.

| Cooling   | Piping Length |
|---|---------------|
| Indoor ; 80°FDB (26.7°CDB) / 67°F WB (19.4°CWB)<br>Outdoor ; 95°FDB (35°CDB) / 75°F WB (24°CWB) | 25 ft (7.5 m) |

| Conversion Formulae              |
|----------------------------------|
| kcal/h = kW × 860                |
| Btu/h = kW × 3412                |
| cfm = m <sup>3</sup> /min × 35.3 |

### 3.2 Heat Pump

60 Hz, 208 - 230 V

| Model                                      | Indoor Unit    |             | FTXS30LVJU  |                          | FTXS36LVJU  |                                     |
|--|----------------|-------------|---|--------------------------|---|-------------------------------------|
|  | Outdoor Unit   |             | RXS30LVJU   |                          | RXS36LVJU   |                                     |
|  |                |             | Cooling   | Heating                  | Cooling   | Heating                             |
| Capacity Rated (Min. ~ Max.)               | kW             |             | 8.8 (3.0 ~ 8.8)                                   | 10.2 (3.0 ~ 10.2)        | 10.5 (3.0 - 10.5)                                 | 11.1 (3.0 - 11.1)                   |
|  | Btu/h          |             | 30,000 (10,200 ~ 30,000)                          | 34,800 (10,200 ~ 34,800) | 36,000 (10,200 - 36,000)                          | 38,000 (10,200- 38,000)             |
|  | kcal/h         |             | 7,570 (2,580 ~ 7,570)                             | 8,770 (2,580 ~ 8,770)    | 9,030 (2,580 - 9,030)                             | 9,550 (2,580 - 9,550)               |
| Moisture Removal                           | gal/h (L/h)    |             | 1.5 (5.8)   | —                        | 1.8 (6.9)   | —                                   |
| Running Current (Rated)                    | A              |             | 12.2  | 17.1                     | 18.8  | 18.4                                |
| Power Consumption Rated (Min. - Max.)      | W              |             | 2,800 (620 ~ 2,800)                               | 3,900 (620 ~ 3,900)      | 4,000 - 4,300 (620 ~ 4,000 - 4,300)               | 3,800 - 4,200 (620 ~ 3,800 - 4,200) |
| Power Factor (Rated)                       | %              |             | 99.8  | 99.2                     | 99.4  | 99.2                                |
| EER (Rated)                                | Btu/h-W        |             | 10.71 (16.45 ~ 10.71)                             | 8.92 (16.45 ~ 8.92)      | 8.75 - 8.37 (16.45 ~ 8.75 - 8.37)                 | 9.47 - 9.05 (16.45 ~ 9.47 - 9.05)   |
| SEER/HSPF                                  |                |             | 19.3  | 8.3                      | 17.9  | 8.3                                 |
| Piping Connections                         | Liquid         | in. (mm)    | φ 3/8 (9.5)                                       |                          | φ 3/8 (9.5)                                       |                                     |
|  | Gas            | in. (mm)    | φ 5/8 (15.9)                                      |                          | φ 5/8 (15.9)                                      |                                     |
|  | Drain          | in. (mm)    | φ 5/8 (16.0)                                      |                          | φ 5/8 (16.0)                                      |                                     |
| Heat Insulation                            |                |             | Both Liquid and Gas Pipes                         |                          | Both Liquid and Gas Pipes                         |                                     |
| Max. Interunit Piping Length               |                | ft (m)      | 98.4 (30)   |                          | 98.4 (30)   |                                     |
| Max. Interunit Height Difference           |                | ft (m)      | 65.6 (20)   |                          | 65.6 (20)   |                                     |
| Chargeless                                 |                | ft (m)      | 32 (10)   |                          | 32 (10)   |                                     |
| Amount of Additional Charge of Refrigerant |                | oz/ft (g/m) | 0.54 (50)   |                          | 0.54 (50)   |                                     |
| <b>Indoor Unit</b>                         |                |             | <b>FTXS30LVJU</b>                                 |                          | <b>FTXS36LVJU</b>                                 |                                     |
| Front Panel Color                          |                |             | White   |                          | White   |                                     |
| Airflow Rate                               | H              | cfm(m³/min) | 706 (20.0)  | 710 (20.1)               | 770 (21.8)  | 808 (22.9)                          |
|  | M              |             | 611 (17.3)  | 611 (17.3)               | 635 (18.0)  | 657 (18.6)                          |
|  | L              |             | 519 (14.7)  | 519 (14.7)               | 519 (14.7)  | 519 (14.7)                          |
|  | SL             |             | 473 (13.4)  | 469 (13.3)               | 473 (13.4)  | 469 (13.3)                          |
| Fan  | Type           |             | Cross Flow Fan                                    |                          | Cross Flow Fan                                    |                                     |
|  | Motor Output   |             | 64  |                          | 64  |                                     |
|  | Speed          |             | 5 Steps, Quiet, Auto                              |                          | 5 Steps, Quiet, Auto                              |                                     |
| Air Direction Control                      |                |             | Right, Left, Horizontal, Downward                 |                          | Right, Left, Horizontal, Downward                 |                                     |
| Air Filter                                 |                |             | Removable / Washable / Mildew Proof               |                          | Removable / Washable / Mildew Proof               |                                     |
| Running Current (Rated)                    | A              |             | 0.38 - 0.34                                       | 0.38 - 0.34              | 0.38 - 0.34                                       | 0.38 - 0.34                         |
| Power Consumption (Rated)                  | W              |             | 77  | 77                       | 77  | 77                                  |
| Power Factor (Rated)                       | %              |             | 97.4 - 98.5                                       | 97.4 - 98.5              | 97.4 - 98.5                                       | 97.4 - 98.5                         |
| Temperature Control                        |                |             | Microcomputer Control                             |                          | Microcomputer Control                             |                                     |
| Dimensions (H x W x D)                     |                | in. (mm)    | 13-3/8 x 47-1/4 x 9-7/16 (340 x 1,200 x 240)      |                          | 13-3/8 x 47-1/4 x 9-7/16 (340 x 1,200 x 240)      |                                     |
| Packaged Dimensions (H x W x D)            |                | in. (mm)    | 12-13/16 x 51-9/16 x 16-7/8 (325 x 1,310 x 429)   |                          | 12-13/16 x 51-9/16 x 16-7/8 (325 x 1,310 x 429)   |                                     |
| Weight (Mass)                              |                | Lbs (kg)    | 38 (17)   |                          | 38 (17)   |                                     |
| Gross Weight (Gross Mass)                  |                | Lbs (kg)    | 51 (23)   |                          | 51 (23)   |                                     |
| Sound Pressure Level                       | H / M / L / SL | dB(A)       | 47 / 45 / 40 / 37                                 | 47 / 44 / 38 / 35        | 49 / 45 / 40 / 37                                 | 49 / 44 / 38 / 35                   |
| Sound Power Level                          |                | dB          | 63  | 63                       | 65  | 65                                  |
| <b>Outdoor Unit</b>                        |                |             | <b>RXS30LVJU</b>                                  |                          | <b>RXS36LVJU</b>                                  |                                     |
| Casing Color                               |                |             | Ivory White                                       |                          | Ivory White                                       |                                     |
| Compressor                                 | Type           |             | Hermetically Sealed Swing Type                    |                          | Hermetically Sealed Swing Type                    |                                     |
|  | Model          |             | 2YC63FXD  |                          | 2YC63FXD  |                                     |
| Refrigerant Oil                            | Motor Output   |             | 2,030   |                          | 2,030   |                                     |
|  | Type           |             | FVC50K  |                          | FVC50K  |                                     |
| Refrigerant                                | Charge         |             | 25.5 (0.75)                                       |                          | 25.5 (0.75)                                       |                                     |
|  | Type           |             | R-410A  |                          | R-410A  |                                     |
| Airflow Rate                               | Charge         |             | 6.17 (2.8)  |                          | 6.17 (2.8)  |                                     |
|  | H              | cfm(m³/min) | 2,627 (74.4)                                      | 2,627 (74.4)             | 2,627 (74.4)                                      | 2,627 (74.4)                        |
| SL   | 2,316 (65.6)   |             | 2,316 (65.6)                                      | 2,316 (65.6)             | 2,316 (65.6)                                      |                                     |
| Fan  | Type           |             | Propeller   |                          | Propeller   |                                     |
|  | Motor Output   |             | 200   |                          | 200   |                                     |
| Running Current (Rated)                    | A              |             | 111.86  | 16.76                    | 18.46   | 18.06                               |
| Power Consumption (Rated)                  | W              |             | 2,723   | 3,823                    | 4,223   | 4,123                               |
| Power Factor (Rated)                       | %              |             | 99.8  | 99.2                     | 99.5  | 99.3                                |
| Starting Current                           | A              |             | 18.9  | 19.4                     | 19.4  | 19.4                                |
| Dimensions (H x W x D)                     |                | in. (mm)    | 38-15/16 x 37 x 12-5/8 (990 x 940 x 320)          |                          | 38-15/16 x 37 x 12-5/8 (990 x 940 x 320)          |                                     |
| Packaged Dimensions (H x W x D)            |                | in. (mm)    | 43-7/8 x 39-7/16 x 16-11/16 (1,114 x 1,003 x 425) |                          | 43-7/8 x 39-7/16 x 16-11/16 (1,114 x 1,003 x 425) |                                     |
| Weight (Mass)                              |                | Lbs (kg)    | 179 (81)  |                          | 179 (81)  |                                     |
| Gross Weight (Gross Mass)                  |                | Lbs (kg)    | 204 (93)  |                          | 204 (93)  |                                     |
| Sound Pressure Level                       | H / SL         | dB(A)       | 54 / 51   | 55 / 51                  | 54 / 51   | 55 / 51                             |
| Sound Power Level                          |                | dB          | 68  | 69                       | 68  | 69                                  |
| Drawing No.                                |                |             | 3D075050  |                          | 3D075055  |                                     |

|                     |
|---------------------|
| Conversion Formulae |
| kcal/h = kW x 860   |
| Btu/h = kW x 3412   |
| cfm = m³/min x 35.3 |



**Note:**

■ The data are based on the conditions shown in the table below.

| Cooling   | Heating   | Piping Length |
|---|---|---------------|
| Indoor ; 80°FDB (26.7°CDB) / 67°FWB<br>(19.4°CWB)<br>Outdoor ; 95°FDB (35°CDB) / 75°FWB<br>(24°CWB) | Indoor ; 70°FDB (21.1°CDB) / 60°FWB<br>(15.6°CWB)<br>Outdoor ; 47°FDB (8.3°CDB) / 43°FWB<br>(6°CWB) | 25 ft (7.5 m) |



# 5. Wiring Diagrams

## FTXS30/36LVJU

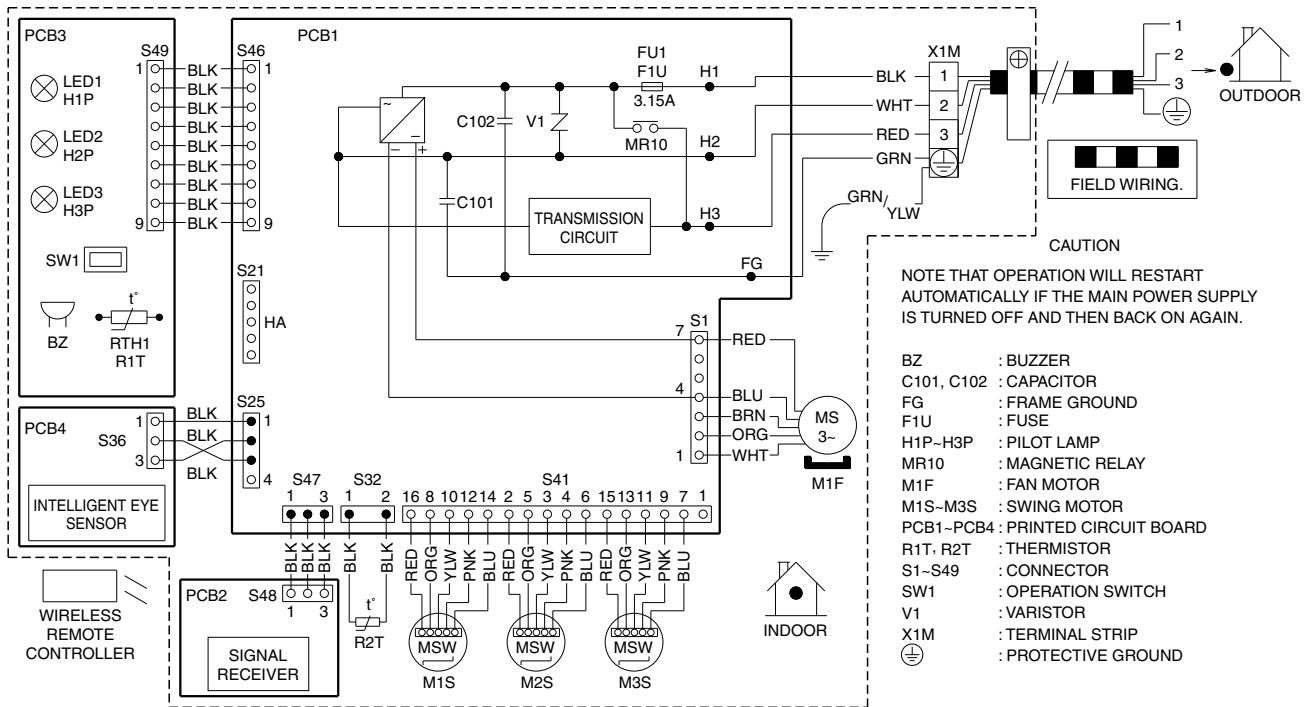

C: 3D060942H

## RKS30/36LVJU, RXS30/36LVJU

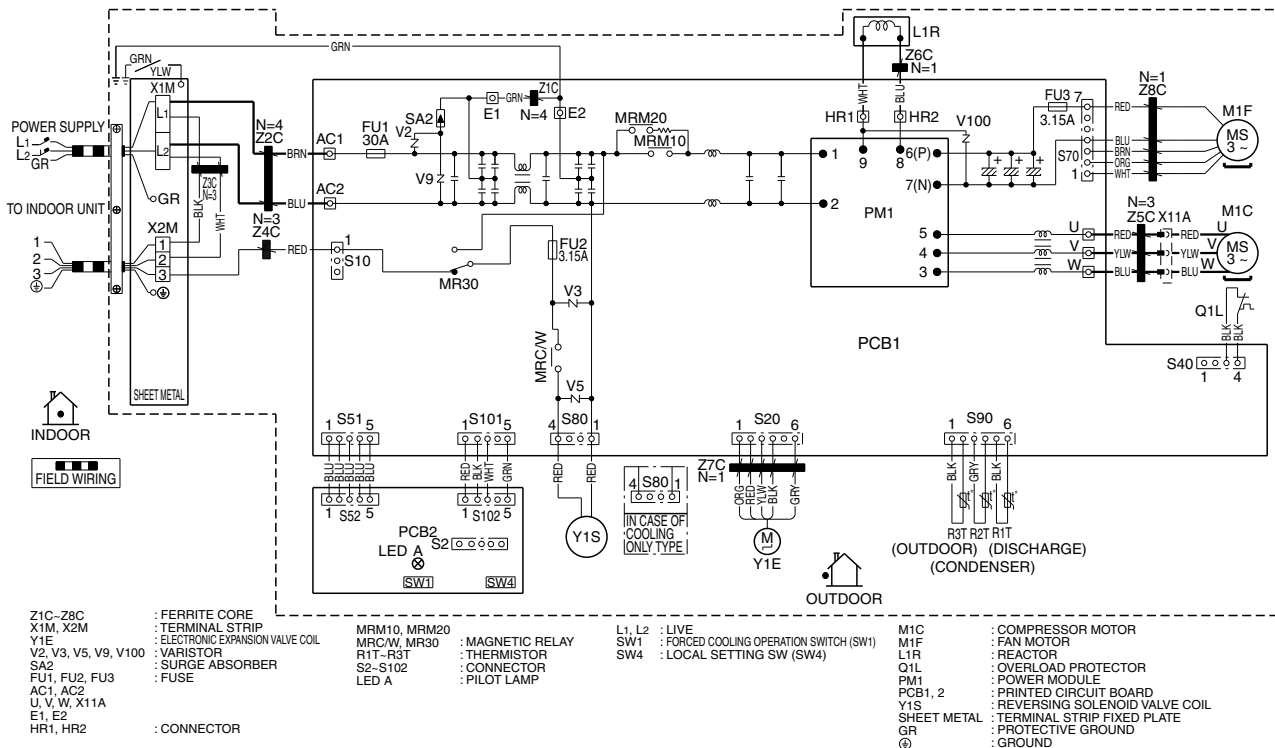

3D074291A

# 6. Piping Diagrams

## 6.1 Indoor Unit

FTXS30/36LVJU

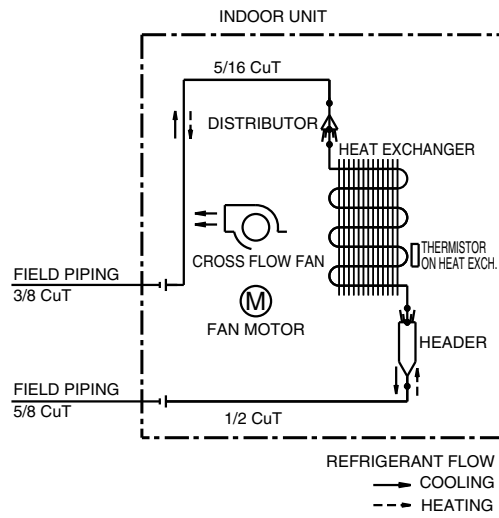

4D062742A

## 6.2 Outdoor Unit

### RKS30/36LVJU

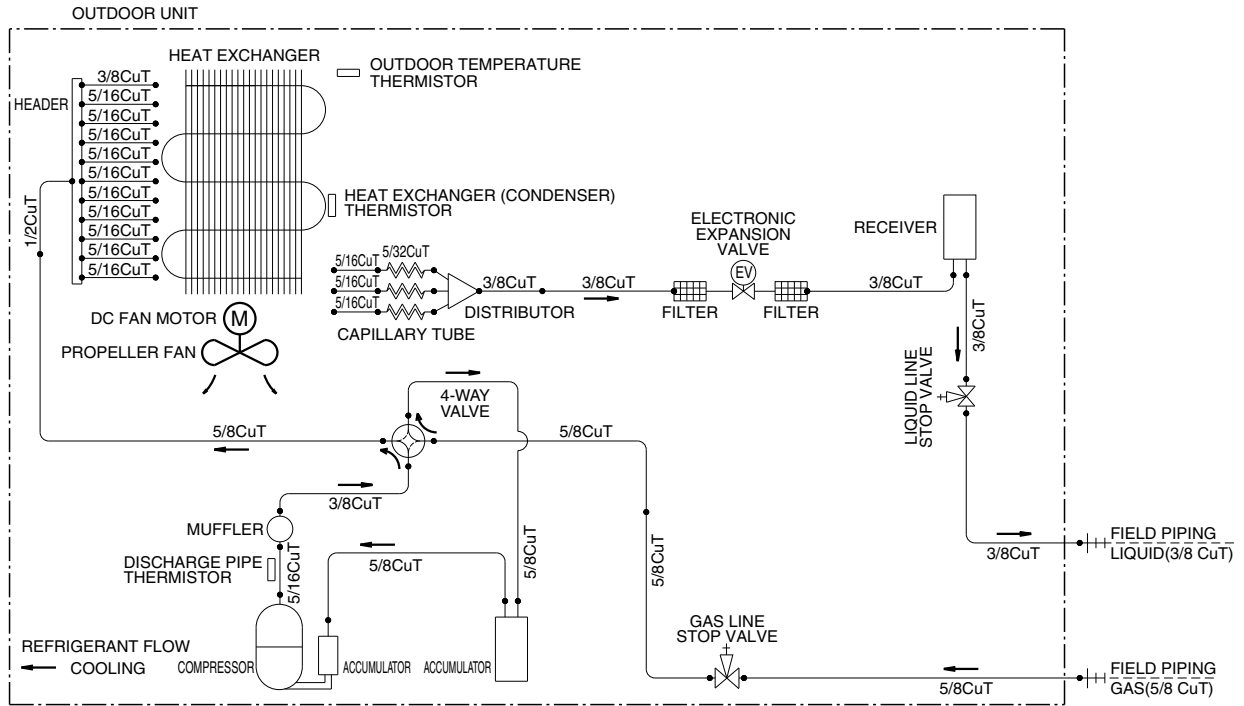

3D074193

### RXS30/36LVJU

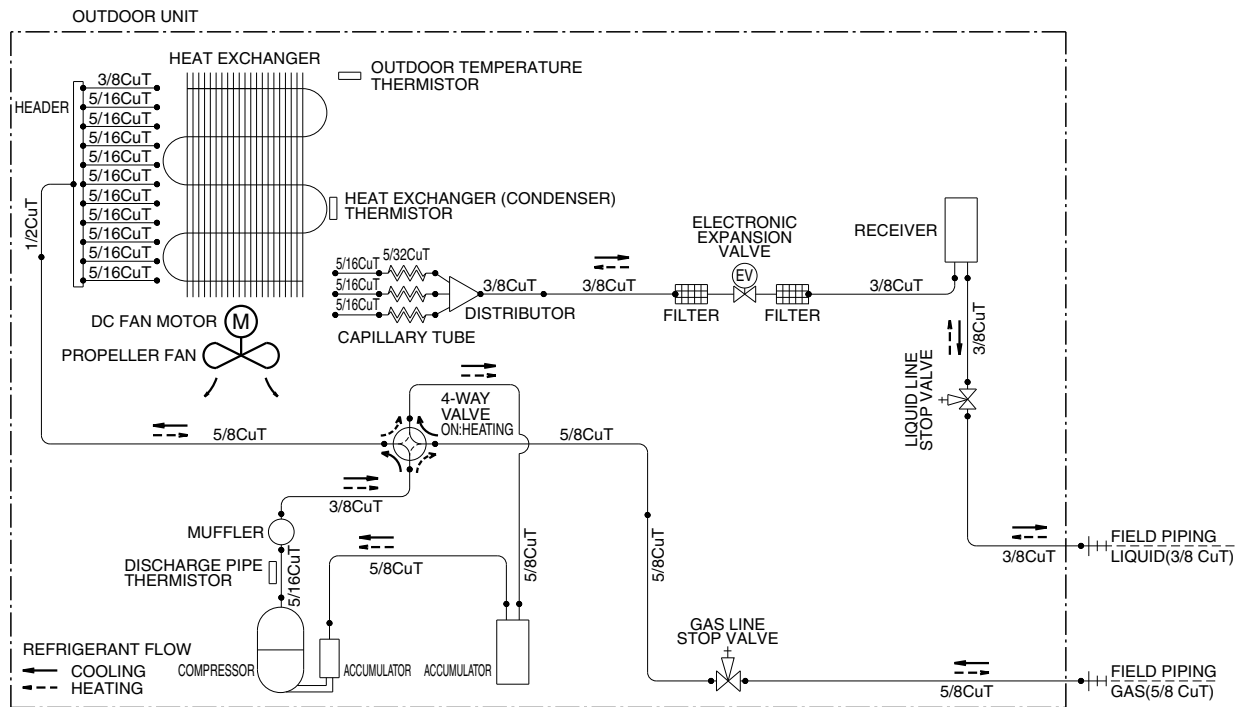

3D074192

# 7. Capacity Tables

## 7.1 Cooling Only

### FTXS30LVJU + RKS30LVJU (60 Hz, 208 - 230 V)

|     |      |
|-----|------|
| AFR | 20.0 |
| BF  | 0.23 |

Temp: Celsius  
TC, SHC, PI: kW

| INDOOR |      | OUTDOOR TEMPERATURE (°CDB) |      |      |       |      |      |       |      |      |       |      |      |      |      |      |      |      |      |
|--------|------|----------------------------|------|------|-------|------|------|-------|------|------|-------|------|------|------|------|------|------|------|------|
| EWB    | EDB  | 20                         |      |      | 25    |      |      | 30    |      |      | 32    |      |      | 35   |      |      | 40   |      |      |
|        |      | °C                         | °C   | TC   | SHC   | PI   | TC   | SHC   | PI   | TC   | SHC   | PI   | TC   | SHC  | PI   | TC   | SHC  | PI   |      |
| 14.0   | 20.0 | 6.92                       | 4.97 | 1.38 | 6.92  | 4.97 | 1.61 | 6.92  | 4.97 | 1.88 | 6.92  | 4.97 | 2.00 | 6.92 | 4.97 | 2.20 | 6.92 | 4.97 | 2.46 |
| 16.0   | 22.0 | 8.63                       | 5.59 | 1.85 | 8.63  | 5.59 | 2.18 | 8.60  | 5.58 | 2.57 | 8.44  | 5.49 | 2.66 | 8.19 | 5.37 | 2.78 | 7.78 | 5.16 | 2.81 |
| 18.0   | 25.0 | 9.83                       | 6.19 | 2.17 | 9.42  | 5.99 | 2.38 | 9.01  | 5.78 | 2.59 | 8.84  | 5.70 | 2.67 | 8.60 | 5.59 | 2.79 | 8.19 | 5.39 | 2.82 |
| 19.4   | 26.7 | 10.03                      | 6.43 | 2.18 | 9.62  | 6.23 | 2.39 | 9.21  | 6.04 | 2.59 | 9.05  | 5.96 | 2.68 | 8.80 | 5.84 | 2.80 | 8.39 | 5.66 | 2.83 |
| 22.0   | 30.0 | 10.64                      | 6.17 | 2.20 | 10.23 | 5.99 | 2.40 | 9.82  | 5.82 | 2.61 | 9.65  | 5.75 | 2.69 | 9.41 | 5.65 | 2.82 | 9.00 | 5.48 | 2.84 |
| 24.0   | 32.0 | 11.04                      | 5.97 | 2.21 | 10.63 | 5.81 | 2.42 | 10.22 | 5.65 | 2.62 | 10.06 | 5.59 | 2.71 | 9.81 | 5.49 | 2.83 | 9.40 | 5.34 | 2.86 |

Temp: Fahrenheit  
TC, SHC: kBtu/h  
PI: kW

| INDOOR |      | OUTDOOR TEMPERATURE (°FDB) |       |      |       |       |      |       |       |      |       |       |      |       |       |      |       |       |      |
|--------|------|----------------------------|-------|------|-------|-------|------|-------|-------|------|-------|-------|------|-------|-------|------|-------|-------|------|
| EWB    | EDB  | 68                         |       |      | 77    |       |      | 86    |       |      | 90    |       |      | 95    |       |      | 104   |       |      |
|        |      | °F                         | °F    | TC   | SHC   | PI    | TC   | SHC   | PI    | TC   | SHC   | PI    | TC   | SHC   | PI    | TC   | SHC   | PI    |      |
| 57.2   | 68.0 | 23.61                      | 16.97 | 1.38 | 23.61 | 16.97 | 1.61 | 23.61 | 16.97 | 1.88 | 23.61 | 16.97 | 2.00 | 23.61 | 16.97 | 2.20 | 23.61 | 16.97 | 2.46 |
| 60.8   | 71.6 | 29.44                      | 19.09 | 1.85 | 29.44 | 19.09 | 2.18 | 29.35 | 19.04 | 2.57 | 28.79 | 18.75 | 2.66 | 27.95 | 18.31 | 2.78 | 26.55 | 17.61 | 2.81 |
| 64.4   | 77.0 | 33.53                      | 21.13 | 2.17 | 32.13 | 20.43 | 2.38 | 30.73 | 19.74 | 2.59 | 30.17 | 19.47 | 2.67 | 29.33 | 19.06 | 2.79 | 27.94 | 18.40 | 2.82 |
| 67.0   | 80.0 | 34.22                      | 21.94 | 2.18 | 32.82 | 21.26 | 2.39 | 31.42 | 20.59 | 2.59 | 30.86 | 20.33 | 2.68 | 30.00 | 19.94 | 2.80 | 28.63 | 19.30 | 2.83 |
| 71.6   | 86.0 | 36.29                      | 21.04 | 2.20 | 34.90 | 20.43 | 2.40 | 33.50 | 19.84 | 2.61 | 32.94 | 19.61 | 2.69 | 32.10 | 19.26 | 2.82 | 30.70 | 18.69 | 2.84 |
| 75.2   | 89.6 | 37.68                      | 20.37 | 2.21 | 36.28 | 19.82 | 2.42 | 34.88 | 19.28 | 2.62 | 34.32 | 19.06 | 2.71 | 33.48 | 18.74 | 2.83 | 32.09 | 18.22 | 2.86 |

**Symbols:**

- AFR : Airflow rate (m³/min.)
- BF : Bypass factor
- EWB : Entering wet bulb temp. (°C) / (°F)
- EDB : Entering dry bulb temp. (°C) / (°F)
- TC : Total capacity (kW) / (kBtu/h)
- SHC : Sensible heat capacity (kW) / (kBtu/h)
- PI : Power input (kW)

**Note:**

1. Ratings shown are net capacities which include a deduction for indoor fan motor heat.
2. ■ shows nominal (rated) capacities and power input.
3. TC, PI and SHC must be calculated by interpolation using the figures in the tables. (Figures out of the tables should not be used for calculation.)
4. SHC values not included in the table must be calculated using interpolation with values of direct proportion.
5. Capacities are based on the following conditions.  
Corresponding refrigerant piping length : 25 ft  
Level difference : 0 ft
6. Cooling capacity at -15°CDB and 5°FDB.

Temp: Celsius  
TC, SHC, PI: kW  
60 Hz, 208 - 230 V

| INDOOR |      | OUTDOOR    |      |      |
|--------|------|------------|------|------|
| EWB    | EDB  | -15 (°CDB) |      |      |
|        |      | °C         | °C   | PI   |
| 14.0   | 20.0 | 5.49       | 4.28 | 0.49 |

Temp: Fahrenheit  
TC, SHC: kBtu/h  
PI: kW  
60 Hz, 208 - 230 V

| INDOOR |      | OUTDOOR  |       |      |
|--------|------|----------|-------|------|
| EWB    | EDB  | 5 (°FDB) |       |      |
|        |      | °F       | °F    | PI   |
| 57.2   | 68.0 | 18.73    | 14.59 | 0.49 |

## FTXS36LVJU + RKS36LVJU (60 Hz, 208 - 230 V)

|     |      |
|-----|------|
| AFR | 21.8 |
| BF  | 0.27 |

Temp: Celsius  
TC, SHC, PI: kW

| INDOOR |      |       | OUTDOOR TEMPERATURE (°CDB) |      |       |      |      |       |      |      |       |      |      |       |      |      |       |      |      |  |
|--------|------|-------|----------------------------|------|-------|------|------|-------|------|------|-------|------|------|-------|------|------|-------|------|------|--|
| EWB    | EDB  | 20    |                            |      | 25    |      |      | 30    |      |      | 32    |      |      | 35    |      |      | 40    |      |      |  |
|        |      | °C    | °C                         | TC   | SHC   | PI   | TC   | SHC   | PI   | TC   | SHC   | PI   | TC   | SHC   | PI   | TC   | SHC   | PI   |      |  |
| 14.0   | 20.0 | 7.15  | 5.14                       | 1.54 | 7.15  | 5.14 | 1.77 | 7.15  | 5.14 | 2.05 | 7.15  | 5.14 | 2.17 | 7.15  | 5.14 | 2.38 | 7.15  | 5.14 | 2.67 |  |
| 16.0   | 22.0 | 8.92  | 5.78                       | 2.09 | 8.92  | 5.78 | 2.44 | 8.92  | 5.78 | 2.87 | 8.92  | 5.78 | 3.07 | 8.92  | 5.78 | 3.41 | 8.92  | 5.78 | 3.89 |  |
| 18.0   | 25.0 | 10.82 | 6.74                       | 2.80 | 10.82 | 6.74 | 3.35 | 10.75 | 6.70 | 3.97 | 10.55 | 6.60 | 4.10 | 10.26 | 6.45 | 4.29 | 9.60  | 6.12 | 4.24 |  |
| 19.4   | 26.7 | 11.82 | 7.38                       | 3.25 | 11.48 | 7.20 | 3.66 | 10.99 | 6.95 | 3.98 | 10.79 | 6.86 | 4.11 | 10.50 | 6.71 | 4.30 | 9.82  | 6.38 | 4.24 |  |
| 22.0   | 30.0 | 12.69 | 7.14                       | 3.37 | 12.20 | 6.91 | 3.69 | 11.71 | 6.69 | 4.01 | 11.52 | 6.60 | 4.14 | 11.23 | 6.47 | 4.33 | 10.50 | 6.16 | 4.24 |  |
| 24.0   | 32.0 | 13.18 | 6.90                       | 3.39 | 12.69 | 6.69 | 3.71 | 12.20 | 6.49 | 4.03 | 12.00 | 6.41 | 4.16 | 11.71 | 6.29 | 4.35 | 10.95 | 5.99 | 4.24 |  |

Temp: Fahrenheit  
TC, SHC: kBtu/h  
PI: kW

| INDOOR |      |       | OUTDOOR TEMPERATURE (°FDB) |      |       |       |      |       |       |      |       |       |      |       |       |      |       |       |      |  |
|--------|------|-------|----------------------------|------|-------|-------|------|-------|-------|------|-------|-------|------|-------|-------|------|-------|-------|------|--|
| EWB    | EDB  | 68    |                            |      | 77    |       |      | 86    |       |      | 90    |       |      | 95    |       |      | 104   |       |      |  |
|        |      | °F    | °F                         | TC   | SHC   | PI    | TC   | SHC   | PI    | TC   | SHC   | PI    | TC   | SHC   | PI    | TC   | SHC   | PI    |      |  |
| 57.2   | 68.0 | 24.39 | 17.54                      | 1.54 | 24.39 | 17.54 | 1.77 | 24.39 | 17.54 | 2.05 | 24.39 | 17.54 | 2.17 | 24.39 | 17.54 | 2.38 | 24.39 | 17.54 | 2.67 |  |
| 60.8   | 71.6 | 30.43 | 19.72                      | 2.09 | 30.43 | 19.72 | 2.44 | 30.43 | 19.72 | 2.87 | 30.43 | 19.72 | 3.07 | 30.43 | 19.72 | 3.41 | 30.43 | 19.72 | 3.89 |  |
| 64.4   | 77.0 | 36.91 | 23.00                      | 2.80 | 36.91 | 23.00 | 3.35 | 36.67 | 22.87 | 3.97 | 36.00 | 22.52 | 4.10 | 35.00 | 22.01 | 4.29 | 32.75 | 20.89 | 4.24 |  |
| 67.0   | 80.0 | 40.33 | 25.18                      | 3.25 | 39.16 | 24.57 | 3.66 | 37.49 | 23.72 | 3.98 | 36.83 | 23.39 | 4.11 | 36.00 | 22.89 | 4.30 | 33.52 | 21.78 | 4.24 |  |
| 71.6   | 86.0 | 43.31 | 24.36                      | 3.37 | 41.64 | 23.58 | 3.69 | 39.97 | 22.83 | 4.01 | 39.30 | 22.53 | 4.14 | 38.30 | 22.09 | 4.33 | 35.82 | 21.01 | 4.24 |  |
| 75.2   | 89.6 | 44.96 | 23.54                      | 3.39 | 43.29 | 22.83 | 3.71 | 41.62 | 22.14 | 4.03 | 40.95 | 21.86 | 4.16 | 39.95 | 21.46 | 4.35 | 37.35 | 20.43 | 4.24 |  |

## Symbols:

|     |                           |                        |
|-----|---------------------------|------------------------|
| AFR | : Airflow rate            | (m <sup>3</sup> /min.) |
| BF  | : Bypass factor           |                        |
| EWB | : Entering wet bulb temp. | (°C) / (°F)            |
| EDB | : Entering dry bulb temp. | (°C) / (°F)            |
| TC  | : Total capacity          | (kW) / (kBtu/h)        |
| SHC | : Sensible heat capacity  | (kW) / (kBtu/h)        |
| PI  | : Power input             | (kW)                   |

## Note:

- Ratings shown are net capacities which include a deduction for indoor fan motor heat.
- shows nominal (rated) capacities and power input.
- TC, PI and SHC must be calculated by interpolation using the figures in the tables. (Figures out of the tables should not be used for calculation.)
- SHC values not included in the table must be calculated using interpolation with values of direct proportion.
- Capacities are based on the following conditions.  
Corresponding refrigerant piping length : 25 ft  
Level difference : 0 ft
- Cooling capacity at -15°CDB and 5°FDB.

Temp: Celsius  
TC, SHC, PI: kW  
60 Hz, 208 - 230 V

| INDOOR |      | OUTDOOR    |      |      |
|--------|------|------------|------|------|
| EWB    | EDB  | -15 (°CDB) |      |      |
| °C     | °C   | TC         | SHC  | PI   |
| 14.0   | 20.0 | 5.67       | 4.42 | 0.54 |

Temp: Fahrenheit  
TC, SHC: kBtu/h  
PI: kW  
60 Hz, 208 - 230 V

| INDOOR |      | OUTDOOR  |       |      |
|--------|------|----------|-------|------|
| EWB    | EDB  | 5 (°FDB) |       |      |
| °F     | °F   | TC       | SHC   | PI   |
| 57.2   | 68.0 | 19.35    | 15.08 | 0.54 |

## 7.2 Heat Pump

### FTXS30LVJU + RXS30LVJU (60 Hz, 208 - 230 V)

#### Cooling

|     |      |
|-----|------|
| AFR | 20.0 |
| BF  | 0.23 |

Temp: Celsius  
TC, SHC, PI: kW

| INDOOR |      | OUTDOOR TEMPERATURE (°CDB) |      |      |       |      |      |       |      |      |       |      |      |      |      |      |      |      |      |
|--------|------|----------------------------|------|------|-------|------|------|-------|------|------|-------|------|------|------|------|------|------|------|------|
| EWB    | EDB  | 20                         |      |      | 25    |      |      | 30    |      |      | 32    |      |      | 35   |      |      | 40   |      |      |
| °C     | °C   | TC                         | SHC  | PI   | TC    | SHC  | PI   | TC    | SHC  | PI   | TC    | SHC  | PI   | TC   | SHC  | PI   | TC   | SHC  | PI   |
| 14.0   | 20.0 | 6.92                       | 4.97 | 1.38 | 6.92  | 4.97 | 1.61 | 6.92  | 4.97 | 1.88 | 6.92  | 4.97 | 2.00 | 6.92 | 4.97 | 2.20 | 6.92 | 4.97 | 2.46 |
| 16.0   | 22.0 | 8.63                       | 5.59 | 1.85 | 8.63  | 5.59 | 2.18 | 8.60  | 5.58 | 2.57 | 8.44  | 5.49 | 2.66 | 8.19 | 5.37 | 2.78 | 7.78 | 5.16 | 2.81 |
| 18.0   | 25.0 | 9.83                       | 6.19 | 2.17 | 9.42  | 5.99 | 2.38 | 9.01  | 5.78 | 2.59 | 8.84  | 5.70 | 2.67 | 8.60 | 5.59 | 2.79 | 8.19 | 5.39 | 2.82 |
| 19.4   | 26.7 | 10.03                      | 6.43 | 2.18 | 9.62  | 6.23 | 2.39 | 9.21  | 6.04 | 2.59 | 9.05  | 5.96 | 2.68 | 8.80 | 5.84 | 2.80 | 8.39 | 5.66 | 2.83 |
| 22.0   | 30.0 | 10.64                      | 6.17 | 2.20 | 10.23 | 5.99 | 2.40 | 9.82  | 5.82 | 2.61 | 9.65  | 5.75 | 2.69 | 9.41 | 5.65 | 2.82 | 9.00 | 5.48 | 2.84 |
| 24.0   | 32.0 | 11.04                      | 5.97 | 2.21 | 10.63 | 5.81 | 2.42 | 10.22 | 5.65 | 2.62 | 10.06 | 5.59 | 2.71 | 9.81 | 5.49 | 2.83 | 9.40 | 5.34 | 2.86 |

Temp: Fahrenheit  
TC, SHC: kBtu/h  
PI: kW

| INDOOR |      | OUTDOOR TEMPERATURE (°FDB) |       |      |       |       |      |       |       |      |       |       |      |       |       |      |       |       |      |
|--------|------|----------------------------|-------|------|-------|-------|------|-------|-------|------|-------|-------|------|-------|-------|------|-------|-------|------|
| EWB    | EDB  | 68                         |       |      | 77    |       |      | 86    |       |      | 90    |       |      | 95    |       |      | 104   |       |      |
| °F     | °F   | TC                         | SHC   | PI   | TC    | SHC   | PI   | TC    | SHC   | PI   | TC    | SHC   | PI   | TC    | SHC   | PI   | TC    | SHC   | PI   |
| 57.2   | 68.0 | 23.61                      | 16.97 | 1.38 | 23.61 | 16.97 | 1.61 | 23.61 | 16.97 | 1.88 | 23.61 | 16.97 | 2.00 | 23.61 | 16.97 | 2.20 | 23.61 | 16.97 | 2.46 |
| 60.8   | 71.6 | 29.44                      | 19.09 | 1.85 | 29.44 | 19.09 | 2.18 | 29.35 | 19.04 | 2.57 | 28.79 | 18.75 | 2.66 | 27.95 | 18.31 | 2.78 | 26.55 | 17.61 | 2.81 |
| 64.4   | 77.0 | 33.53                      | 21.13 | 2.17 | 32.13 | 20.43 | 2.38 | 30.73 | 19.74 | 2.59 | 30.17 | 19.47 | 2.67 | 29.33 | 19.06 | 2.79 | 27.94 | 18.40 | 2.82 |
| 67.0   | 80.0 | 34.22                      | 21.94 | 2.18 | 32.82 | 21.26 | 2.39 | 31.42 | 20.59 | 2.59 | 30.86 | 20.33 | 2.68 | 30.00 | 19.94 | 2.80 | 28.63 | 19.30 | 2.83 |
| 71.6   | 86.0 | 36.29                      | 21.04 | 2.20 | 34.90 | 20.43 | 2.40 | 33.50 | 19.84 | 2.61 | 32.94 | 19.61 | 2.69 | 32.10 | 19.26 | 2.82 | 30.70 | 18.69 | 2.84 |
| 75.2   | 89.6 | 37.68                      | 20.37 | 2.21 | 36.28 | 19.82 | 2.42 | 34.88 | 19.28 | 2.62 | 34.32 | 19.06 | 2.71 | 33.48 | 18.74 | 2.83 | 32.09 | 18.22 | 2.86 |

#### Heating

|     |      |
|-----|------|
| AFR | 20.1 |
|-----|------|

Temp: Celsius  
TC, PI: kW

| INDOOR |  | OUTDOOR TEMPERATURE (°CWB) |      |      |      |      |      |      |      |       |      |       |      |
|--------|--|----------------------------|------|------|------|------|------|------|------|-------|------|-------|------|
| EDB    |  | -15                        |      | -10  |      | -5   |      | 0    |      | 6     |      | 10    |      |
| °C     |  | TC                         | PI   | TC   | PI   | TC   | PI   | TC   | PI   | TC    | PI   | TC    | PI   |
| 15.0   |  | 4.86                       | 2.51 | 6.17 | 2.68 | 6.82 | 2.77 | 9.17 | 3.62 | 10.55 | 3.81 | 11.47 | 3.94 |
| 21.1   |  | 4.56                       | 2.58 | 5.87 | 2.75 | 6.52 | 2.84 | 8.82 | 3.71 | 10.20 | 3.90 | 10.69 | 3.70 |
| 22.0   |  | 4.44                       | 2.61 | 5.75 | 2.78 | 6.40 | 2.87 | 8.68 | 3.74 | 10.01 | 3.89 | 10.01 | 3.34 |
| 24.0   |  | 4.32                       | 2.64 | 5.63 | 2.81 | 6.28 | 2.89 | 8.54 | 3.78 | 9.33  | 3.49 | 9.33  | 3.01 |
| 25.0   |  | 4.26                       | 2.65 | 5.57 | 2.82 | 6.22 | 2.91 | 8.47 | 3.80 | 8.99  | 3.30 | 8.99  | 2.86 |
| 27.0   |  | 4.14                       | 2.68 | 5.45 | 2.85 | 6.10 | 2.94 | 8.31 | 3.82 | 8.31  | 2.94 | 8.31  | 2.56 |

Temp: Fahrenheit  
TC: kBtu/h  
PI: kW

| INDOOR |  | OUTDOOR TEMPERATURE (°FWB) |      |       |      |       |      |       |      |       |      |       |      |
|--------|--|----------------------------|------|-------|------|-------|------|-------|------|-------|------|-------|------|
| EDB    |  | 5                          |      | 14    |      | 23    |      | 32    |      | 43    |      | 50    |      |
| °F     |  | TC                         | PI   | TC    | PI   | TC    | PI   | TC    | PI   | TC    | PI   | TC    | PI   |
| 59.0   |  | 16.57                      | 2.51 | 21.05 | 2.68 | 23.25 | 2.77 | 31.29 | 3.62 | 36.00 | 3.81 | 39.15 | 3.94 |
| 70.0   |  | 15.55                      | 2.58 | 20.03 | 2.75 | 22.23 | 2.84 | 30.09 | 3.71 | 34.80 | 3.90 | 36.46 | 3.70 |
| 71.6   |  | 15.14                      | 2.61 | 19.62 | 2.78 | 21.82 | 2.87 | 29.61 | 3.74 | 34.15 | 3.89 | 34.15 | 3.34 |
| 75.2   |  | 14.74                      | 2.64 | 19.21 | 2.81 | 21.42 | 2.89 | 29.13 | 3.78 | 31.83 | 3.49 | 31.83 | 3.01 |
| 77.0   |  | 14.53                      | 2.65 | 19.01 | 2.82 | 21.21 | 2.91 | 28.89 | 3.80 | 30.67 | 3.30 | 30.67 | 2.86 |
| 80.6   |  | 14.12                      | 2.68 | 18.60 | 2.85 | 20.80 | 2.94 | 28.36 | 3.82 | 28.36 | 2.94 | 28.36 | 2.56 |



**Symbols:**

|     |                           |                        |
|-----|---------------------------|------------------------|
| AFR | : Airflow rate            | (m <sup>3</sup> /min.) |
| BF  | : Bypass factor           |                        |
| EWB | : Entering wet bulb temp. | (°C) / (°F)            |
| EDB | : Entering dry bulb temp. | (°C) / (°F)            |
| TC  | : Total capacity          | (kW) / (kBtu/h)        |
| SHC | : Sensible heat capacity  | (kW) / (kBtu/h)        |
| PI  | : Power input             | (kW)                   |

**Note:**

1. Ratings shown are net capacities which include a deduction for indoor fan motor heat.
2. ■ shows nominal (rated) capacities and power input.
3. TC, PI and SHC must be calculated by interpolation using the figures in the tables. (Figures out of the tables should not be used for calculation.)
4. SHC values not included in the table must be calculated using interpolation with values of direct proportion.
5. Capacities are based on the following conditions.  
Corresponding refrigerant piping length : 25 ft  
Level difference : 0 ft
6. Cooling capacity at -15°CDB and 5°FDB.

Temp: Celsius  
TC, SHC, PI: kW  
60 Hz, 208 - 230 V

| INDOOR |      | OUTDOOR    |      |      |
|--------|------|------------|------|------|
| EWB    | EDB  | -15 (°CDB) |      |      |
| °C     | °C   | TC         | SHC  | PI   |
| 14.0   | 20.0 | 5.49       | 4.28 | 0.49 |

Temp: Fahrenheit  
TC, SHC: kBtu/h  
PI: kW  
60 Hz, 208 - 230 V

| INDOOR |      | OUTDOOR  |       |      |
|--------|------|----------|-------|------|
| EWB    | EDB  | 5 (°FDB) |       |      |
| °F     | °F   | TC       | SHC   | PI   |
| 57.2   | 68.0 | 18.73    | 14.59 | 0.49 |

3D063318A

**FTXS36LVJU + RXS36LVJU**

<60 Hz, 208 V>

**Cooling**

|     |      |
|-----|------|
| AFR | 21.8 |
| BF  | 0.27 |

Temp: Celsius  
TC, SHC, PI: kW

| INDOOR |      | OUTDOOR TEMPERATURE (°CDB) |      |      |       |      |      |       |      |      |       |      |      |       |      |      |       |      |      |
|--------|------|----------------------------|------|------|-------|------|------|-------|------|------|-------|------|------|-------|------|------|-------|------|------|
| EWB    | EDB  | 20                         |      |      | 25    |      |      | 30    |      |      | 32    |      |      | 35    |      |      | 40    |      |      |
| °C     | °C   | TC                         | SHC  | PI   | TC    | SHC  | PI   | TC    | SHC  | PI   | TC    | SHC  | PI   | TC    | SHC  | PI   | TC    | SHC  | PI   |
| 14.0   | 20.0 | 7.15                       | 5.14 | 1.53 | 7.15  | 5.14 | 1.77 | 7.15  | 5.14 | 2.05 | 7.15  | 5.14 | 2.17 | 7.15  | 5.14 | 2.38 | 7.15  | 5.14 | 2.67 |
| 16.0   | 22.0 | 8.92                       | 5.78 | 2.07 | 8.92  | 5.78 | 2.43 | 8.92  | 5.78 | 2.86 | 8.92  | 5.78 | 3.07 | 8.92  | 5.78 | 3.42 | 8.66  | 5.65 | 3.83 |
| 18.0   | 25.0 | 10.82                      | 6.74 | 2.78 | 10.82 | 6.74 | 3.33 | 10.44 | 6.54 | 3.70 | 10.25 | 6.45 | 3.81 | 9.97  | 6.30 | 3.99 | 9.10  | 5.88 | 3.83 |
| 19.4   | 26.7 | 11.62                      | 7.28 | 3.11 | 11.15 | 7.03 | 3.41 | 10.67 | 6.80 | 3.70 | 10.48 | 6.70 | 3.82 | 10.20 | 6.56 | 4.00 | 9.32  | 6.14 | 3.83 |
| 22.0   | 30.0 | 12.33                      | 6.97 | 3.14 | 11.85 | 6.75 | 3.44 | 11.38 | 6.54 | 3.73 | 11.19 | 6.46 | 3.85 | 10.90 | 6.33 | 4.03 | 9.98  | 5.94 | 3.83 |
| 24.0   | 32.0 | 12.80                      | 6.74 | 3.16 | 12.32 | 6.54 | 3.45 | 11.85 | 6.35 | 3.75 | 11.66 | 6.27 | 3.87 | 11.37 | 6.15 | 4.04 | 10.41 | 5.78 | 3.83 |

Temp: Fahrenheit  
TC, SHC: kBtu/h  
PI: kW

| INDOOR |      | OUTDOOR TEMPERATURE (°FDB) |       |      |       |       |      |       |       |      |       |       |      |       |       |      |       |       |      |
|--------|------|----------------------------|-------|------|-------|-------|------|-------|-------|------|-------|-------|------|-------|-------|------|-------|-------|------|
| EWB    | EDB  | 68                         |       |      | 77    |       |      | 86    |       |      | 90    |       |      | 95    |       |      | 104   |       |      |
| °F     | °F   | TC                         | SHC   | PI   | TC    | SHC   | PI   | TC    | SHC   | PI   | TC    | SHC   | PI   | TC    | SHC   | PI   | TC    | SHC   | PI   |
| 57.2   | 68.0 | 24.39                      | 17.54 | 1.53 | 24.39 | 17.54 | 1.77 | 24.39 | 17.54 | 2.05 | 24.39 | 17.54 | 2.17 | 24.39 | 17.54 | 2.38 | 24.39 | 17.54 | 2.67 |
| 60.8   | 71.6 | 30.43                      | 19.72 | 2.07 | 30.43 | 19.72 | 2.43 | 30.43 | 19.72 | 2.86 | 30.43 | 19.72 | 3.07 | 30.43 | 19.72 | 3.42 | 29.55 | 19.27 | 3.83 |
| 64.4   | 77.0 | 36.91                      | 23.00 | 2.78 | 36.91 | 23.00 | 3.33 | 35.62 | 22.33 | 3.70 | 34.97 | 22.00 | 3.81 | 34.00 | 21.51 | 3.99 | 31.05 | 20.05 | 3.83 |
| 67.0   | 80.0 | 39.66                      | 24.83 | 3.11 | 38.04 | 24.00 | 3.41 | 36.42 | 23.19 | 3.70 | 35.77 | 22.87 | 3.82 | 35.00 | 22.39 | 4.00 | 31.79 | 20.96 | 3.83 |
| 71.6   | 86.0 | 42.07                      | 23.78 | 3.14 | 40.45 | 23.04 | 3.44 | 38.83 | 22.32 | 3.73 | 38.18 | 22.03 | 3.85 | 37.21 | 21.61 | 4.03 | 34.04 | 20.26 | 3.83 |
| 75.2   | 89.6 | 43.67                      | 23.00 | 3.16 | 42.05 | 22.32 | 3.45 | 40.43 | 21.65 | 3.75 | 39.78 | 21.39 | 3.87 | 38.81 | 21.00 | 4.04 | 35.53 | 19.72 | 3.83 |

**Heating**

|     |      |
|-----|------|
| AFR | 22.9 |
|-----|------|

Temp: Celsius  
TC, PI: kW

| INDOOR |  | OUTDOOR TEMPERATURE (°CWB) |      |      |      |      |      |      |      |       |      |       |      |
|--------|--|----------------------------|------|------|------|------|------|------|------|-------|------|-------|------|
| EDB    |  | -15                        |      | -10  |      | -5   |      | 0    |      | 6     |      | 10    |      |
| °C     |  | TC                         | PI   | TC   | PI   | TC   | PI   | TC   | PI   | TC    | PI   | TC    | PI   |
| 15.0   |  | 5.00                       | 2.45 | 6.01 | 2.57 | 7.02 | 2.70 | 9.44 | 3.53 | 10.86 | 3.71 | 11.81 | 3.84 |
| 21.1   |  | 4.69                       | 2.51 | 5.70 | 2.64 | 6.71 | 2.76 | 9.08 | 3.61 | 10.50 | 3.80 | 11.45 | 3.93 |
| 22.0   |  | 4.57                       | 2.54 | 5.58 | 2.67 | 6.58 | 2.79 | 8.93 | 3.65 | 10.36 | 3.83 | 11.30 | 3.96 |
| 24.0   |  | 4.45                       | 2.57 | 5.45 | 2.69 | 6.46 | 2.82 | 8.79 | 3.68 | 10.21 | 3.87 | 11.16 | 3.99 |
| 25.0   |  | 4.38                       | 2.58 | 5.39 | 2.71 | 6.40 | 2.83 | 8.71 | 3.70 | 10.14 | 3.89 | 10.97 | 3.92 |
| 27.0   |  | 4.26                       | 2.61 | 5.27 | 2.74 | 6.28 | 2.86 | 8.57 | 3.73 | 9.99  | 3.92 | 10.15 | 3.45 |

Temp: Fahrenheit  
TC: kBtu/h  
PI: kW

| INDOOR |  | OUTDOOR TEMPERATURE (°FWB) |      |       |      |       |      |       |      |       |      |       |      |
|--------|--|----------------------------|------|-------|------|-------|------|-------|------|-------|------|-------|------|
| EDB    |  | 5                          |      | 14    |      | 23    |      | 32    |      | 43    |      | 50    |      |
| °F     |  | TC                         | PI   | TC    | PI   | TC    | PI   | TC    | PI   | TC    | PI   | TC    | PI   |
| 59.0   |  | 17.06                      | 2.45 | 20.50 | 2.57 | 23.94 | 2.70 | 32.21 | 3.53 | 37.06 | 3.71 | 40.30 | 3.84 |
| 70.0   |  | 16.01                      | 2.51 | 19.45 | 2.64 | 22.89 | 2.76 | 30.97 | 3.61 | 36.00 | 3.80 | 39.06 | 3.93 |
| 71.6   |  | 15.59                      | 2.54 | 19.03 | 2.67 | 22.47 | 2.79 | 30.48 | 3.65 | 35.33 | 3.83 | 38.57 | 3.96 |
| 75.2   |  | 15.17                      | 2.57 | 18.61 | 2.69 | 22.05 | 2.82 | 29.98 | 3.68 | 34.84 | 3.87 | 38.07 | 3.99 |
| 77.0   |  | 14.96                      | 2.58 | 18.40 | 2.71 | 21.84 | 2.83 | 29.73 | 3.70 | 34.59 | 3.89 | 37.44 | 3.92 |
| 80.6   |  | 14.54                      | 2.61 | 17.98 | 2.74 | 21.42 | 2.86 | 29.24 | 3.73 | 34.09 | 3.92 | 34.62 | 3.45 |

## &lt;60 Hz, 230 V&gt;

## Cooling

|     |      |
|-----|------|
| AFR | 21.8 |
| BF  | 0.27 |

Temp: Celsius  
TC, SHC, PI: kW

| INDOOR |      | OUTDOOR TEMPERATURE (°CDB) |      |      |       |      |      |       |      |      |       |      |      |       |      |      |       |      |      |
|--------|------|----------------------------|------|------|-------|------|------|-------|------|------|-------|------|------|-------|------|------|-------|------|------|
| EWB    | EDB  | 20                         |      |      | 25    |      |      | 30    |      |      | 32    |      |      | 35    |      |      | 40    |      |      |
| °C     | °C   | TC                         | SHC  | PI   | TC    | SHC  | PI   | TC    | SHC  | PI   | TC    | SHC  | PI   | TC    | SHC  | PI   | TC    | SHC  | PI   |
| 14.0   | 20.0 | 7.15                       | 5.14 | 1.54 | 7.15  | 5.14 | 1.77 | 7.15  | 5.14 | 2.05 | 7.15  | 5.14 | 2.17 | 7.15  | 5.14 | 2.38 | 7.15  | 5.14 | 2.67 |
| 16.0   | 22.0 | 8.92                       | 5.78 | 2.09 | 8.92  | 5.78 | 2.44 | 8.92  | 5.78 | 2.87 | 8.92  | 5.78 | 3.07 | 8.92  | 5.78 | 3.41 | 8.92  | 5.78 | 3.89 |
| 18.0   | 25.0 | 10.82                      | 6.74 | 2.80 | 10.82 | 6.74 | 3.35 | 10.75 | 6.70 | 3.97 | 10.55 | 6.60 | 4.10 | 10.26 | 6.45 | 4.29 | 9.60  | 6.12 | 4.24 |
| 19.4   | 26.7 | 11.82                      | 7.38 | 3.25 | 11.48 | 7.20 | 3.66 | 10.99 | 6.95 | 3.98 | 10.79 | 6.86 | 4.11 | 10.50 | 6.71 | 4.30 | 9.82  | 6.38 | 4.24 |
| 22.0   | 30.0 | 12.69                      | 7.14 | 3.37 | 12.20 | 6.91 | 3.69 | 11.71 | 6.69 | 4.01 | 11.52 | 6.60 | 4.14 | 11.23 | 6.47 | 4.33 | 10.50 | 6.16 | 4.24 |
| 24.0   | 32.0 | 13.18                      | 6.90 | 3.39 | 12.69 | 6.69 | 3.71 | 12.20 | 6.49 | 4.03 | 12.00 | 6.41 | 4.16 | 11.71 | 6.29 | 4.35 | 10.95 | 5.99 | 4.24 |

Temp: Fahrenheit  
TC, SHC: kBtu/h  
PI: kW

| INDOOR |      | OUTDOOR TEMPERATURE (°FDB) |       |      |       |       |      |       |       |      |       |       |      |       |       |      |       |       |      |
|--------|------|----------------------------|-------|------|-------|-------|------|-------|-------|------|-------|-------|------|-------|-------|------|-------|-------|------|
| EWB    | EDB  | 68                         |       |      | 77    |       |      | 86    |       |      | 90    |       |      | 95    |       |      | 104   |       |      |
| °F     | °F   | TC                         | SHC   | PI   | TC    | SHC   | PI   | TC    | SHC   | PI   | TC    | SHC   | PI   | TC    | SHC   | PI   | TC    | SHC   | PI   |
| 57.2   | 68.0 | 24.39                      | 17.54 | 1.54 | 24.39 | 17.54 | 1.77 | 24.39 | 17.54 | 2.05 | 24.39 | 17.54 | 2.17 | 24.39 | 17.54 | 2.38 | 24.39 | 17.54 | 2.67 |
| 60.8   | 71.6 | 30.43                      | 19.72 | 2.09 | 30.43 | 19.72 | 2.44 | 30.43 | 19.72 | 2.87 | 30.43 | 19.72 | 3.07 | 30.43 | 19.72 | 3.41 | 30.43 | 19.72 | 3.89 |
| 64.4   | 77.0 | 36.91                      | 23.00 | 2.80 | 36.91 | 23.00 | 3.35 | 36.67 | 22.87 | 3.97 | 36.00 | 22.52 | 4.10 | 35.00 | 22.01 | 4.29 | 32.75 | 20.89 | 4.24 |
| 67.0   | 80.0 | 40.33                      | 25.18 | 3.25 | 39.16 | 24.57 | 3.66 | 37.49 | 23.72 | 3.98 | 36.83 | 23.39 | 4.11 | 36.00 | 22.89 | 4.30 | 33.52 | 21.78 | 4.24 |
| 71.6   | 86.0 | 43.31                      | 24.36 | 3.37 | 41.64 | 23.58 | 3.69 | 39.97 | 22.83 | 4.01 | 39.30 | 22.53 | 4.14 | 38.30 | 22.09 | 4.33 | 35.82 | 21.01 | 4.24 |
| 75.2   | 89.6 | 44.96                      | 23.54 | 3.39 | 43.29 | 22.83 | 3.71 | 41.62 | 22.14 | 4.03 | 40.95 | 21.86 | 4.16 | 39.95 | 21.46 | 4.35 | 37.35 | 20.43 | 4.24 |

## Heating

|     |      |
|-----|------|
| AFR | 22.9 |
|-----|------|

Temp: Celsius  
TC, PI: kW

| INDOOR |  | OUTDOOR TEMPERATURE (°CWB) |      |      |      |      |      |      |      |       |      |       |      |
|--------|--|----------------------------|------|------|------|------|------|------|------|-------|------|-------|------|
| EDB    |  | -15                        |      | -10  |      | -5   |      | 0    |      | 6     |      | 10    |      |
| °C     |  | TC                         | PI   | TC   | PI   | TC   | PI   | TC   | PI   | TC    | PI   | TC    | PI   |
| 15.0   |  | 5.29                       | 2.70 | 6.35 | 2.84 | 7.42 | 2.98 | 9.98 | 3.90 | 11.48 | 4.11 | 12.49 | 4.24 |
| 21.1   |  | 4.96                       | 2.78 | 6.03 | 2.92 | 7.09 | 3.06 | 9.60 | 3.99 | 11.10 | 4.20 | 12.10 | 4.34 |
| 22.0   |  | 4.83                       | 2.81 | 5.90 | 2.95 | 6.96 | 3.09 | 9.44 | 4.03 | 10.95 | 4.24 | 11.95 | 4.38 |
| 24.0   |  | 4.70                       | 2.84 | 5.77 | 2.98 | 6.83 | 3.12 | 9.29 | 4.07 | 10.79 | 4.28 | 11.39 | 4.08 |
| 25.0   |  | 4.63                       | 2.85 | 5.70 | 2.99 | 6.77 | 3.13 | 9.21 | 4.09 | 10.72 | 4.29 | 10.97 | 3.83 |
| 27.0   |  | 4.50                       | 2.88 | 5.57 | 3.02 | 6.64 | 3.16 | 9.06 | 4.12 | 10.15 | 3.96 | 10.15 | 3.37 |

Temp: Fahrenheit  
TC: kBtu/h  
PI: kW

| INDOOR |  | OUTDOOR TEMPERATURE (°FWB) |      |       |      |       |      |       |      |       |      |       |      |
|--------|--|----------------------------|------|-------|------|-------|------|-------|------|-------|------|-------|------|
| EDB    |  | 5                          |      | 14    |      | 23    |      | 32    |      | 43    |      | 50    |      |
| °F     |  | TC                         | PI   | TC    | PI   | TC    | PI   | TC    | PI   | TC    | PI   | TC    | PI   |
| 59.0   |  | 18.04                      | 2.70 | 21.67 | 2.84 | 25.31 | 2.98 | 34.05 | 3.90 | 39.18 | 4.11 | 42.60 | 4.24 |
| 70.0   |  | 16.92                      | 2.78 | 20.56 | 2.92 | 24.20 | 3.06 | 32.74 | 3.99 | 38.00 | 4.20 | 41.29 | 4.34 |
| 71.6   |  | 16.48                      | 2.81 | 20.12 | 2.95 | 23.75 | 3.09 | 32.22 | 4.03 | 37.35 | 4.24 | 40.77 | 4.38 |
| 75.2   |  | 16.04                      | 2.84 | 19.67 | 2.98 | 23.31 | 3.12 | 31.70 | 4.07 | 36.83 | 4.28 | 38.86 | 4.08 |
| 77.0   |  | 15.81                      | 2.85 | 19.45 | 2.99 | 23.08 | 3.13 | 31.43 | 4.09 | 36.57 | 4.29 | 37.44 | 3.83 |
| 80.6   |  | 15.37                      | 2.88 | 19.00 | 3.02 | 22.64 | 3.16 | 30.91 | 4.12 | 34.62 | 3.96 | 34.62 | 3.37 |

**Symbols:**

|     |                           |                        |
|-----|---------------------------|------------------------|
| AFR | : Airflow rate            | (m <sup>3</sup> /min.) |
| BF  | : Bypass factor           |                        |
| EWB | : Entering wet bulb temp. | (°C) / (°F)            |
| EDB | : Entering dry bulb temp. | (°C) / (°F)            |
| TC  | : Total capacity          | (kW) / (kBtu/h)        |
| SHC | : Sensible heat capacity  | (kW) / (kBtu/h)        |
| PI  | : Power input             | (kW)                   |

**Note:**

1. Ratings shown are net capacities which include a deduction for indoor fan motor heat.
2. ■ shows nominal (rated) capacities and power input.
3. TC, PI and SHC must be calculated by interpolation using the figures in the tables. (Figures out of the tables should not be used for calculation.)
4. SHC values not included in the table must be calculated using interpolation with values of direct proportion.
5. Capacities are based on the following conditions.  
Corresponding refrigerant piping length : 25 ft  
Level difference : 0 ft
6. Cooling capacity at -15°CDB and 5°FDB.

Temp: Celsius  
TC, SHC, PI: kW  
60 Hz, 208 - 230 V

| INDOOR |      | OUTDOOR    |      |      |
|--------|------|------------|------|------|
| EWB    | EDB  | -15 (°CDB) |      |      |
| °C     | °C   | TC         | SHC  | PI   |
| 14.0   | 20.0 | 5.67       | 4.42 | 0.54 |

Temp: Fahrenheit  
TC, SHC: kBtu/h  
PI: kW  
60 Hz, 208 - 230 V

| INDOOR |      | OUTDOOR  |       |      |
|--------|------|----------|-------|------|
| EWB    | EDB  | 5 (°FDB) |       |      |
| °F     | °F   | TC       | SHC   | PI   |
| 57.2   | 68.0 | 19.35    | 15.08 | 0.54 |

3D063319A

### 7.3 Capacity correction factor by the length of refrigerant piping (Reference)

The cooling capacity and the heating capacity of the unit have to be corrected in accordance with the length of refrigerant piping — the distance between the indoor unit and the outdoor unit.

<— line : cooling capacity>

<--- line : heating capacity>

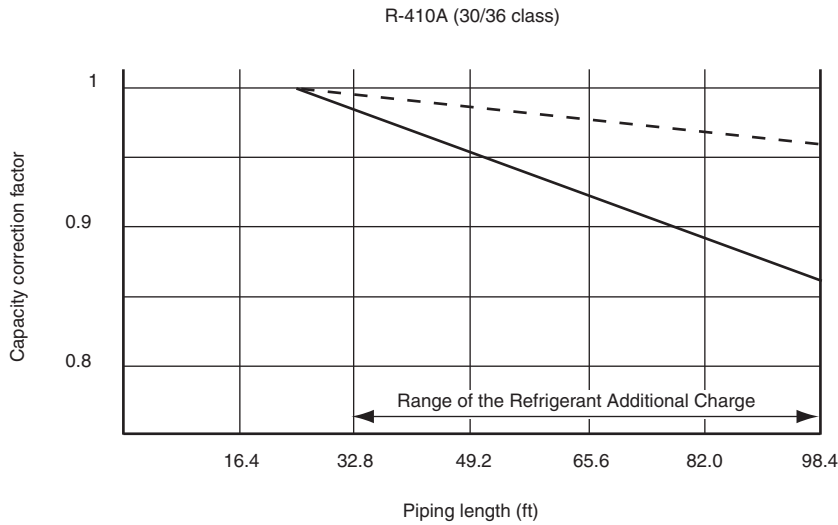

**NOTES:**

1. Cut the jumper on the outdoor unit PCB to expand the operation range down to 14°F.
2. Operation can be extended down to 0°F with use of the optional wind baffle.

(R4981)

**Note:**

The graph shows the factor when additional refrigerant of the proper quantity is charged.

# 8. Operation Limit

RKS30/36LVJU

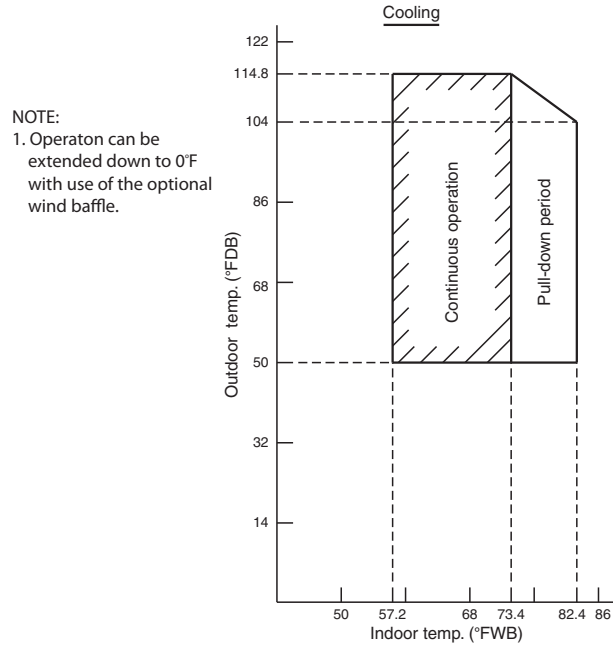

NOTE:  
1. Operaton can be extended down to 0°F with use of the optional wind baffle.

Note:  
The graphs are based on the following conditions.  
· Equivalent piping length 25ft  
· Level difference 0ft  
· Airflow rate High

4D074492

RXS30/36LVJU

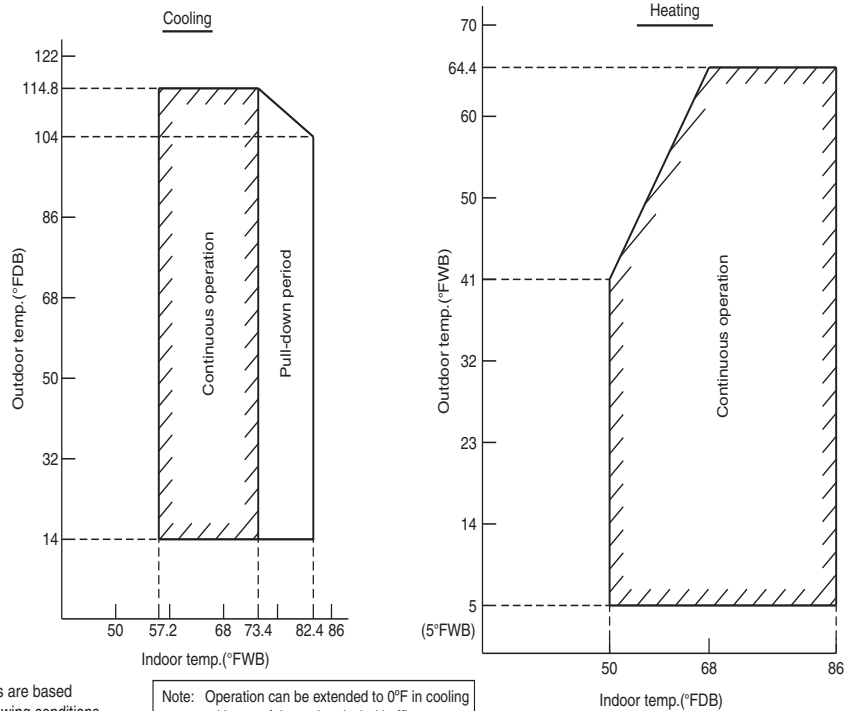

The graphs are based on the following conditions.  
· Equivalent piping length 25ft  
· Level difference 0m  
· Air flow rate High

Note: Operation can be extended to 0°F in cooling with use of the optional wind baffle.

# 9. Sound Level

## 9.1 Measuring Location

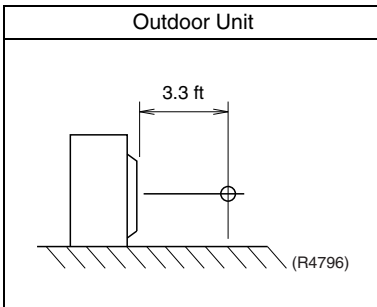
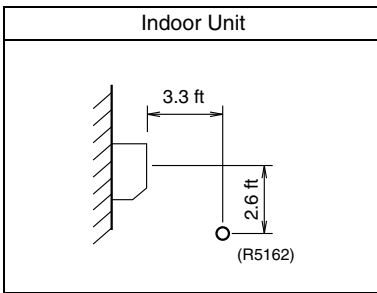

**Notes:**

1. Operation sound is measured in an anechoic chamber.
2. The data are based on the conditions shown in the table below.

| Cooling   | Heating   | Piping Length |
|---|---|---------------|
| Indoor ; 80°FDB (26.7°CDB) /<br>67°FWB (19.4°CWB)<br>Outdoor ; 95°FDB (35°CDB) /<br>75°FWB (24°CWB) | Indoor ; 70°FDB (21.1°CDB) /<br>60°FWB (15.6°CWB)<br>Outdoor ; 47°FDB (8.3°CDB) /<br>43°FWB (6°CWB) | 16.4 ft       |

## 9.2 Octave Band Level

### 9.2.1 Indoor Unit

#### FTXS30LVJU

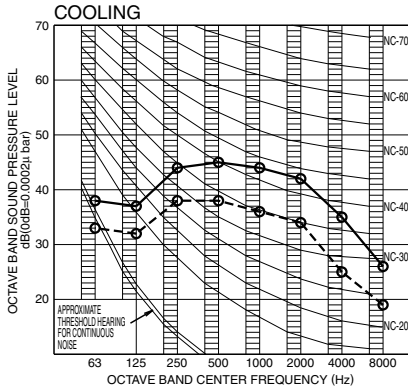

| OVER ALL (dB) |                   |                   |
|---------------|-------------------|-------------------|
| SCALE         | 60Hz 208/230V (H) | 60Hz 208/230V (L) |
| A             | 47                | 40                |

( B.G.N IS ALREADY RECTIFIED )

OPERATING CONDITIONS

POWER SOURCE 208/230V 60Hz

JIS STANDARD

○—○ 60Hz 208/230V(H)  
○- -○ 60Hz 208/230V(L)  
Cooling

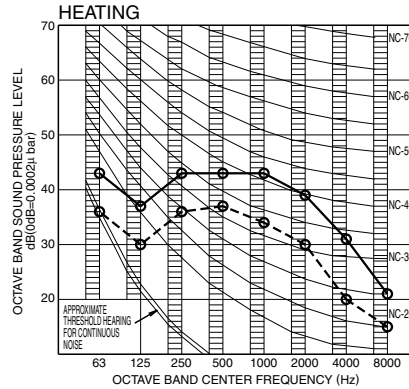

| OVER ALL (dB) |                   |                   |
|---------------|-------------------|-------------------|
| SCALE         | 60Hz 208/230V (H) | 60Hz 208/230V (L) |
| A             | 47                | 38                |

( B.G.N IS ALREADY RECTIFIED )

OPERATING CONDITIONS

POWER SOURCE 208/230V 60Hz

JIS STANDARD

○—○ 60Hz 208/230V(H)  
○- -○ 60Hz 208/230V(L)  
Heating

C: 3D062991A

#### FTXS36LVJU

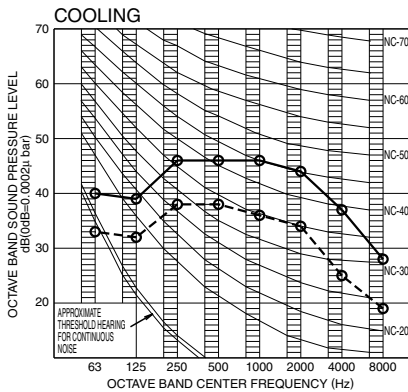

| OVER ALL (dB) |                   |                   |
|---------------|-------------------|-------------------|
| SCALE         | 60Hz 208/230V (H) | 60Hz 208/230V (L) |
| A             | 49                | 40                |

( B.G.N IS ALREADY RECTIFIED )

OPERATING CONDITIONS

POWER SOURCE 208/230V 60Hz

JIS STANDARD

○—○ 60Hz 208/230V(H)  
○- -○ 60Hz 208/230V(L)  
Cooling

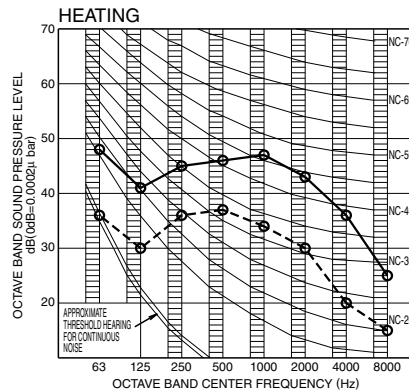

| OVER ALL (dB) |                   |                   |
|---------------|-------------------|-------------------|
| SCALE         | 60Hz 208/230V (H) | 60Hz 208/230V (L) |
| A             | 49                | 38                |

( B.G.N IS ALREADY RECTIFIED )

OPERATING CONDITIONS

POWER SOURCE 208/230V 60Hz

JIS STANDARD

○—○ 60Hz 208/230V(H)  
○- -○ 60Hz 208/230V(L)  
Heating

C: 3D062992A

### 9.2.2 Outdoor Unit

#### RKS30/36LVJU

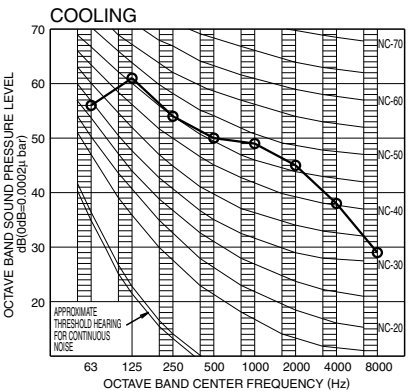

| OVER ALL (dB) |                |
|---------------|----------------|
| SCALE         | 208V-230V 60Hz |
| A             | 54             |

( B.G.N IS ALREADY RECTIFIED )

OPERATING CONDITIONS

POWER SOURCE 208-230V 60Hz

JIS STANDARD(JIS9612)

○—○ Cooling

C: 4D071133A

#### RXS30/36LVJU

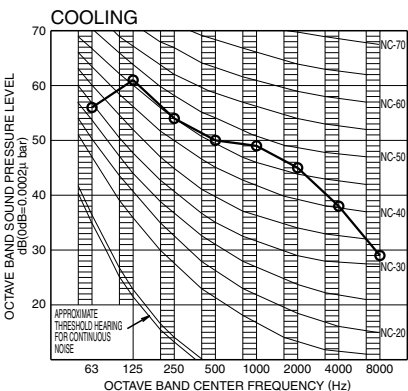

| OVER ALL (dB) |                |
|---------------|----------------|
| SCALE         | 208V-230V 60Hz |
| A             | 54             |

( B.G.N IS ALREADY RECTIFIED )

OPERATING CONDITIONS

POWER SOURCE 208-230V 60Hz

JIS STANDARD(JIS9612)

○—○ Cooling

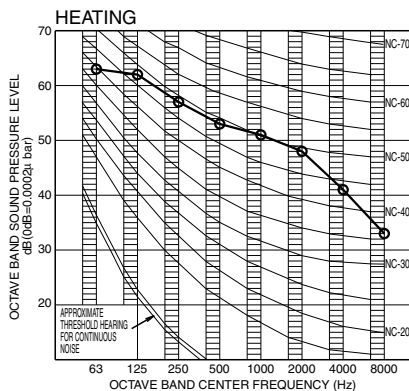

| OVER ALL (dB) |                |
|---------------|----------------|
| SCALE         | 208V-230V 60Hz |
| A             | 55             |

( B.G.N IS ALREADY RECTIFIED )

OPERATING CONDITIONS

POWER SOURCE 208-230V 60Hz

JIS STANDARD(JIS9612)

○—○ Heating

C: 3D063288A



## 10. Electric Characteristics

| Indoor Unit | Outdoor Unit | Power Supply |  |      |     | COMP |      | OFM |      | IFM |      |
|-------------|--------------|--------------|--|------|-----|------|------|-----|------|-----|------|
|             |              | Hz - Volts   | Voltage Range                          | MCA  | MFA | RHz  | RLA  | W   | FLA  | W   | FLA  |
| FTXS30LVJU  | RKS30LVJU    | 60 - 208     | MAX. 60 Hz, 253 V<br>MIN. 60 Hz, 187 V | 19.5 | 20  | 66   | 13.5 | 200 | 0.39 | 64  | 0.37 |
|             |              | 60 - 230     |  |      |     |      | 12.2 |     | 0.35 |     | 0.34 |
| FTXS36LVJU  | RKS36LVJU    | 60 - 208     | MAX. 60 Hz, 253 V<br>MIN. 60 Hz, 187 V | 19.5 | 20  | 84   | 18.9 | 200 | 0.39 | 64  | 0.37 |
|             |              | 60 - 230     |  |      |     |      | 90   |     | 18.4 |     | 0.35 |
| FTXS30LVJU  | RXS30LVJU    | 60 - 208     | MAX. 60 Hz, 253 V<br>MIN. 60 Hz, 187 V | 19.5 | 20  | 66   | 18.1 | 200 | 0.39 | 64  | 0.37 |
|             |              | 60 - 230     |  |      |     |      | 16.4 |     | 0.35 |     | 0.34 |
| FTXS36LVJU  | RXS36LVJU    | 60 - 208     | MAX. 60 Hz, 253 V<br>MIN. 60 Hz, 187 V | 19.5 | 20  | 84   | 20.3 | 200 | 0.39 | 64  | 0.37 |
|             |              | 60 - 230     |  |      |     |      | 90   |     | 18.4 |     | 0.35 |

### Symbols:

MCA : Min. circuit amps (A)  
 MFA : Max. fuse amps (A)  
 RHz : Rated operating frequency (Hz)  
 RLA : Rated load amps (A)  
 OFM : Outdoor fan motor  
 IFM : Indoor fan motor  
 W : Fan motor rated output (W)  
 FLA : Full load amps (A)

### Notes:

1. RLA is based on the following conditions.  
 Indoor temp. : 80°FDB / 67°FWB (26.7°CDB / 19.4°CWB)  
 Outdoor temp. : 95°FDB (35°CDB)
2. Maximum allowable voltage variation between phases is 2%.
3. Select wire size based on the larger value of MCA.

3D063167A  
 3D071271A

# 11. Installation Manual

## 11.1 Indoor Unit





### Safety Considerations

Read these ***SAFETY CONSIDERATIONS for Installation*** carefully before installing an air conditioner or heat pump. After completing the installation, make sure that the unit operates properly during the startup operation.

Instruct the customer on how to operate and maintain the unit. Inform customers that they should store this Installation Manual with the Operation Manual for future reference.

Always use a licensed installer or contractor to install this product. Improper installation can result in water or refrigerant leakage, electrical shock, fire, or explosion.

Meanings of **DANGER**, **WARNING**, **CAUTION**, and **NOTE** Symbols:

-  **DANGER** ..... Indicates an imminently hazardous situation which, if not avoided, will result in death or serious injury.
-  **WARNING** ..... Indicates a potentially hazardous situation which, if not avoided, could result in death or serious injury.
-  **CAUTION** ..... Indicates a potentially hazardous situation which, if not avoided, may result in minor or moderate injury. It may also be used to alert against unsafe practices.
-  **NOTE** ..... Indicates situations that may result in equipment or property-damage accidents only.

- **Refrigerant gas is heavier than air and replaces oxygen. A massive leak can lead to oxygen depletion, especially in basements, and an asphyxiation hazard could occur leading to serious injury or death.**
- **Do not ground units to water pipes, gas pipes, telephone wires, or lightning rods as incomplete grounding can cause a severe shock hazard resulting in severe injury or death. Additionally, grounding to gas pipes could cause a gas leak and potential explosion causing severe injury or death.**
- **If refrigerant gas leaks during installation, ventilate the area immediately. Refrigerant gas may produce toxic gas if it comes into contact with fire. Exposure to this gas could cause severe injury or death.**
- **After completing the installation work, check that the refrigerant gas does not leak throughout the system.**
- **Do not install unit in an area where flammable materials are present due to risk of explosions that can cause serious injury or death.**
- **Safely dispose all packing and transportation materials in accordance with federal/state/local laws or ordinances. Packing materials such as nails and other metal or wood parts, including plastic packing materials used for transportation may cause injuries or death by suffocation.**
- **Only qualified personnel must carry out the installation work. Installation must be done in accordance with this**

**installation manual. Improper installation may result in water leakage, electric shock, or fire.**

- **When installing the unit in a small room, take measures to keep the refrigerant concentration from exceeding allowable safety limits. Excessive refrigerant leaks, in the event of an accident in a closed ambient space, can lead to oxygen deficiency.**
- **Use only specified accessories and parts for installation work. Failure to use specified parts may result in water leakage, electric shocks, fire, or the unit falling.**
- **Install the air conditioner or heat pump on a foundation strong enough that it can withstand the weight of the unit. A foundation of insufficient strength may result in the unit falling and causing injuries.**
- **Take into account strong winds, typhoons, or earthquakes when installing. Improper installation may result in the unit falling and causing accidents.**
- **Make sure that a separate power supply circuit is provided for this unit and that all electrical work is carried out by qualified personnel according to local, state, and national regulations. An insufficient power supply capacity or improper electrical construction may lead to electric shocks or fire.**
- **Make sure that all wiring is secured, that specified wires are used, and that no external forces act on the terminal connections or wires. Improper connections or installation may result in fire.**
- **When wiring, position the wires so that the terminal box lid can be securely fastened. Improper positioning of the terminal box lid may result in electric shocks, fire, or the terminals overheating.**
- **Before touching electrical parts, turn off the unit.**
- **Securely fasten the outside unit terminal cover (panel). If the terminal cover/panel is not installed properly, dust or water may enter the outside unit causing fire or electric shock.**
- **When installing or relocating the system, keep the refrigerant circuit free from substances other than the specified refrigerant (R-410A) such as air. Any presence of air or other foreign substance in the refrigerant circuit can cause an abnormal pressure rise or rupture, resulting in injury.**
- **Do not change the setting of the protection devices. If the pressure switch, thermal switch, or other protection device is shorted and operated forcibly, or parts other than those specified by Daikin are used, fire or explosion may occur.**

- Do not touch the switch with wet fingers. Touching a switch with wet fingers can cause electric shock.
- Do not allow children to play on or around the unit to prevent injury.
- The heat exchanger fins are sharp enough to cut. To avoid injury wear gloves or cover the fins while working around them.
- Do not touch the refrigerant pipes during and immediately after operation as the refrigerant pipes may be hot or cold, depending on the condition of the refrigerant flowing through the refrigerant piping, compressor, and other refrigerant cycle parts. Your hands may suffer burns or frostbite if you touch the refrigerant pipes. To avoid injury, give the pipes time to return to normal temperature or, if you must touch them, be sure to wear proper gloves.
- Install drain piping to proper drainage. Improper drain piping may result in water leakage and property damage.
- Insulate piping to prevent condensation.
- Be careful when transporting the product.
- Do not turn off the power immediately after stopping operation. Always wait for at least 5 minutes before turning off the power. Otherwise, water leakage may occur.
- Do not use a charging cylinder. Using a charging cylinder may cause the refrigerant to deteriorate.
- Refrigerant R-410A in the system must be kept clean, dry, and tight.
  - (a) Clean and Dry -- Foreign materials (including mineral oils such as SUNISO oil or moisture) should be prevented from getting into the system.
  - (b) Tight -- R-410A does not contain any chlorine, does not destroy the ozone layer, and does not reduce the earth's protection against harmful ultraviolet radiation. R-410A can contribute to the greenhouse effect if it is released. Therefore take proper measures to check for the tightness of the refrigerant piping installation. Read the chapter *Refrigerant Piping* and follow the procedures.
- Since R-410A is a blend, the required additional refrigerant must be charged in its liquid state. If the refrigerant is charged in a state of gas, its composition can change and the system will not work properly.
- The indoor unit is for R-410A. See the catalog for indoor models that can be connected. Normal operation is not possible when connected to other units.
- Remote controller (wireless kit) transmitting distance can be shorter than expected in rooms with electronic fluorescent lamps (inverter or rapid start types). Install the indoor unit far away from fluorescent lamps as much as possible.
- Indoor units are for indoor installation only. Outdoor units can be installed either outdoors or indoors. This unit is for indoor use.
- Do not install the air conditioner or heat pump in the following locations:
  - (a) Where a mineral oil mist or oil spray or vapor is produced, for example, in a kitchen. Plastic parts may deteriorate and fall off or result in water leakage.
  - (b) Where corrosive gas, such as sulfurous acid gas, is produced. Corroding copper pipes or soldered parts may result in refrigerant leakage.
  - (c) Near machinery emitting electromagnetic waves. Electromagnetic waves may disturb the operation of the control system and cause the unit to malfunction.
  - (d) Where flammable gas may leak, where there is carbon fiber, or ignitable dust suspension in the air, or where volatile flammables such as thinner or gasoline are handled. Operating the unit in such conditions can cause a fire.
- Take adequate measures to prevent the outside unit from being used as a shelter by small animals. Small animals making contact with electrical parts can cause malfunctions, smoke, or fire. Instruct the customer to keep the area around the unit clean.
- Install the power supply and control wires for the indoor and outdoor units at least 3.5 feet away from televisions or radios to prevent image interference or noise. Depending on the radio waves, a distance of 3.5 feet may not be sufficient to eliminate the noise.
- Dismantling the unit, treatment of the refrigerant, oil and additional parts must be done in accordance with the relevant local, state, and national regulations.
- Do not use the following tools that are used with conventional refrigerants: gauge manifold, charge hose, gas leak detector, reverse flow check valve, refrigerant charge base, vacuum gauge, or refrigerant recovery equipment.
- If the conventional refrigerant and refrigerator oil are mixed in R-410A, the refrigerant may deteriorate.
- This air conditioner or heat pump is an appliance that should not be accessible to the general public.
- As design pressure is 478 psi, the wall thickness of field-installed pipes should be selected in accordance with the relevant local, state, and national regulations.

## Accessories

|   |   |   |   |                       |   |
|---|---|---|---|-----------------------|---|
| Ⓐ Mounting plate  | 1 | Ⓔ Remote controller holder  | 1 | Ⓙ Tube                | 1 |
| Ⓑ Mounting plate fixing screws<br>3/16" × 1"L (M4 × 25L)  | 9 | Ⓕ Fixing screws for remote controller<br>holder 1/8" × 13/16"L (M3 × 20L) | 2 | Ⓚ Operation manual    | 1 |
| Ⓒ Titanium Apatite Photocatalytic<br>Air-Purifying Filter | 3 | Ⓖ Dry batteries AAA. LR03<br>(alkaline)                                   | 2 | Ⓛ Installation manual | 1 |
| Ⓓ Wireless remote controller                              | 1 | Ⓗ Indoor unit fixing screws<br>3/16" × 1/2"L (M4 × 12L)                   | 3 | Ⓜ Screw cover         | 3 |

## Choosing an Installation Site

- Before choosing the installation site, obtain user approval.

### 1. Indoor unit.

- The indoor unit should be sited in a place where:
  - 1) the restrictions on installation specified in the indoor unit installation drawings are met
  - 2) both air intake and exhaust have clear paths met
  - 3) the unit is not in the path of direct sunlight
  - 4) the unit is away from the source of heat or steam
  - 5) there is no source of machine oil vapor (this may shorten indoor unit life)
  - 6) cool (warm) air is circulated throughout the room
  - 7) the unit is away from electronic ignition type fluorescent lamps (inverter or rapid start type) as they may shorten the remote controller range
  - 8) the unit is at least 3.5ft (1m) away from any television or radio set (unit may cause interference with the picture or sound)
  - 9) install at the recommended height of 6ft (1.8m)

### 2. Wireless remote controller.

- 1) Turn on all the fluorescent lamps in the room, if any, and find the site where remote controller signals are properly received by the indoor unit within 23ft (7m).
- 2) Make the DIP switch settings. Set according to the type of unit purchased by the customer. The default settings are on the heat pump side.

- **For cooling only** (Outdoor unit model: RKS)

Set the DIP switch on the cooling only side.

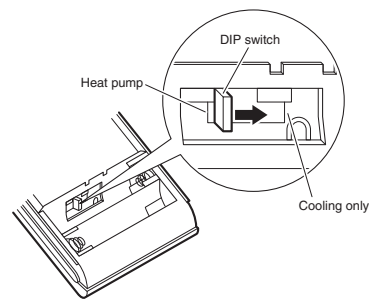

- **For heat pump** (Outdoor unit model: RXS)

Check that the DIP switch is on the heat pump side.

If they are set on the cooling only side, move them to the heat pump side.

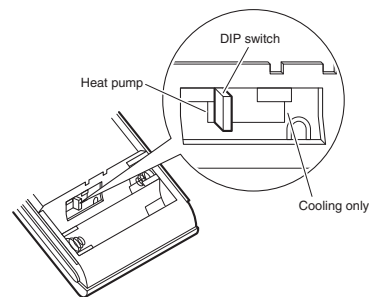

## Indoor Unit Installation Drawings

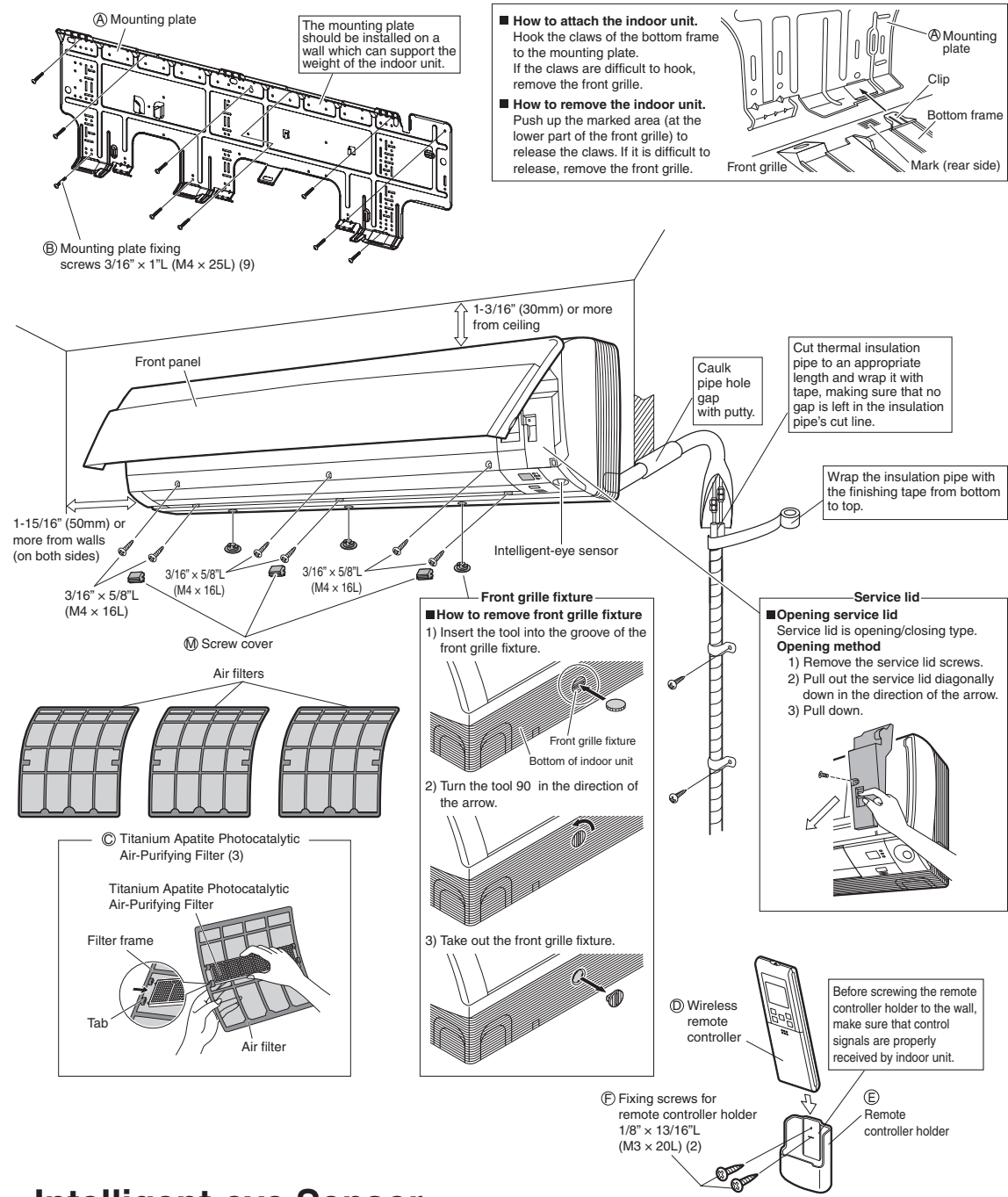

### Intelligent-eye Sensor

**⚠ CAUTION**

- 1) Do not hit or forcefully push the intelligent-eye sensor. This could lead to damage and malfunction.
- 2) Do not place large objects near the sensor. Keep heating units or humidifiers outside the sensor's detection area.

## Installation Tips

### 1. Removing and installing front panel.

**• Removal method**

Hook fingers on the panel protrusions on the left and right of the main body, and open until the panel stops. Slide the front panel sideways to disengage the rotating shaft. Then pull the front panel toward you to remove it.

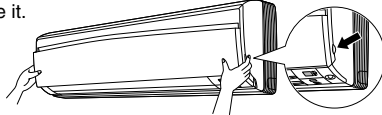

**• Installation method**

Align the tabs of the front panel with the grooves, and push all the way in. Then close slowly. Push the center of the lower surface of the panel firmly to engage the tabs.

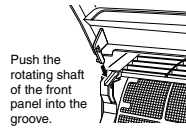

### 2. Removing and installing the front grille.

**• Removal method**

- 1) Remove front panel to remove the air filter.
- 2) Remove the front grille.
- 3) In front of the ○○○ mark of the front grille, there are 4 upper hooks. Lightly pull the front grille toward you with one hand, and push down on the hooks with the fingers of your other hand.

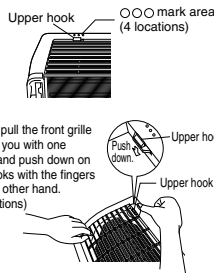

<When there is no work space because the unit is close to ceiling>

**⚠ CAUTION**

Be sure to wear protection gloves.

Place both hands under the center of the front grille, and while pushing up, pull it toward you.

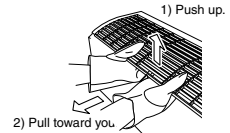

**• Installation method**

- 1) Install the front grille and firmly engage the upper hooks (4 locations).
- 2) Install 6 screws of the front grille.
- 3) Install the air filter and then mount the front panel.

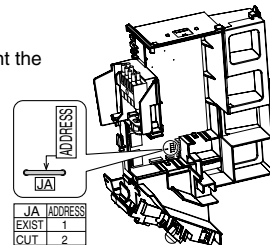

### 3. How to set the different addresses.

When 2 indoor units are installed in 1 room, the 2 wireless remote controllers can be set for different addresses.

- 1) In the same way as when connecting to an HA system, remove the metal plate electrical wiring cover.
- 2) Cut the address jumper (JA) on the printed circuit board.
- 3) Cut the address jumper (J4) in the remote controller.

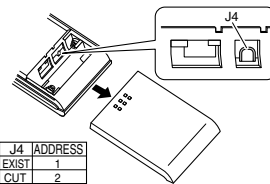

## Indoor Unit Installation (1)

### 1. Installing the mounting plate.

- The mounting plate should be installed on a wall which can support the weight of the indoor unit.
- 1) Temporarily secure the mounting plate to the wall, make sure that the panel is completely level, and mark the boring points on the wall.
- 2) Secure the mounting plate to the wall with screws.

**Recommended mounting plate retention spots and dimensions**

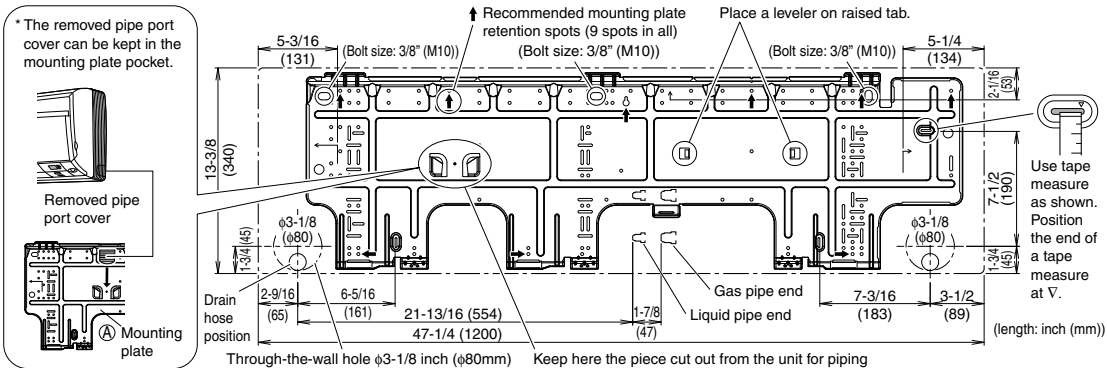

### 2. Boring a wall hole and installing wall embedded pipe.

- For walls containing metal frame or metal board, be sure to use a wall embedded pipe and wall cover in the feed-through hole to prevent possible heat, electrical shock, or fire.
- Be sure to caulk the gaps around the pipes with caulking material to prevent water leakage.
- 1) Bore a feed-through hole of 3-1/8 inch (80mm) in the wall so it has a down slope toward the outside.
- 2) Insert a wall pipe into the hole.
- 3) Insert a wall cover into wall pipe.
- 4) After completing refrigerant piping, wiring, and drain piping, caulk pipe hole gap with putty.

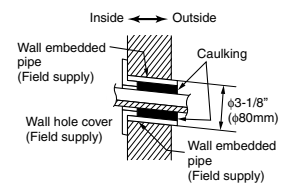

## Indoor Unit Installation (2)

### 3. Installing indoor unit.

#### 3-1. Right-side, right-back, or right-bottom piping.

- 1) Attach the drain hose to the underside of the refrigerant pipes with an adhesive vinyl tape.
- 2) Wrap the refrigerant pipes and drain hose together with an insulation tape.
- 3) Pass the drain hose and refrigerant pipes through the wall hole, then set the indoor unit on the mounting plate hooks by using the  $\Delta$  markings at the top of the indoor unit as a guide.
- 4) Open the front panel, then open the service lid. (Refer to Installation Tips.)
- 5) Pass the inter-unit wire from the outdoor unit through the feed-through wall hole and then through the back of the indoor unit. Pull them through the front side. Bend the ends of tie wires upward for easier work in advance. (If the inter-unit wire ends are to be stripped first, bundle wire ends with adhesive tape.)
- 6) Press the bottom frame of the indoor unit with both hands to set it on the mounting plate hooks. Make sure that the wires do not catch on the edge of the indoor unit.

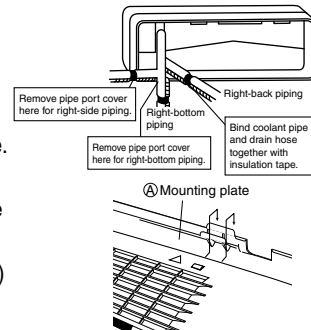

#### 3-2. Left-side, left-back, or left-bottom piping.

- 1) Attach the drain hose to the underside of the refrigerant pipes with adhesive vinyl tape.
- 2) Be sure to connect the drain hose to the drain port in place of a drain plug.

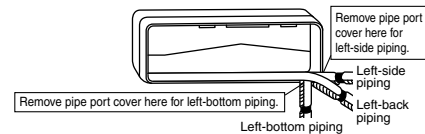

#### How to set the drain hose.

- Insert drain hose and tighten indoor unit fixing screw. (Forgetting to attach this may cause water leakages.)
- \* The drain hose is on the back of the unit.

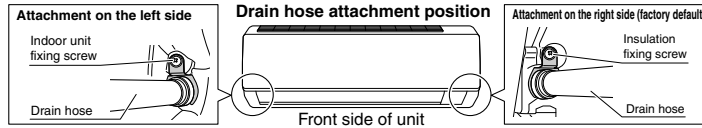

#### How to set the drain plug.

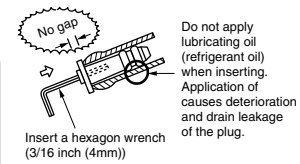

- 3) Shape the refrigerant pipe along the pipe path marking on the mounting plate.
- 4) Pass drain hose and refrigerant pipes through the wall hole, then set the indoor unit on mounting plate hooks, using the  $\Delta$  markings at the top of indoor unit as a guide.
- 5) Pull in the inter-unit wire.
- 6) Connect the inter-unit pipes.
- 7) Wrap the refrigerant pipes and drain hose together with insulation tape as right figure, in case of setting the drain hose through the back of the indoor unit.
- 8) While exercising care so that the inter-unit wire do not catch indoor unit, press the bottom edge of indoor unit with both hands until it is firmly caught by the mounting plate hooks. Secure indoor unit to the mounting plate with the screws ( $3/16" \times 1/2" L$  (M4  $\times$  12L)).

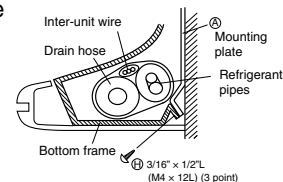
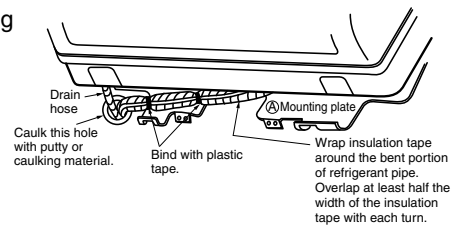

#### 3-3. Wall embedded piping.

Follow the instructions given under

#### Left-side, left-back, or left-bottom piping

- 1) Insert the drain hose to this depth so it won't be pulled out of the drain pipe.

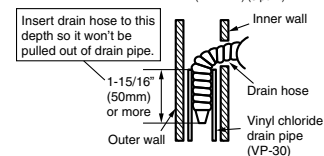

## Indoor Unit Installation (3)

### 4. Wiring.

- 1) As shown in the illustration on the right-hand side, insert the wires including the ground wire into the conduit and secure them with lock nut onto the conduit mounting plate.
- 2) Insert the wires including the ground wire into (J) tube.
- 3) Strip wire ends (9/16 inch (15mm)).
- 4) Match wire colors with terminal numbers on indoor and outdoor unit's terminal blocks and firmly screw wires to the corresponding terminals.
- 5) Connect the ground wires to the corresponding terminals.
- 6) Pull the wires and check that the wires are securely fixed to the terminal block.
- 7) In case of connecting to an adapter system, run the remote controller cable and attach the S21. (Refer to 5. When connecting to an HA system.)
- 8) Shape the wires so that the service lid fits securely, then close service lid.

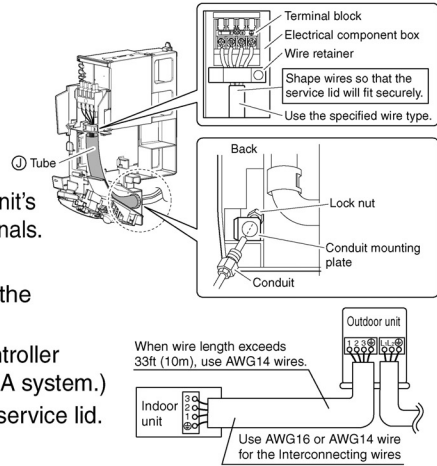

### ⚠ WARNING

- 1) Do not use tapped wires, stranded wires, extension cords, or starburst connections, as they may cause overheating, electrical shock, or fire.
- 2) Do not use locally purchased electrical parts inside the product. (Do not branch the power for the drain pump, etc., from the terminal block.) Doing so may cause electric shock or fire.
- 3) When carrying out wiring connection, take care not to pull at the conduit.
- 4) Do not connect the power wire to the indoor unit. Doing so may cause electric shock or fire.

### 5. When connecting to an HA system.

- 1) Remove the front grille. (6 screws, 3 front grille fixtures)
- 2) Remove the electrical wiring box. (1 screw)
- 3) Remove the metal plate electrical wiring cover. (4 tabs)
- 4) Attach the connection cord to the S21 connector and pull the harness out through the notched part in the figure.
- 5) Replace the electrical wiring cover as it was, and pull the harness around, as shown in the figure.

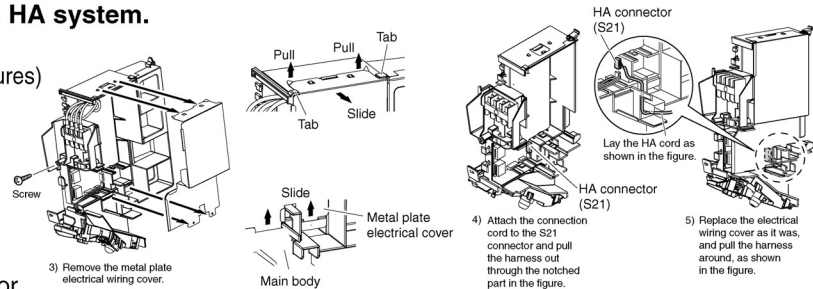

### 6. Drain piping.

- 1) Connect the drain hose, as described below.

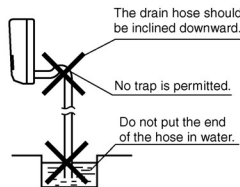

- 2) Remove the air filters and pour some water into the drain pan to check the water flows smoothly.

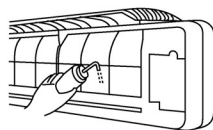

- 3) When drain hose requires extension, obtain an extension hose commercially available. Be sure to thermally insulate the indoor section of the extension hose.

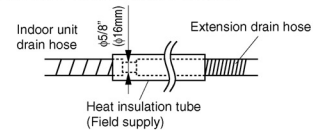

- 4) When connecting a rigid polyvinyl chloride pipe (nominal diameter 1/2 inch (13mm)) directly to the drain hose attached to the indoor unit as with embedded piping work, use any commercially available drain hose socket (nominal diameter 1/2 inch (13mm)) as a joint.

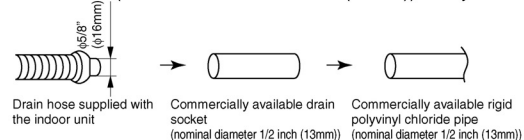



## Refrigerant Piping Work

### 1. Flaring the pipe end.

- 1) Cut the pipe end with a pipe cutter.
- 2) Remove burrs with the cut surface facing downward so that the chips do not enter the pipe.
- 3) Put the flare nut on the pipe.
- 4) Flare the pipe.
- 5) Check that the flaring is properly made.

(Cut exactly at right angles.) Remove burrs

Flaring

| Set exactly at the position shown below. |                        | Flaring                      |                               |  |
|--|------------------------|------------------------------|-------------------------------|--|
| A  | Flare tool for R410A   |                              | Conventional flare tool       |  |
|  | Clutch-type            | Clutch-type (Rigid-type)     | Wing-nut type (Imperial-type) |  |
| A  | 0-0.020 inch (0-0.5mm) | 0.039-0.059 inch (1.0-1.5mm) | 0.059-0.079 inch (1.5-2.0mm)  |  |

**Check**

Flare's inner surface must be flaw-free.

The pipe end must be evenly flared in a perfect circle.

Make sure that the flare nut is fitted.

**⚠ WARNING**

- 1) Do not use mineral oil on flared part.
- 2) Prevent mineral oil from getting into the system as this would reduce the lifetime of the units.
- 3) Never use piping which has been used for previous installations. Only use parts which are delivered with the unit.
- 4) Never install a drier to this R410A unit in order to guarantee its lifetime.
- 5) The drying material may dissolve and damage the system.
- 6) Incomplete flaring may cause refrigerant gas leakage.

### 2. Refrigerant piping.

**⚠ CAUTION**

- 1) Use the flare nut fixed to the main unit. (To prevent cracking of the flare nut by aged deterioration.)
- 2) To prevent gas leakage, apply refrigeration oil only to the inner surface of the flare. (Use refrigeration oil for R410A.)
- 3) Use torque wrenches when tightening the flare nuts to prevent damage to the flare nuts and gas leakage.

Align the centers of both flares and tighten the flare nuts 3 or 4 turns by hand. Then tighten them fully with the torque wrenches.

**[Apply oil]**

**[Tighten]**

| Flare nut tightening torque           |                                       |
|---------------------------------------|---------------------------------------|
| Gas side                              | Liquid side                           |
| 5/8 inch (15.9mm)                     | 3/8 inch (9.5mm)                      |
| 45.6-55.6ft · lbf<br>(61.8-75.4N · m) | 24.1-29.4ft · lbf<br>(32.7-39.9N · m) |

#### 2-1. Caution on piping handling.

- 1) Protect the open end of the pipe against dust and moisture.
- 2) All pipe bends should be as gentle as possible. Use a pipe bender for bending.

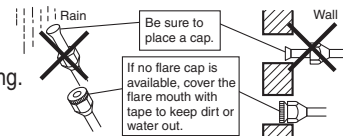

#### 2-2. Selection of copper and heat insulation materials.

- When using commercial copper pipes and fittings, observe the following:
  - 1) Insulation material: Polyethylene foam  
Heat transfer rate: 0.041 to 0.052W/mK (0.024-0.030Btu/ft<sup>2</sup>h°F (0.035-0.045kcal/mh°C))  
Be sure to use insulation that is designed for use with HVAC Systems.
  - 2) Be sure to insulate both the gas and liquid piping and to provide insulation dimensions as below.

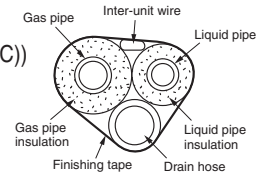

| Gas side                              | Liquid side                             | Gas pipe thermal insulation      | Liquid pipe thermal insulation  |
|---------------------------------------|---|----------------------------------|---------------------------------|
| O.D. 5/8 inch (15.9mm)                | O.D. 3/8inch (9.5mm)                    | I.D. 0.630-0.787 inch (16-20mm)  | I.D. 0.472-0.591 inch (12-15mm) |
| Minimum bend radius                   |   | Thickness 0.393 inch (10mm) Min. |                                 |
| 1-15/16 inch (50mm) or more           | 1-3/16 inch (30mm) or more              |                                  |                                 |
| Thickness 0.039 inch (1mm) (C1220T-O) | Thickness 0.031 inch (0.8mm) (C1220T-O) |                                  |                                 |

- 3) Use separate thermal insulation pipes for gas and liquid refrigerant pipes.

## Pump Down Operation

**In order to protect the environment, be sure to pump down when relocating or disposing of the unit.**

- 1) Remove the valve cap from liquid stop valve and gas stop valve.
- 2) Carry out forced cooling operation.
- 3) After 5 to 10 minutes, close the liquid stop valve with a hexagonal wrench.
- 4) After 2 to 3 minutes, close the gas stop valve and stop forced cooling operation.

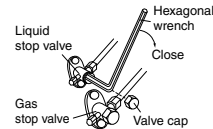

### How to force cooling operation mode

#### ■Using the indoor unit ON/OFF switch

Press the indoor unit ON/OFF switch for at least 5 seconds. (Operation will start.)

- Forced cooling operation will stop automatically after around 15 minutes.

To stop force cooling operation, press the indoor unit ON/OFF switch.

#### ■Using the main unit's remote controller

- 1) Press the MODE button and select the cooling mode.
- 2) Press the ON/OFF button to turn on the system.
- 3) Press the both of TEMP button and the MODE button at the same time.
- 4) Press the MODE button twice. (77 will be displayed and the unit will enter test run mode.)
  - Test run mode will stop automatically after around 30 minutes. To stop test run mode, press the ON/OFF button.

### ⚠ CAUTION

- 1) After closing the liquid stop valve, close the gas stop valve within 3 minutes, then stop the forced operation.

## Trial Operation and Testing (1)

### 1. Trial operation and testing.

1-1 Measure the supply voltage and make sure that it falls in the specified range.

1-2 Trial operation should be carried out in either cooling or heating mode.

#### ■For Heat pump

- 1) In cooling mode, select the lowest programmable temperature; in heating mode, select the highest programmable temperature.  
Trial operation may be disabled in either mode depending on the room temperature.  
In that case, use the remote controller for trial operation as described below.
- 2) After trial operation is complete, set the temperature to a normal level (78°F to 82°F (26°C to 28°C) in cooling mode, 68°F to 75°F (20°C to 24°C) in heating mode).
  - For protection, the system disables restart operation for 3 minutes after it is turned off.

#### ■For Cooling only

- Select the lowest programmable temperature.
  - 1) Trial operation in cooling mode may be disabled depending on the room temperature.  
Use the remote controller for trial operation as described below.
  - 2) After trial operation is complete, set the temperature to a normal level (78°F to 82°F (26°C to 28°C)).
  - 3) For protection, the system disables restart operation for 3 minutes after it is turned off.

1-3 Carry out the test operation in accordance with the operation manual to ensure that all functions and parts, such as louver movement, are working properly.

- The air conditioner requires a small amount of power in its standby mode. If the system is not to be used for some time after installation, shut off the circuit breaker to eliminate unnecessary power consumption.
- If the circuit breaker trips to shut off the power to the air conditioner, the system will restore the original operation mode when the circuit breaker is opened again.

## Trial Operation and Testing (2)

### Trial operation from remote controller.

- 1) Press the MODE button and select the trial operation mode. (cooling and heating).
- 2) Press the ON/OFF button to turn on the system.
- 3) Press the both of TEMP button and the MODE button at the same time.
- 4) Press the MODE button twice. (7° will be displayed and the unit will enter test run mode.)
  - Test run mode will stop automatically after around 30 minutes. To stop test run mode, press the ON/OFF button.

### 2. Test items.

| Test items   | Symptom<br>(diagnostic display on RC) | Check |
|--|---------------------------------------|-------|
| Indoor and outdoor units are installed properly on solid bases.                                | Fall, vibration, noise                |       |
| No refrigerant gas leaks.  | Incomplete cooling/heating function   |       |
| Refrigerant gas and liquid pipes and indoor drain hose extension are thermally insulated.      | Water leakage                         |       |
| Draining line is properly installed.   | Water leakage                         |       |
| System is properly ground to earth.  | Electrical leakage                    |       |
| The specified wires are used for inter-unit wiring.  | Inoperative or burn damage            |       |
| Indoor or outdoor unit's air intake or exhaust has clear path of air. Stop valves are opened.  | Incomplete cooling/heating function   |       |
| Indoor unit properly receives remote controller commands.                                      | Inoperative                           |       |
| The heat pump or cooling only mode is selectable with the DIP switch of the remote controller. | Remote controller malfunctioning      |       |

## 11.2 Outdoor Unit





### Safety Considerations

Read these **SAFETY CONSIDERATIONS for Installation** carefully before installing an air conditioner or heat pump. After completing the installation, make sure that the unit operates properly during the startup operation.

Instruct the customer on how to operate and maintain the unit. Inform customers that they should store this Installation Manual with the Operation Manual for future reference.

Always use a licensed installer or contractor to install this product. Improper installation can result in water or refrigerant leakage, electrical shock, fire, or explosion.

Meanings of **DANGER**, **WARNING**, **CAUTION**, and **NOTE** Symbols:

-  **DANGER** ..... Indicates an imminently hazardous situation which, if not avoided, will result in death or serious injury.
-  **WARNING** ..... Indicates a potentially hazardous situation which, if not avoided, could result in death or serious injury.
-  **CAUTION** ..... Indicates a potentially hazardous situation which, if not avoided, may result in minor or moderate injury. It may also be used to alert against unsafe practices.
-  **NOTE** ..... Indicates situations that may result in equipment or property-damage accidents only.

- **Refrigerant gas is heavier than air and replaces oxygen. A massive leak can lead to oxygen depletion, especially in basements, and an asphyxiation hazard could occur leading to serious injury or death.**
- **Do not ground units to water pipes, gas pipes, telephone wires, or lightning rods as incomplete grounding can cause a severe shock hazard resulting in severe injury or death. Additionally, grounding to gas pipes could cause a gas leak and potential explosion causing severe injury or death.**
- **If refrigerant gas leaks during installation, ventilate the area immediately. Refrigerant gas may produce toxic gas if it comes into contact with fire. Exposure to this gas could cause severe injury or death.**
- **After completing the installation work, check that the refrigerant gas does not leak throughout the system.**
- **Do not install unit in an area where flammable materials are present due to risk of explosions that can cause serious injury or death.**
- **Safely dispose all packing and transportation materials in accordance with federal/state/local laws or ordinances. Packing materials such as nails and other metal or wood parts, including plastic packing materials used for transportation may cause injuries or death by suffocation.**
- **Only qualified personnel must carry out the installation work. Installation must be done in accordance with this installation manual. Improper installation may result in water leakage, electric shock, or fire.**
- **When installing the unit in a small room, take measures to keep the refrigerant concentration from exceeding allowable safety limits. Excessive refrigerant leaks, in the event of an accident in a closed ambient space, can lead to oxygen deficiency.**
- **Use only specified accessories and parts for installation work. Failure to use specified parts may result in water leakage, electric shocks, fire, or the unit falling.**
- **Install the air conditioner or heat pump on a foundation strong enough that it can withstand the weight of the unit. A foundation of insufficient strength may result in the unit falling and causing injuries.**
- **Take into account strong winds, typhoons, or earthquakes when installing. Improper installation may result in the unit falling and causing accidents.**
- **Make sure that a separate power supply circuit is provided for this unit and that all electrical work is carried out by qualified personnel according to local, state, and national regulations. An insufficient power supply capacity or improper electrical construction may lead to electric shocks or fire.**
- **Make sure that all wiring is secured, that specified wires are used, and that no external forces act on the terminal connections or wires. Improper connections or installation may result in fire.**
- **When wiring, position the wires so that the terminal box lid can be securely fastened. Improper positioning of the terminal box lid may result in electric shocks, fire, or the terminals overheating.**
- **Before touching electrical parts, turn off the unit.**
- **Securely fasten the outside unit terminal cover (panel). If the terminal cover/panel is not installed properly, dust or water may enter the outside unit causing fire or electric shock.**
- **When installing or relocating the system, keep the refrigerant circuit free from substances other than the specified refrigerant (R-410A) such as air. Any presence of air or other foreign substance in the refrigerant circuit can cause an abnormal pressure rise or rupture, resulting in injury.**
- **Do not change the setting of the protection devices. If the pressure switch, thermal switch, or other protection device is shorted and operated forcibly, or parts other than those specified by Daikin are used, fire or explosion may occur.**
- **Do not touch the switch with wet fingers. Touching a switch with wet fingers can cause electric shock.**

- Do not allow children to play on or around the unit to prevent injury.
- The heat exchanger fins are sharp enough to cut. To avoid injury wear gloves or cover the fins while working around them.
- Do not touch the refrigerant pipes during and immediately after operation as the refrigerant pipes may be hot or cold, depending on the condition of the refrigerant flowing through the refrigerant piping, compressor, and other refrigerant cycle parts. Your hands may suffer burns or frostbite if you touch the refrigerant pipes. To avoid injury, give the pipes time to return to normal temperature or, if you must touch them, be sure to wear proper gloves.
- Install drain piping to proper drainage. Improper drain piping may result in water leakage and property damage.
- Insulate piping to prevent condensation.
- Be careful when transporting the product.
- Do not turn off the power immediately after stopping operation. Always wait for at least 5 minutes before turning off the power. Otherwise, water leakage may occur.
- Do not use a charging cylinder. Using a charging cylinder may cause the refrigerant to deteriorate.
- Refrigerant R-410A in the system must be kept clean, dry, and tight.
  - (a) Clean and Dry -- Foreign materials (including mineral oils such as SUNISO oil or moisture) should be prevented from getting into the system.
  - (b) Tight -- R-410A does not contain any chlorine, does not destroy the ozone layer, and does not reduce the earth's protection against harmful ultraviolet radiation. R-410A can contribute to the greenhouse effect if it is released. Therefore take proper measures to check for the tightness of the refrigerant piping installation. Read the chapter *Refrigerant Piping* and follow the procedures.
- Since R-410A is a blend, the required additional refrigerant must be charged in its liquid state. If the refrigerant is charged in a state of gas, its composition can change and the system will not work properly.
- The indoor unit is for R-410A. See the catalog for indoor models that can be connected. Normal operation is not possible when connected to other units.
- Remote controller (wireless kit) transmitting distance can be shorter than expected in rooms with electronic fluorescent lamps (inverter or rapid start types). Install the indoor unit far away from fluorescent lamps as much as possible.
- Indoor units are for indoor installation only. Outdoor units can be installed either outdoors or indoors. This unit is for indoor use.
- Do not install the air conditioner or heat pump in the following locations:
  - (a) Where a mineral oil mist or oil spray or vapor is produced, for example, in a kitchen. Plastic parts may deteriorate and fall off or result in water leakage.
  - (b) Where corrosive gas, such as sulfurous acid gas, is produced. Corroding copper pipes or soldered parts may result in refrigerant leakage.
  - (c) Near machinery emitting electromagnetic waves. Electromagnetic waves may disturb the operation of the control system and cause the unit to malfunction.
  - (d) Where flammable gas may leak, where there is carbon fiber, or ignitable dust suspension in the air, or where volatile flammables such as thinner or gasoline are handled. Operating the unit in such conditions can cause a fire.
- Take adequate measures to prevent the outside unit from being used as a shelter by small animals. Small animals making contact with electrical parts can cause malfunctions, smoke, or fire. Instruct the customer to keep the area around the unit clean.
- Install the power supply and control wires for the indoor and outdoor units at least 3.5 feet away from televisions or radios to prevent image interference or noise. Depending on the radio waves, a distance of 3.5 feet may not be sufficient to eliminate the noise.
- Dismantling the unit, treatment of the refrigerant, oil and additional parts must be done in accordance with the relevant local, state, and national regulations.
- Do not use the following tools that are used with conventional refrigerants: gauge manifold, charge hose, gas leak detector, reverse flow check valve, refrigerant charge base, vacuum gauge, or refrigerant recovery equipment.
- If the conventional refrigerant and refrigerator oil are mixed in R-410A, the refrigerant may deteriorate.
- This air conditioner or heat pump is an appliance that should not be accessible to the general public.
- As design pressure is 478 psi, the wall thickness of field-installed pipes should be selected in accordance with the relevant local, state, and national regulations.

## Precautions for Selecting the Location

- 1) Choose a place solid enough to bear the weight and vibration of the unit, where the operation sounds will not be amplified.
- 2) Choose a location where the hot air discharged from the unit or the operation sounds will not disturb the neighbors of the user.
- 3) Avoid installing near bedrooms so that operation sounds will not be a problem.
- 4) There must be sufficient spaces for carrying the unit into and out of the site.
- 5) There must be sufficient space for air passage and no obstructions around the air inlet and the air outlet.
- 6) The site must be free from the possibility of flammable gas leakage in a nearby place.
- 7) Install units, power cords and inter-unit wire at least 10ft (3m) away from television and radio sets. This is to prevent interference to images and sounds. (Noises may be heard even if they are more than 10ft (3m) away depending on radio wave conditions.)
- 8) In coastal areas or other places with salty atmosphere of sulfate gas, corrosion may shorten the life of the air conditioner.
- 9) Since drain flows out of the outdoor unit, do not place anything under the unit which must be kept away from moisture.

### NOTE

Cannot be installed hanging from ceiling or stacked.

### CAUTION

When operating the air conditioner in a low outdoor ambient temperature, be sure to follow the instructions described below.

- To prevent exposure to wind, install the outdoor unit with its suction side facing the wall.
- Never install the outdoor unit at a site where the suction side may be exposed directly to wind.
- To prevent exposure to wind, it is recommended to install a baffle plate on the air discharge side of the outdoor unit.
- In heavy snowfall areas, select an installation site where the snow will not affect the unit.



- Construct a large canopy.
- Construct a pedestal.

Install the unit high enough off the ground to prevent burying in snow.

## Precautions on Installation

- Check the strength and level of the installation ground so that the unit will not cause any operating vibration or noise after installed.
- In accordance with the foundation drawing, fix the unit securely by means of the foundation bolts.  
(Prepare 4 sets of 1/2 inch (M12) foundation bolts, nuts and washers each which are available on the market.)
- It is best to screw in the foundation bolts until their ends are 3/4 inch (20mm) from the foundation surface.

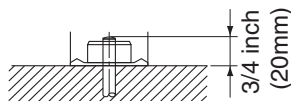

# Outdoor Unit Installation Drawings

|  |                        |
|--|------------------------|
| Max. allowable piping length   | 98.4ft (30m)           |
| Min. allowable piping length   | 6.56ft (2m)            |
| Max. allowable piping height   | 65.6ft (20m)           |
| Additional refrigerant required for refrigerant pipe exceeding 32.8ft (10m) in length. | 0.54oz/ft (50g/m)      |
| Gas pipe   | O.D. 5/8 inch (15.9mm) |
| Liquid pipe  | O.D. 3/8 inch (9.5mm)  |

\* Be sure to add the proper amount of additional refrigerant. Failure to do so may result in reduced performance.  
 \*\* The suggested shortest pipe length is 6.56ft (2m), in order to avoid noise from the outdoor unit and vibration. (Mechanical noise and vibration may occur depending on how the unit is installed and the environment in which it is used.)

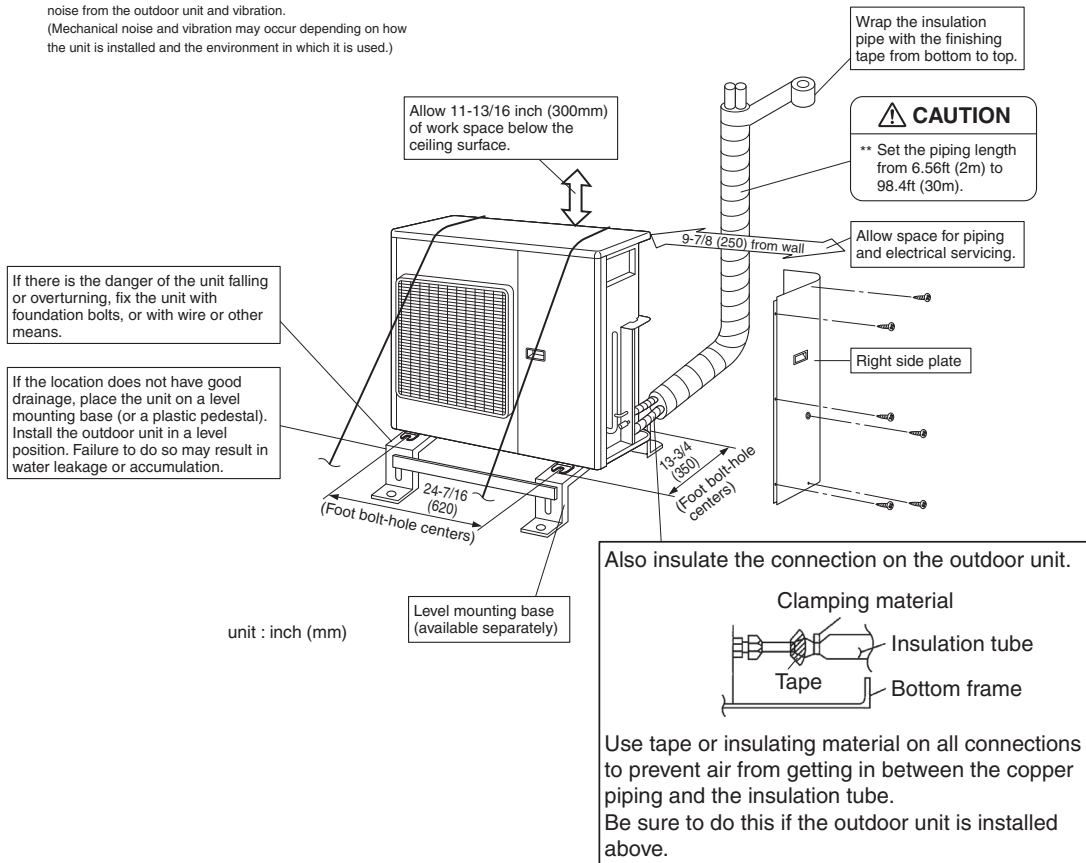

# Installation Guidelines

- Where a wall or other obstacle is in the path of outdoor unit's inlet or outlet airflow, follow the installation guidelines below.
- For any of the below installation patterns, the wall height on the outlet side should be 47-1/4 inch (1200mm) or less.

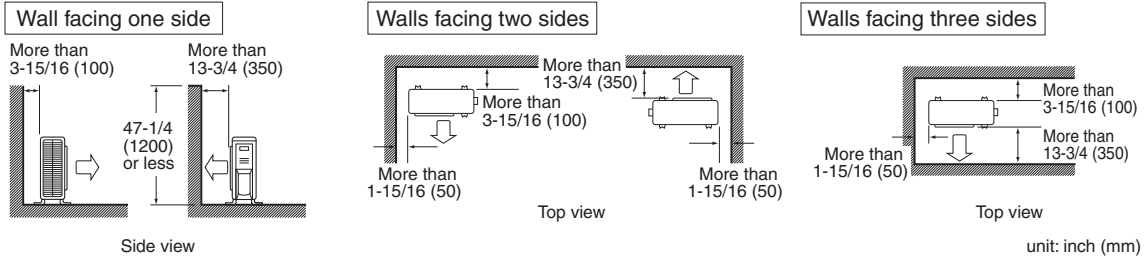

# Outdoor Unit Installation

## 1. Installing outdoor unit

- 1) When installing the outdoor unit, refer to "Precautions for Selecting the Location" and the "Outdoor Unit Installation Drawings".
- 2) If drain work is necessary, follow the procedures below.

## 2. Drain work

- Use drain plug for drainage.
- If the drain port is covered by a mounting base or floor surface, place additional foot bases of at least 3-15/16 inch (100mm) in height under the outdoor unit's feet.
- In cold areas, do not use a drain socket (A), drain caps (B) and a drain hose with the outdoor unit. (Otherwise, drain water may freeze, impairing heating performance.)

- 1) Insert drain receiver (C) onto drain socket (A) and drain cap (B) beyond 4 projections around drain socket and drain cap.
- 2) Insert drain socket and drain caps into their matching drain hole; Drain socket (A) into drain hole I and drain caps (B) into the other drain holes. After insertion, turn them about 40° clockwise.

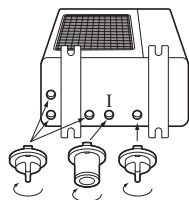

(Be sure not to insert them into wrong drain holes, or there causes water leakage.)

(View from bottom)

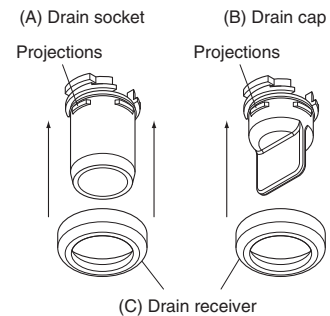

**NOTE**

Check that the drain receiver (C) is correctly engaged with the projections of the drain socket (A) and drain cap (B). Otherwise, water leakage may result.

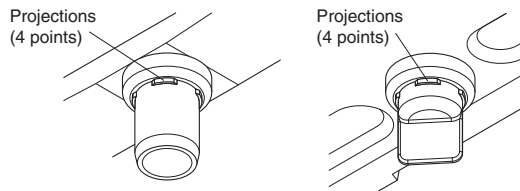

- 3) Connect vinyl hose on the market (internal diameter of 1 inch (25mm)) to drain socket (A). (If the hose is too long and hangs down, fix it carefully to prevent the kinks.)
- 4) Make sure that there is no water leakage from portion I, II, or III.

**NOTE**

If the drain holes of the outdoor unit are covered with the mounting bracket or the floor, raise the unit to provide the space of more than 3-15/16 inch (100mm) under the leg of the outdoor unit.



# Outdoor Unit Installation

## 3. Flaring the pipe end

- 1) Cut the pipe end with a pipe cutter.
- 2) Remove burrs with the cut surface facing downward so that the chips do not enter the pipe.
- 3) Put the flare nut on the pipe.
- 4) Flare the pipe.
- 5) Check that the flaring is properly made.

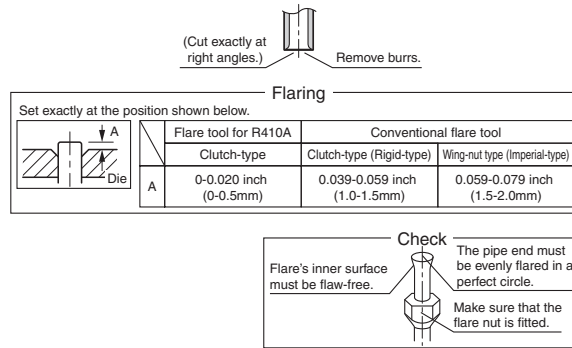

### ⚠ WARNING

- Do not use mineral oil on flared part.
- Prevent mineral oil from getting into the system as this would reduce the lifetime of the units.
- Never use piping which has been used for previous installations. Only use parts which are delivered with the unit.
- Never install a drier to this R410A unit in order to guarantee its lifetime.
- The drying material may dissolve and damage the system.
- Incomplete flaring may cause refrigerant gas leakage.

## 4. Refrigerant piping

### ⚠ CAUTION

- Use the flare nut fixed to the main unit to prevent it from cracking and deteriorating from age.
- To prevent gas leakage, apply refrigeration oil only to the inner surface of the flare. (Use refrigeration oil for R410A.)
- Use torque wrenches when tightening the flare nuts to prevent damage to the flare nuts and gas leakage.

- Align the centers of both flares and tighten the flare nuts 3 or 4 turns by hand. Then tighten them fully with the torque wrenches.

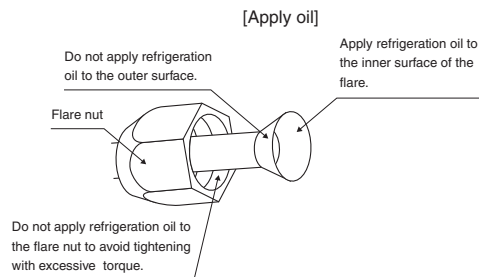

| Flare nut tightening torque           |                                       |
|---------------------------------------|---------------------------------------|
| Gas side                              | Liquid side                           |
| 5/8 inch (15.9mm)                     | 3/8 inch (9.5mm)                      |
| 45.6-55.6ft • lbf<br>(61.8-75.4N • m) | 24.1-29.4ft • lbf<br>(32.7-39.9N • m) |

| Valve cap tightening torque           |                                       |
|---------------------------------------|---------------------------------------|
| Gas side                              | Liquid side                           |
| 5/8 inch (15.9mm)                     | 3/8 inch (9.5mm)                      |
| 35.5-44.0ft • lbf<br>(48.1-59.7N • m) | 15.9-20.2ft • lbf<br>(21.6-27.4N • m) |

| Service port cap tightening torque   |
|--------------------------------------|
| 7.9-10.8ft • lbf<br>(10.8-14.7N • m) |

## 5. Purging air and checking gas leakage

### ⚠ WARNING

- Do not mix any substance other than the specified refrigerant (R410A) into the refrigeration cycle.
- When refrigerant gas leaks occur, ventilate the room as soon and as much as possible.
- R410A, as well as other refrigerants, should always be recovered and never be released directly into the environment.
- Use a vacuum pump for R410A exclusively. Using the same vacuum pump for different refrigerants may damage the vacuum pump or the unit.

- When piping work is completed, it is necessary to purge the air and check for gas leakage.
- If using additional refrigerant, perform air purging from the refrigerant pipes and indoor unit using a vacuum pump, then charge additional refrigerant.
- Use a hexagonal wrench (3/16 inch (4mm)) to operate the stop valve.
- All refrigerant pipe joints should be tightened with a torque wrench at the specified tightening torque.

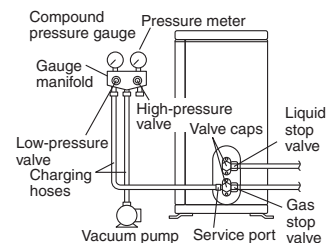

1) Connect projection side of charging hose (which comes from gauge manifold) to gas stop valve's service port.



2) Fully open gauge manifold's low-pressure valve (Lo) and completely close its high-pressure valve (Hi). (High-pressure valve subsequently requires no operation.)



3) Do vacuum pumping and make sure that the compound pressure gauge reads  $-29.9\text{inHg}$  ( $-0.1\text{MPa}$ ).<sup>\*1</sup>



4) Close gauge manifold's low-pressure valve (Lo) and stop vacuum pump. (Keep this state for a few minutes to make sure that the compound pressure gauge pointer does not swing back.)<sup>\*2</sup>



5) Remove caps from liquid stop valve and gas stop valve.



6) Turn the liquid stop valve's rod 90 degrees counterclockwise with a hexagonal wrench to open valve. Close it after 5 seconds, and check for gas leakage. Using soapy water, check for gas leakage from indoor unit's flare and outdoor unit's flare and valve rods. After the check is complete, wipe all soapy water off.



7) Disconnect charging hose from gas stop valve's service port, then fully open liquid and gas stop valves. (Do not attempt to turn valve rod beyond its stop.)



8) Tighten valve caps and service port caps for the liquid and gas stop valves with a torque wrench at the specified torques.

<sup>\*1</sup> Pipe length vs. vacuum pump run time

|             |                       |                        |
|-------------|-----------------------|------------------------|
| Pipe length | Up to 49.2ft (15m)    | More than 49.2ft (15m) |
| Run time    | Not less than 10 min. | Not less than 15 min   |

<sup>\*2</sup> If the compound pressure gauge pointer swings back, refrigerant may have water content or a loose pipe joint may exist. Check all pipe joints and retighten nuts as needed, then repeat steps 2) through 4).

# Outdoor Unit Installation

## 6. Refilling the refrigerant

Check the type of refrigerant to be used on the machine nameplate.

### Precautions when adding R410A

#### Fill from the gas pipe in liquid form.

It is a mixed refrigerant, so adding it in gas form may cause the refrigerant composition to change, preventing normal operation.

- 1) Before filling, check whether the cylinder has a siphon attached or not. (It should have something like “liquid filling siphon attached” displayed on it.)

Filling a cylinder with an attached siphon

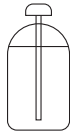

Stand the cylinder upright when filling.

(There is a siphon pipe inside, so the cylinder need not be upside-down to fill with liquid.)

Filling other cylinders



Turn the cylinder upside-down when filling.

- Be sure to use the R410A tools to ensure pressure and to prevent foreign objects entering.

## 7. Refrigerant piping work

### 7-1 Caution on pipe handling

- 1) Protect the open end of the pipe against dust and moisture.
- 2) All pipe bends should be as gentle as possible. Use a pipe bender for bending.

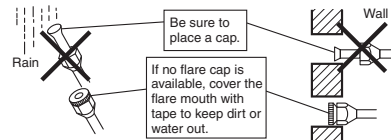

### 7-2 Selection of copper and heat insulation materials

When using commercial copper pipes and fittings, observe the following:

- 1) Insulation material: Polyethylene foam  
Heat transfer rate: 0.041 to 0.052W/mK (0.024 to 0.030Btu/fth°F (0.035 to 0.045kcal/mh°C))  
Be sure to use insulation that is designed for use with HVAC Systems.
- 2) Be sure to insulate both the gas and liquid piping and to provide insulation dimensions as below.

| Gas side                                | Liquid side                             | Gas pipe thermal insulation      | Liquid pipe thermal insulation  |
|---|---|----------------------------------|---------------------------------|
| O.D. 5/8 inch (15.9mm)                  | O.D. 3/8 inch (9.5mm)                   | I.D. 5/8-25/32 inch (16-20mm)    | I.D. 15/32-19/32 inch (12-15mm) |
| Minimum bend radius                     |   | Thickness 13/32 inch (10mm) Min. |                                 |
| 1-15/16 inch (50mm) or more             | 1-3/16 inch (30mm) or more              |                                  |                                 |
| Thickness 0.039 inch (1.0mm) (C1220T-O) | Thickness 0.031 inch (0.8mm) (C1220T-O) |                                  |                                 |

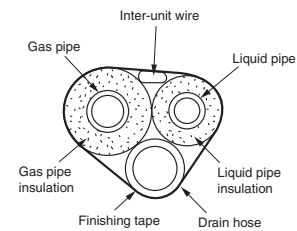

- Use separate thermal insulation pipes for gas and liquid refrigerant pipes.

# Pump Down Operation

In order to protect the environment, be sure to pump down when relocating or disposing of the unit.

- 1) Remove the valve cap from liquid stop valve and gas stop valve.
- 2) Carry out forced cooling operation.
- 3) After 5 to 10 minutes, close the liquid stop valve with a hexagonal wrench.
- 4) After 2 to 3 minutes, close the gas stop valve and stop forced cooling operation.

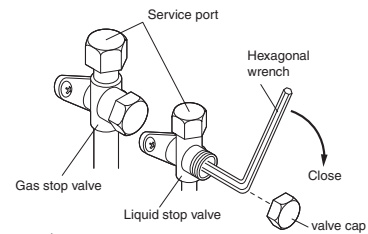

## Forced cooling operation

### ■ Using the indoor unit ON/OFF switch

Press the indoor unit ON/OFF switch for at least 5 seconds. (The operation will start.)

- Forced cooling operation will stop automatically after around 15 minutes.
- To stop the operation, press the indoor unit ON/OFF switch.

### ■ Using the indoor unit's remote controller

- 1) Press "MODE" button and select the cooling mode.
  - 2) Press "ON/OFF" button to turn on the system.
  - 3) Press both of "TEMP" button and "MODE" button at the same time.
  - 4) Press "MODE" button twice. (  $\overline{\text{7}}$  will be displayed and the unit will enter forced cooling operation.)
- Forced cooling operation will stop automatically after around 30 minutes.
  - To stop the operation, press "ON/OFF" button.

### ■ Using the outdoor unit forced cooling operation switch

Forced cooling operation can be performed when the outdoor unit forced cooling operation switch is pressed within around 3 minutes after power is supplied.

Press the switch (SW1). (The operation will start.)

- Forced cooling operation will stop automatically after around 15 minutes.
- To stop the operation, press the switch (SW1).

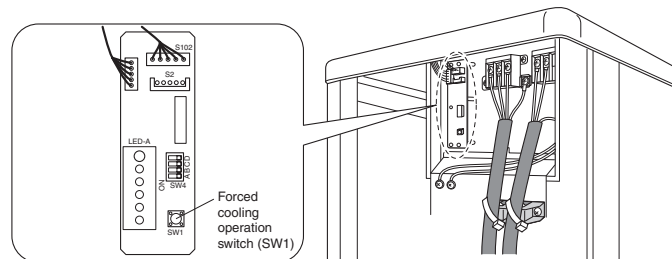

# Wiring

## ⚠ WARNING

- Do not use tapped wires, stranded wires, extension cords, or starburst connections, as they may cause overheating, electrical shock, or fire.
- Do not use locally purchased electrical parts inside the product. (Do not branch the power for the drain pump, etc., from the terminal block.) Doing so may cause electric shock or fire.
- Be sure to install a ground fault circuit interrupter breaker. (One that can handle higher harmonics.) (This unit uses an inverter, which means that it must be used a ground fault circuit interrupter breaker capable handling harmonics in order to prevent malfunctioning of the ground fault circuit interrupter breaker itself.)
- Use an all-pole disconnection type breaker with at least 1/8 inch (3mm) between the contact point gaps.
- When carrying out wiring connection, take care not to pull at the conduit.
- Do not connect the power wire to the indoor unit. Doing so may cause electric shock or fire.

- Do not turn on the safety breaker until all work is completed.

- 1) Strip the insulation from the wire (3/4inch (20mm)).
- 2) Connect the connection wires between the indoor and outdoor units so that the terminal numbers match. Tighten the terminal screws securely. We recommend a flathead screwdriver be used to tighten the screws.

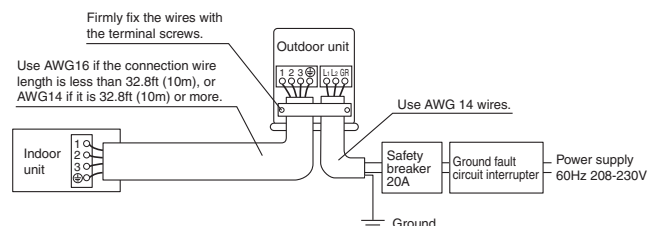

NOTE: This equipment can be installed with a Ground-Fault Circuit Breaker (GFCI). Although this is a recognized measure for additional protection, with the earthing system in North America, a dedicated GFCI is not necessary.

# Wiring (1)

<Method of mounting conduit>

Pass wires through the conduit and secure them with a lock nut.

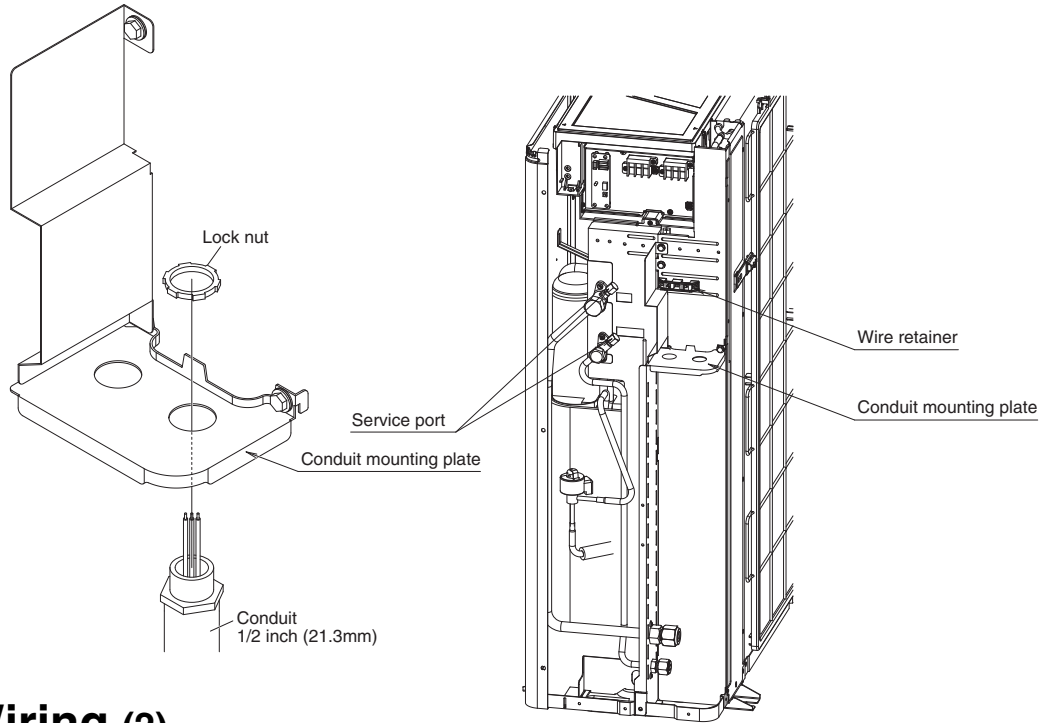

# Wiring (2)

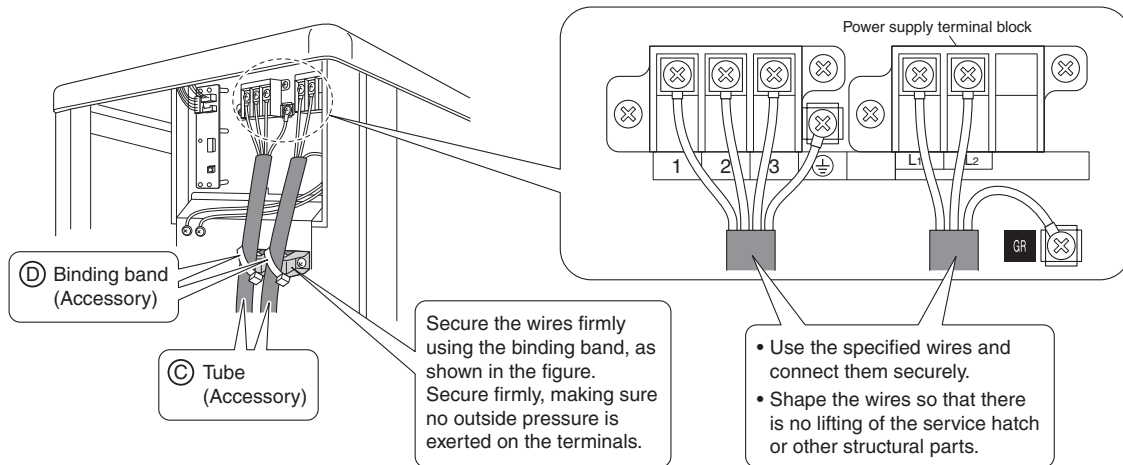

Observe the notes mentioned following when wiring to the power supply terminal block.  
Precautions to be taken for power supply wiring.

**⚠ CAUTION**

- When connecting the connection wires to the terminal block using a single core wire, be sure to perform curling. Problems with the work may cause heat and fires.

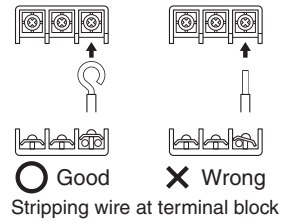

- If the stranded wires must be used, make sure to use the round crimp-style terminal for connection to the power supply terminal block. Place the round crimp-style terminals on the wires up to the covered part and secure in place.

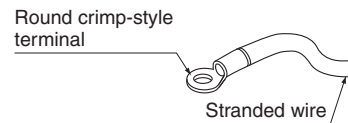

- Ground terminal installation  
Use the following method when installing the round crimp-style terminal.

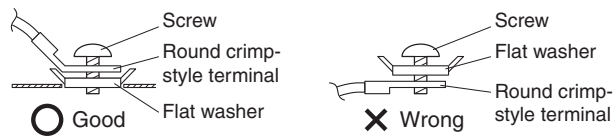

3) Pull the wire and make sure that it does not disconnect. Then fix the wire in place with a wire stop.

## Facility Setting (cooling at low outdoor temperature)

This function is designed for facilities such as equipment or computer rooms. It is never to be used in a residence or office where people occupy the space.

- 1) You can expand the operation range to 14°F (-10°C) by turning on switch B (SW4) on the PCB. If the outdoor temperature falls to -0.4°F (-18°C) or lower, the operation will stop. If the outdoor temperature rises, the operation will start again.

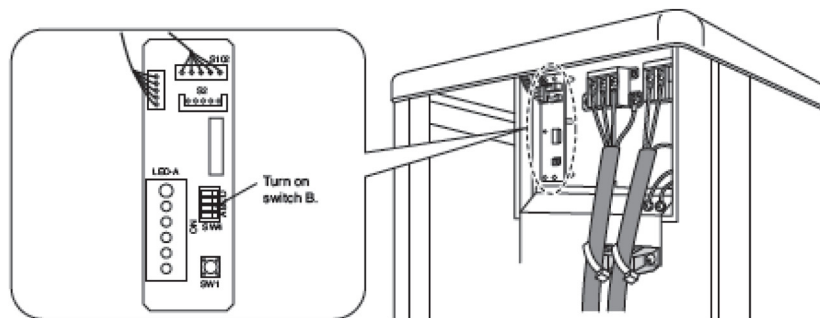

**⚠ CAUTION**

- If the outdoor unit is installed where the heat exchanger of the unit is exposed to direct wind, provide a windbreak wall.
- Intermittent noises may be produced by the indoor unit due to the outdoor fan turning on and off when using facility settings.
- Do not place humidifiers or other items which might raise the humidity in rooms where facility settings are being used. A humidifier might cause dew condensation from the indoor unit outlet vent.
- Use the indoor unit at the highest level of airflow rate.

# Trial Operation and Testing

## 1. Trial operation and testing

1-1 Measure the supply voltage and make sure that it falls in the specified range.

1-2 Trial operation should be carried out in either cooling or heating mode.

■ For heat pump

- In cooling mode, select the lowest programmable temperature; in heating mode, select the highest programmable temperature.

- 1) Trial operation may be disabled in either mode depending on the room temperature.
- 2) After trial operation is complete, set the temperature to a normal level (78°F to 82°F (26°C to 28°C) in cooling mode, 68°F to 75°F (20°C to 24°C) in heating mode).
- 3) For protection, the system disables restart operation for 3 minutes after it is turned off.

■ For cooling only

- Select the lowest programmable temperature.

- 1) Trial operation in cooling mode may be disabled depending on the room temperature.
- 2) After trial operation is complete, set the temperature to a normal level (78°F to 82°F (26°C to 28°C)).
- 3) For protection, the system disables restart operation for 3 minutes after it is turned off.

1-3 Carry out the test operation in accordance with the operation manual to ensure that all functions and parts, such as fin movement, are working properly.

- The air conditioner requires a small amount of power in its standby mode. If the system is not to be used for some time after installation, shut off the circuit breaker to eliminate unnecessary power consumption.
- If the circuit breaker trips to shut off the power to the air conditioner, the system will restore the original operation mode when the circuit breaker is opened again.

## 2. Test items

| Test items  | Symptom                             | Check |
|---|-------------------------------------|-------|
| Indoor and outdoor units are installed properly on solid bases.                                 | Fall, vibration, noise              |       |
| No refrigerant gas leaks.   | Incomplete cooling/heating function |       |
| Refrigerant gas and liquid pipes and indoor drain hose extension are thermally insulated.       | Water leakage                       |       |
| Draining line is properly installed.  | Water leakage                       |       |
| System is properly grounded.  | Electrical leakage                  |       |
| The specified wires are used for inter-unit wiring.   | Inoperative or burn damage          |       |
| Indoor or outdoor unit's air inlet or air outlet has clear path of air. Stop valves are opened. | Incomplete cooling/heating function |       |
| Indoor unit properly receives remote control commands.  | Inoperative                         |       |





## 12. Operation Manual

### Safety Considerations

Read these **SAFETY CONSIDERATIONS for Operations** carefully before operating an air conditioner or heat pump. Make sure that the unit operates properly during the startup operation. Instruct the customer on how to operate and maintain the unit.

Inform customers that they should store this Operation Manual with the Installation Manual for future reference.

Meanings of **DANGER**, **WARNING**, **CAUTION**, and **NOTE** Symbols:

-  **DANGER** .....Indicates an imminently hazardous situation which, if not avoided, will result in death or serious injury.
-  **WARNING** .....Indicates a potentially hazardous situation which, if not avoided, could result in death or serious injury.
-  **CAUTION** .....Indicates a potentially hazardous situation which, if not avoided, may result in minor or moderate injury. It may also be used to alert against unsafe practices.
-  **NOTE** .....Indicates situations that may result in equipment or property-damage accidents only.

- Do not install the unit in an area where flammable materials are present due to risk of explosion resulting in serious injury or death.
- Any abnormalities in the operation of the air conditioner or heat pump, such as smoke or fire, could result in severe injury or death. Turn off the power and contact your dealer immediately.
- Refrigerant gas may produce toxic gas if it comes into contact with fire, such as from a fan, heater, stove, or cooking device. Exposure to this gas could cause severe injury or death.
- For refrigerant leakage, consult your dealer. Refrigerant gas is heavier than air and replaces oxygen. A massive leak could lead to oxygen depletion, especially in basements, and an asphyxiation hazard could occur leading to serious injury or death.
- If equipment utilizing a burner is used in the same room as the air conditioner or heat pump, there is the danger of oxygen deficiency which could lead to an asphyxiation hazard resulting in serious injury or death. Be sure to ventilate the room sufficiently to avoid this hazard.
- Safely dispose of the packing materials. Packing materials, such as nails and other metal or wooden parts, may cause stabs or other injuries.
- Tear apart and throw away plastic packaging bags so that children will not play with them. Children playing with plastic bags face the danger of death by suffocation.
- Contact your dealer for repair and maintenance. Improper repair and maintenance may result in water leakage, electric shock, and fire. Only use accessories made by Daikin that are specifically designed for use with the equipment and have them installed by a professional.
- Contact your dealer to move and reinstall the air conditioner or heat pump. Incomplete installation may result in water leakage, electric shock, and fire.
- Never let the indoor unit or the remote controller get wet. Water can cause an electric shock or a fire.
- Never use flammable spray such as hair spray, lacquer, or paint near the unit. Flammable spray may cause a fire.
- When a fuse blows out, never replace it with one of incorrect ampere ratings or different wires. Always replace any blown fuse with a fuse of the same specification.
- Never remove the fan guard of the unit. A fan rotating at high speed without the fan guard is very dangerous.
- Never inspect or service the unit by yourself. Contact a qualified service person to perform this work.
- Turn off all electrical power before doing any maintenance to avoid the risk of serious electric shock; never sprinkle or spill water or liquids on the unit.
- Do not touch the switch with wet fingers. Touching a switch with wet fingers can cause electric shock.
- Do not allow children to play on or around the unit to prevent injury.
- The heat exchanger fins are sharp enough to cut. To avoid injury wear gloves or cover the fins while working around them.
- Do not put a finger or other objects into the air inlet or air outlet. The fan is rotating at high speed and will cause injury.
- Check the unit foundation for damage on a continuous basis, especially if it has been in use for a long time. If left in a damaged condition the unit may fall and cause injury.
- Placing a flower vase or other containers with water or other liquids on the unit could cause a shock or fire if a spill occurs.
- Do not touch the air outlet or horizontal blades while the swing flap is in operation because fingers could get caught and injured.
- Never touch the internal parts of the controller. Do not remove the front panel because some parts inside are dangerous to touch. To check and adjust internal parts, contact your dealer.
- Do not use the air conditioner or heat pump for any other purposes other than comfort cooling or heating. Do not use the unit for cooling precision instruments, food, plants, animals or works of art.
- Do not place items under the indoor unit as they may be damaged by condensates that may form if the humidity is above 80% or if the drain outlet gets blocked.



- Before cleaning, stop the operation of the unit by turning the power off or by pulling the supply cord out from its receptacle. Otherwise, an electric shock and injury may result.
- Do not wash the air conditioner or heat pump with excessive water. An electric shock or fire may result.
- Avoid placing the controller in a spot splashed with water. Water entering the controller may cause an electric shock or damage the internal electronic parts.
- Do not operate the air conditioner or heat pump when using a room-fumigation type of insecticide. Failure to observe this could cause the chemicals to be deposited in the unit and can endanger the health of those who are hypersensitive to chemicals.
- Do not turn off the power immediately after stopping operation. Always wait for at least five minutes before turning off the power. Otherwise, water leakage may occur.
- The appliance is not intended for use by young children or infirm persons without supervision.
- The remote controller should be kept away from children so they cannot play with it.
- Consult with the installation contractor for cleaning.
- Incorrect cleaning of the inside of the air conditioner or heat pump could make the plastics parts break and cause water leakage or electric shock.
- Do not touch the air inlet or aluminum fin of the air conditioner or heat pump as they can cut and cause injury.
- Do not place objects in direct proximity of the outside unit. Do not let leaves and other debris accumulate around the unit. Leaves are a hotbed for small animals which can enter the unit. Once inside the unit, animals can cause the unit to malfunction, and cause smoke or fire when they make contact with electrical parts.
- Never press the button of the remote controller with a hard, pointed object. The remote controller may be damaged.
- Never pull or twist the electric wire of the remote controller. It may cause the unit to malfunction.
- Do not place appliances that produce open flames in places that are exposed to the air flow of the unit or under the indoor unit. It may cause incomplete combustion or deformation of the unit due to the heat.
- Do not expose the controller to direct sunlight. The LCD display can become discolored and may fail to display the data.
- Do not wipe the controller operation panel with benzene, thinner, chemical dust cloth, etc. The panel may get discolored or the coating can peel off. If it is heavily dirty, soak a cloth in water-diluted neutral detergent, squeeze it well and wipe the panel clean. Then wipe it with another dry cloth.
- Dismantling of the unit, disposal of the refrigerant, oil, and additional parts, should be done in accordance with the relevant local, state, and national regulations.
- Operate the air conditioner or heat pump in a sufficiently ventilated area and not surrounded by obstacles. Do not use the air conditioner or heat pump in the following places.
  - a. Places with a mist of mineral oil, such as cutting oil.
  - b. Locations such as coastal areas where there is a lot of salt in the air.
  - c. Locations such as hot springs where there is a lot of sulfur in the air.
  - d. Locations such as factories where the power voltage varies a lot.
  - e. In cars, boats, and other vehicles.
  - f. Locations such as kitchens where oil may splatter or where there is steam in the air.
  - g. Locations where equipment produces electromagnetic waves.
  - h. Places with an acid or alkaline mist.
  - i. Places where fallen leaves can accumulate or where weeds can grow.
- Take snow protection measures. Contact your dealer for the details of snow protection measures, such as the use of a snow protection hood.
- Do not attempt to do electrical work or grounding work unless you are licensed to do so. Consult with your dealer for electrical work and grounding work.
- Pay Attention to Operating Sound. Be sure to use the following places:
  - a. Places that can sufficiently withstand the weight of the air conditioner or heat pump yet can suppress the operating sound and vibration.
  - b. Places where warm air from the air outlet of the outside unit or the operating sound of the outside unit does not annoy neighbors.
- Make sure that there are no obstacles close to the outside unit. Obstacles close to the outside unit may drop the performance of the outside unit or increase the operating sound of the outside unit.
- Consult your dealer if the air conditioner or heat pump in operation generates unusual noise.
- Make sure that the drainpipe is installed properly to drain water. If no water is discharged from the drainpipe while the air conditioner or heat pump is in the cooling mode, the drainpipe may be clogged with dust or dirt and water leakage from the indoor unit may occur. Stop operating the air conditioner or heat pump and contact your dealer.

# Names of Parts

## Indoor Unit

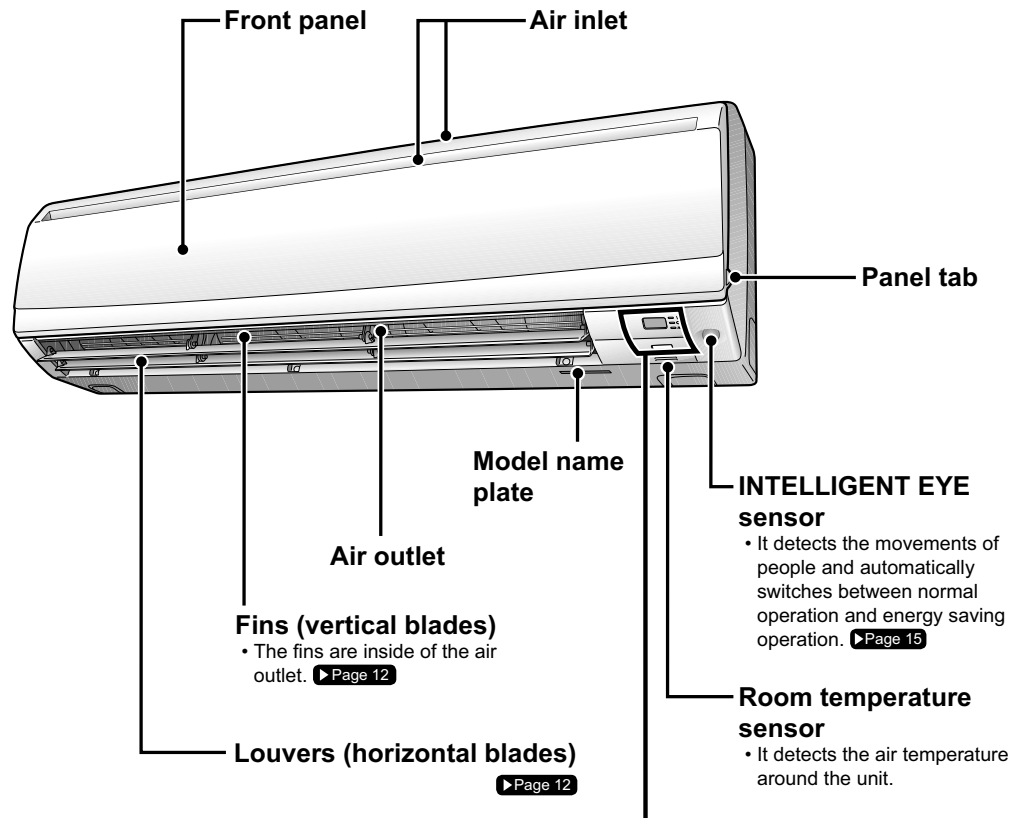

## Display

### Signal receiver

- It receives signals from the remote controller.
- When the unit receives a signal, you will hear a beep sound.
  - Operation start..... beep-beep
  - Settings changed..... beep
  - Operation stop ..... long beep

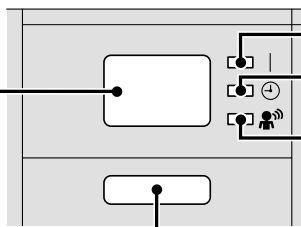

**OPERATION lamp (green)**

**TIMER lamp (yellow)** ▶Page 20

**INTELLIGENT EYE lamp (green)** ▶Page 15

### Indoor unit ON/OFF switch

- Push this switch once to start operation. Push once again to stop it.
- The operation mode refer to the following table.

| Model        | Mode | Temperature setting | Airflow rate |
|--------------|------|---------------------|--------------|
| COOLING ONLY | COOL | 72°F (22°C)         | AUTO         |
| HEAT PUMP    | AUTO | 77°F (25°C)         | AUTO         |

- This switch is useful when the remote controller is missing.

**Open the front panel**

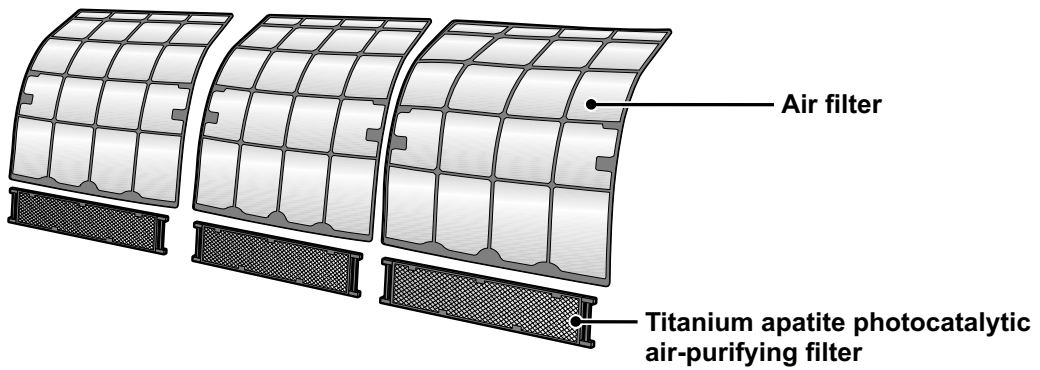
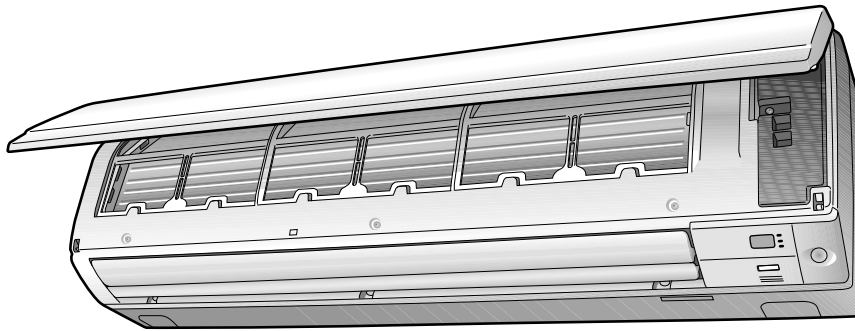

**Outdoor Unit**

• Appearance of the outdoor unit may differ from some models.

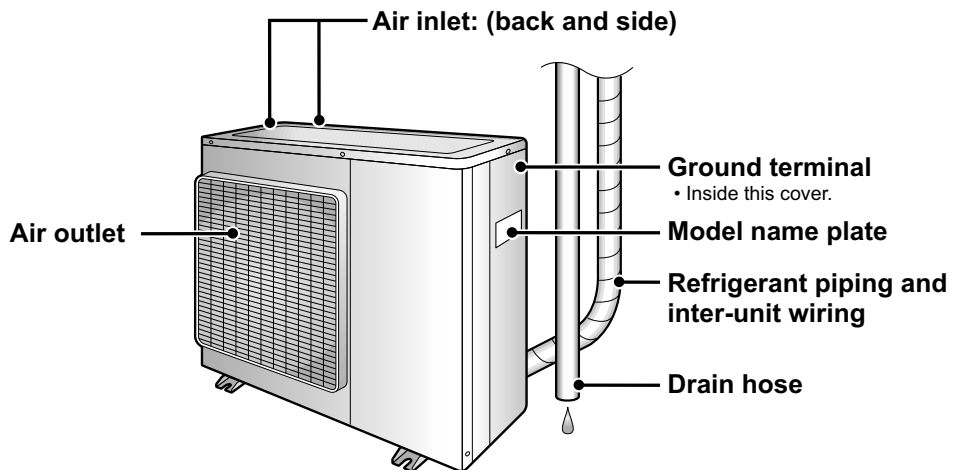

# Names of Parts

## Remote Controller: ARC452A21

### Signal transmitter

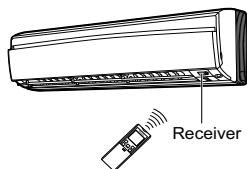

- To use the remote controller, aim the transmitter at the indoor unit. If there is anything to block signals between the unit and the remote controller, such as a curtain, the unit will not operate.
- Do not drop the remote controller. Do not get it wet.
- The maximum distance for communication is approximately 23ft (7m).

### FAN setting button

- Selects the airflow rate setting. ▶Page 11

### POWERFUL button

- POWERFUL operation ▶Page 17

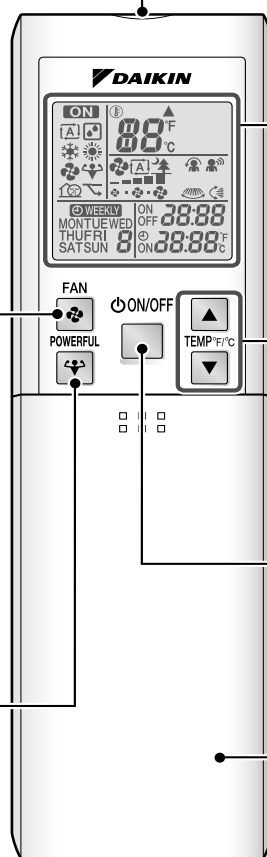

### Display (LCD)

- It displays the current settings. (In this illustration, each section is shown with its displays on for the purpose of explanation.)

### TEMPERATURE adjustment buttons

- Changes the temperature setting. ▶Page 10

### ON/OFF button

- Press this button once to start operation. Press once again to stop it. ▶Page 10

### Front cover

- Open the front cover. ▶Page 7

Open the front cover

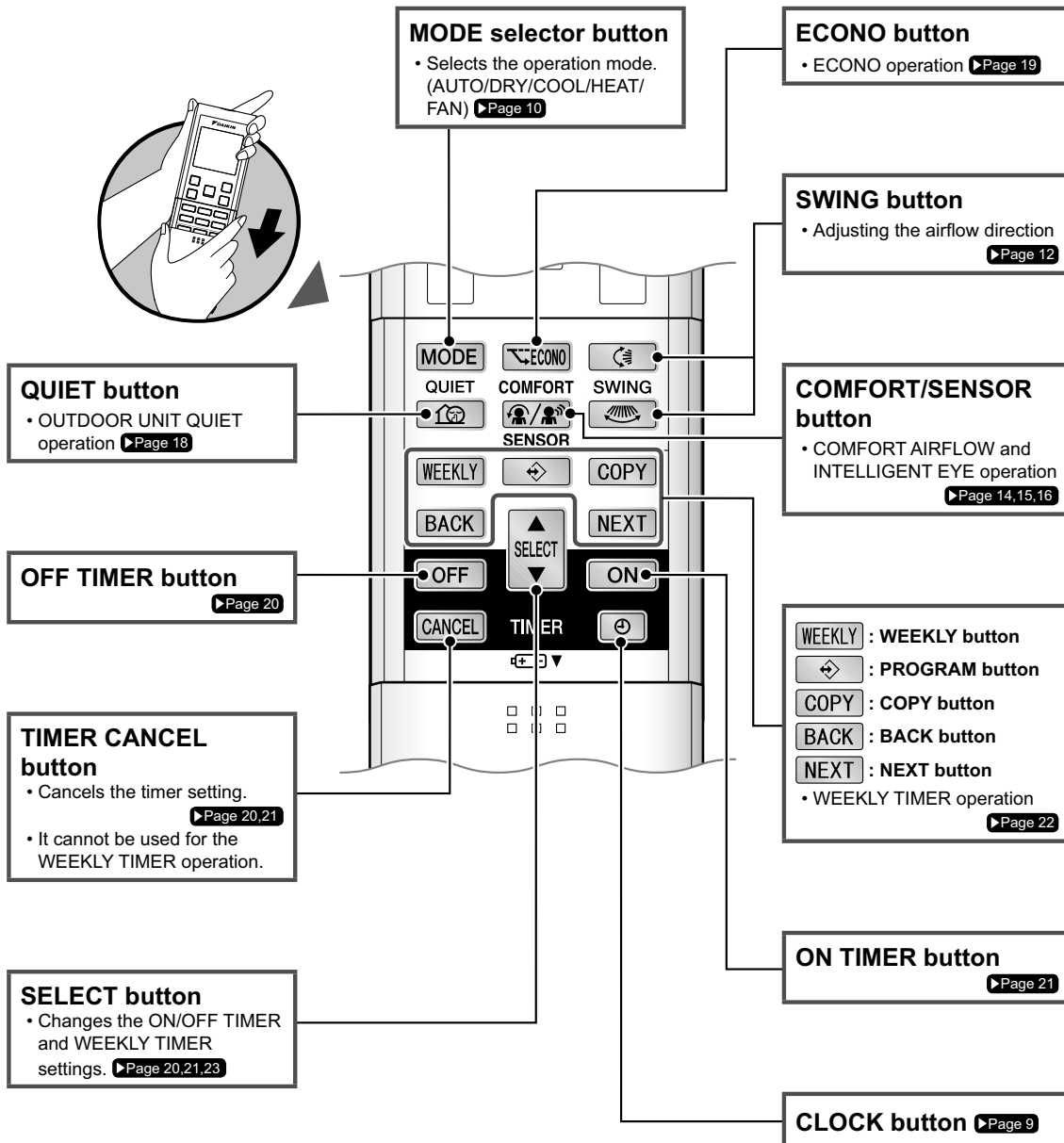

# Preparation before Operation

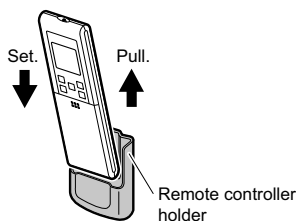
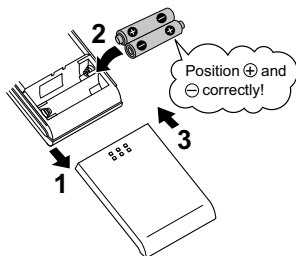

## ■ To set the batteries



1. Slide the front cover to take it off.
2. Set two dry batteries AAA.LR03 (alkaline).
3. Set the front cover as before.

## ■ To fix the remote controller holder on the wall

1. Choose a place from where the signals reach the unit.
2. Fix the holder to a wall, a pillar, etc. with the screws supplied with the holder.
3. Place the remote controller in the remote controller holder.

## ■ Celsius/Fahrenheit display switch

- The Celsius or Fahrenheit display is selectable with the following buttons.

Press  and  buttons simultaneously for 5 seconds.

- The temperature will be displayed in Fahrenheit if it is presently displayed in Celsius, and vice versa.

## ■ Turn the breaker on

- After the power is turned on, the louver of the indoor unit opens and closes once to set the reference position.

## NOTE

### ■ Notes on batteries

- When replacing the batteries, use batteries of the same type, and replace both batteries at the same time.
- When the system is not used for a long time, take the batteries out.
- The batteries will last for approximately 1 year. If the remote controller display begins to fade and the degradation of reception performance occurs within a year, however, replace both batteries with new, size AAA.LR03 (alkaline).
- The attached batteries are provided for the initial use of the system.  
The usable period of the batteries may be short depending on the manufactured date of the air conditioner.

### ■ Notes on remote controller

- Never expose the remote controller to direct sunlight.
- Dust on the signal transmitter or receiver will reduce the sensitivity. Wipe off dust with soft cloth.
- Signal communication may be disabled if an electronic-starter-type fluorescent lamp (such as inverter-type lamps) is in the room. Consult the shop if that is the case.
- If the remote controller signals happen to operate another appliance, move that appliance to somewhere else, or consult the service shop.

### ■ Celsius/Fahrenheit display change function of remote controller

- The set temperature may increase when the display is changed to Celsius from Fahrenheit, because a fraction of 0.5°C is rounded up.
- Example: A set temperature of 65°F (equivalent to 18.5°C) will be converted into 19°C.  
When the display is changed to Fahrenheit again, the set temperature will be converted into 66°F (equivalent to 19°C) instead of the original set temperature (65°F) but a set temperature of 66°F (equivalent to 19°C) will be converted into 19°C with no temperature change.
- A reception sound will go off for the transmission of set temperature to the indoor unit at the time of setting the Celsius/Fahrenheit display change function.

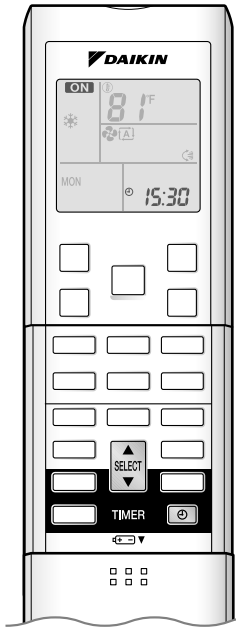

### ■ Checks on remote controller settings

- This remote controller is common to the heat pump model and cooling only model. Use the DIP switch on the remote controller to set the heat pump model or cooling only model.
- Refer to the following explanation and make the setting as shown in the illustration.
  - For customers of heat pump model: Set to H/P
  - For customers of cooling only model: Set to C/O

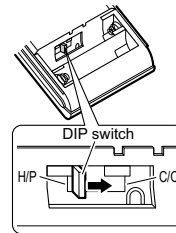

### ■ To set the clock

1. Press .



"0:00" is displayed.  
"MON" and "⏻" blinks.

2. Press to set the current day of the week.

3. Press .



"⏻" blinks.

4. Press to set the clock to the present time.

- Holding down or rapidly increases or decreases the time display.

5. Press .

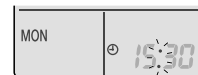

- Point the remote controller at the indoor unit when pressing the buttons.
- "." blinks.

## Operating conditions

- If the indoor unit's internal clock is not set to the correct time, the WEEKLY TIMER will not operate punctually.

### ■ Tips for saving energy

- Be careful not to cool (heat) the room too much. Keeping the temperature setting at a moderate level helps save energy.
- Cover windows with a blind or a curtain. Blocking sunlight and air from outdoors increases the cooling (heating) effect.
- Clogged air filters cause inefficient operation and waste energy. Clean them once in about every 2 weeks.

#### Recommended temperature setting

For cooling: 78-82°F (26-28°C)  
For heating: 68-75°F (20-24°C)

### ■ Please note

- The air conditioner always consumes a small amount of electricity even while it is not operating.
- If you are not going to use the air conditioner for a long period, for example in spring or autumn, turn the breaker off.
- Use the air conditioner in the following conditions.

| Mode | Operating conditions   | If operation is continued out of this range  |
|------|--|--|
| COOL | Outdoor temperature : 50-115°F (10-46°C)<br>Indoor temperature : 64-90°F (18-32°C)<br>Indoor humidity : 80% max. | <ul style="list-style-type: none"> <li>• A safety device may work to stop the operation.</li> <li>• Condensation may occur on the indoor unit and drip.</li> </ul> |
| HEAT | Outdoor temperature : 5-75°F (-15-24°C)<br>Indoor temperature : 50-86°F (10-30°C)                                | <ul style="list-style-type: none"> <li>• A safety device may work to stop the operation.</li> </ul>  |
| DRY  | Outdoor temperature : 50-115°F (10-46°C)<br>Indoor temperature : 64-90°F (18-32°C)<br>Indoor humidity : 80% max. | <ul style="list-style-type: none"> <li>• A safety device may work to stop the operation.</li> <li>• Condensation may occur on the indoor unit and drip.</li> </ul> |

- Operation outside this humidity or temperature range may cause a safety device to disable the system.

# AUTO · DRY · COOL · HEAT · FAN Operation

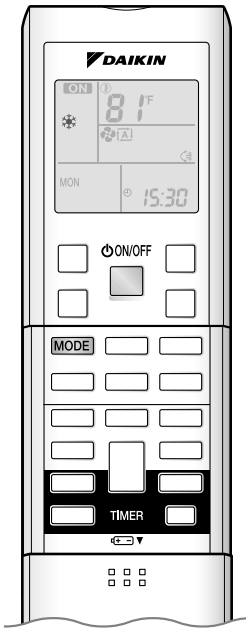

The air conditioner operates with the operation mode of your choice. From the next time on, the air conditioner will operate with the same operation mode.

## ■ To start operation

### 1. Press **MODE** and select a operation mode.

- Each pressing of the button advances the mode setting in sequence.

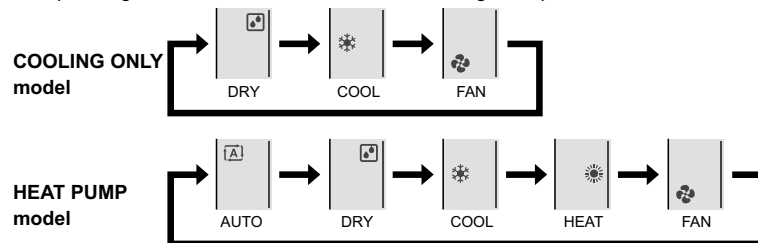

### 2. Press **ON/OFF**.

- “ON” is displayed on the LCD.
- The OPERATION lamp lights green.

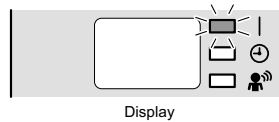

## ■ To stop operation

Press **ON/OFF** again.

- “ON” is no longer displayed on the LCD.
- The OPERATION lamp goes off.

## ■ To change the temperature setting

Press **TEMP<sup>F/C</sup>** (up arrow) or **TEMP<sup>F/C</sup>** (down arrow).

- The displayed items on the LCD will change whenever either one of the buttons is pressed.



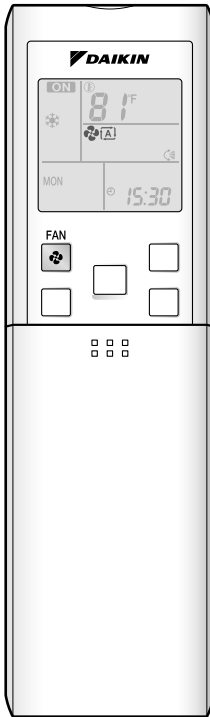

| DRY or FAN mode                          | COOL mode  | HEAT mode            | AUTO mode            |
|--|--|----------------------|----------------------|
| The temperature setting is not variable. | 64-90°F<br>(18-32°C)   | 50-86°F<br>(10-30°C) | 64-86°F<br>(18-30°C) |
|  | Press ▲ to raise the temperature and press ▼ to lower the temperature. |                      |                      |





■ To change the airflow rate setting

Press .

| DRY mode                                  | AUTO or COOL or HEAT or FAN mode  |
|---|---|
| The airflow rate setting is not variable. | Five levels of airflow rate setting from “  ” to “  ” plus “  ” and “  ” are available.  |

- Indoor unit quiet operation  
When the airflow is set to “”, the noise from the indoor unit will become quieter. Use this when making the noise quieter. The unit might lose capacity when the airflow rate is set to a weak level.
- Each pressing of the button advances the airflow rate setting in sequence.

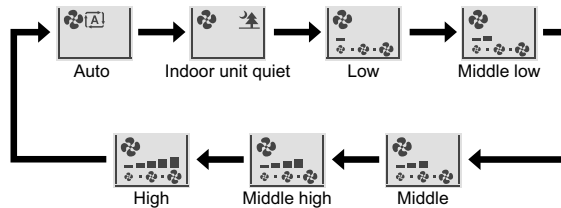

**NOTE**

■ Note on HEAT operation

- Since this air conditioner heats the room by taking heat from outdoor air to indoors, the heating capacity becomes smaller in lower outdoor temperatures. If the heating effect is insufficient, it is recommended to use another heating appliance in combination with the air conditioner.
- The heat pump system heats the room by circulating hot air around all parts of the room. After the start of heating operation, it takes some time before the room gets warmer.
- In heating operation, frost may occur on the outdoor unit and lower the heating capacity. In that case, the system switches into defrosting operation to take away the frost.
- During defrosting operation, hot air does not flow out of indoor unit.

■ Note on COOL operation

- This air conditioner cools the room by releasing the heat in the room outside. Therefore, the cooling performance of the air conditioner may be degraded if the outdoor temperature is high.

■ Note on DRY operation

- The computer chip works to rid the room of humidity while maintaining the temperature as much as possible. It automatically controls temperature and airflow rate, so manual adjustment of these functions is unavailable.

■ Note on AUTO operation

- In AUTO operation, the system selects an appropriate operation mode (COOL or HEAT) based on the room and outside temperatures and starts the operation.
- The system automatically reselects setting at a regular interval to bring the room temperature to user-setting level.

■ Note on FAN operation

- This mode is valid for fan only.

■ Note on airflow rate setting

- At smaller airflow rates, the cooling (heating) effect is also smaller.

# Adjusting the Airflow Direction

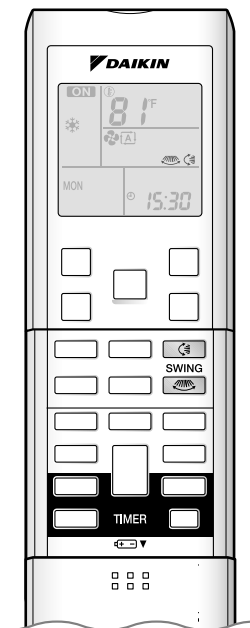



You can adjust the airflow direction to increase your comfort.

## Adjusting the upper and lower airflow direction

### ■ To adjust the louvers (horizontal blades)

**1.** Press .

- “” is displayed on the LCD and the louvers will begin to swing.

**2.** When the louvers have reached the desired position, press  once more.

- The louvers will stop moving.
- “” is no longer displayed on the LCD.

## Adjusting the right and left airflow direction

### ■ To adjust the fins (vertical blades)

**3.** Press .

- “” is displayed on the LCD.

**4.** When the fins have reached the desired position, press the  once more.

- The fins will stop moving.
- “” is no longer displayed on the LCD.

**Adjusting the 3-D airflow direction**

■ **To start 3-D airflow**

1. 3. Press the  and the  :  
the “” and “” display will light up and the louvers and fins will move in turn.

■ **To cancel 3-D airflow**

2. 4. Press either the  or the .

■ **COMFORT AIRFLOW operation**

- Check COMFORT AIRFLOW operation in the section of “COMFORT AIRFLOW Operation” and “INTELLIGENT EYE Operation”.  Page 14,15

**NOTE**

■ **Notes on louvers and fins angles**

- When “SWING button” is selected, the louvers swinging range depends on the operation. (See the figure.)

**Three-dimensional (3-D) airflow**

- Using three-dimensional airflow circulates cold air, which tends to be collected at the bottom of the room, and hot air, which tends to collect near the ceiling, throughout the room, preventing areas of cold and hot developing.

■ **ATTENTION**

- Always use a remote controller to adjust the angles of the louvers and fins. If you attempt to move it forcibly with hand when it is swinging, the mechanism may be broken.
- Always use a remote controller to adjust the fins angles. In side the air outlet, a fan is rotating at a high speed.

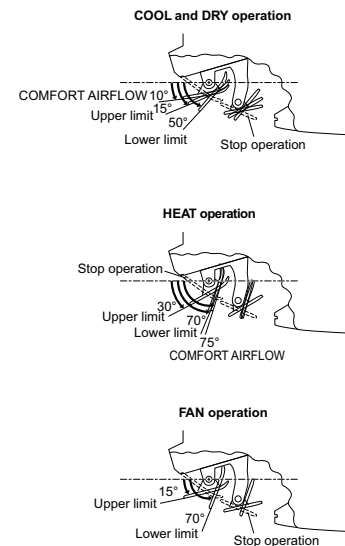

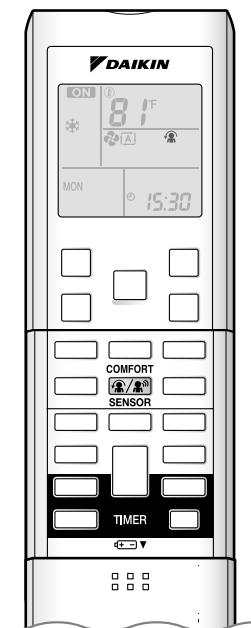

# COMFORT AIRFLOW Operation



The flow of air will be in the upward direction while in COOL operation and in the downward direction while in HEAT operation, providing comfortable cool or warm air that does not come in direct contact with people.

## ■ To start COMFORT AIRFLOW operation

### 1. Press and select “” on the LCD.

- Each time the  is pressed a different setting option is displayed on the LCD.
- By selecting “” from the following icons, the air conditioner will be in COMFORT AIRFLOW operation combined with INTELLIGENT EYE operation. [▶Page 16](#)



## ■ To cancel COMFORT AIRFLOW operation

### 2. Press .

- Press the button to select “Blank”.

## NOTE

### ■ Notes on COMFORT AIRFLOW operation

- The louvers position will change, preventing air from blowing directly on the occupants of the room.
- POWERFUL operation and COMFORT AIRFLOW operation cannot be used at the same time.
- The volume of air will be set to AUTO. If the upward and downward airflow direction is selected, the COMFORT AIRFLOW function will be canceled.
- Priority is given to the function of whichever button is pressed last.
- The COMFORT AIRFLOW function makes the following airflow direction adjustments.  
The louvers will move upward while cooling so that the airflow will be directed upward.  
The louvers will move downward while heating so that the airflow will be directed downward.

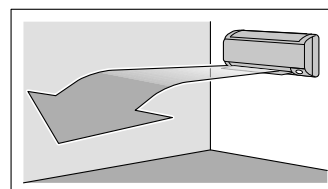

COOL operation

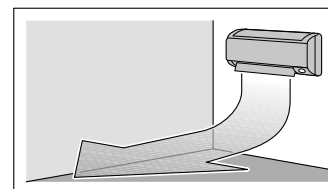

HEAT operation

# INTELLIGENT EYE Operation

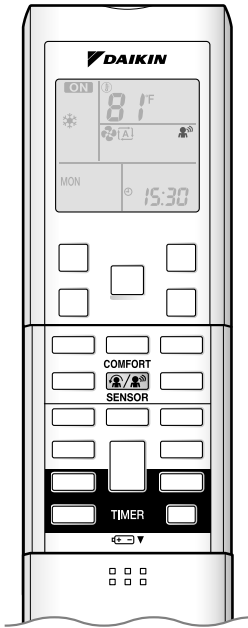

“INTELLIGENT EYE” is the infrared sensor which detects the human movement.

## ■ To start INTELLIGENT EYE operation

### 1. Press and select “” on the LCD.

- Each time the  is pressed a different setting option is displayed on the LCD.
- The INTELLIGENT EYE lamp lights green.

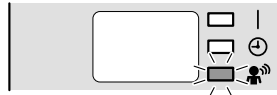

Display

- By selecting “” from the following icons, the air conditioner will be in INTELLIGENT EYE operation combined with COMFORT AIRFLOW operation. [▶Page 16](#)



- When the louvers (horizontal blades) are swinging, the operating as above will stop movement of them.
- The lamp will be lit while human movements are detected.

## ■ To cancel the INTELLIGENT EYE operation

### 2. Press .

- Press the button to select “Blank”.

[EX.]

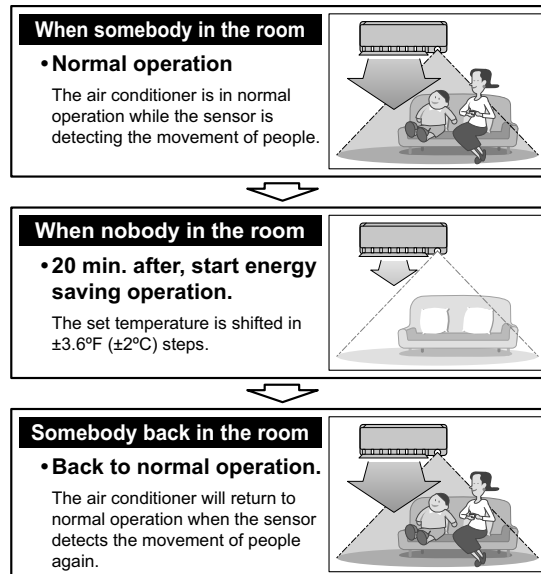

# INTELLIGENT EYE Operation

## “INTELLIGENT EYE” is useful for energy saving

### ■ Energy saving operation

- Change the temperature  $-3.6^{\circ}\text{F}$  ( $-2^{\circ}\text{C}$ ) in heating /  $+3.6^{\circ}\text{F}$  ( $+2^{\circ}\text{C}$ ) in cooling /  $+3.6^{\circ}\text{F}$  ( $+2^{\circ}\text{C}$ ) in dry mode from set temperature. When the room temperature exceeds  $86^{\circ}\text{F}$  ( $30^{\circ}\text{C}$ ), the operation changes the temperature  $+1.8^{\circ}\text{F}$  ( $+1^{\circ}\text{C}$ ) in COOL /  $+1.8^{\circ}\text{F}$  ( $+1^{\circ}\text{C}$ ) in DRY mode from set temperature.
- Decrease the airflow rate slightly in FAN mode only.
- If no presence detected in the room for 20 minutes.

## NOTE

### ■ Notes on “INTELLIGENT EYE”

- Application range is as follows.

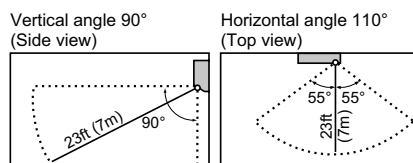

- Sensor may not detect moving objects further than 23ft (7m) away. (Check the application range)
- Sensor detection sensitivity changes according to indoor unit location, the speed of passersby, temperature range, etc.
- The sensor also mistakenly detects pets, sunlight, fluttering curtains and light reflected off of mirrors as passersby.
- INTELLIGENT EYE operation will not go on during POWERFUL operation.
- NIGHT SET mode (Page 20) will not go on during use of INTELLIGENT EYE operation.

## ■ To combine “COMFORT AIRFLOW operation” and “INTELLIGENT EYE operation”

### 1. Press and select “” on the LCD.

- Each time the  is pressed a different setting option is displayed on the LCD.



## ■ To cancel “COMFORT AIRFLOW operation” and “INTELLIGENT EYE operation”

### 2. Press .

- Press the button to select “Blank”.

- The air conditioner can go into operation with the COMFORT AIRFLOW and INTELLIGENT EYE functions combined.
  - The volume of air will be set to AUTO. If the upward and downward airflow direction is selected, the COMFORT AIRFLOW operation will be canceled.
- Priority is given to the function of whichever button is pressed last.

## CAUTION

- Do not place large objects near the sensor.  
Also keep heating units or humidifiers outside the sensor's detection area. This sensor can detect undesirable objects.
- Do not hit or forcefully push the INTELLIGENT EYE sensor. This can lead to damage and malfunction.

# POWERFUL Operation

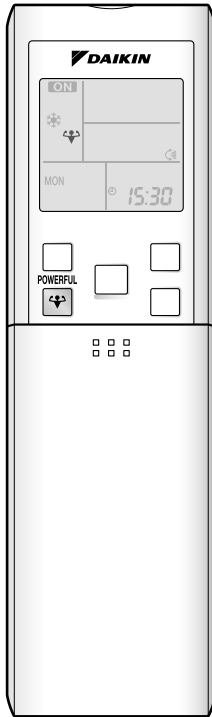

POWERFUL operation quickly maximizes the cooling (heating) effect in any operation mode. You can get the maximum capacity.

## ■ To start POWERFUL operation

Press  during operation.

- POWERFUL operation ends in 20 minutes. Then the system automatically operates again with the previous settings which were used before POWERFUL operation.
- “” is displayed on the LCD.
- When using POWERFUL operation, there are some functions which are not available.

## ■ To cancel POWERFUL operation

Press  again.

- “” is no longer displayed on the LCD.

## NOTE

### ■ Notes on POWERFUL operation

- POWERFUL operation cannot be used together with ECONO, COMFORT AIRFLOW or QUIET operation.
- POWERFUL operation will not increase the capacity of the air conditioner if the air conditioner is already in operation with its maximum capacity demonstrated.
- **In COOL, HEAT and AUTO operation**  
To maximize the cooling (heating) effect, the capacity of outdoor unit is increased and the airflow rate is fixed to the maximum setting. The temperature and airflow settings are not variable.
- **In DRY operation**  
The temperature setting is lowered by 4.5°F (2.5°C) and the airflow rate is slightly increased.
- **In FAN operation**  
The airflow rate is fixed to the maximum setting.

# OUTDOOR UNIT QUIET Operation

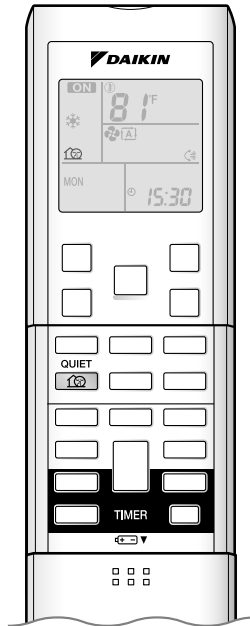

OUTDOOR UNIT QUIET operation lowers the noise level of the outdoor unit by changing the frequency and fan speed on the outdoor unit. This function is convenient during night.

## ■ To start OUTDOOR UNIT QUIET operation

Press .

- “” is displayed on the LCD.

## ■ To cancel OUTDOOR UNIT QUIET operation

Press  again.

- “” is no longer displayed on the LCD.

## NOTE

### ■ Notes on OUTDOOR UNIT QUIET operation

- This function is available in COOL, HEAT, and AUTO operation.  
(This is not available in FAN and DRY operation.)
- POWERFUL operation and OUTDOOR UNIT QUIET operation cannot be used at the same time.  
Priority is given to the function of whichever button is pressed last.
- If operation is stopped using the remote controller or the indoor unit ON/OFF switch when using OUTDOOR UNIT QUIET operation, “” will remain on the remote controller display.
- OUTDOOR UNIT QUIET operation will drop neither the frequency nor fan speed if the frequency and fan speed have been already dropped low enough.



# ECONO Operation

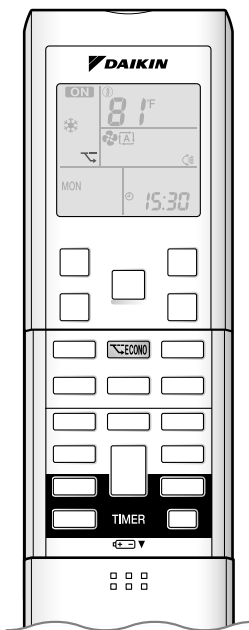

ECONO operation is a function which enables efficient operation by limiting the maximum power consumption value. This function is useful for cases in which attention should be paid to ensure a circuit breaker will not trip when the product runs alongside other appliances.

## ■ To start ECONO operation

Press **ECONO** during operation.

- "ECONO" is displayed on the LCD.

## ■ To cancel ECONO operation

Press **ECONO** again.

- "ECONO" is no longer displayed on the LCD.

Running current and power consumption

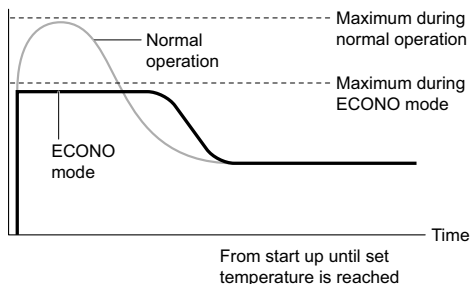

- This diagram is a representation for illustrative purposes only. The maximum running current and power consumption of the air conditioner in ECONO operation vary with the connecting outdoor unit.

## NOTE

### ■ Notes on ECONO operation

- ECONO operation can only be set when the unit is running. Pressing the operation stop button causes the settings to be canceled, and the "ECONO" is no longer displayed on the LCD.
- ECONO operation is a function which enables efficient operation by limiting the power consumption of the outdoor unit (operating frequency).
- ECONO operation functions in AUTO, COOL, DRY, and HEAT operation.
- POWERFUL and ECONO operation cannot be used at the same time. Priority is given to the function of whichever button is pressed last.
- If the level of power consumption is already low, ECONO operation will not drop the power consumption.

# TIMER Operation

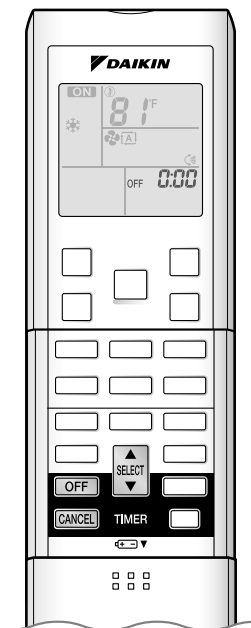

Timer functions are useful for automatically switching the air conditioner on or off at night or in the morning. You can also use OFF TIMER and ON TIMER in combination.

## ■ To use OFF TIMER operation

- Check that the clock is correct.  
If not, set the clock to the present time. ▶Page 9

### 1. Press **OFF**.



"0:00" is displayed.  
"OFF" blinks.

- "🕒" and day of the week are no longer displayed on the LCD.

### 2. Press **SELECT** until the time setting reaches the point you like.



- Each pressing of either button increases or decreases the time setting by 10 minutes.  
Holding down either button changes the time setting rapidly.

### 3. Press **OFF** again.

- "OFF" and setting time are displayed on the LCD.
- The TIMER lamp lights yellow.



Display

## ■ To cancel OFF TIMER operation

Press **CANCEL**.

- "OFF" and setting time are no longer displayed on the LCD.
- "🕒" and day of the week are displayed on the LCD.
- The TIMER lamp goes off.

## NOTE

### ■ Notes on TIMER operation

- When TIMER is set, the present time is not displayed.
- Once you set ON, OFF TIMER, the time setting is kept in the memory. (The memory is canceled when remote controller batteries are replaced.)
- When operating the unit via the ON/OFF TIMER, the actual length of operation may vary from the time entered by the user. (Maximum approximately 10 minutes)

### ■ NIGHT SET mode

When the OFF TIMER is set, the air conditioner automatically adjusts the temperature setting (0.9°F (0.5°C) up in COOL, 3.6°F (2.0°C) down in HEAT) to prevent excessive cooling (heating) for your pleasant sleep.

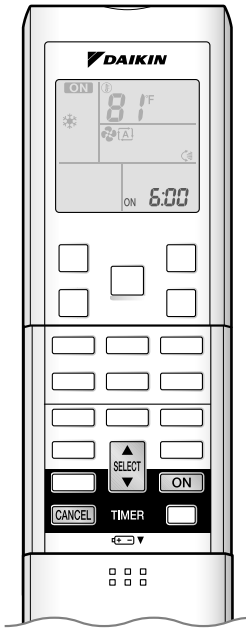

### ■ To use ON TIMER operation

- Check that the clock is correct.  
If not, set the clock to the present time. ▶Page 9

#### 1. Press **ON**.



- “6:00” is displayed.
- “ON” blinks.
- “⌚” and day of the week are no longer displayed on the LCD.

#### 2. Press **SELECT** until the time setting reaches the point you like.

- Each pressing of either button increases or decreases the time setting by 10 minutes.
- Holding down either button changes the time setting rapidly.

#### 3. Press **ON** again.

- “ON” and setting time are displayed on the LCD.
- The TIMER lamp lights yellow.

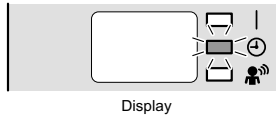

### ■ To cancel ON TIMER operation

Press **CANCEL**.

- “ON” and setting time are no longer displayed on the LCD.
- “⌚” and day of the week are displayed on the LCD.
- The TIMER lamp goes off.

### ■ To combine ON TIMER and OFF TIMER

- A sample setting for combining the 2 timers is shown below.

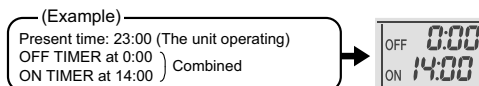

### NOTE

#### ■ In the following cases, set the timer again.

- After a breaker has turned off.
- After a power failure.
- After replacing batteries in the remote controller.

# WEEKLY TIMER Operation

Up to 4 timer settings can be saved for each day of the week. It is convenient if the WEEKLY TIMER is set according to the family's life style.

## ■ Using in these cases of WEEKLY TIMER

An example of WEEKLY TIMER settings is shown below.

**Example:** The same timer settings are made for the week from Monday through Friday while different timer settings are made for the weekend.

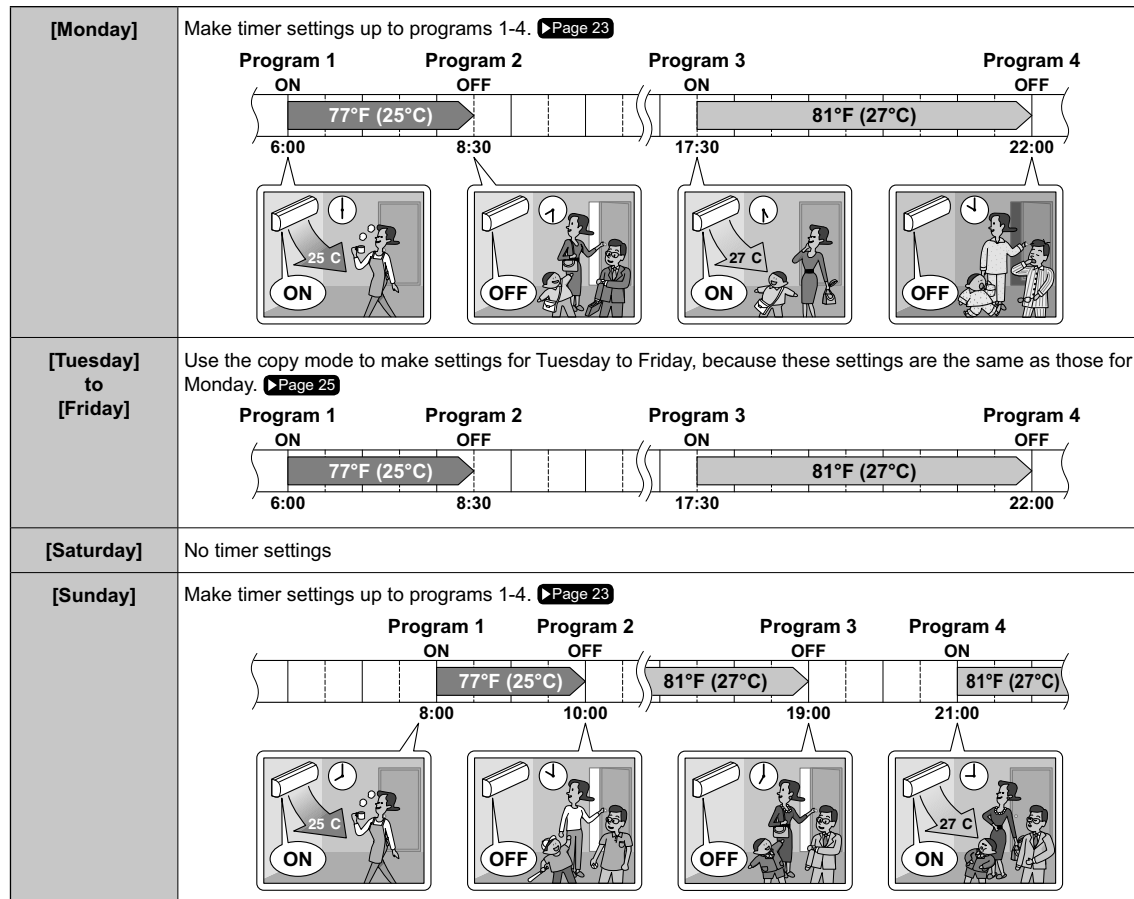

- Up to 4 reservations per day and 28 reservations per week can be set in the WEEKLY TIMER. The effective use of the copy mode ensures ease of making reservations.
- The use of ON-ON-ON-ON settings, for example, makes it possible to schedule operating mode and set temperature changes. Furthermore, by using OFF-OFF-OFF-OFF settings, only the turn-off time of each day can be set. This will turn off the air conditioner automatically if the user forgets to turn it off.

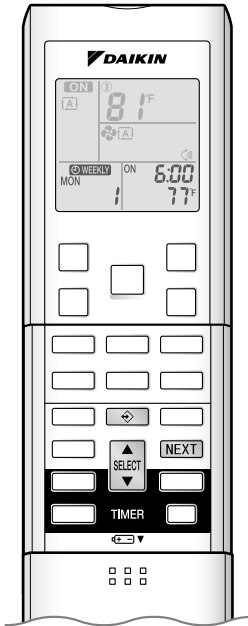

## ■ To use WEEKLY TIMER operation

### Setting mode

- Make sure the day of the week and time are set. If not, set the day of the week and time.
- ▶ Page 9

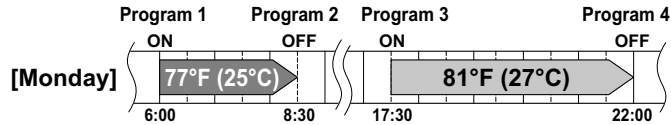

### Setting Displays

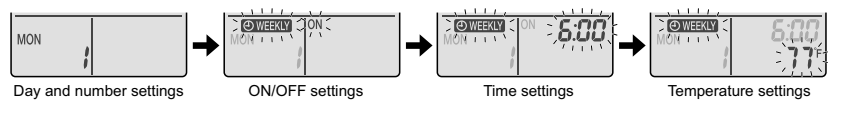

### 1. Press .

- The day of the week and the reservation number of the current day will be displayed.
- 1 to 4 settings can be made per day.

### 2. Press to select the desired day of the week and reservation number.

- Pressing  changes the reservation number and the day of the week.

### 3. Press .

- The day of the week and reservation number will be set.
- "WEEKLY" and "ON" blink.

### 4. Press to select the desired mode.

- Pressing  changes "ON" or "OFF" setting in sequence.

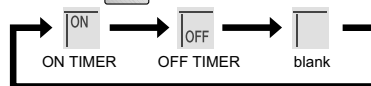

- In case the reservation has already been set, selecting "blank" deletes the reservation.
- Go to STEP 9 if "blank" is selected.

### 5. Press .

- The ON/OFF TIMER mode will be set.
- "WEEKLY" and the time blink.

# WEEKLY TIMER Operation

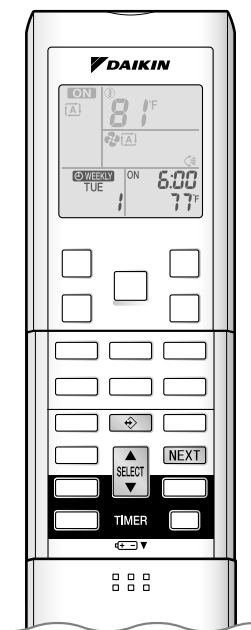

## 6. Press to select the desired time.

- The time can be set between 0:00 and 23:50 in 10 minute intervals.
- To return to the ON/OFF TIMER mode setting, press **BACK**.
- Go to STEP 9 when setting the OFF TIMER.

## 7. Press .

- The time will be set.
- “ WEEKLY” and the temperature blink.

## 8. Press to select the desired temperature.

- The temperature can be set between 50°F (10°C) and 90°F (32°C).  
Cooling: The unit operates at 64°F (18°C) even if it is set at 50 (10) to 63°F (17°C).  
Heating: The unit operates at 86°F (30°C) even if it is set at 87 (31) to 90°F (32°C).
- To return to the time setting, press **BACK**.
- The set temperature is only displayed when the mode setting is on.

## 9. Press .

- The temperature will be set and go to the next reservation setting.
- To continue further settings, repeat the procedure from STEP 4.

## 10. Press to complete the setting.

- Be sure to direct the remote controller toward the indoor unit and check for a receiving tone and flashing the operation lamp.
- “ WEEKLY” is displayed on the LCD and WEEKLY TIMER operation is activated.
- The TIMER lamp lights yellow.





Display

- A reservation made once can be easily copied and the same settings used for another day of the week. Refer to **Copy mode**. ▶Page 25

## NOTE

### ■ Notes on WEEKLY TIMER operation

- Do not forget to set the clock on the remote controller first. ▶Page 9
- The day of the week, ON/OFF TIMER mode, time and set temperature (only for ON TIMER mode) can be set with WEEKLY TIMER. Other settings for ON TIMER are based on the settings just before the operation.
- Both WEEKLY TIMER and ON/OFF TIMER operation cannot be used at the same time. The ON/OFF TIMER operation has priority if it is set while WEEKLY TIMER is still active. The WEEKLY TIMER will go into standby state, and “ WEEKLY” will be no longer displayed on the LCD. When ON/OFF TIMER is up, the WEEKLY TIMER will automatically become active.
- Only the time and set temperature set with the weekly timer are sent with the .  
Set the weekly timer only after setting the operation mode, the fan strength, and the fan direction ahead of time.
- Shutting the breaker off, power failure, and other similar events will render operation of the indoor unit's internal clock inaccurate. Reset the clock. ▶Page 9
- The **BACK** can be used only for the time and temperature settings.  
It cannot be used to go back to the reservation number.

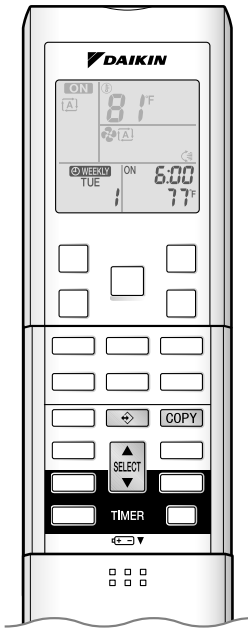





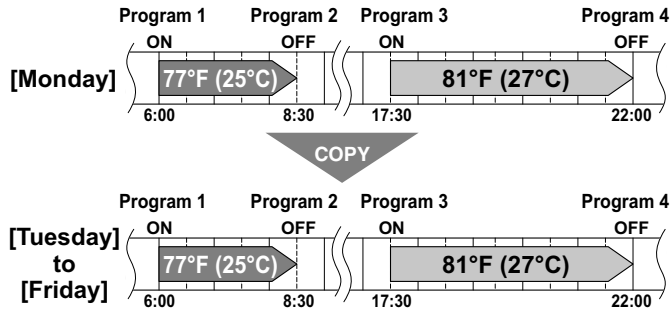

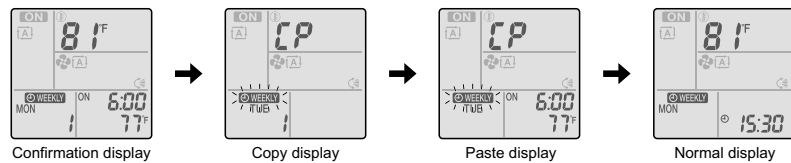

**Copy mode**

• A reservation made once can be copied another day of the week. The whole reservation of the selected day of the week will be copied.





**Setting Displays**



1. Press .
2. Press  to confirm the day of the week to be copied.
3. Press  to activate copy mode.
  - The whole reservation of the selected day of the week will be copied.
4. Press  to select the destination day of the week.
5. Press .
  - The reservation will be copied to the selected day of the week. The whole reservation of the selected day of the week will be copied.
  - To continue copying the settings to other days of the week, repeat STEP 4 and STEP 5.
6. Press  to complete the setting.
  - “ WEEKLY” is displayed on the LCD and WEEKLY TIMER operation is activated.

**NOTE**

■ Notes on copy mode

- The entire reservation of the source day of the week is copied in the copy mode.  
In the case of making a reservation change for any day of the week individually after copying the content of weekly reservations, press  and change the settings in the steps of **Setting mode** .  Page 23

# WEEKLY TIMER Operation

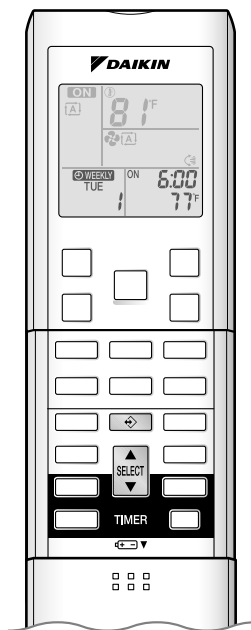

## ■ Confirming a reservation

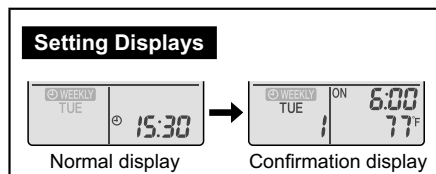

- The reservation can be confirmed.



### 1. Press .

- The day of the week and the reservation number of the current day will be displayed.

### 2. Press to select the day of the week and the reservation number to be confirmed.

- Pressing  displays the reservation details.
- To change the confirmed reserved settings, select the reservation number and press . The mode is switched to setting mode. Go to **Setting mode** STEP 4. 

### 3. Press to exit confirming mode.

- “ WEEKLY” is displayed on the LCD and WEEKLY TIMER operation is activated.
- The TIMER lamp lights yellow.

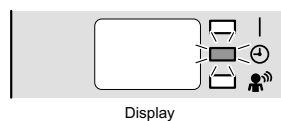



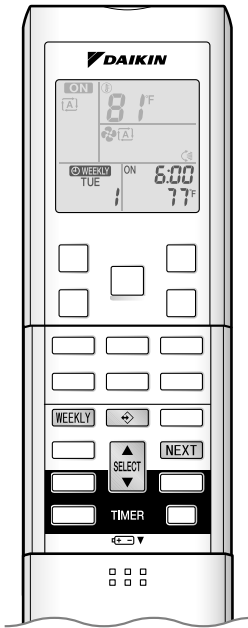

■ To deactivate WEEKLY TIMER operation

Press **WEEKLY** while “**WEEKLY**” is displayed on the LCD.

- The “**WEEKLY**” will be no longer displayed on the LCD.
- The TIMER lamp goes off.
- To reactivate the WEEKLY TIMER operation, press **WEEKLY** again.
- If a reservation deactivated with **WEEKLY** is activated once again, the last reservation mode will be used.

■ To delete reservations

**The individual reservation**

1. Press .

- The day of the week and the reservation number will be displayed.

2. Press  to select the day of the week and the reservation number to be deleted.

3. Press **NEXT**.

- “**WEEKLY**” and “ON” or “OFF” blink.
- Pressing  changes ON/OFF TIMER mode.

The reservation has no setting when selecting “blank”.

4. Press  and select “blank”.

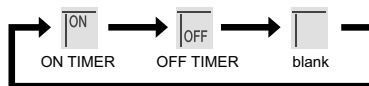

5. Press **NEXT**.

- The selected reservation will be deleted.

# WEEKLY TIMER Operation

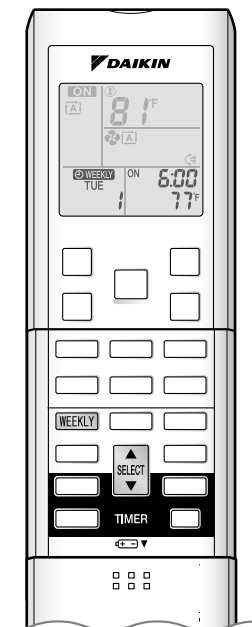

## The reservations for each day of the week

- This function can be used for deleting reservations for each day of the week.

1. Press .

2. Press  to select the day of the week to be deleted.

3. Hold  for 5 seconds.

- The reservation of the selected day of the week will be deleted.

## All reservations

Hold  for 5 seconds while normal display.

- Be sure to direct the remote controller toward the indoor unit and check for a receiving tone.
- This operation is not effective while WEEKLY TIMER is being set.
- All reservations will be deleted.

# Care and Cleaning



## CAUTION

Before cleaning, be sure to stop the operation and turn the breaker off.

### Units

#### Indoor unit and remote controller

- Wipe them with a soft cloth when dirty.

#### Front panel

### 1. Open the front panel.

- Hold the front panel by the panel tabs on the both sides and open it.

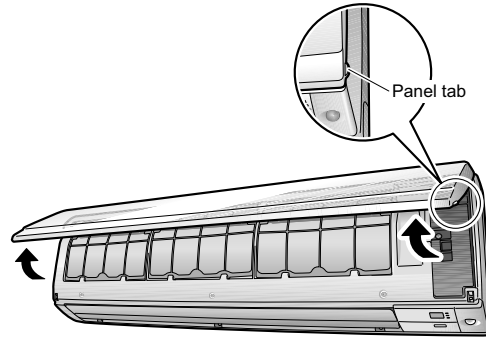

### 2. Remove the front panel.

- Slide the front panel to either the left or right and pulling it toward you. This will disconnect the front panel shaft on one side.

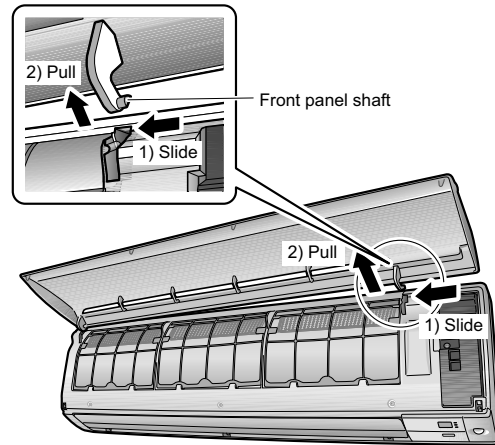

### 3. Clean the front panel.

- Wipe it with a soft cloth soaked in water.
- Only neutral detergent may be used.
- In case of washing the panel with water, wipe it with dry soft cloth, dry it up in the shade after washing.

### 4. Attach the front panel.

- Align the front panel shaft on the left and right of the front panel with the slots, then push them all the way in.
- Close the front panel slowly. (Press the panel at both sides and the central area.)

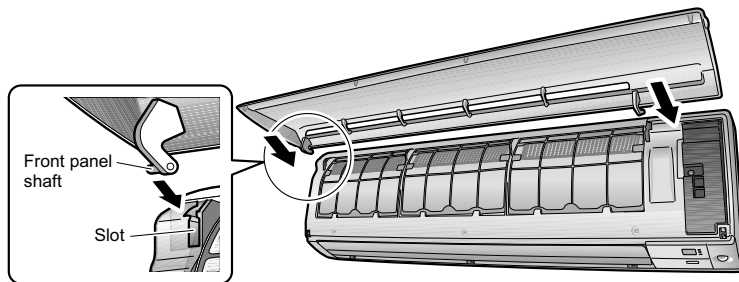

## CAUTION

- Do not touch the aluminum fins of the indoor unit. If you touch those parts, this may cause an injury.
- When removing or attaching the front panel, use a robust and stable stool and watch your steps carefully.
- When removing or attaching the front panel, support the panel securely with hand to prevent it from falling.
- For cleaning, do not use hot water above 104°F (40°C), benzene, gasoline, thinner, nor other volatile oils, polishing compound, scrubbing brushes, nor other hand stuff.
- After cleaning, make sure that the front panel is securely fixed.

# Care and Cleaning

## Filters

**1. Open the front panel.** ▶Page 29

**2. Pull out the air filters.**

- Push the filter tab at the center of each air filter slightly upward, then pull it down.

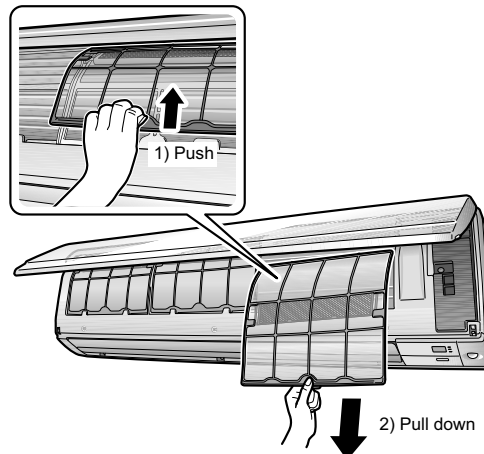

**3. Take off the titanium apatite photocatalytic air-purifying filter.**

- Hold the recessed parts of the frame and unhook the 4 claws.

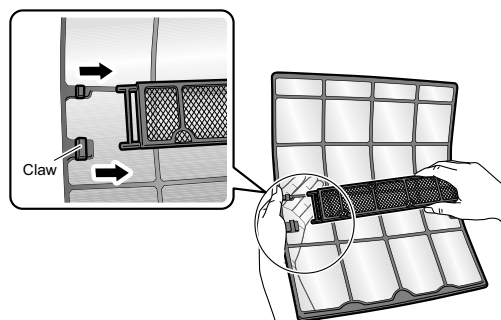

**4. Clean or replace each filters.**

**5. Set the filters as they were and close the front panel.**

- Press the front panel at both sides and the central area.

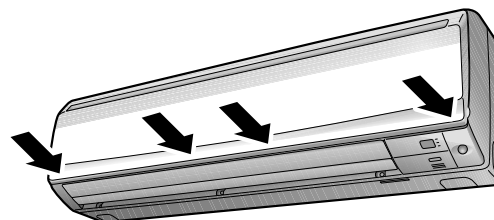

## ⚠ CAUTION

- Do not touch the aluminum fins by bare hand at the time of dismantling or mounting the filter.

### Air filter

#### Wash the air filters with water or clean them with vacuum cleaner.

- If the dust does not come off easily, wash them with neutral detergent thinned with lukewarm water, then dry them up in the shade.
- It is recommended to clean the air filters every 2 weeks.



### Titanium apatite photocatalytic air-purifying filter

The titanium apatite photocatalytic air-purifying filter can be renewed by washing it with water once every 6 months.

We recommend replacing it once every 3 years.

### [ Maintenance ]

#### 1. Vacuum dusts, and soak in warm water or water for about 10 to 15 minutes if dirt is heavy.

- Do not remove the filter from frame when washing with water.

#### 2. After washing, shake off remaining water and dry in the shade.

- Since the material is made out of polyester, do not wring out the filter when removing water from it.

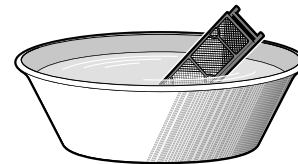

### [ Replacement ]

#### 1. Remove the tabs on the filter frame and replace with a new filter.

- Dispose of the old filter as non-flammable waste.

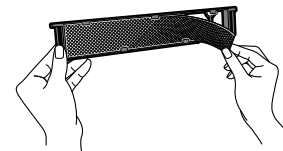

# Care and Cleaning

## NOTE

- Operation with dirty filters:
  - 1) cannot deodorize the air.
  - 2) cannot clean the air.
  - 3) results in poor heating or cooling.
  - 4) may cause odor.
- To order titanium apatite photocatalytic air-purifying filter contact to the service shop there you purchased the air conditioner.
- Dispose of old filters as non-flammable waste.

| Item   | Part No.  |
|--|-----------|
| Titanium apatite photocatalytic air-purifying filter (without frame) 1 set | KAF970A48 |

## ATTENTION



- Do not throw away the filter frame. Reuse the filter frame when replacing the titanium apatite photocatalytic air-purifying filter.

## CHECK

- Check that the base, stand and other fittings of the outdoor unit are not decayed or corroded.
- Check that nothing blocks the air inlets and the outlets of the indoor unit and the outdoor unit.
- Check that the drain comes smoothly out of the drain hose during COOL or DRY operation.
  - If no drain water is seen, water may be leaking from the indoor unit. Stop operation and consult the service shop if this is the case.

### Before a long idle period.

## 1. Operate the “FAN only” for several hours on a nice day to dry out the inside.

- Press **MODE** and select “” operation.
- Press  and start the operation.

## 2. After operation stops, turn off the breaker for the room air conditioner.

## 3. Clean the air filters and set them again.

## 4. Take out batteries from the remote controller.

# Troubleshooting

## These cases are not troubles.

The following cases are not air conditioner troubles but have some reasons. You may just continue using it.

| Case   | Explanation   |
|--|---|
| <p><b>Operation does not start soon.</b></p> <ul style="list-style-type: none"> <li>• When ON/OFF button was pressed soon after operation was stopped.</li> <li>• When the mode was reselected.</li> </ul> | <ul style="list-style-type: none"> <li>• This is to protect the air conditioner. You should wait for about 3 minutes.</li> </ul>  |
| <p><b>Hot air does not flow out soon after the start of heating operation.</b></p>   | <ul style="list-style-type: none"> <li>• The air conditioner is warming up. You should wait for 1 to 4 minutes. (The system is designed to start discharging air only after it has reached a certain temperature.)</li> </ul>   |
| <p><b>The HEAT operation stops suddenly and a flowing sound is heard.</b></p>  | <ul style="list-style-type: none"> <li>• The outdoor unit is taking away the frost. The HEAT operation starts after the frost on the outdoor unit is removed. You should wait for about 4 to 12 minutes.</li> </ul>   |
| <p><b>Possible sounds.</b></p>   | <ul style="list-style-type: none"> <li>■ <b>Flowing water</b> <ul style="list-style-type: none"> <li>• Generated because the refrigerant in the air conditioner is flowing.</li> <li>• This is a pumping sound of the water in the air conditioner it is heard when the water is pumped out from the air conditioner in cooling or drying operation.</li> <li>• The refrigerant flows in the air conditioner even if the air conditioner is not working when the indoor units in other rooms are in operation.</li> </ul> </li> <li>■ <b>Blowing</b> <ul style="list-style-type: none"> <li>• Generated when the flow of the refrigerant in the air conditioner is switched over.</li> </ul> </li> <li>■ <b>Ticking</b> <ul style="list-style-type: none"> <li>• Generated when the size of the air conditioner slightly expands or shrinks as a result of temperature changes.</li> </ul> </li> <li>■ <b>Whistling</b> <ul style="list-style-type: none"> <li>• Generated when refrigerant flows during defrosting operation.</li> </ul> </li> <li>■ <b>Clicking</b> <ul style="list-style-type: none"> <li>• Generated when the refrigerant control valves or the electrical parts operate.</li> </ul> </li> <li>■ <b>Clopping</b> <ul style="list-style-type: none"> <li>• Heard from the inside of the air conditioner when the exhaust fan is activated while the room doors are closed. Open the window or turn off the exhaust fan.</li> </ul> </li> </ul> |
| <p><b>The outdoor unit emits water or steam.</b></p>   | <ul style="list-style-type: none"> <li>■ <b>In HEAT operation</b> <ul style="list-style-type: none"> <li>• The frost on the outdoor unit melts into water or steam when the air conditioner is in defrost operation.</li> </ul> </li> <li>■ <b>In COOL or DRY operation</b> <ul style="list-style-type: none"> <li>• Moisture in the air condenses into water on the cool surface of outdoor unit piping and drips.</li> </ul> </li> </ul>  |
| <p><b>Mist comes out of the indoor unit.</b></p>   | <ul style="list-style-type: none"> <li>■ This happens when the air in the room is cooled into mist by the cold airflow during cooling operation.</li> <li>■ This is because the air in the room is cooled by the heat exchanger and becomes mist during defrost operation.</li> </ul>   |
| <p><b>The indoor unit gives out odor.</b></p>  | <ul style="list-style-type: none"> <li>■ This happens when smells of the room, furniture, or cigarettes are absorbed into the unit and discharged with the airflow. If this happens, have the indoor unit washed by a technician from the service shop where you purchased the air conditioner.</li> </ul>  |

# Troubleshooting

| Case  | Explanation  |
|---|--|
| The outdoor fan rotates while the air conditioner is not in operation.  | <ul style="list-style-type: none"> <li>■ After operation is stopped:               <ul style="list-style-type: none"> <li>• The outdoor fan continues rotating for another 60 seconds for system protection.</li> </ul> </li> <li>■ While the air conditioner is not in operation:               <ul style="list-style-type: none"> <li>• When the outdoor temperature is very high, the outdoor fan starts rotating for system protection.</li> </ul> </li> </ul> |
| The operation stopped suddenly. (OPERATION lamp is on.)   | <ul style="list-style-type: none"> <li>• For system protection, the air conditioner may stop operating on a sudden large voltage fluctuation. It automatically resumes operation in about 3 minutes.</li> </ul>  |
| No remote controller signals are displayed. The remote controller sensitivity is low. The display is low in contrast or blacked out. The display runs out of control. | <ul style="list-style-type: none"> <li>• The batteries are dying and the remote controller is malfunctioning. Replace all the batteries with new size batteries, AAA.LR03 (alkaline). For details, refer to set the batteries of this manual. ▶Page 8</li> </ul>   |
| The ON/OFF TIMER does not operate according to the settings.  | <ul style="list-style-type: none"> <li>• Check if the ON/OFF TIMER and the WEEKLY TIMER are set to the same time. Change or disable the settings in the WEEKLY TIMER. ▶Page 23</li> </ul>  |

## Check again.

Please check again before calling a repair person.

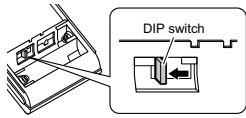
| Case  | Check   |
|---|---|
| The air conditioner does not operate. (OPERATION lamp is off.)              | <ul style="list-style-type: none"> <li>• Is a breaker off or a fuse blown?</li> <li>• Is there a power failure?</li> <li>• Are batteries set in the remote controller?</li> <li>• Is the timer setting correct?</li> </ul>  |
| Cooling (Heating) effect is poor.   | <ul style="list-style-type: none"> <li>• Are the air filters clean?</li> <li>• Is there anything to block the air inlet or the outlet of the indoor and the outdoor units?</li> <li>• Is the temperature setting appropriate?</li> <li>• Are the windows and doors closed?</li> <li>• Are the airflow rate and the air direction set appropriately?</li> </ul>  |
| Operation stops suddenly. (OPERATION lamp flashes.)                         | <ul style="list-style-type: none"> <li>• Are the air filters clean?<br/>Clean the air filters.</li> <li>• Is there anything to block the air inlet or the outlet of the indoor and the outdoor units?</li> <li>• Turn the breaker off and take all obstacles away. Then turn it on again and try operating the air conditioner with the remote controller. If the lamp still flashes, call the service shop where you purchased the air conditioner.</li> </ul> |
| An abnormal functioning happens during operation.                           | <ul style="list-style-type: none"> <li>• The air conditioner may malfunction with lightning or radio waves. Turn the breaker off, turn it on again and try operating the air conditioner with the remote controller.</li> </ul>   |
| The flap does not start swinging immediately.                               | <ul style="list-style-type: none"> <li>• The air conditioner is adjusting the flap position. The flap will start moving soon.</li> </ul>  |
| HEAT operation cannot be selected, even though the unit is heat pump model. | <ul style="list-style-type: none"> <li>• Slide the DIP switch to the left as shown in the illustration so that the HEAT operation can be selected with the "MODE" button.</li> </ul>   |



■ **Call the service shop immediately.**

 **WARNING**

- **When an abnormality (such as a burning smell) occurs, stop operation and turn the breaker off.**
  - Continued operation in an abnormal condition may result in malfunctioning, electric shocks or fire.
  - Consult the service shop where you purchased the air conditioner.
- **Do not attempt to repair or modify the air conditioner by yourself.**
  - Incorrect work may result in electric shocks or fire.
  - Consult the service shop where you purchased the air conditioner.

**If one of the following symptoms occurs, call the service shop immediately.**

- The power cord is abnormally hot or damaged.
- An abnormal sound is heard during operation.
- The safety breaker, a fuse, or the ground leakage breaker cuts off the operation frequently.
- A switch or a button often fails to work properly.
- There is a burning smell.
- Water leaks from the indoor unit.

Turn the breaker off and call the service shop. 

- **After a power failure**
  - The air conditioner automatically resumes operation in about 3 minutes. You should just wait for a while.

- **Lightning**
  - If lightning may strike the neighboring area, stop operation and turn the breaker off for system protection.

■ **We recommend periodical maintenance.**

- In certain operating conditions, the inside of the air conditioner may get foul after several seasons of use, resulting in poor performance. It is recommended to have periodic maintenance by a specialist aside from regular cleaning by the user.
- For specialist maintenance, contact the service shop where you purchased the air conditioner.
- The maintenance cost must be born by the user.

# Troubleshooting

## Fault diagnosis.

### FAULT DIAGNOSIS BY REMOTE CONTROLLER

In the ARC452A series, the temperature display sections on the main unit indicate corresponding codes.

1. When the **TIMER CANCEL** button is held down for 5 seconds, a “00” indication flashes on the temperature display section.

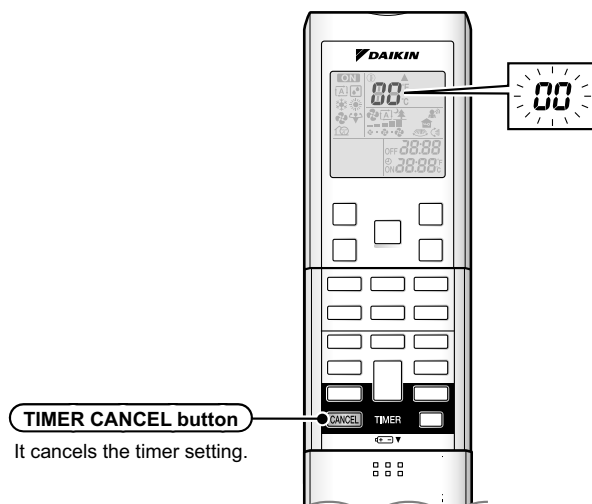

2. Press the **TIMER CANCEL** button repeatedly until a continuous beep is produced.

- The code indication changes as shown below, and notifies with a long beep.

|              | CODE  | MEANING  |
|--------------|---|--|
| SYSTEM       | 00  | NORMAL   |
|              | U0  | REFRIGERANT SHORTAGE   |
|              | U2  | DROP VOLTAGE OR MAIN CIRCUIT OVERVOLTAGE                       |
|              | U4  | FAILURE OF TRANSMISSION (BETWEEN INDOOR UNIT AND OUTDOOR UNIT) |
| INDOOR UNIT  | A1  | INDOOR PCB DEFECTIVENESS                                       |
|              | A5  | HIGH PRESSURE CONTROL OR FREEZE-UP PROTECTOR                   |
|              | A6  | FAN MOTOR FAULT  |
|              | C4  | FAULTY HEAT EXCHANGER TEMPERATURE SENSOR                       |
|              | C9  | FAULTY SUCTION AIR TEMPERATURE SENSOR                          |
| OUTDOOR UNIT | EA  | COOLING-HEATING SWITCHING ERROR                                |
|              | E5  | OL STARTED   |
|              | E6  | FAULTY COMPRESSOR START UP                                     |
|              | E7  | DC FAN MOTOR FAULT   |
|              | E8  | OPERATION HALT DUE TO DETECTION OF INPUT OVER CURRENT          |
|              | F3  | HIGH TEMPERATURE DISCHARGE PIPE CONTROL                        |
|              | H6  | OPERATION HALT DUE TO FAULTY POSITION DETECTION SENSOR         |
|              | H8  | CT ABNORMALITY   |
|              | H9  | FAULTY SUCTION AIR TEMPERATURE SENSOR                          |
|              | J3  | FAULTY DISCHARGE PIPE TEMPERATURE SENSOR                       |
|              | J6  | FAULTY HEAT EXCHANGER TEMPERATURE SENSOR                       |
|              | L4  | HIGH TEMPERATURE AT INVERTER CIRCUIT HEATSINK                  |
|              | L5  | OUTPUT OVERCURRENT   |
| P4           | FAULTY INVERTER CIRCUIT HEATSINK TEMPERATURE SENSOR |  |

## NOTE

- A short beep and two consecutive beeps indicate non-corresponding codes.
- To cancel the code display, hold the **TIMER CANCEL** button down for 5 seconds. The code display also cancel itself if the button is not pressed for 1 minute.

3P228444-4J

## 13. Optional Accessories

### 13.1 Option List

#### 13.1.1 Indoor Unit

|   | Option Name  | Model Name   |
|---|--|--------------|
| 1 | Wired remote controller  | BRC944B2-A08 |
| 2 | Centralized Control Board-Up to 5 Rooms ★1   | KRC72        |
| 3 | Wiring Adaptor for Timer Clock / Remote Controller ★2<br>(Normal Open Pulse Contact / Normal Open Contact) | KRP413AB1S   |
| 4 | Central Remote Controller (Fahrenheit) ★3  | DCS302C71    |
| 5 | Unified ON/OFF Controller ★3   | DCS301C71    |
| 6 | Schedule Timer Controller ★3   | DST301BA61   |
| 7 | Interface Adaptor for DIII-NET (Residential Air Conditioner)   | KRP928BB2S   |
| 8 | Titanium Apatite Photocatalytic Air-purifying Filter<br>(Without frame) ★4                                 | KAF970A48    |
| 9 | Remote Controller Loss Prevention with Chain   | KKF910A4     |

**Note:**

- ★1 A wiring adaptor (KRP413AB1S) is also required for each indoor unit.
- ★2 Timer clock and other devices ; obtained locally.
- ★3 An interface adaptor (KRP928BB2S) is also required for each indoor unit.
- ★4 Standard accessory

#### 13.1.2 Outdoor Unit

|   | Option Name                     | Model Name |
|---|---------------------------------|------------|
| 1 | Air Direction Adjustment Grille | KPW5E112   |
| 2 | Drain Plug ★                    | KKP945A4   |

**Note:**

- ★ Standard accessory for heat pump models

## 13.2 <BRC944B2> Wired Remote Controller

### 13.2.1 Installation Manual

#### **⚠ CAUTION**

1. No switch box or staple is supplied. Prepare them locally.
2. No remote controller cord is supplied. Prepare the optional remote controller cord 4 wire.
3. Be sure to turn off the power to any apparatus connected prior to mounting.
4. Prior to mounting equipment, touch something metallic such as a doorknob to remove static electricity from your body. Never touch the remote controller board or the adapter board.
5. Keep the wiring away from any other power source lines to avoid electric noise (external noise).
6. Select a flat surface, wherever possible, to mount the remote controller. To prevent deformation of the cases, do not overtighten the mounting screws.

#### 1. Securing the remote controller lower case

Insert a bladed screwdriver into the concave (凹) in the remote controller lower case to remove the upper case assembly (two locations).

The remote controller board is located on the upper case. Take care not to scratch the board with the screwdriver.

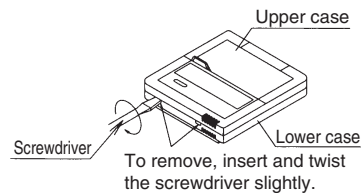

#### (1) Exposed mounting

Secure the remote controller lower case with the two supplied wood screws.

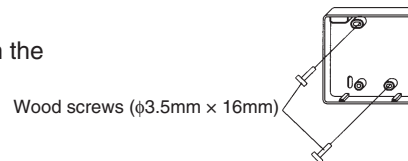

#### (2) Embedded mounting

Secure the remote controller lower case with the two supplied machine screws.

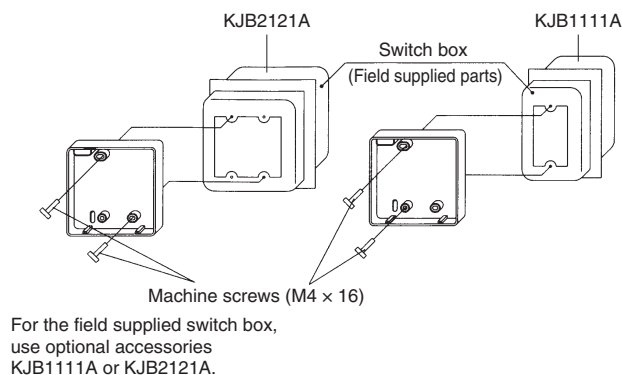

**2. Securing the remote control adapter**

Remove the upper case of the remote control adapter and secure the lower case assembly.

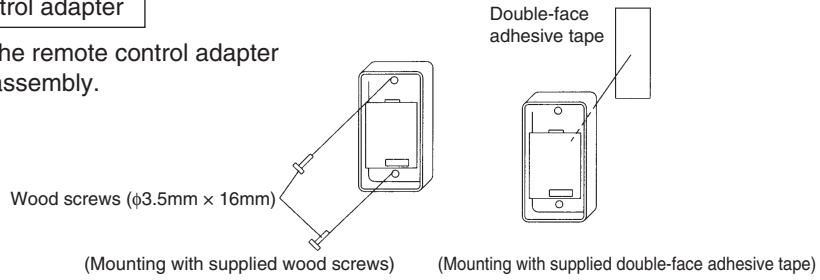

**3. Wiring**

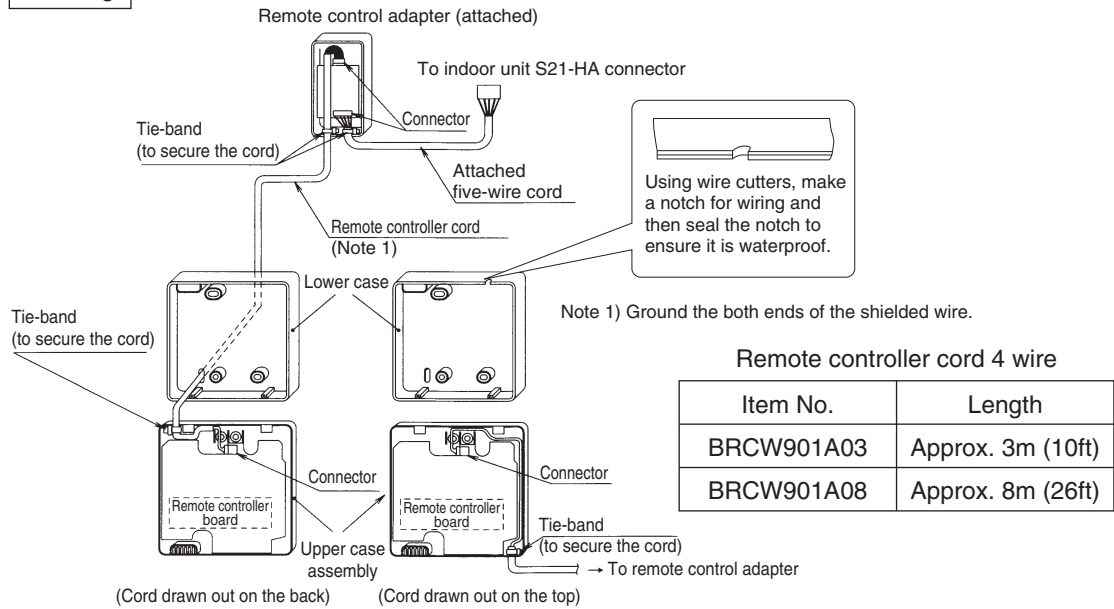

**4. Placing the upper case assembly of the remote controller and the upper case of the remote controller adapter back into their original positions**

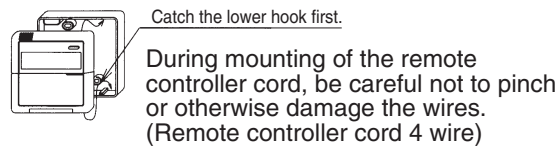

**5. Temperature indication change**

To change from Celsius temperature indication to Fahrenheit one

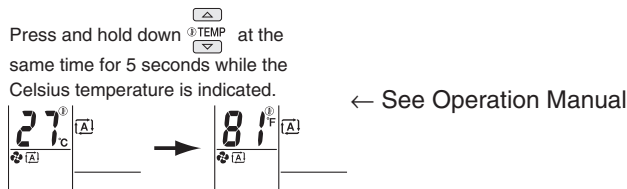

13.2.2 Operation Manual

# Controller Commands and their Corresponding Functions

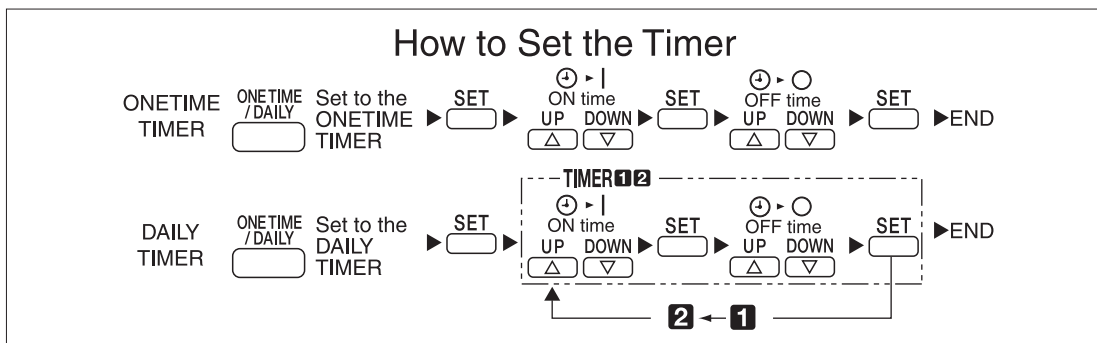
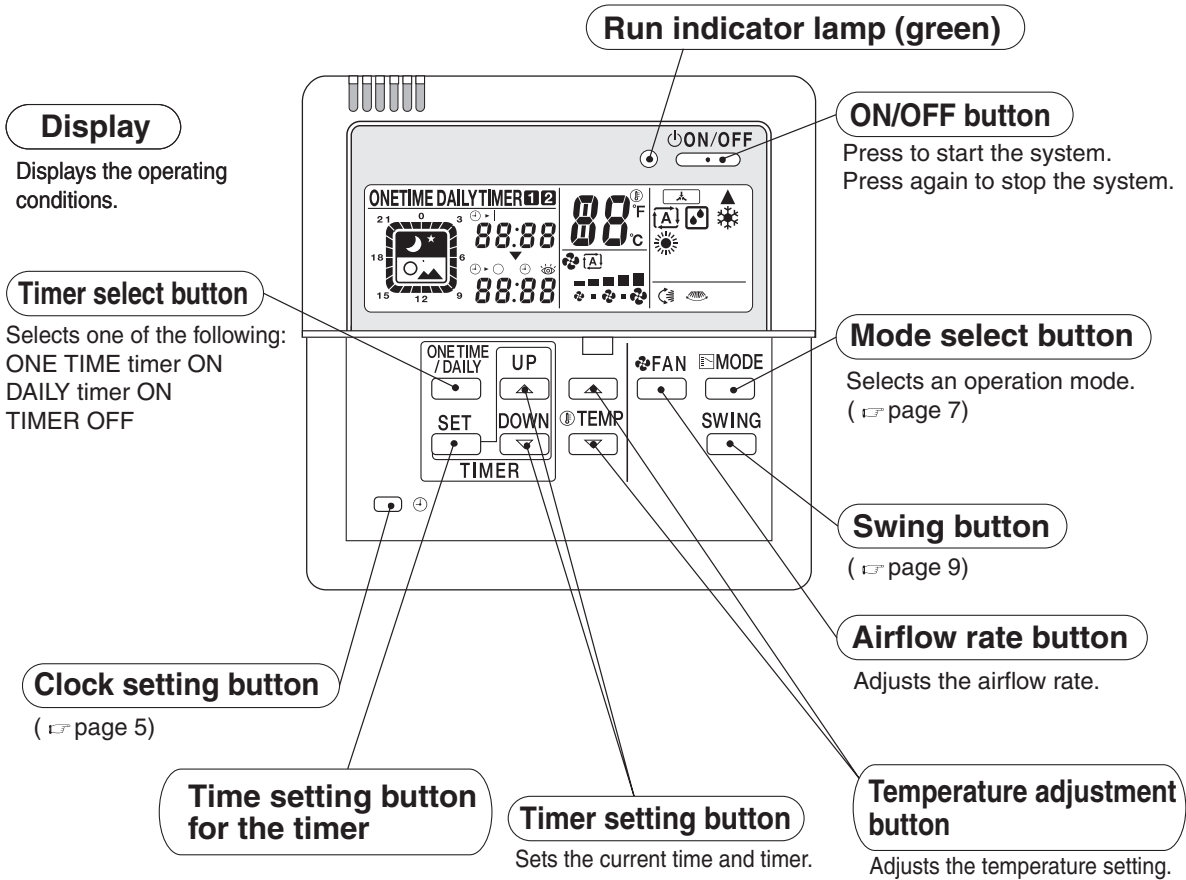

**CAUTION**

• This remote controller cannot be used together with a standard wireless remote controller. Otherwise, what appears on this remote controller's display may fail to correspond to actual operating conditions.

# Preparation before Operation

## ■ Checking the power

If nothing appears on the remote controller's display, turn on the circuit breaker.

## ■ Setting the current time

1 Press .



The current time starts blinking.  
0:00 lights up.

2 Press and set the current time.

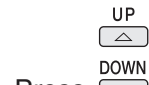

- Hold the button down to rapidly advance the time.

3 Press .

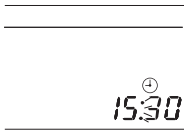

: blinks.  
(This completes the current time setting)

- The clock's accuracy is ±30 seconds per month.

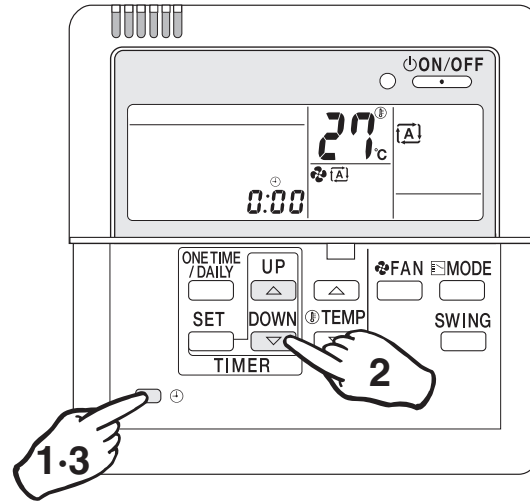

## Notes

### To use the unit efficiently

- Avoid overcooling or overheating. Moderate room temperature setting contributes to power saving.

Recommended temperature setting

For cooling ..... 26~28°C (79°F~82°F)  
For heating ..... 20~22°C (68°F~72°F)

- Hang a blind or a curtain on the window. This will enhance the cooling/heating effect by intercepting direct sunlight and drafts.
- A clogged air filter reduces the cooling/heating effect and wastes energy. Clean the air filter monthly (every two weeks as required) or so.

### Please take note of the following points

- Electric power is consumed even when the air conditioner is not in operation.
- When the unit is not used for a long period of time such as during off-season, turn off the breaker.

### Operating conditions

- If the operation is continued under any conditions other than the following, the safety device may work to stop the operation. Also, dew may form on the indoor unit and drip from it. (Cooling/DRY)

|         |                 |                             |
|---------|-----------------|-----------------------------|
| Cooling | Outdoor temp.   | -10 to 46°C (14°F to 115°F) |
|         | Room temp.      | 18 to 32°C (64°F to 90°F)   |
|         | Indoor humidity | Less than 80%               |
| DRY     | Outdoor temp.   | -10 to 46°C (14°F to 115°F) |
|         | Room temp.      | 18 to 32°C (64°F to 90°F)   |
|         | Indoor humidity | Less than 80%               |
| Heating | Outdoor temp.   | -15 to 20°C (5°F to 68°F)   |
|         | Room temp.      | Less than 27°C              |

- Operation limit differ according to the model.

# Preparation before Operation

## ■ Setting Temperature Indication change

Temperature indication can be changed between Celsius and Fahrenheit before use.

### To change from Celsius temperature indication to Fahrenheit one

- 1 Press and hold down  at the same time for 5 seconds while the Celsius temperature is indicated.

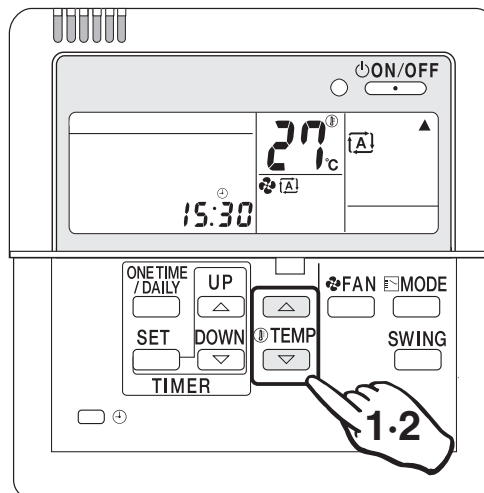
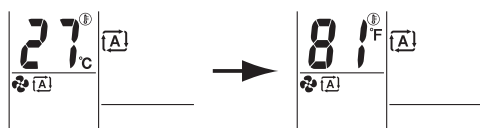

### To change from Fahrenheit temperature indication to Celsius one

- 2 Press and hold down  at the same time for 5 seconds while the Fahrenheit temperature is indicated.



## Notes

### ■ Temperature indication change between Celsius and Fahrenheit on the remote controller

- Change the temperature indication in the modes other than the DRY mode. In the DRY mode, temperature indication setting cannot be changed because the temperature is not indicated.
- When the Fahrenheit temperature indication is changed to Celsius one, the temperature value (0.5°C) will be rounded up. Thus, the preset temperature may be changed.

Example:

A preset temperature of 65°F (equivalent to 18.5°C) will be changed to 19°C (66°F) by changing the temperature indication. In this case, if you change the Celsius temperature indication again to the Fahrenheit one, the preset temperature is shown not as 65°F but as 66°F (equivalent to 19°C). If the preset temperature is 66°F (equivalent to 19°C) and is changed to the Celsius temperature indication, the indication becomes 19°C (66°F). In this case, no change by the temperature indication change is observed.

- When the temperature indication change is set, the preset temperature is transmitted to the indoor unit so that the reception sound will be heard from the indoor unit.



# Automatic·DRY·Cooling·Heating Operation

Select your desired operation mode.

Once preset, the system can get restarted in the same operation mode.

**1** Press  to select your desired operation mode.

- Each time the button is pressed, the mode changes as follows.

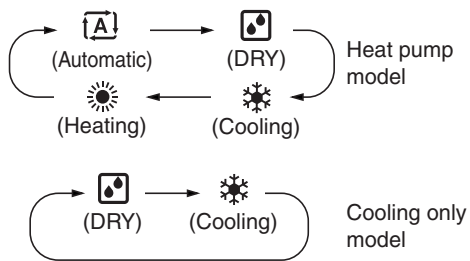

- The system does not have the FAN mode.

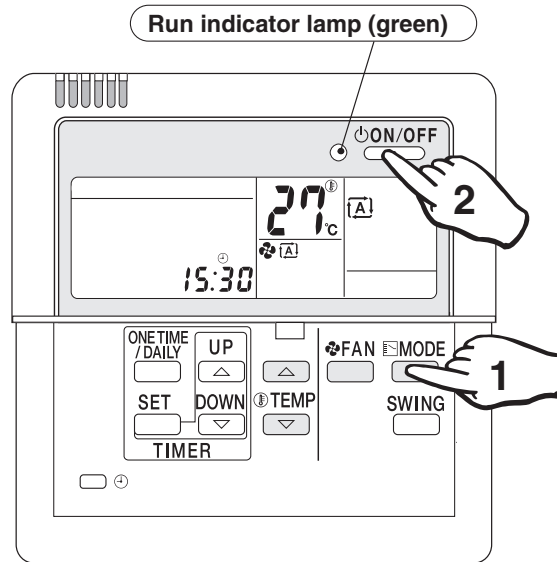

**2** Press .

The run indicator lamp lights up.

## ■ To stop the operation:

Press  again.

The run indicator lamp goes out.

### Automatic operation

- In Automatic, the temperature setting and operation mode (DRY, Cooling or Heating) are automatically selected according to the room temperature and outdoor temperature at the time of starting operation.

### DRY operation









- In this mode, humidity is removed from the air.



### Note

- While running in the DRY mode, you may feel cool or warm air from the air outlet. In this case, readjust the airflow direction with the vertical airflow direction louvers. (except Duct Connected type)

### ■ To adjust the temperature and airflow rate:

| Setting to be adjusted / Operation mode   | Automatic  | Cooling | Heating | DRY                              |
|---|--|---------|---------|----------------------------------|
| <br>Ⓜ TEMP<br><br>(Temperature) | Temperature is adjustable.<br>Recommended temperature<br>Cooling : 26°C-28°C (79°F~82°F)<br>Heating : 20°C-22°C (68°F~72°F)  |         |         | Temperature cannot be adjusted.  |
| <br><br>(Airflow rate)          | Five levels of airflow rate setting from "  " to "  " plus "  " are available.<br> |         |         | Airflow rate cannot be adjusted. |

- When the unit runs in the cooling or heating mode at a low airflow rate, the cooling or heating effect may be insufficient.

### ■ To adjust the airflow direction:

(  page 9)

#### Heating operation

- Since the heating operation is performed by taking the heat from outdoor into the room, the heating capacity decreases as the outdoor temperature lowers. If the room is not heated sufficiently, it is recommended to use other heating appliance at the same time.
- Since the air conditioner heats the whole room by circulating hot air, it takes some time to heat the entire room completely.
- If the outdoor unit gets frosted during heating operation, the heating capacity is decreased. In this case, the unit starts defrosting operation.
- No hot air comes out of the indoor unit during defrosting operation.

# Adjusting Airflow Direction

Adjust the airflow direction for maximum comfort.

## To adjust the Airflow Direction

- 1 Press  during operation.
  - Each time the button is pressed, the airflow direction louvers change their movement.

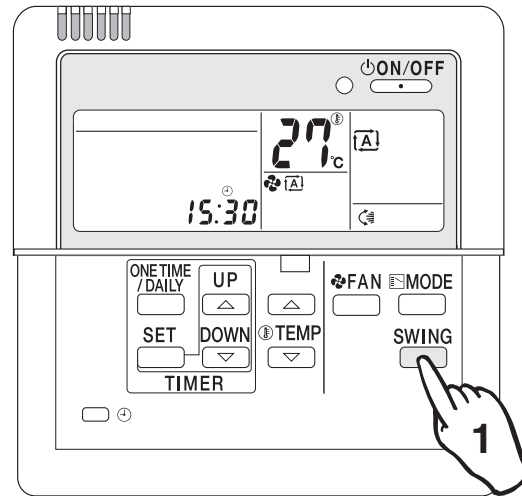

## ■ Wall Mounted Types (without horizontal swing function)

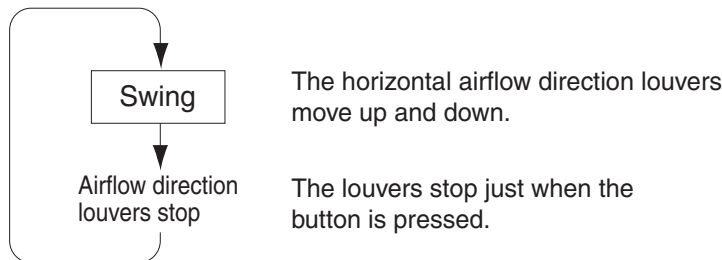

### Adjustment of horizontal airflow direction

- The automatic moving range of the horizontal airflow direction louvers varies depending on the operation mode.



#### Notes

- In fixing the horizontal airflow direction, keep the horizontal airflow direction louvers tilted downward in the heating mode, and keep them nearly horizontal level in the cooling or DRY mode. This will enhance the cooling and heating effect.
- On the air conditioners with vertical and horizontal swing function, be sure to adjust the airflow directions using the remote controller. Do not forcibly adjust louvers by hand or a malfunction may occur.

## ■ Wall Mounted Type (with horizontal swing function)

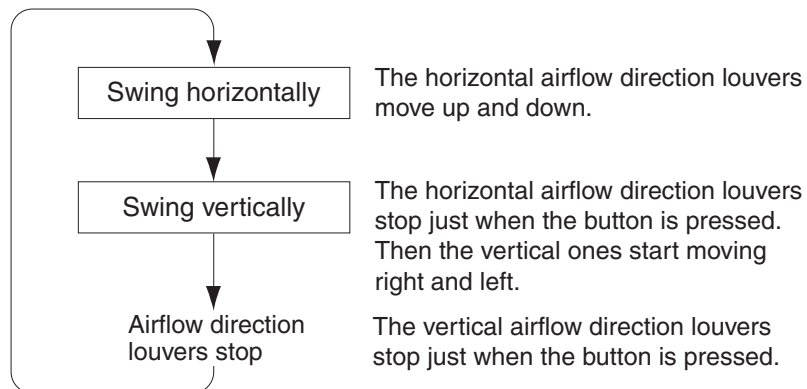

- The vertical and horizontal louvers cannot move at the same time.

## ■ Duct Connected Type (without swing function)

This function cannot be used.



### Note

- The operating procedure and remote controller display are different depending on the indoor unit being connected. Read **How to Adjust the Airflow Direction** in the air conditioner's Operation Manual.

# Timer Operation

The Timer Operation feature automatically turns off operation when you go to sleep and turns it back on when you wake up.

Use the DAILY Timer mode on weekdays, and the ONE TIME timer mode on weekends.

## ■ To select the ONE TIME timer mode:

1 Press  to select the ONE TIME timer mode.

- Each time the button is pressed, the modes change as follows.

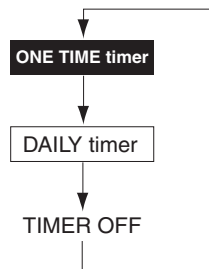

The timer lamp lights up.

## ■ To cancel the timer settings:

1 Press  to clear the timer settings.

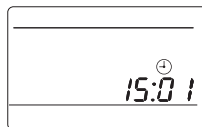

The **ONE TIME** or **DAILY TIMER** disappears from the display, and the timer lamp goes out too.

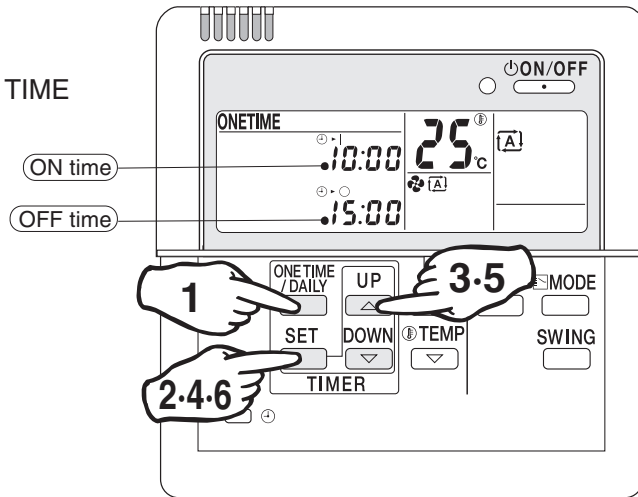

(Timer settings displayed)



### Notes

- Even when the timer has been off, its programmed settings are still in memory.
- If the system has the timer control ON but you start and stop it manually using the ON/OFF button before the designated ON time, the system will restart again at the programmed ON time.

### Precautions in setting the timer

- Before starting the timer operation, make sure the current time is correct. If not, set the clock correctly. (☞ page 5)
- In making time settings, --:-- is displayed to make it easy to disable the timer too.
- If one minute has passed before making any timer setting, the previous timer settings are reintroduced and the timer is on standby.  
In this case, use the  (time setting) button and make your desired timer settings.

### Timer operation

- When the ON timer is programmed, the system starts one hour (maximum) earlier so that the temperature set by the remote controller is reached just in time.
- When the ONE TIME timer is programmed, the current time is no longer displayed.

■ ONE TIME timer

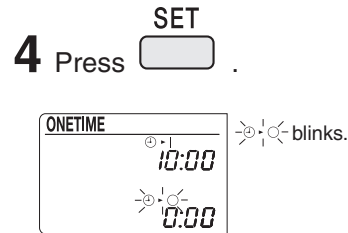
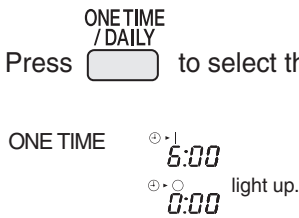

Once the timer has been activated and then deactivated, it is in the OFF mode. The ON or OFF timers can be programmed.

1 Press  to select the ONE TIME timer. 4 Press .



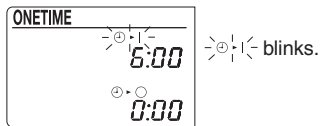

2 Press .

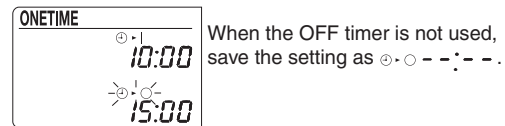

5 Press   to make the OFF timer setting.



3 Press   to make the ON timer setting.

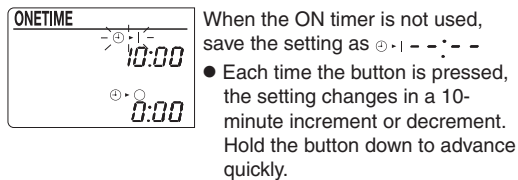

6 Press  .  
(The ONE TIME timer is now programmed.)

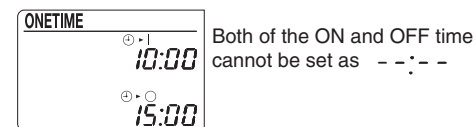

Example of display with the ONE TIME timer programmed

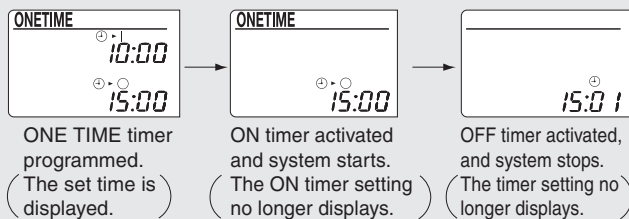

Notes

- In the following cases, reset the clock (the time setting is kept in the memory).
  - The circuit breaker has been activated.
  - The power fails.

# Timer Operation

## ■ To select the DAILY timer mode:

1 Press  to select the DAILY timer mode.

- Each time the button is pressed, the modes change as follows.

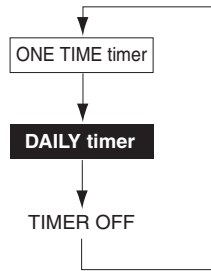

The timer lamp lights up.

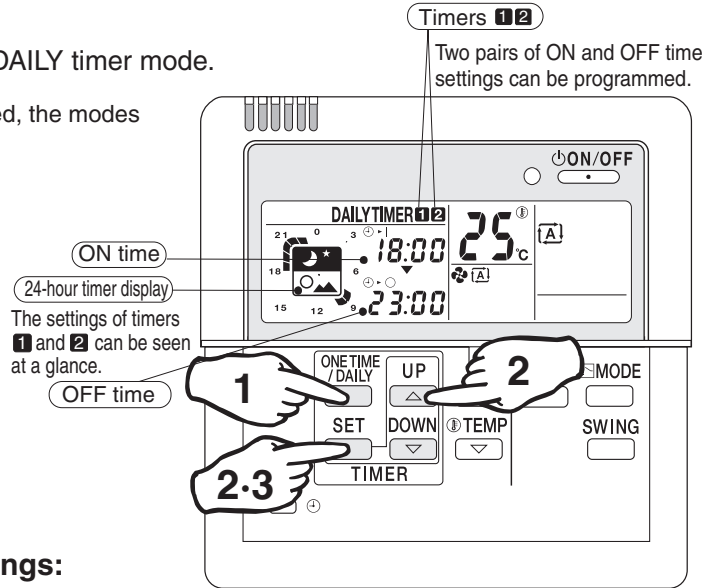

(Timer settings displayed)

## ■ To cancel the timer settings:

1 Press  to clear the timer settings.

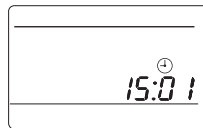

The **ONE TIME** or **DAILY TIMER**, and the timer lamp are no longer displayed.

### Example of display with DAILY timer programmed

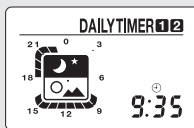

Timers **1** and **2** programmed.

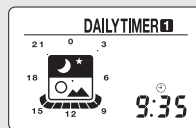

Timer **1** alone programmed.





### Note

- The system starts and stops repeatedly until the DAILY timer is set off. Before you leave home for a long time, set the DAILY timer off.







**■ DAILY timer**

After programming, the system starts and stops each day at the preset times. Two pairs of time settings can be programmed.

(Example: 8:00 ~ 10:00, and 18:00 ~ 23:00)

**1** Press  to select the DAILY timer.  lights up. DAILY timer indication appears.

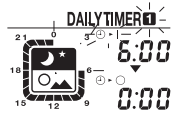
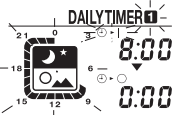
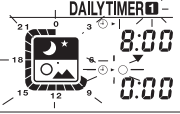
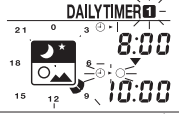
**2** Make the ON and OFF time settings. ● Take the steps from ① to ⑧.  
Program example: 8:00 ~ 10:00, and 18:00 ~ 23:00

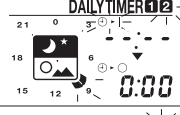
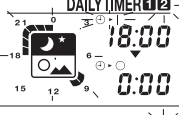
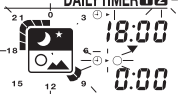
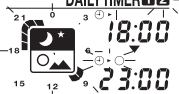
| Settings  |  | Procedure | Press  | Press  to make the timer setting.<br> |   |
|---|--|-----------|---|---|---|
|   | ON time setting<br>● When the timer <b>1</b> is not used, save the setting as ①- - - - | ①         |        | ②   |    |
|   | OFF time setting   | ③         |       | ④   |   |
|  | ON time setting<br>● When the timer <b>2</b> is not used, save the setting as ②- - - - | ⑤         |      | ⑥   |  |
|   | OFF time setting   | ⑦         |      | ⑧   |  |

**3** Press  . The DAILY timer is now programmed.



**Note**

- If the following appears on the display, the timer must be reprogrammed.

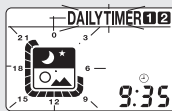

The 24-hour timer display is blinking.

This means that Timers **1** and **2** are programmed for the same time settings. New time settings must be made.

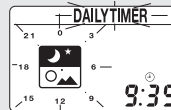

The 24-hour timer display is blinking.

This means that the timer has not been programmed yet.



# Cleaning

## Cleaning the remote controller

- Wipe it clean with soft, dry cloth.  
Do not use any water hotter than 40°C (104°F), or volatile liquids such as benzene, gasoline and thinner, polishing powder, or anything hard such as a scrub brush.

## When the unit is not used for a long time

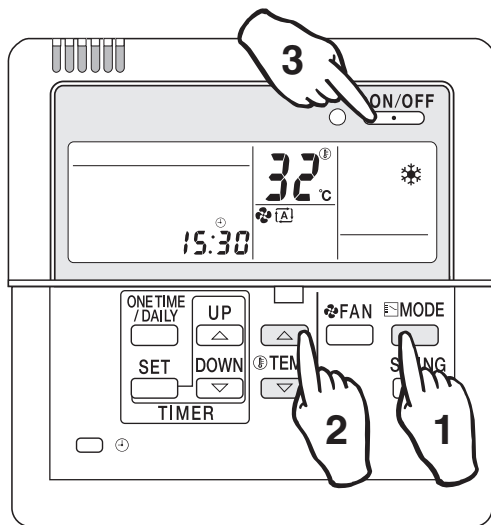

- ① On a sunny day, keep the system running for half a day in the FAN mode to dry it up inside.

### FAN mode

- 1 Press to select the cooling mode.
  - 2 Press to adjust the set temperature to 32°C (90°F).
  - 3 Press .
    - The airflow rate remains the same, and is not adjustable.
    - Run the system when the room temperature is below 28°C (82°F).
- ② Finally turn off the circuit breaker dedicated for the room air conditioner.
  - ③ Clean the air filter and place it back into position.

## 13.3 <KRP413AB1S> Wiring Adaptor for Timer Clock / Remote Controller

### Safety Precautions

- Read these safety precautions carefully before installing the unit, and be sure to install the unit properly.
- This manual classifies precautions to the user into the following two categories. These warnings and cautions are for your safety. Follow them.

|                  |   |
|------------------|---|
| <b>⚠ WARNING</b> | Indicates a potentially hazardous situation which, if not avoided, could result in death or serious injury.   |
| <b>⚠ CAUTION</b> | Indicates a potentially hazardous situation which, if not avoided, may result in minor or moderate injury. It may also be used to alert against unsafe practices. |

- After installation is complete, test the unit to confirm that it is working properly, and instruct the owner its proper use.

### ⚠ WARNING

- Installation should be left to the dealer from whom you purchased the unit, or another qualified professionals.
- Install the unit securely according to the installation manual. Faulty installation may lead to electric shock or fire.
- Be sure to use the supplied or specified parts. Using other parts may lead to electric shock or fire.
- Install the unit securely in a location that will support its weight. If installed in a poor location or improperly installed, the unit may not work as intended.
- For electrical work, follow local electric standards and the installation manual. Faulty installation may lead to fire or electric shock.
- Do not bundle the power cord, or attempt to extend it by splicing it with another cord or by using an extension cord. Do not place any other load on the power circuit used for the unit. Improper wiring may lead to electric shock, heat generation or fire.
- Use dedicated wiring for all electrical connections, and be sure to arrange the wiring so that force applied to the wiring will not damage the terminals. Poor wiring or installation may cause electric shock, heat generation or fire.

### ⚠ CAUTION

- Before installation, unplug the air conditioner to ensure safety. Failure to do so may cause electric shock.
- Static electricity may damage electric components. Before connecting cables and communication lines, and operating the switches, be sure to discharge any electrical charge from your body (by, for example, touching the ground line)
- Do not install the unit in a location where it may be exposed to flammable gases. If gas leaks and build up around the unit, it may catch fire.
- Do not place the wiring close to the power cord, inter-unit cable, or pipes which generate noise. Treat the wiring with care.

### 1. Functions and Features

- On/Off setting
- Switching between Instantaneous Contact/Normal Contact
- Connection with five-room central controller (KRC72 for oversea model)
- Connection with fan coil remote controller
- Automatic reset after power failure
- Output of normal operation signals/malfunction signals

### 2. Field Wiring

For interconnecting wiring, use Daikin KDC100A12 cable (not supplied) or other similar cable. Use a vinyl-covered wire or cable with four conductors each with a thickness of 0.2 to 1.25 mm<sup>2</sup>.

#### ■ Optional cable KDC100A12 (without connectors)

Specifications: 0.2 mm<sup>2</sup> × 4 core (sheathed)  
 Outer diameter: φ5.3  
 Length: 100 m  
 Colour: Grey

Note : Keep any wiring for the control unit away from the power cord to prevent electrical noise.

## Installation ①

### 1 Installation diagram

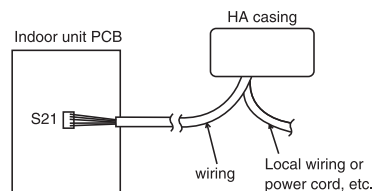

### 2 Components

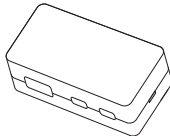
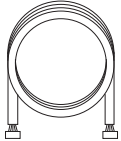
|   |  |
|---|--|
| <b>① HA casing ASSY</b><br>(Remote Control PCB is attached in the HA casing.)<br> | <b>② Wiring (approx. 0.8 m)</b><br> |
| <b>③ Accessories</b><br>Binding band (6 pcs.)<br>• Screws for attaching to the wall (3 pcs.)  |  |
| <b>④ Installation manual</b>  |  |

## Installation ②

### Attaching HA Case ASSY

- Use the 3 supplied screws to attach the HA casing ASSY.

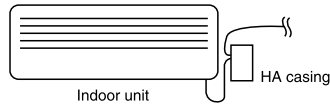

Install the HA casing ASSY as close to the indoor unit as possible.

#### ① Removal of upper HA casing

- (1) Insert a flat-blade screwdriver into the groove between the upper and lower HA casings.

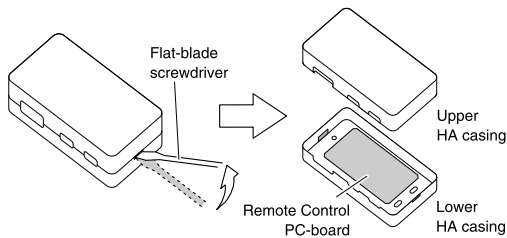

- (2) Lift the handle of the screwdriver upward.

- (2) Mount and secure the lower HA casing directly on the wall with the provided screws inserted into the screw holes (a round hole and two ellipse holes) of the casing.

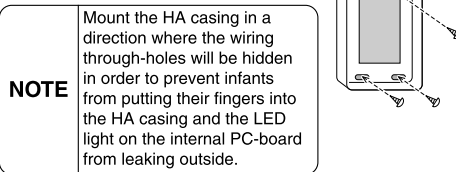

- (3) After connecting the cables (refer to the following sections), replace the case front. Be careful not to damage the wiring in the case.

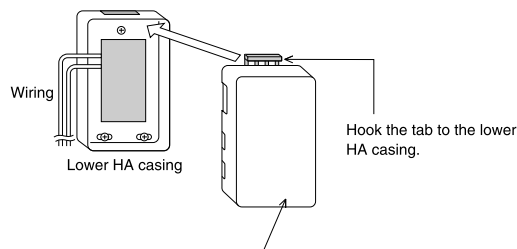

Press the lower part of the upper HA casing and press fit it onto the lower HA casing.  
Press the upper HA casing precisely until a clicking sound is heard.

## Wiring ①

### 1. Wiring

- ① Connect one end of the wiring to connector S21 of the PCB in the indoor unit.
- ② Connect the other end of the wiring to connector S6 of the Remote Control PCB.
- ③ Connect field wiring according to the functions assigned to each connection terminal of the Remote Control PCB.
- ④ Secure all wires.

#### 1 Securing wires in the HA casing ASSY

##### ① Connection of wiring

Connect the wiring to the connector terminals.

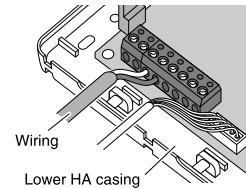

##### ② Fixation of wiring

- (1) Insert the provided binding band under the pillar of the HA casing and secure the covers of the wiring with the binding band.

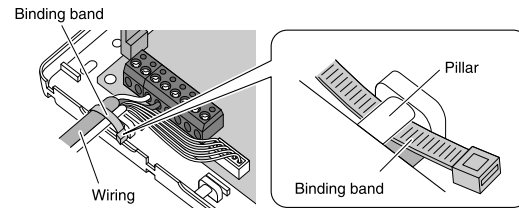

- (2) Insert the second binding band into the groove on the side of the HA casing and fix the wiring securely so that the wiring will not be disconnected.

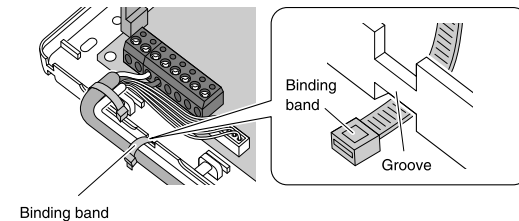

#### A large number of wires

Make a slit with an appropriate tool, such as a cutter knife, on the thin part of the upper HA casing along the frame. Then cut the part with an appropriate tool, such as a pair of nippers.

(NOTE) Cut off only the thin part required for wiring.

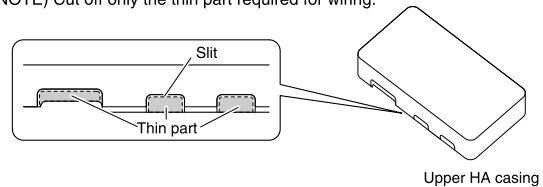

#### 2 Securing wires in the indoor unit

- The method for securing wire varies depending on the model of the air conditioner. See your air conditioner installation manual for details.

## Wiring ②

### 2. Automatic Reset After Power Failure

- This PCB stores the following data in the event of a power failure (the storage period is limitless).
  - ① On/Off (see Note 1)
  - ② Operation modes (see Note 2)
  - ③ Temperature setting
  - ④ Air flow rate
  - ⑤ On/Off status of remote controller
- (Note 1 When SW1-2 is in Off mode, the unit will not be activated.)
- (Note 2 The following settings apply to the models below.)

| Mode before the power outage                                     | COOLING     | HEATING       |
|--|-------------|---------------|
| Room air conditioner   |             |               |
| Models with Humid heating and Reheating dehumidifying functions. | DRY COOLING | HUMID HEATING |
| Models with Reheating dehumidifying function.                    |             | HEATING       |

(Note 3 Not all settings will be saved (e.g., humidity or swing settings will not be saved)).

### 3. Monitor Signal Output (normal operation and malfunction)

- Maximum length of the wiring is 100 m. No external power supply is required.

#### 1 Monitor signal output for LED

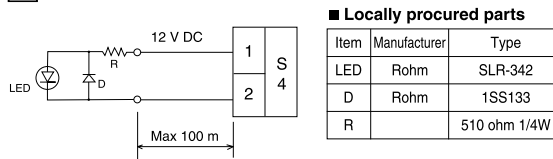

#### 2 Monitor signal output (normal operation and malfunction) using external relay contacts

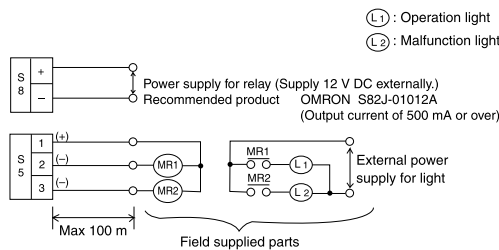

#### Field procured parts (Recommended external relay contacts)

| Manufacturer | Type     | Coil rated voltage | Coil resistance |
|--------------|----------|--------------------|-----------------|
| Omron        | MY relay | 12 V DC            | 160 ohm ± 10%   |
| Panasonic    | HC relay | 12 V DC            | 160 ohm ± 10%   |

### 4. Connection with Remote Controller

Example connections with three kinds of remote controllers are shown below. Note: These connections cannot be used in combination.

#### 1 Remote control with switch (field supply)

- Set SW1-1 to Off and select Operation Mode 1.



##### <Instantaneous Contact>

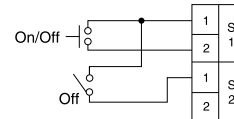

- The remote controller most recently used (local or air conditioner) takes precedence.
- Use a remote controller with a pulse width of 100 msec or more.

##### <Normal Contact>

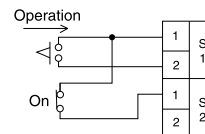

- Power On/Off cannot be controlled from the unit's remote controller. (Three beeps for signal reception will be heard continuously when the wireless remote controller is operated.)
- When power is restored after a power failure in this mode, On or Off is determined according to the current settings of the remote controller.

#### 2 Five-room central controller (KRC72)

- Set SW1-1 to Off and select Operation Mode 1.
- The remote controller most recently used takes precedence.

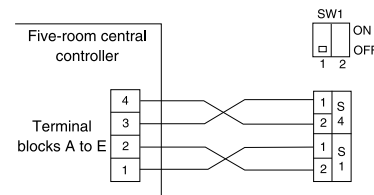

#### 3 Fan coil remote controller

- Set SW1-1 to On and select Operation Mode 2.
- Most settings (power On/Off, air flow rate, mode change) cannot be made using the air conditioner's remote controller.
- When power is restored after a power failure in this mode, On or Off is determined according to the current settings of the remote controller.
- When the Cooling/Heating mode is changed, use the air conditioner's remote controller to adjust the temperature.

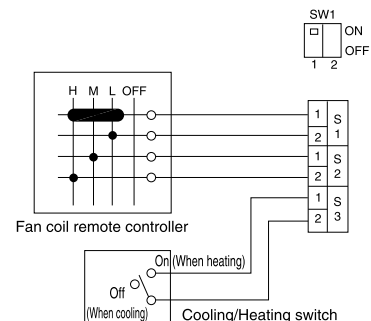

## Test Operation and Confirmation

### 1. When the System is Not Working

- Is the air conditioner working properly?
- Are the connectors of the wiring properly connected?
- Are the remote controller and field wiring properly connected?
- Are all switch settings correct?
- If there is nothing apparently wrong, conduct a diagnostic check using the following procedure.

■ Diagnostic check

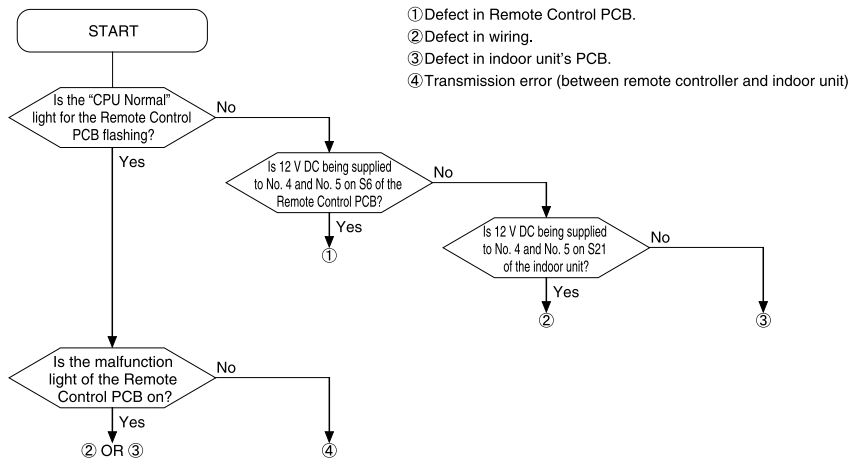

### 2. Switch Settings and Connection Terminals

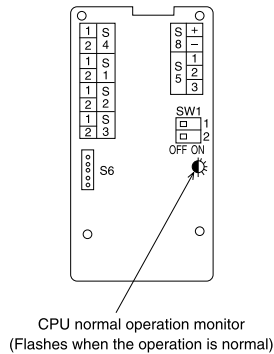

|                |   |  |  |                    |   |
|----------------|---|--|--|--------------------|---|
| SW1-1          | Selecting the operation mode                                  | OFF  | Operation mode 1 (Used with the exception of fan coil remote controller settings)                          |                    |   |
|                |   | ON   | Operation mode 2 (Used with fan coil remote controller settings)   |                    |   |
| SW1-2          | Selecting On/Off when power is restored after a power failure | OFF  | Always Off   |                    |   |
|                |   | ON   | Off if operation was in Off mode before power failure; On if operation was in On mode before power failure |                    |   |
| S1<br>S2<br>S3 | SW1-1: OFF<br>(Operation mode 1)                              | Instantaneous contact                                      |  | Normal contact     |   |
|                |   | S1 (1) - S2 (1)  | OPEN   | CLOSE              |   |
|                |   | S1 (1) - S1 (2)  | Pulse input<br>On/Off switching  |                    | OPEN, Not activated<br>CLOSE, Activated |
|                |   | S2 (2), S3   | Not used   |                    |   |
|                |   | S1, S2 OPEN  | Not activated  |                    |   |
|                | SW1-1: ON<br>(Operation mode 2)                               | S1 (1) - S1 (2) CLOSE                                      |  | On, airflow: L tap |   |
|                |   | S1 (1) - S2 (1) CLOSE                                      |  | On, airflow: M tap |   |
|                |   | S1 (1) - S2 (2) CLOSE                                      |  | On, airflow: H tap |   |
|                |   | S3 (With the remote controller only)                       | OPEN   | Cooling            |   |
|                |   |  | CLOSE  | Heating            |   |
| S4             | (1) - (2)   | Voltage on (12 V DC), normal operation light output        |  |                    |   |
| S5             | (1) - (2)   | Normal operation light output (power for light required)   |  |                    |   |
|                | (1) - (3)   | Malfunction light output (power for light required)        |  |                    |   |
| S6 connector   |   | Connect with connector S21 on the PCB of the indoor unit   |  |                    |   |
| S8             | (+) - (-)   | Relay 12 V DC power supply terminal (Field supplied parts) |  |                    |   |

### 13.4 <KRP928BB2S> Interface Adaptor for DIII-NET (Residential Air Conditioner)

#### Safety Precautions

- Read these Safety Precautions carefully to ensure correct installation. This manual classifies precautions into WARNING and CAUTION.
- WARNING** : Indicates a potentially hazardous situation which, if not avoided, could result in death or serious injury.
- CAUTION** : Indicates a potentially hazardous situation which, if not avoided, may result in minor or moderate injury. It may also be used to alert against unsafe practices.

Be sure to follow all the precautions below ; they are all important for ensuring safety.

**WARNING**

- Installation should be left to the dealer or another qualified professional.**  
Improper installation by yourself may cause malfunction, electrical shock, or fire.
- Install the set according to the instructions given in this manual.**  
Incomplete or improper installation may cause malfunction, electrical shock, or fire.
- Be sure to use the standard attachments or the genuine parts.**  
Use of other parts may cause malfunction, electrical shock, or fire.
- Disconnect power to the connected equipment before starting installation.**  
Failure to do so may cause malfunction, electrical shock, or fire.

**CAUTION**

- A ground leakage circuit breaker should be installed.**  
If the breaker is not installed, electrical shock may occur.
- Do not install the set in a location where there is danger of exposure to inflammable gas.**  
Gas accumulated around the unit at the worst may cause fire.
- To prevent damage due to electrostatic discharge, touch your hand to a nearby metal object (doorknob, aluminum sash, etc.) to discharge static electricity from your body before touching this kit.**  
Static electricity can damage this kit.
- Lay this cable separately from other power cables to avoid external electrical noises.**

- After installation is complete, test the operation of the PCB set to check for problems, and explain how to use the set to the end-user.

#### 1. Overview, Features and Compatible Models

This kit is the interface required when connecting the central controller and a Daikin Room Air Conditioner. Use of the central controller makes it possible to perform the following monitoring and operations. It is compatible with room air conditioners which have an HA connector S21.

- Run / stop for the central controller and wired remote controller, operating mode selection, and temperature can be set.
- The operating status, any errors, and the content of those errors can be monitored from the central controller and wired remote controller.
- Run / stop for the central controller and wireless remote controller, operating mode selection, and the temperature setting can be limited by the central controller.
- Zone control can be performed from the central controller.
- The unit can remember the operating status of the air conditioner before a power outage and then start operating in the same status when the power comes back on.
- Card keys, operating control panels, and other constant / instantaneous connection-compatible equipment can be connected.
- The Operating / error signals can be read.
- HA JEM-A-compatible equipment can be connected.
- The indoor temperature can be monitored from the Ve-up controller.

#### Precaution

- When reading the Operating / error signals, a separate external power source (12 V DC) is needed.
- A separate timer power source (16 V DC) is needed when using the schedule timer independently, and not in conjunction with other central controllers.
- The range of temperatures that can be set from the central controller is 18°C to 32°C in cooling and 14°C to 28°C in heating.
- Fan operation cannot be selected from the central controller or wired remote controller.
- Group control (i.e., control of multiple indoor units with a single remote controller) is not available.
- Monitoring is not available of the thermo status, compressor operating status, indoor fan operating status, electric heater, or humidifier operating status.
- Forced thermo off, filter sign display and reset, fan direction and speed settings, air conditioning fee management, energy savings instructions, low-noise instructions, and demand instructions cannot be made.

#### 2. Component Parts

This kit includes the following components. Check to ensure that none of these are missing.

| Parts  | Q'ty | Parts                           | Q'ty  |
|--|------|---------------------------------|-------|
| Kit assy<br>PCB is in the housing.   | 1    | Connection harness (about 1.6m) | 1set  |
|  |      | Mounting screws                 | 3pcs. |
|  |      | Binding band                    | 6pc.  |
|  |      | Installation manual             | 2set  |

#### 3. Names of Parts and Electric Wiring

##### <Wiring procedure>

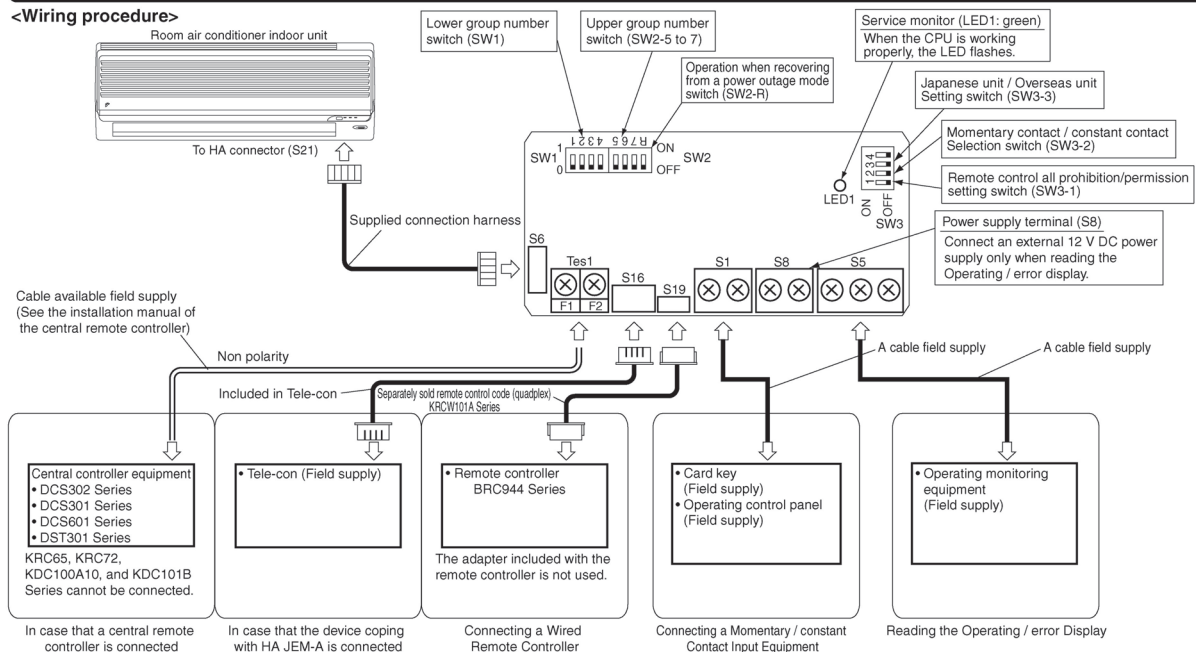

### 4. Switch Settings

**NOTE** Turn the power on after all the switches have been set. Settings made while the power is on are invalid.

Open the kit's case and set the switches on the circuit board.  
 (1) For Overseas / Japanese unit setting (SW3-3)  
 Room air conditioners, different methods are used for setting the temperature in automatic mode, so this switch needs to be set.

| Destination | SW3-3 setting         | What Happens   |
|-------------|-----------------------|--|
| Japan       | OFF (Factory setting) | • "Automatic" operation is not available from the central controller. When using "automatic" operation using the wireless remote controller, the central controller displays automatic cooling (heating) and 25°C. Even if the temperature is changed, it will return to 25°C after a while. |
| Overseas    | ON                    | • "Automatic" operation is available from the central controller.  |

(2) Group number settings (SW1 and SW2-5 to SW2-7)  
 Set these when using the central controller. (Set to the  side.) Do not set more than one unit to the same number.  
 Use SW2-R for (3) Settings when recovering from a power outage.

However, these settings do not need to be made when using the schedule timer independently.  
 (The settings are needed when used in conjunction with another DCS Series central controller.)  
 In this case, the schedule timer performs an auto address after the power is turned on, so new group numbers are automatically set. Settings made using the switches will be overwritten.

| Upper group NO. | Knob position | 1— | 2— | 3— | 4— | 5— | 6— | 7— | 8— |
|-----------------|---------------|----|----|----|----|----|----|----|----|
| SW2 setting     | OFF           |    |    |    |    |    |    |    |    |
| Lower group NO. |               | 00 | 01 | 02 | 03 | 04 | 05 | 06 | 07 |
| SW1 setting     | OFF           |    |    |    |    |    |    |    |    |
| Lower group NO. |               | 08 | 09 | 10 | 11 | 12 | 13 | 14 | 15 |
| SW1 setting     | OFF           |    |    |    |    |    |    |    |    |

NOTE also that a separate timer power source is needed when using the schedule timer independently.  
 Power source specs: 16 V DC, +10%, -15%, 200mA.  
 Recommended power source: Omron S82J-01015A. (Should be used with the output voltage adjusted to the center, 16 V DC.)

(3) Settings when recovering from a power outage (SW2-R)  
 This selects whether to restart operation when the power comes back on after a power outage occurred during operation. This setting is given priority in cases where the indoor unit has an auto start ON / OFF jumper. Note also that regardless of whether switch SW2-R is on or off, the operating mode (NOTE), set temperature, fan direction and speed settings, and remote control prohibition status are stored.

| SW2-R setting         | What Happens  |
|-----------------------|---|
| OFF (Factory setting) | Stops after recovering from a power outage  |
| ON                    | Stops if the unit was stopped before the power outage and runs if it was running. |

(NOTE) The following settings apply to the models below.

| Mode before the power outage                                     | COOLING     | HEATING       |
|--|-------------|---------------|
| Room air conditioner   |             |               |
| Models with Humid heating and Reheating dehumidifying functions. | DRY COOLING | HUMID HEATING |
| Models with Reheating dehumidifying function.                    |             | HEATING       |

(4) Contact input function settings (SW3-1 to SW3-2)  
 When using contact input (S1), choose one of the following functions.

| S1 operating mode                               | SW3-1 setting | SW3-2 setting | What Happens   | Control mode  |
|---|---------------|---------------|--|---|
| Instantaneous contact input (factory setting)   | OFF           | OFF           | The operating status of the air conditioner is reversed by an instantaneous input of 100 msec or more. | Last command priority   |
| Constant contact input                          | OFF           | ON            | Contact - Open to close: air condition runs. Close to open: air conditioner is stopped (NOTE 1).       | ON / OFF control is rejected (operate / stop / timer prohibition) (NOTE 2).       |
| Remote control all prohibition/permission input | ON            | Invalid       | Contact - Open to close: air condition stops. Close to open: no change in operating status.            | All remote controller actions are prohibited when the contact is closed. (NOTE 3) |

NOTE1: Since central equipment and HA JEM-A-compatible equipment both use last command priority, the contact status and operating status of the air conditioner might not match sometimes.  
 Example: If the unit is run from the central controller while the air conditioner is stopped with an open contact, the contact will be open and the unit will be running.

NOTE2: Operating mode and fan direction and speed settings can be changed.  
 NOTE3: If the contact is closed while the ON timer is set, as the power ON timer function is still operating, the operation starts at the time specified by the timer. To prevent operation of the power ON timer, use of the (KRP413AB1S) remote control PC-board set is recommended. However, note that it cannot be used in tandem with the central controller.

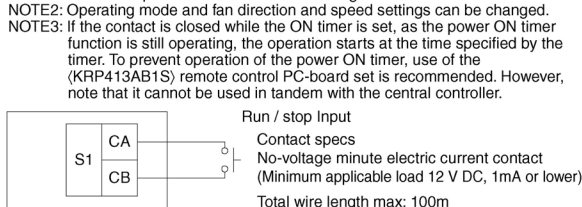

### 5. Control Codes

When using a central remote controller, the operating codes can be used to limit operation from wireless remote controllers. Three beeps for signal reception will be heard continuously when the wireless remote controller is operated while in central control.  
 ○ : permitted; × : prohibited

| S1 operating mode                            | Control mode                 | Control code | Operations from the remote controller |      |                            |                             | Operations from the central controller |      |                            |                             | Operations from central controller, contact input and HA JEM-A input |  |
|--|------------------------------|--------------|---------------------------------------|------|----------------------------|-----------------------------|--|------|----------------------------|-----------------------------|--|--|
|  |                              |              | Run / timer                           | Stop | Operating mode temperature | Fan direction and fan speed | Run / timer                            | Stop | Operating mode temperature | Fan direction and fan speed |  |  |
| Instantaneous contact mode                   | ON / OFF control is rejected | 0,1,3        | ×                                     | ×    | ○                          |                             |  |      |                            |                             |  |  |
|  | 10,11                        | ×            | ×                                     | ×    |                            |                             |  |      |                            |                             |  |  |
|  | Only OFF control is accepted | 2            | ×                                     | ○    | ×                          |                             |  |      |                            |                             |  |  |
|  | 12-19                        | ×            | ○                                     | ×    |                            |                             |  |      |                            |                             |  |  |
|  | Central priority             | 4            | ○                                     | ○    | ○                          |                             |  |      |                            |                             |  |  |
| Constant contact mode                        | 5                            | ○            | ○                                     | ○    |                            |                             |  |      |                            |                             |  |  |
|  | Last command priority        | 6,7          | ○                                     | ○    | ○                          |                             |  |      |                            |                             |  |  |
|  | 8                            | ○*           | ○*                                    | ○*   |                            |                             |  |      |                            |                             |  |  |
| All remote controller actions are prohibited | 9                            | ○*           | ○*                                    | ○*   |                            |                             |  |      |                            |                             |  |  |
|  | 2,10-19                      |              |                                       |      |                            |                             |  |      |                            |                             |  |  |
|  | 0,1,3,5-7                    |              |                                       |      |                            |                             |  |      |                            |                             |  |  |
|  | 4                            | ×            | ×                                     | ×    |                            |                             |  |      |                            |                             |  |  |
| All remote controller actions are prohibited | 8                            |              |                                       |      |                            |                             |  |      |                            |                             |  |  |
|  | 9                            |              |                                       |      |                            |                             |  |      |                            |                             |  |  |

\*Only during timer operation  
 The remote controller permission / prohibition settings using the Ve-up controller are as follows.  
 ○ : permitted; × : prohibited

| S1 pin operating mode      | Ve-up controller settings                    |                       |                        | Operations from the remote controller |      |                            |                             | Operations from central controller, contact input and HA JEM-A input |
|----------------------------|--|-----------------------|------------------------|---------------------------------------|------|----------------------------|-----------------------------|--|
|                            | Start / stop                                 | Change operating mode | Change set temperature | Run / timer                           | Stop | Operating mode temperature | Fan direction and fan speed |  |
| Instantaneous contact mode | ON / OFF control is rejected                 | permitted             | permitted/prohibited   |                                       | ×    | ×                          | ○                           |  |
|                            |  | prohibited            | permitted/prohibited   | ×                                     | ×    | ×                          |                             |  |
| Constant contact mode      | Only OFF control is accepted                 | permitted             | permitted/prohibited   | ×                                     | ×    | ○                          |                             |  |
|                            |  | prohibited            | permitted/prohibited   | ×                                     | ×    | ×                          |                             |  |
| Instantaneous contact mode | Last command priority                        | permitted             | permitted/prohibited   | ○                                     | ○    | ○                          |                             |  |
|                            |  | prohibited            | permitted/prohibited   | ×                                     | ×    | ×                          |                             |  |
| Constant contact mode      | All remote controller actions are prohibited | permitted             | permitted/prohibited   | ×                                     | ×    | ×                          |                             |  |
|                            |  | prohibited            | permitted/prohibited   | ×                                     | ×    | ×                          |                             |  |
| Does not affect settings   |  |                       |                        | ×                                     | ×    | ×                          | ×                           |  |

### 6. Read Operating / Error Display Signal

The Operating / error signals can be read from the contact output (S5).  
 Output specs

- M1: Turn MR 1 ON when the air conditioner is running.
- M2: Turn MR 2 when a communication error has occurred between the KRP928BB2S and the air conditioner, or MR 1 is ON and the unit has stopped after an error.
- MR 2 is not turned ON during a warning.

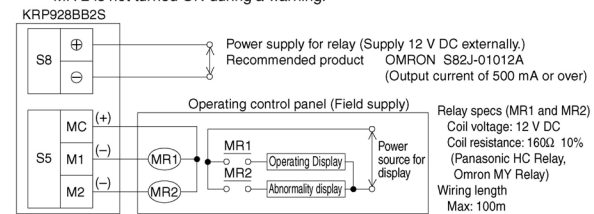

### 7. Combining Equipment

The central controller can be combined with the following devices.

|                               | Central Remote Controller | ON / OFF controller | Schedule timer | D-BIPS | Contact input | HA JEM-A-compatible equipment | Wired Remote Controller | Wireless Remote Controller |
|-------------------------------|---------------------------|---------------------|----------------|--------|---------------|-------------------------------|-------------------------|----------------------------|
| Central Remote Controller     | ○                         | ○                   | ○              | ○      | ○             | ○                             | ○                       | ○                          |
| ON / OFF controller           | ○                         | ○                   | ○              | ○      | ○             | ○                             | ○                       | ○                          |
| Schedule timer                | ○                         | ○                   | ×              | ×      | ○             | ○                             | ○                       | ○                          |
| D-BIPS                        | ○                         | ○                   | ×              | ×      | ○             | ○                             | ○                       | ○                          |
| Contact input                 | ○                         | ○                   | ○              | ○      | ×             | ○                             | ○                       | ○                          |
| HA JEM-A-compatible equipment | ○                         | ○                   | ○              | ○      | ○             | ×                             | ○                       | ○                          |
| Wired Remote Controller       | ○                         | ○                   | ○              | ○      | ○             | ○                             | ×                       | ×                          |
| Wireless Remote Controller    | ○                         | ○                   | ○              | ○      | ○             | ○                             | ×                       | ○                          |

**Connection to Remote Control PC-board**

**1. Removal of upper HA casing**

① Insert a flat-blade screwdriver into the groove between the upper and lower casings.

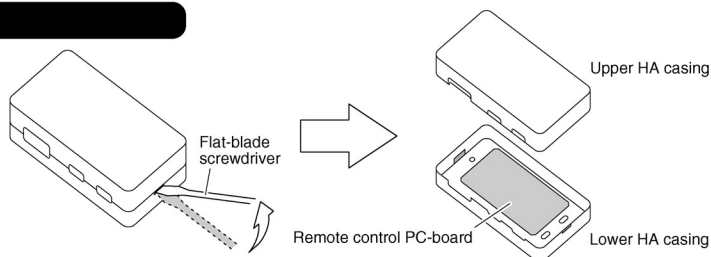

② Lift the handle of the screwdriver upward.

**2. Securing of lower HA casing**

Mount and secure the lower HA casing directly on the wall with the provided screws inserted into the screw holes (a round hole and two ellipse holes) of the casing.

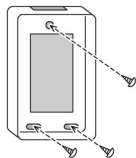

**NOTE**

Mount the HA casing in a direction where the wiring through-holes will be hidden in order to prevent infants from putting their fingers into the HA casing and the LED light on the internal PC board from leaking outside.

**3. Connection of wiring**

Connect the wiring to the connector terminals.

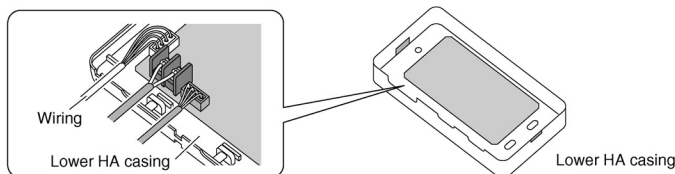

**4. Fixation of wiring**

① Insert the provided binding band under the pillar of the HA casing and secure the covers of the wiring with the binding band.

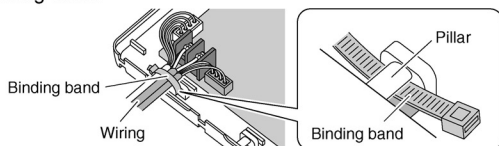

② Insert the second binding band into the groove on the side of the HA casing and fix the wiring securely so that the wiring will not be disconnected.

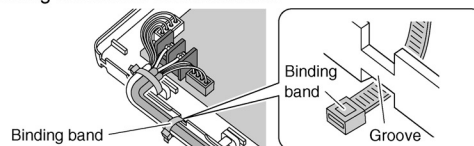

**A large number of wires**

Make a slit with an appropriate tool, such as a cutter knife, on the thin part of the upper HA casing along the frame. Then cut the part with an appropriate tool, such as a pair of nippers.

(NOTE) Cut off only the thin part required for wiring.

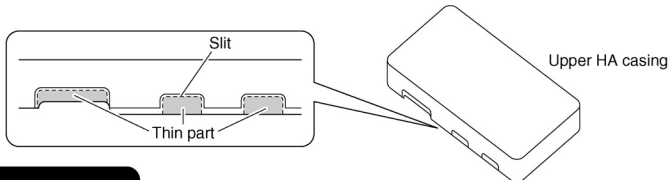

**5. Finishing**

Mount the upper HA casing to the original position.

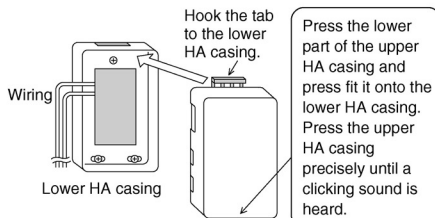

Press the lower part of the upper HA casing and press fit it onto the lower HA casing. Press the upper HA casing precisely until a clicking sound is heard.

**Information**

**When the contact input device (such as card keys) and central controller are used in tandem:**

Even when the operating mode of the S1 pin is set to prohibit all remote controller actions, run/stop operation from the central controller or HA JEM-A-compatible devices is possible. The operation also starts when the power ON timer of the indoor unit is up while all remote controller actions are prohibited. In this case, stop the operation from the central controller. For the compatible models of the (KRC944 series) slim remote controller, the operation can be prohibited by using the remote controller in tandem with the central controller.



3P248024-3B



## 13.5 <KPW5E112> Air Direction Adjustment Grille

### 1 Before Installation

**Components** Check before assembly that the following components are ready.

| Name     | Air direction adjustment grille   | Installation manual   |
|----------|---|---|
| Shape    |  <p>With setscrew (M5)</p> |  |
| Quantity | 1 piece   | 1 piece   |

### 2 Selection of Installation Location

Use the air direction adjustment grille for the outdoor unit if the installation place of the outdoor unit falls under the following conditions.

- Near the boundaries of the neighboring houses.
- Faces onto the street where pedestrians are directly exposed to the exhaust.
- Garden trees are directly exposed to the exhaust.

### 3 Required Installation Space

A minimum clearance of 4" (100mm) is required between the back of the outdoor unit and obstacles (such as walls).

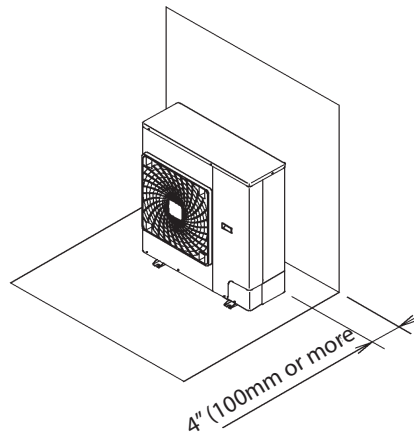

## 4 Installation of Air Direction Adjustment Grille

### ⚠ CAUTION

Mount the air direction adjustment grille overlapping the standard grille. It is dangerous to mount only the air direction adjustment grille because the fan rotating parts can come in contact with people's hands.

- (1) Remove 4 mounting screws on the standard grille.
- (2) Refer to the following illustrations and mount the standard grille and air direction adjustment grille according to the air blow-off direction.
  - Mount the air direction adjustment grille overlapping the standard grille and secure them with screws.
  - The mounting screws are attached to the air direction adjustment grille.
  - To let the air blow in the right and left, turn the air direction adjustment grille 90° counterclockwise and attach the air direction adjustment grille to the standard grille.

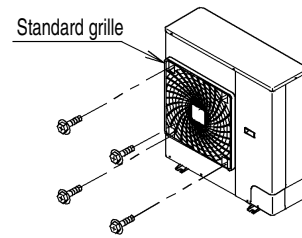

In the upper direction

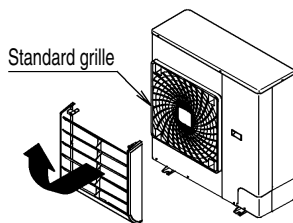

In the lower direction

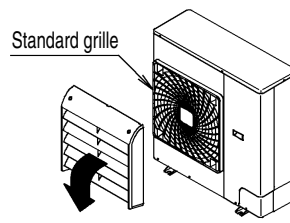

In the left direction

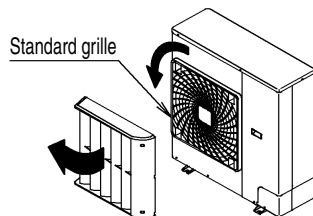

In the right direction

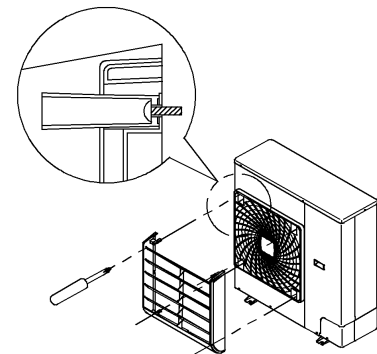
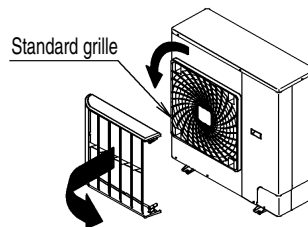
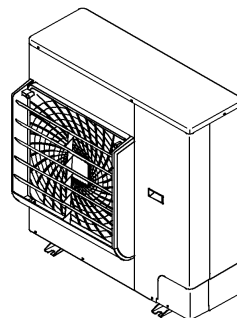

Illustration showing the completion of the air direction adjustment grille mounted (with the air blowing in the upper direction)



3P243204-1

### 13.6 <KKP945A4> Drain Plug

- Use this socket to connect a drain hose to dispose the drain from the outdoor unit.

#### ■ Before Installation

Check that this kit contains the following parts.

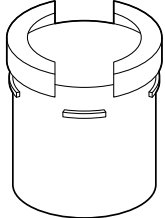
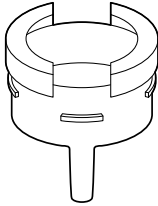
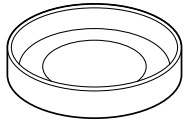
| Name     | ① Drain socket  | ② Drain cap   | ③ Drain receiver  |
|----------|---|---|---|
| Shape    |  |  |  |
| Quantity | 1 piece   | 2 pieces  | 3 pieces  |

#### ■ Installation Procedure

- 1 Check to make sure the outdoor unit drain hole is not hidden by the installation support or the floor.

Note) 1. If the drain holes of the outdoor unit are covered with the mounting bracket or the floor, raise the unit to provide the space of more than **4" (100mm)** under the leg of the outdoor unit.

2. Check the installation position with the outside drawing.

- 2 Insert drain receiver ③ onto drain socket ① and drain cap ② beyond 4 projections around drain socket.

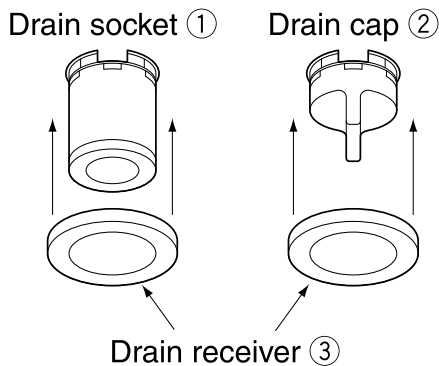

- 3 Insert drain socket ① into the drain hole A and drain caps ② into the drain hole B and C on the unit's bottom frame. After insertion, turn them about 40° clockwise.

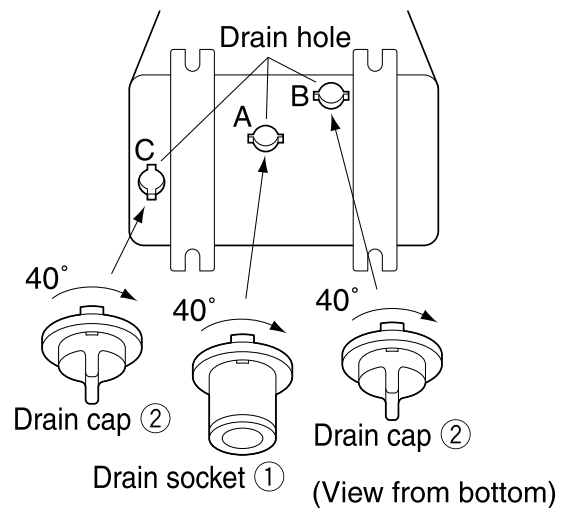

- 4 Connect vinyl hose on the market (**Internal diameter of 1" (25mm)**) to drain socket ① .

If the hose is too long and hangs down, fix it carefully to prevent the kinks.



- Daikin products are manufactured for export to numerous countries throughout the world. Prior to purchase, please confirm with your local authorized importer, distributor and/or retailer whether this product conforms to the applicable standards, and is suitable for use, in the region where the product will be used. This statement does not purport to exclude, restrict or modify the application of any local legislation.
- Ask a qualified installer or contractor to install this product. Do not try to install the product yourself. Improper installation can result in water or refrigerant leakage, electrical shock, fire or explosion.
- Use only those parts and accessories supplied or specified by Daikin. Ask a qualified installer or contractor to install those parts and accessories. Use of unauthorized parts and accessories or improper installation of parts and accessories can result in water or refrigerant leakage, electrical shock, fire or explosion.
- Read the User's Manual carefully before using this product. The User's Manual provides important safety instructions and warnings. Be sure to follow these instructions and warnings.

If you have any inquiries, please contact your local importer, distributor and/or retailer.



Daikin, Daikin AC Absolute Comfort, and its design, VRV, REFNET, and Quaternity are trademarks of Daikin Industries, LTD. All rights reserved.

### Cautions on product corrosion

1. Air conditioners should not be installed in areas where corrosive gases, such as acid gas or alkaline gas, are produced.
2. If the outdoor unit is to be installed close to the sea shore, direct exposure to the sea breeze should be avoided. If you need to install the outdoor unit close to the sea shore, contact your local distributor.



JMI-0107

Organization:  
DAIKIN INDUSTRIES, LTD.  
AIR CONDITIONING MANUFACTURING DIVISION

Scope of Registration:  
THE DESIGN/DEVELOPMENT AND MANUFACTURE OF COMMERCIAL AIR CONDITIONING, HEATING, COOLING, REFRIGERATING EQUIPMENT, HEATING EQUIPMENT, RESIDENTIAL AIR CONDITIONING EQUIPMENT, HEAT RECLAIM VENTILATION, AIR CLEANING EQUIPMENT, COMPRESSORS AND VALVES.



JQA-1452

Organization:  
DAIKIN INDUSTRIES  
(THAILAND) LTD.

Scope of Registration:  
THE DESIGN/DEVELOPMENT AND MANUFACTURE OF AIR CONDITIONERS AND THE COMPONENTS INCLUDING COMPRESSORS USED FOR THEM



EC99J2044

All of the Daikin Group's business facilities and subsidiaries in Japan are certified under the ISO 14001 international standard for environment management.

### Dealer

**DAIKIN AC (AMERICAS), INC.**  
1645 Wallace Drive, Suite 110  
Carrollton, TX75006  
info@daikinac.com  
www.daikinac.com

© 2011 Daikin Industries, LTD.

● Specifications, designs and other content appearing in this brochure are current as of May 2012 but subject to change without notice.