



SiUS092230E

**R-410A**

# Service Manual

## Inverter Pair RX-W Series

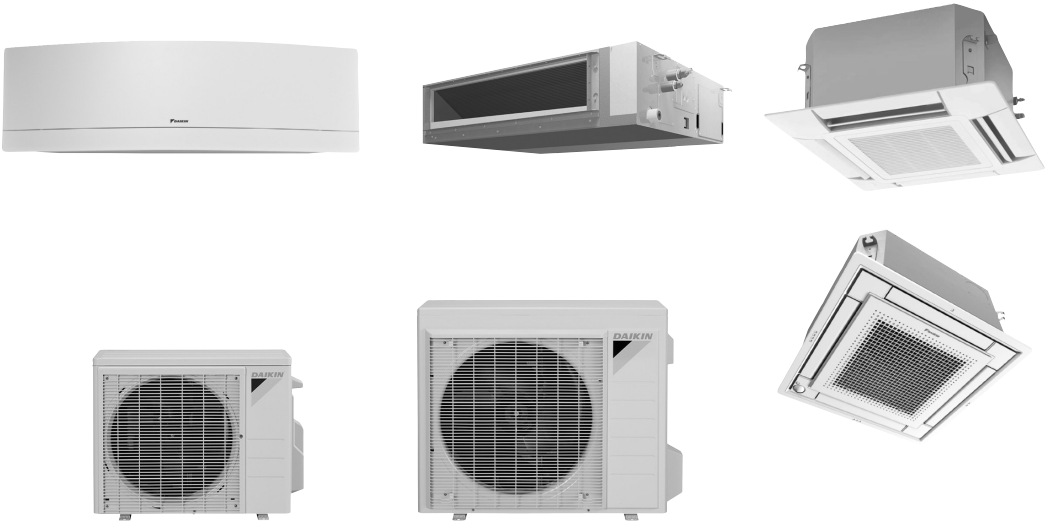

[Applied Models]  
● Inverter Pair : Heat Pump

<b>Introduction .....</b>	<b>1</b>
1. Safety Cautions .....	2
1.1 Warnings and Cautions Regarding Safety of Workers .....	2
1.2 Warnings and Cautions Regarding Safety of Users .....	4
2. Icons Used .....	7
3. Revision History .....	8
<b>Part 1 General Information .....</b>	<b>9</b>
1. Applicable Models .....	10
2. Functions .....	11
<b>Part 2 Specifications .....</b>	<b>13</b>
1. Specifications .....	14
1.1 Wall Mounted Type .....	14
1.2 Duct Concealed Type .....	17
1.3 Ceiling Cassette Type .....	20
<b>Part 3 Printed Circuit Board Connector Wiring Diagram .....</b>	<b>22</b>
1. Indoor Unit .....	23
1.1 FTXR09/12/18WVJUW(S)9 .....	23
1.2 FDMQ09/12/15/18/24WVJU9 .....	25
1.3 FFQ09/12/15/18W2VJU9 .....	27
2. Sensor Kit for FFQ Series .....	28
2.1 BRYQ60A2W(S) .....	28
3. Wired Remote Controller .....	29
3.1 BRC1E73 .....	29
4. Wireless Remote Controller Receiver for FDMQ Series .....	30
4.1 BRC082A43 .....	30
5. Wireless Remote Controller Kit for FFQ Series .....	31
5.1 BRC082A41W, BRC082A42W(S) .....	31
6. Outdoor Unit .....	32
6.1 RX09/12WMVJU9 .....	32
6.2 RX15/18/24WMVJU9 .....	34
<b>Part 4 Functions and Control .....</b>	<b>36</b>
1. Common Functions .....	38
1.1 Temperature Control .....	38
1.2 Frequency Principle .....	38
2. Functions for FTXR Series .....	40
2.1 Airflow Direction Control .....	40
2.2 Fan Speed Control for Indoor Unit .....	41
2.3 Program Dry Operation .....	42
2.4 Automatic Cooling/Heating Changeover .....	43
2.5 Thermostat Control .....	44

2.6	NIGHT SET Mode .....	45
2.7	ECONO Operation .....	45
2.8	2-Area INTELLIGENT EYE Operation .....	46
2.9	POWERFUL Operation .....	48
2.10	Multi-Monitor Lamp/TIMER Lamp .....	49
2.11	Clock Setting .....	50
2.12	WEEKLY TIMER Operation .....	51
2.13	Other Functions.....	57
3.	Functions for FDMQ/FFQ Series .....	58
3.1	Airflow Direction Control.....	58
3.2	Fan Speed Control for Indoor Unit .....	59
3.3	Program Dry Operation .....	60
3.4	Clock and Calendar Setting (With BRC1E73).....	61
3.5	Schedule Timer Operation (With BRC1E73).....	63
3.6	Setback Function (With BRC1E73).....	67
3.7	Drain Pump Control.....	68
3.8	Hot Start Control (In Heating Operation Only).....	70
3.9	Presence and Floor Sensors (Option).....	71
3.10	Other Functions.....	74
4.	Thermistor Functions .....	76
5.	Control Specification .....	77
5.1	Mode Hierarchy .....	77
5.2	Frequency Control.....	77
5.3	Controls at Mode Changing/Start-up.....	79
5.4	Discharge Pipe Temperature Control.....	82
5.5	Input Current Control.....	83
5.6	High Pressure Protection Control .....	84
5.7	Freeze-up Protection Control .....	85
5.8	Heating Peak-cut Control .....	86
5.9	Outdoor Fan Control.....	87
5.10	Liquid Compression Protection Function.....	87
5.11	Defrost Control .....	88
5.12	Electronic Expansion Valve Control .....	89
5.13	Malfunctions .....	92

## **Part 5 Remote Controller ..... 93**

1.	Applicable Remote Controller .....	94
2.	ARC466A36 .....	95
3.	BRC082A43 .....	97
4.	BRC082A41W, BRC082A42W(S).....	99
5.	BRC944B2 .....	101
6.	BRC1E73 .....	102

<b>Part 6 Service Diagnosis .....</b>	<b>108</b>
1. General Problem Symptoms and Check Items .....	110
2. Troubleshooting with LED .....	111
2.1 Indoor Unit.....	111
2.2 Outdoor Unit.....	113
3. Service Diagnosis .....	114
3.1 ARC466 Series.....	114
3.2 BRC1E73 .....	117
3.3 BRC082A43, BRC082A41W, BRC082A42W(S).....	119
4. Error Codes and Description.....	123
5. Troubleshooting for FTXR Series.....	124
5.1 Indoor Unit PCB Abnormality .....	124
5.2 Freeze-up Protection Control/Heating Peak-cut Control .....	126
5.3 Indoor Fan Motor (DC Motor) or Related Abnormality .....	127
5.4 Thermistor or Related Abnormality.....	130
5.5 Front Panel Open/Close Fault.....	131
5.6 Low-voltage Detection or Over-voltage Detection.....	132
5.7 Signal Transmission Error (Between Indoor Unit and Outdoor Unit).....	134
5.8 Unspecified Voltage (Between Indoor Unit and Outdoor Unit) .....	136
6. Troubleshooting for FDMQ, FFQ Series .....	137
6.1 Indoor Unit PCB Abnormality .....	137
6.2 Drain Level Control System Abnormality.....	138
6.3 Indoor Fan Motor or Related Abnormality .....	139
6.4 Indoor Fan PCB Abnormality.....	144
6.5 Humidifier or Related Abnormality.....	145
6.6 Thermistor or Related Abnormality.....	146
6.7 Presence Sensor or Floor Sensor Abnormality .....	147
6.8 Remote Controller Thermistor Abnormality .....	148
6.9 Low-voltage Detection or Over-voltage Detection.....	149
6.10 Signal Transmission Error (Between Indoor and Outdoor Unit) .....	151
6.11 Signal Transmission Error (Between Indoor Unit and Remote Controller) .....	153
6.12 Signal Transmission Error (Between MAIN/SUB Remote Controllers) ....	154
6.13 Unspecified Voltage (Between Indoor Unit and Outdoor Unit) .....	155
7. Troubleshooting for Outdoor Unit.....	156
7.1 Outdoor Unit PCB Abnormality.....	156
7.2 Actuation of High Pressure Switch .....	157
7.3 OL Activation (Compressor Overload) or HPS Activation (High Pressure Switch).....	159
7.4 OL Activation (Compressor Overload) .....	162
7.5 Compressor Lock .....	165
7.6 DC Fan Lock .....	166
7.7 Input Overcurrent Detection .....	167
7.8 Four Way Valve Abnormality.....	169
7.9 Discharge Pipe Temperature Control.....	171
7.10 High Pressure Control in Cooling .....	172



7.11 System Shutdown due to Temperature Abnormality in the Compressor .....	174
7.12 Compressor Sensor System Abnormality .....	175
7.13 Position Sensor Abnormality .....	176
7.14 DC Voltage/Current Sensor Abnormality .....	179
7.15 Thermistor or Related Abnormality (Outdoor Unit) .....	180
7.16 Electrical Box Temperature Rise .....	182
7.17 Radiation Fin Temperature Rise .....	183
7.18 Output Overcurrent Detection .....	185
8. Check .....	188
8.1 Thermistor Resistance Check .....	188
8.2 Indoor Fan Motor Connector Check .....	189
8.3 Power Supply Waveform Check .....	190
8.4 Electronic Expansion Valve Check .....	191
8.5 Four Way Valve Performance Check .....	192
8.6 Inverter Unit Refrigerant System Check .....	192
8.7 Inverter Analyzer Check .....	193
8.8 Outdoor Fan Motor Check .....	196
8.9 Installation Condition Check .....	197
8.10 Discharge Pressure Check .....	197
8.11 Outdoor Fan System Check .....	198
8.12 Main Circuit Short Check .....	198
8.13 Power Module Check .....	200

## **Part 7 Trial Operation and Field Settings ..... 202**

1. Pump Down Operation .....	203
2. Forced Cooling Operation .....	204
3. Trial Operation .....	206
3.1 FTXR Series .....	206
3.2 FDMQ, FFQ Series .....	207
4. Field Settings for FTXR Series .....	210
4.1 Temperature Display Switch .....	210
4.2 When 2 Units are Installed in 1 Room .....	210
4.3 Jumper and Switch Settings .....	211
5. Field Settings for FDMQ, FFQ Series .....	212
5.1 How to Change the Field Settings .....	212
5.2 Overview of Field Settings for FDMQ Series .....	215
5.3 Overview of Field Settings for FFQ Series .....	216
5.4 MAIN/SUB Setting when Using 2 Wired Remote Controllers .....	217
5.5 MAIN/SUB and Address Setting for Wireless Remote Controller for FDMQ Series .....	218
5.6 MAIN/SUB and Address Setting for Wireless Remote Controller for FFQ Series .....	221
6. Field Settings for Outdoor Unit .....	224
6.1 Facility Setting (cooling at low outdoor temperature) .....	224
6.2 Warmer Airflow Setting .....	225
6.3 Drain Pan Heater .....	226

---

7. Silicone Grease on Power Transistor/Diode Bridge .....	227
---	-----

**Part 8 Appendix .....** **228**

1. Piping Diagrams .....	229
1.1 Indoor Unit .....	229
1.2 Outdoor Unit .....	230
2. Wiring Diagrams .....	232
2.1 Indoor Unit .....	232
2.2 Outdoor Unit .....	235
3. Operation Limit .....	237

# Introduction

1. Safety Cautions .....	2
1.1 Warnings and Cautions Regarding Safety of Workers .....	2
1.2 Warnings and Cautions Regarding Safety of Users .....	4
2. Icons Used .....	7
3. Revision History .....	8

# 1. Safety Cautions

Be sure to read the following safety cautions before conducting repair work. After the repair work is complete, be sure to conduct a test operation to ensure that the equipment operates normally, and explain the cautions for operating the product to the customer.

	This manual is for the person in charge of maintenance and inspection.
---	--







## Caution Items







The caution items are classified into **Warning** and **Caution**. The **Warning** items are especially important since death or serious injury can result if they are not followed closely. The **Caution** items can also lead to serious accidents under some conditions if they are not followed. Therefore, be sure to observe all the safety caution items described below.







## Pictograms



- △ This symbol indicates an item for which caution must be exercised. The pictogram shows the item to which attention must be paid.
- This symbol indicates a prohibited action. The prohibited item or action is shown in the illustration or near the symbol.
- This symbol indicates an action that must be taken, or an instruction. The instruction is shown in the illustration or near the symbol.

## 1.1 Warnings and Cautions Regarding Safety of Workers









 <b>Warning</b>	
<p><b>Do not store equipment in a room with fire sources (e.g., naked flames, gas appliances, electric heaters).</b></p>	
<p><b>Be sure to disconnect the power cable from the socket before disassembling equipment for repair.</b>                      Working on equipment that is connected to the power supply may cause an electrical shock.                      If it is necessary to supply power to the equipment to conduct the repair or inspect the circuits, do not touch any electrically charged sections of the equipment.</p>	
<p><b>If refrigerant gas is discharged during repair work, do not touch the discharged refrigerant gas.</b>                      Refrigerant gas may cause frostbite.</p>	
<p><b>When disconnecting the suction or discharge pipe of the compressor at the welded section, evacuate the refrigerant gas completely at a well-ventilated place first.</b>                      If there is gas remaining inside the compressor, the refrigerant gas or refrigerating machine oil discharges when the pipe is disconnected, and it may cause injury.</p>	
<p><b>If refrigerant gas leaks during repair work, ventilate the area.</b>                      Refrigerant gas may generate toxic gases when it contacts flames.</p>	







 <b>Warning</b>	
<p><b>Be sure to discharge the capacitor completely before conducting repair work.</b> The step-up capacitor supplies high-voltage electricity to the electrical components of the outdoor unit. A charged capacitor may cause an electrical shock.</p>	
<p><b>Do not turn the air conditioner on or off by plugging in or unplugging the power cable.</b> Plugging in or unplugging the power cable to operate the equipment may cause an electrical shock or fire.</p>	
<p><b>Be sure to wear a safety helmet, gloves, and a safety belt when working in a high place (more than 2 m (6.5 ft)).</b> Insufficient safety measures may cause a fall.</p>	
<p><b>In case of R-32 / R-410A refrigerant models, be sure to use pipes, flare nuts and tools intended for the exclusive use with the R-32 / R-410A refrigerant.</b> The use of materials for R-22 refrigerant models may cause a serious accident, such as a damage of refrigerant cycle or equipment failure.</p>	
<p><b>Do not mix air or gas other than the specified refrigerant (R-32 / R-410A / R-22) in the refrigerant system.</b> If air enters the refrigerant system, an excessively high pressure results, causing equipment damage and injury.</p>	







 <b>Caution</b>	
<p><b>Do not repair electrical components with wet hands.</b> Working on the equipment with wet hands may cause an electrical shock.</p>	
<p><b>Do not clean the air conditioner with water.</b> Washing the unit with water may cause an electrical shock.</p>	
<p><b>Be sure to provide an earth / grounding when repairing the equipment in a humid or wet place, to avoid electrical shocks.</b></p>	
<p><b>Be sure to turn off the power switch and unplug the power cable when cleaning the equipment.</b> The internal fan rotates at a high speed, and may cause injury.</p>	
<p><b>Be sure to conduct repair work with appropriate tools.</b> The use of inappropriate tools may cause injury.</p>	





 <b>Caution</b>	
<p><b>Be sure to check that the refrigerating cycle section has cooled down enough before conducting repair work.</b> Working on the unit when the refrigerating cycle section is hot may cause burns.</p>	
<p><b>Conduct welding work in a well-ventilated place.</b> Using the welder in an enclosed room may cause oxygen deficiency.</p>	

## 1.2 Warnings and Cautions Regarding Safety of Users

 <b>Warning</b>	
<p><b>Do not store the equipment in a room with fire sources (e.g., naked flames, gas appliances, electric heaters).</b></p>	
<p><b>Be sure to use parts listed in the service parts list of the applicable model and appropriate tools to conduct repair work. Never attempt to modify the equipment.</b> The use of inappropriate parts or tools may cause an electrical shock, excessive heat generation or fire.</p>	
<p><b>If the power cable and lead wires are scratched or have deteriorated, be sure to replace them.</b> Damaged cable and wires may cause an electrical shock, excessive heat generation or fire.</p>	
<p><b>Do not use a joined power cable or extension cable, or share the same power outlet with other electrical appliances, since it may cause an electrical shock, excessive heat generation or fire.</b></p>	
<p><b>Be sure to use an exclusive power circuit for the equipment, and follow the local technical standards related to the electrical equipment, the internal wiring regulations, and the instruction manual for installation when conducting electrical work.</b> Insufficient power circuit capacity and improper electrical work may cause an electrical shock or fire.</p>	
<p><b>Be sure to use the specified cable for wiring between the indoor and outdoor units.</b> Make the connections securely and route the cable properly so that there is no force pulling the cable at the connection terminals. Improper connections may cause excessive heat generation or fire.</p>	
<p><b>When wiring between the indoor and outdoor units, make sure that the terminal cover does not lift off or dismount because of the cable.</b> If the cover is not mounted properly, the terminal connection section may cause an electrical shock, excessive heat generation or fire.</p>	
<p><b>Do not damage or modify the power cable.</b> Damaged or modified power cables may cause an electrical shock or fire. Placing heavy items on the power cable, or heating or pulling the power cable may damage it.</p>	

 <b>Warning</b>	
<p><b>Do not mix air or gas other than the specified refrigerant (R-32 / R-410A / R-22) in the refrigerant system.</b> If air enters the refrigerant system, an excessively high pressure results, causing equipment damage and injury.</p>	
<p><b>If the refrigerant gas leaks, be sure to locate the leaking point and repair it before charging the refrigerant. After charging the refrigerant, make sure that there is no leak.</b> If the leaking point cannot be located and the repair work must be stopped, be sure to pump-down, and close the service valve, to prevent refrigerant gas from leaking into the room. Refrigerant gas itself is harmless, but it may generate toxic gases when it contacts flames, such as those from fan type and other heaters, stoves and ranges.</p>	
<p><b>When relocating the equipment, make sure that the new installation site has sufficient strength to withstand the weight of the equipment.</b> If the installation site does not have sufficient strength or the installation work is not conducted securely, the equipment may fall and cause injury.</p>	
<p><b>Check to make sure that the power cable plug is not dirty or loose, then insert the plug into a power outlet securely.</b> If the plug is dusty or has a loose connection, it may cause an electrical shock or fire.</p>	
<p><b>When replacing the coin battery in the remote controller, be sure to dispose of the old battery to prevent children from swallowing it.</b> If a child swallows the coin battery, see a doctor immediately.</p>	





 <b>Caution</b>	
<p><b>Installation of a leakage breaker is necessary in some cases depending on the conditions of the installation site, to prevent electrical shocks.</b></p>	
<p><b>Do not install the equipment in a place where there is a possibility of combustible gas leaks.</b> If combustible gas leaks and remains around the unit, it may cause a fire.</p>	
<p><b>Check to see if parts and wires are mounted and connected properly, and if connections at the soldered or crimped terminals are secure.</b> Improper installation and connections may cause excessive heat generation, fire or an electrical shock.</p>	
<p><b>If the installation platform or frame has corroded, replace it.</b> A corroded installation platform or frame may cause the unit to fall, resulting in injury.</p>	
<p><b>Check the earth / grounding, and repair it if the equipment is not properly earthed / grounded.</b> Improper earth / grounding may cause an electrical shock.</p>	

 <b>Caution</b>	
<p><b>Be sure to measure insulation resistance after the repair, and make sure that the resistance is 1 MΩ or higher.</b>                      Faulty insulation may cause an electrical shock.</p>	
<p><b>Be sure to check the drainage of the indoor unit after the repair.</b>                      Faulty drainage may cause water to enter the room and wet the furniture and floor.</p>	
<p><b>Do not tilt the unit when removing it.</b>                      The water inside the unit may spill and wet the furniture and floor.</p>	



## 2. Icons Used

The following icons are used to attract the attention of the reader to specific information.

Icon	Type of Information	Description
 Warning	Warning	<b>Warning</b> is used when there is danger of personal injury.
 Caution	Caution	<b>Caution</b> is used when there is danger that the reader, through incorrect manipulation, may damage equipment, lose data, get an unexpected result or have to restart (part of) a procedure.
 Note	Note	<b>Note</b> provides information that is not indispensable, but may nevertheless be valuable to the reader, such as tips and tricks.
 Reference	Reference	<b>Reference</b> guides the reader to other places in this binder or in this manual, where he/she will find additional information on a specific topic.

### 3. Revision History

Month/Year	Version	Revised contents
11 / 2022	SiUS092230E	First edition

# Part 1

# General Information

1. Applicable Models .....	10
2. Functions.....	11

# 1. Applicable Models

---

## Indoor Unit

Wall mounted type	Duct concealed type	Ceiling cassette type
FTXR09WVJUW9	FDMQ09WVJU9	FFQ09W2VJU9
FTXR09WVJUS9	FDMQ12WVJU9	FFQ12W2VJU9
FTXR12WVJUW9	FDMQ15WVJU9	FFQ15W2VJU9
FTXR12WVJUS9	FDMQ18WVJU9	FFQ18W2VJU9
FTXR18WVJUW9	FDMQ24WVJU9	
FTXR18WVJUS9		

---

## Outdoor Unit

RX09WMVJU9  
RX12WMVJU9  
RX15WMVJU9  
RX18WMVJU9  
RX24WMVJU9

## 2. Functions

Category	Functions	Wall Mounted FTXR	Duct Concealed FDMQ		Ceiling Cassette FFQ			
					with BYFQ60B3W1		with BYFQ60C2W1W(S)	
			Wired R/C	Wireless R/C	Wired R/C	Wireless R/C	Wired R/C	Wireless R/C
Basic Function	Inverter (with inverter power control)	●	●	●	●	●	●	●
	Operation limit	Refer to page 237						
	PAM control	●	●	●	●	●	●	●
	Standby electricity saving	—	—	—	—	—	—	—
Compressor	Swing compressor	●	●	●	●	●	●	●
	Reluctance DC motor	●	●	●	●	●	●	●
Comfortable Airflow	Power-airflow dual flaps (horizontal blades)	●	—	—	—	—	—	—
	Wide-angle louvers (vertical blades)	●	—	—	—	—	—	—
	Auto-swing (up and down)	●	—	—	—	—	—	—
	Auto-swing (right and left)	●	—	—	—	—	—	—
	3-D airflow	●	—	—	—	—	—	—
	COMFORT AIRFLOW operation	●	—	—	—	—	—	—
	Auto-swing	—	—	—	●	●	●	●
	Individual flap control	—	—	—	—	—	●	—
Comfort Control	Auto fan speed	●	●	—	●	—	●	—
	Switchable fan speed	5 steps	3 steps	3 steps	3 steps	3 steps	3 steps	3 steps
	Indoor unit quiet operation	●	—	—	—	—	—	—
	2 selectable temperature sensors	—	●	—	—	—	—	—
	Presence and floor sensor (option)	—	—	—	—	—	Option	—
	Hot-start function	●	●	●	●	●	●	●
	QUIET OUTDOOR UNIT operation (manual)	●	—	—	—	—	—	—
	INTELLIGENT EYE operation (auto energy saving)	●	—	—	—	—	—	—
	2-area INTELLIGENT EYE operation (comfort)	●	—	—	—	—	—	—
	Quick warming function	●	●	●	●	●	●	●
Automatic defrosting	●	●	●	●	●	●	●	
Operation	Automatic cooling/heating changeover	●	●	●	●	●	●	●
	Program dry operation	●	●	●	●	●	●	●
	Fan only	●	●	●	●	●	●	●
	Setback function	—	—	—	●	—	●	—
Lifestyle Convenience	Inverter POWERFUL operation	●	—	—	—	—	—	—
	ECONO operation	●	—	—	—	—	—	—
	Indoor unit ON/OFF switch	●	—	—	—	—	—	—
	Emergency operation switch	—	—	●	—	●	—	●
	Multi-colored indicator lamp	●	—	—	—	—	—	—
	Multi-colored lamp brightness setting	●	—	—	—	—	—	—
	Signal receiving sign	●	—	●★	—	●★	—	●★
	Remote controller with back light	●	●	—	●	—	●	—

Category	Functions	Wall Mounted FTXR	Duct Concealed FDMQ		Ceiling Cassette FFQ			
					with BYFQ60B3W1		with BYFQ60C2W1W(S)	
			Wired R/C	Wireless R/C	Wired R/C	Wireless R/C	Wired R/C	Wireless R/C
Health and Cleanliness	Titanium apatite deodorizing filter	●	—	—	—	—	—	—
	Mold proof air filter	●	—	—	—	—	—	—
	Longlife filter	—	—	—	Option	Option	Option	Option
	Filter cleaning indicator	—	●	●	●	●	●	●
	Wipe-clean flat panel	●	—	—	—	—	—	—
	Silver ion anti-bacterial drain pan	—	●	●	—	—	—	—
Timer	WEEKLY TIMER operation	●	—	—	—	—	—	—
	Schedule timer	—	●	—	●	—	●	—
	Setpoint auto reset	—	●	—	—	—	—	—
	Setpoint range set	—	●	—	—	—	—	—
	24-hour ON/OFF TIMER	●	●	—	●	—	●	—
	72-hour ON/OFF TIMER	—	—	●	—	●	—	●
	Off timer (turns unit off after set time)	—	●	—	●	—	●	—
	NIGHT SET mode	●	—	—	—	—	—	—
Remote Control	Remote control adaptor (normal open pulse contact)	Option	—	—	—	—	—	—
	Remote control adaptor (normal open contact)	Option	—	—	—	—	—	—
	DIII-NET compatible (adaptor)	Option	Option	Option	Option	Option	Option	Option
	Wireless LAN connection	Option	Option	Option	Option	Option	Option	Option
Worry Free (Reliability & Durability)	Auto-restart (after power failure)	●	●	●	●	●	●	●
	Self-diagnosis (R/C, LED)	●	●	●	●	●	●	●
	Anti-corrosion treatment of outdoor heat exchanger	●	●	●	●	●	●	●
Work & Servicing	Multi-split/split type compatible indoor unit	●	●	●	●	●	●	●
	Either side drain (right or left)	●	—	—	—	—	—	—
	Chargeless	32.8 ft. (10m)	32.8 ft. (10m)	32.8 ft. (10m)	32.8 ft. (10m)	32.8 ft. (10m)	32.8 ft. (10m)	32.8 ft. (10m)
	Drain pump	—	●	●	●	●	●	●
	Low temperature cooling operation (14°F (-10°C))	●	●	●	●	●	●	●
	Low temperature cooling operation (-4°F (-20°C)) Requires wind baffle and field settings	●	●	●	●	●	●	●
	°F/°C changeover R/C temperature display (factory setting: °F)	●	●	— (°F only)	●	— (°F only)	●	— (°F only)

● : Available  
 — : Not available

★ : Receiving sound only

# Part 2 Specifications

1. Specifications .....	14
1.1 Wall Mounted Type .....	14
1.2 Duct Concealed Type.....	17
1.3 Ceiling Cassette Type .....	20

# 1. Specifications

## 1.1 Wall Mounted Type

Model	Indoor Unit		FTXR09WVJWU9		FTXR09WVJUS9	
	Outdoor Unit		RX09WMVJU9		RX09WMVJU9	
			Cooling	Heating	Cooling	Heating
Power Supply			1 $\phi$ , 208 - 230 V, 60 Hz		1 $\phi$ , 208 - 230 V, 60 Hz	
Capacity Rated (Min. - Max.)		Btu/h	9,000 (4,500 - 10,600)	10,000 (4,100 - 14,600)	9,000 (4,500 - 10,600)	10,000 (4,100 - 14,600)
Running Current (Rated)		A	4.28 - 3.87	3.83 - 3.46	4.28 - 3.87	3.83 - 3.46
Power Consumption (Rated)		W	819 - 819	733 - 733	819 - 819	733 - 733
Power Factor (Rated)		%	92.0 - 92.0	92.0 - 92.1	92.0 - 92.0	92.0 - 92.1
SEER2 / HSPF2			18.00	7.50	18.00	7.50
EER2 (Rated)		Btu/h·W	11.00	—	11.00	—
COP2 (Rated)		W/W	—	4.00	—	4.00
Piping Connections	Liquid	in. (mm)	$\phi$ 1/4 (6.4)		$\phi$ 1/4 (6.4)	
	Gas	in. (mm)	$\phi$ 3/8 (9.5)		$\phi$ 3/8 (9.5)	
	Drain	in. (mm)	$\phi$ 11/16 (18)		$\phi$ 11/16 (18)	
Heat Insulation			Both Liquid and Gas Pipes		Both Liquid and Gas Pipes	
Max. Interunit Piping Length		ft (m)	65-5/8 (20)		65-5/8 (20)	
Max. Interunit Height Difference		ft (m)	49-1/4 (15)		49-1/4 (15)	
Chargeless		ft (m)	32-3/4 (10)		32-3/4 (10)	
Amount of Additional Charge of Refrigerant		oz/ft (g/m)	0.21 (20)		0.21 (20)	
<b>Indoor Unit</b>			<b>FTXR09WVJWU9</b>		<b>FTXR09WVJUS9</b>	
Front Panel Color			White		Silver	
Airflow Rate	H / M / L / SL	cfm	272 / 208 / 162 / 134	346 / 258 / 201 / 117	272 / 208 / 162 / 134	346 / 258 / 201 / 117
		m <sup>3</sup> /min	7.7 / 5.9 / 4.6 / 3.8	9.8 / 7.3 / 5.7 / 3.3	7.7 / 5.9 / 4.6 / 3.8	9.8 / 7.3 / 5.7 / 3.3
Fan	Type / Speed	Steps	Cross Flow Fan / 5 Steps, Quiet, Auto		Cross Flow Fan / 5 Steps, Quiet, Auto	
Air Direction Control			Right, Left, Horizontal, Downward		Right, Left, Horizontal, Downward	
Air Filter			Removable, Washable		Removable, Washable	
Running Current (Rated)		A	0.07 - 0.07	0.13 - 0.12	0.07 - 0.07	0.13 - 0.12
Power Consumption (Rated)		W	13 - 13	26 - 26	13 - 13	26 - 26
Power Factor (Rated)		%	89.2 - 80.7	96.2 - 94.2	89.2 - 80.7	96.2 - 94.2
Temperature Control			Microcomputer Control		Microcomputer Control	
Dimensions (H × W × D)		in. (mm)	11-15/16 × 39-5/16 × 8-3/8 (303 × 998 × 212)		11-15/16 × 39-5/16 × 8-3/8 (303 × 998 × 212)	
Packaged Dimensions (H × W × D)		in. (mm)	12-11/16 × 43-3/8 × 15-5/16 (322 × 1,101 × 389)		12-11/16 × 43-3/8 × 15-5/16 (322 × 1,101 × 389)	
Weight (Mass)		lbs (kg)	27 (12)		27 (12)	
Gross Weight (Gross Mass)		lbs (kg)	33 (15)		33 (15)	
Sound Pressure Level		H / M / L / SL dB(A)	38 / 32 / 25 / 19	41 / 34 / 28 / 19	38 / 32 / 25 / 19	41 / 34 / 28 / 19
<b>Outdoor Unit</b>			<b>RX09WMVJU9</b>		<b>RX09WMVJU9</b>	
Casing Color			Ivory White		Ivory White	
Heat Exchanger		Fin Spec / Tube	Waffle Fin (PE) / $\phi$ 7 Hi-XSL Tube		Waffle Fin (PE) / $\phi$ 7 Hi-XSL Tube	
Fan Motor		Motor Output HP	0.03		0.03	
Compressor		Type	Hermetically Sealed Swing Type		Hermetically Sealed Swing Type	
		Model	1YC23AUXD		1YC23AUXD	
Refrigerant Oil		Type	FVC50K		FVC50K	
		Charge	oz (L)		12.68 (0.375)	
Refrigerant		Type	R-410A		R-410A	
		Charge	lbs (kg)		2.09 (0.95)	
Airflow Rate		cfm (m <sup>3</sup> /min)	985 (27.9)	1,144 (32.4)	985 (27.9)	1,144 (32.4)
Fan		Type	Propeller		Propeller	
Running Current (Rated)		A	4.21 - 3.80	3.70 - 3.34	4.21 - 3.80	3.70 - 3.34
Power Consumption (Rated)		W	806 - 806	707 - 707	806 - 806	707 - 707
Power Factor (Rated)		%	92.0 - 92.2	95.2 - 95.4	92.0 - 92.2	95.2 - 95.4
Dimensions (H × W × D)		in. (mm)	21-5/8 × 26-9/16 × 11-3/16 (550 × 675 × 284)		21-5/8 × 26-9/16 × 11-3/16 (550 × 675 × 284)	
Packaged Dimensions (H × W × D)		in. (mm)	23-13/16 × 31-7/16 × 14-11/16 (605 × 798 × 373)		23-13/16 × 31-7/16 × 14-11/16 (605 × 798 × 373)	
Weight (Mass)		lbs (kg)	63 (29)		63 (29)	
Gross Weight (Gross Mass)		lbs (kg)	68 (31)		68 (31)	
Sound Pressure Level		dB(A)	46	50	46	50
Conditions Based on		Indoor	80.0°FDB (26.7°CDB) / 67.0°FWB (19.4°CWB)	70.0°FDB (21.1°CDB) / 60.0°FWB (15.6°CWB)	80.0°FDB (26.7°CDB) / 67.0°FWB (19.4°CWB)	70.0°FDB (21.1°CDB) / 60.0°FWB (15.6°CWB)
		Outdoor	95.0°FDB (35.0°CDB) / 75.0°FWB (24.0°CWB)	47.0°FDB (8.3°CDB) / 43.0°FWB (6.1°CWB)	95.0°FDB (35.0°CDB) / 75.0°FWB (24.0°CWB)	47.0°FDB (8.3°CDB) / 43.0°FWB (6.1°CWB)
Piping Length			25 ft (7.5 m)		25 ft (7.5 m)	
Drawing No.			C: 3D143145		C: 3D143145	
Note(s)			SL: The quiet fan level of the airflow rate setting.			

Conversion Formulae	
kcal/h = kW × 860	
Btu/h = kW × 3412	
cfm = m <sup>3</sup> /min × 35.3	



Model	Indoor Unit		FTXR12WVJUW9		FTXR12WVJUS9	
	Outdoor Unit		RX12WMVJU9		RX12WMVJU9	
			Cooling	Heating	Cooling	Heating
Power Supply		1 ϕ, 208 - 230 V, 60 Hz				
Capacity Rated (Min. - Max.)	Btu/h	12,000 (4,500 - 12,800)	13,500 (4,100 - 15,800)	12,000 (4,500 - 12,800)	13,500 (4,100 - 15,800)	
Running Current (Rated)	A	5.46 - 4.94	5.60 - 5.06	5.46 - 4.94	5.60 - 5.06	
Power Consumption (Rated)	W	1,091 - 1,091	1,106 - 1,106	1,091 - 1,091	1,106 - 1,106	
Power Factor (Rated)	%	96.1 - 96.0	95.0 - 95.0	96.1 - 96.0	95.0 - 95.0	
SEER2 / HSPF2		17.00	8.00	17.00	8.00	
EER2 (Rated)	Btu/h·W	11.00	—	11.00	—	
COP2 (Rated)	W/W	—	3.58	—	3.58	
Piping Connections	Liquid	in. (mm)	ϕ 1/4 (6.4)		ϕ 1/4 (6.4)	
	Gas	in. (mm)	ϕ 3/8 (9.5)		ϕ 3/8 (9.5)	
	Drain	in. (mm)	ϕ 11/16 (18)		ϕ 11/16 (18)	
Heat Insulation		Both Liquid and Gas Pipes				
Max. Interunit Piping Length	ft (m)	65-5/8 (20)		65-5/8 (20)		
Max. Interunit Height Difference	ft (m)	49-1/4 (15)		49-1/4 (15)		
Chargeless	ft (m)	32-3/4 (10)		32-3/4 (10)		
Amount of Additional Charge of Refrigerant	oz/ft (g/m)	0.21 (20)		0.21 (20)		
<b>Indoor Unit</b>		<b>FTXR12WVJUW9</b>		<b>FTXR12WVJUS9</b>		
Front Panel Color		White		Silver		
Airflow Rate	H / M / L / SL	cfm	335 / 219 / 169 / 131	395 / 290 / 226 / 131	335 / 219 / 169 / 131	395 / 290 / 226 / 131
		m <sup>3</sup> /min	9.5 / 6.2 / 4.8 / 3.7	11.2 / 8.2 / 6.4 / 3.7	9.5 / 6.2 / 4.8 / 3.7	11.2 / 8.2 / 6.4 / 3.7
Fan	Type / Speed	Steps	Cross Flow Fan / 5 Steps, Quiet, Auto		Cross Flow Fan / 5 Steps, Quiet, Auto	
Air Direction Control		Right, Left, Horizontal, Downward		Right, Left, Horizontal, Downward		
Air Filter		Removable, Washable		Removable, Washable		
Running Current (Rated)	A	0.13 - 0.12	0.19 - 0.17	0.13 - 0.12	0.19 - 0.17	
Power Consumption (Rated)	W	26 - 26	38 - 38	26 - 26	38 - 38	
Power Factor (Rated)	%	96.1 - 94.2	96.1 - 97.1	96.1 - 94.2	96.1 - 97.1	
Temperature Control		Microcomputer Control		Microcomputer Control		
Dimensions (H × W × D)	in. (mm)	11-15/16 × 39-5/16 × 8-3/8 (303 × 998 × 212)		11-15/16 × 39-5/16 × 8-3/8 (303 × 998 × 212)		
Packaged Dimensions (H × W × D)	in. (mm)	12-11/16 × 43-3/8 × 15-5/16 (322 × 1,101 × 389)		12-11/16 × 43-3/8 × 15-5/16 (322 × 1,101 × 389)		
Weight (Mass)	lbs (kg)	27 (12)		27 (12)		
Gross Weight (Gross Mass)	lbs (kg)	33 (15)		33 (15)		
Sound Pressure Level	H / M / L / SL	dB(A) 45 / 34 / 26 / 20		dB(A) 45 / 34 / 26 / 20		
<b>Outdoor Unit</b>		<b>RX12WMVJU9</b>		<b>RX12WMVJU9</b>		
Casing Color		Ivory White		Ivory White		
Heat Exchanger	Fin Spec / Tube	Waffle Fin (PE) / ϕ 7 Hi-XSL Tube		Waffle Fin (PE) / ϕ 7 Hi-XSL Tube		
Fan Motor	Motor Output	HP	0.03		0.03	
Compressor	Type	Hermetically Sealed Swing Type		Hermetically Sealed Swing Type		
	Model	1YC23AUXD		1YC23AUXD		
Refrigerant Oil	Type	FVC50K		FVC50K		
	Charge	oz (L)	12.68 (0.375)		12.68 (0.375)	
Refrigerant	Type	R-410A		R-410A		
	Charge	lbs (kg)	2.09 (0.95)		2.09 (0.95)	
Airflow Rate	cfm (m <sup>3</sup> /min)	1,105 (31.3)	1,144 (32.4)	1,105 (31.3)	1,144 (32.4)	
Fan	Type	Propeller		Propeller		
Running Current (Rated)	A	5.33 - 4.82	5.41 - 4.89	5.33 - 4.82	5.41 - 4.89	
Power Consumption (Rated)	W	1,065 - 1,065	1,068 - 1,068	1,065 - 1,065	1,068 - 1,068	
Power Factor (Rated)	%	96.1 - 96.1	94.9 - 95.0	96.1 - 96.1	94.9 - 95.0	
Dimensions (H × W × D)	in. (mm)	21-5/8 × 26-9/16 × 11-3/16 (550 × 675 × 284)		21-5/8 × 26-9/16 × 11-3/16 (550 × 675 × 284)		
Packaged Dimensions (H × W × D)	in. (mm)	23-13/16 × 31-7/16 × 14-11/16 (605 × 798 × 373)		23-13/16 × 31-7/16 × 14-11/16 (605 × 798 × 373)		
Weight (Mass)	lbs (kg)	63 (29)		63 (29)		
Gross Weight (Gross Mass)	lbs (kg)	68 (31)		68 (31)		
Sound Pressure Level	dB(A)	49	51	49	51	
Conditions Based on	Indoor	80.0°FDB (26.7°CDB) / 67.0°FWB (19.4°CWB)		80.0°FDB (26.7°CDB) / 67.0°FWB (19.4°CWB)		
	Outdoor	95.0°FDB (35.0°CDB) / 75.0°FWB (24.0°CWB)		95.0°FDB (35.0°CDB) / 75.0°FWB (24.0°CWB)		
	Piping Length	25 ft (7.5 m)		25 ft (7.5 m)		
Drawing No.	C: 3D143146					
Note(s)	SL: The quiet fan level of the airflow rate setting.					

Conversion Formulae	
kcal/h	= kW × 860
Btu/h	= kW × 3412
cfm	= m <sup>3</sup> /min × 35.3

Model	Indoor Unit		FTXR18WVJUW9		FTXR18WVJUS9	
	Outdoor Unit		RX18WMVJU9		RX18WMVJU9	
			Cooling	Heating	Cooling	Heating
Power Supply			1 $\phi$ , 208 - 230 V, 60 Hz		1 $\phi$ , 208 - 230 V, 60 Hz	
Capacity Rated (Min. - Max.)	Btu/h		18,000 (5,100 - 18,500)	20,000 (5,800 - 21,200)	18,000 (5,100 - 18,500)	20,000 (5,800 - 21,200)
Running Current (Rated)	A		9.29 - 8.40	8.70 - 7.89	9.29 - 8.40	8.70 - 7.89
Power Consumption (Rated)	W		1,875 - 1,875	1,755 - 1,755	1,875 - 1,875	1,755 - 1,755
Power Factor (Rated)	%		97.0 - 97.0	97.0 - 97.0	97.0 - 97.0	97.0 - 97.0
SEER2 / HSPF2			14.50	7.80	14.50	7.80
EER2 (Rated)	Btu/h·W		9.60	—	9.60	—
COP2 (Rated)	W/W		—	3.34	—	3.34
Piping Connections	Liquid	in. (mm)	$\phi$ 1/4 (6.4)		$\phi$ 1/4 (6.4)	
	Gas	in. (mm)	$\phi$ 1/2 (12.7)		$\phi$ 1/2 (12.7)	
	Drain	in. (mm)	$\phi$ 11/16 (18)		$\phi$ 11/16 (18)	
Heat Insulation			Both Liquid and Gas Pipes		Both Liquid and Gas Pipes	
Max. Interunit Piping Length	ft (m)		98-1/2 (30)		98-1/2 (30)	
Max. Interunit Height Difference	ft (m)		65-5/8 (20)		65-5/8 (20)	
Chargeless	ft (m)		32-3/4 (10)		32-3/4 (10)	
Amount of Additional Charge of Refrigerant	oz/ft (g/m)		0.21 (20)		0.21 (20)	
<b>Indoor Unit</b>			<b>FTXR18WVJUW9</b>		<b>FTXR18WVJUS9</b>	
Front Panel Color			White		Silver	
Airflow Rate	H / M / L / SL	cfm	350 / 275 / 226 / 208	413 / 332 / 275 / 208	350 / 275 / 226 / 208	413 / 332 / 275 / 208
		m <sup>3</sup> /min	9.9 / 7.8 / 6.4 / 5.9	11.7 / 9.4 / 7.8 / 5.9	9.9 / 7.8 / 6.4 / 5.9	11.7 / 9.4 / 7.8 / 5.9
Fan	Type / Speed	Steps	Cross Flow Fan / 5 Steps, Quiet, Auto		Cross Flow Fan / 5 Steps, Quiet, Auto	
Air Direction Control			Right, Left, Horizontal, Downward		Right, Left, Horizontal, Downward	
Air Filter			Removable, Washable		Removable, Washable	
Running Current (Rated)	A		0.07 - 0.07	0.13 - 0.12	0.07 - 0.07	0.13 - 0.12
Power Consumption (Rated)	W		28 - 28	42 - 42	28 - 28	42 - 42
Power Factor (Rated)	%		96.1 - 87.0	96.2 - 87.0	96.1 - 87.0	96.2 - 87.0
Temperature Control			Microcomputer Control		Microcomputer Control	
Dimensions (H x W x D)	in. (mm)		11-15/16 x 39-5/16 x 8-3/8 (303 x 998 x 212)		11-15/16 x 39-5/16 x 8-3/8 (303 x 998 x 212)	
Packaged Dimensions (H x W x D)	in. (mm)		12-11/16 x 43-3/8 x 15-5/16 (322 x 1,101 x 389)		12-11/16 x 43-3/8 x 15-5/16 (322 x 1,101 x 389)	
Weight (Mass)	lbs (kg)		27 (12)		27 (12)	
Gross Weight (Gross Mass)	lbs (kg)		33 (15)		33 (15)	
Sound Pressure Level	H / M / L / SL	dB(A)	46 / 40 / 35 / 30		46 / 40 / 35 / 30	
<b>Outdoor Unit</b>			<b>RX18WMVJU9</b>		<b>RX18WMVJU9</b>	
Casing Color			Ivory White		Ivory White	
Heat Exchanger	Fin Spec / Tube		Waffle Fin (PE) / $\phi$ 7 Hi-XSL Tube		Waffle Fin (PE) / $\phi$ 7 Hi-XSL Tube	
Fan Motor	Motor Output	HP	0.12		0.12	
Compressor	Type		Hermetically Sealed Swing Type		Hermetically Sealed Swing Type	
	Model		2YC36PXD		2YC36PXD	
Refrigerant Oil	Type		FVC50K		FVC50K	
	Charge	oz (L)	21.98 (0.650)		21.98 (0.650)	
Refrigerant	Type		R-410A		R-410A	
	Charge	lbs (kg)	2.49 (1.13)		2.49 (1.13)	
Airflow Rate		cfm (m <sup>3</sup> /min)	2,461 (69.7)	2,553 (72.3)	2,461 (69.7)	2,553 (72.3)
Fan	Type		Propeller		Propeller	
Running Current (Rated)	A		9.22 - 8.33	8.57 - 7.77	9.22 - 8.33	8.57 - 7.77
Power Consumption (Rated)	W		1,847 - 1,847	1,713 - 1,713	1,847 - 1,847	1,713 - 1,713
Power Factor (Rated)	%		96.3 - 96.4	96.1 - 95.9	96.3 - 96.4	96.1 - 95.9
Dimensions (H x W x D)	in. (mm)		28-15/16 x 34-1/4 x 12-5/8 (735 x 870 x 320)		28-15/16 x 34-1/4 x 12-5/8 (735 x 870 x 320)	
Packaged Dimensions (H x W x D)	in. (mm)		31-7/8 x 41-9/16 x 18-1/4 (810 x 1,056 x 464)		31-7/8 x 41-9/16 x 18-1/4 (810 x 1,056 x 464)	
Weight (Mass)	lbs (kg)		100 (45)		100 (45)	
Gross Weight (Gross Mass)	lbs (kg)		110 (50)		110 (50)	
Sound Pressure Level		dB(A)	54	55	54	55
Conditions Based on	Indoor		80.0°FDB (26.7°CDB) / 67.0°FWB (19.4°CWB)		80.0°FDB (26.7°CDB) / 67.0°FWB (19.4°CWB)	
	Outdoor		95.0°FDB (35.0°CDB) / 75.0°FWB (24.0°CWB)		95.0°FDB (35.0°CDB) / 75.0°FWB (24.0°CWB)	
	Piping Length		25 ft (7.5 m)		25 ft (7.5 m)	
Drawing No.			C: 3D143147A		C: 3D143147A	
Note(s)	SL: The quiet fan level of the airflow rate setting.					

Conversion Formulae	
kcal/h = kW x 860	
Btu/h = kW x 3412	
cfm = m <sup>3</sup> /min x 35.3	

# 1.2 Duct Concealed Type

Model	Indoor Unit		FDMQ09WVJU9		FDMQ12WVJU9	
	Outdoor Unit		RX09WMVJU9		RX12WMVJU9	
			Cooling	Heating	Cooling	Heating
Power Supply			1 ϕ, 208 - 230 V, 60 Hz		1 ϕ, 208 - 230 V, 60 Hz	
Capacity Rated (Min. - Max.)	Btu/h		9,000 (3,900 - 9,400)	10,900 (3,900 - 12,800)	10,800 (4,000 - 12,400)	13,600 (3,900 - 14,200)
Running Current (Rated)	A		5.30 - 4.79	5.34 - 4.83	6.14 - 5.55	6.48 - 5.86
Power Consumption (Rated)	W		1,059 - 1,059	1,065 - 1,065	1,227 - 1,227	1,329 - 1,329
Power Factor (Rated)	%		96.1 - 96.1	95.9 - 95.8	96.1 - 96.2	98.6 - 98.6
SEER2 / HSPF2			14.30	8.20	14.60	8.10
EER2 (Rated)	Btu/h-W		8.50	—	8.80	—
COP2 (Rated)	W/W		—	3.00	—	3.00
Piping Connections	Liquid	in. (mm)	ϕ 1/4 (6.4)		ϕ 1/4 (6.4)	
	Gas	in. (mm)	ϕ 3/8 (9.5)		ϕ 3/8 (9.5)	
	Drain	in. (mm)	I.D. ϕ 1 (25) / O.D. ϕ 1-1/4 (32)		I.D. ϕ 1 (25) / O.D. ϕ 1-1/4 (32)	
Heat Insulation			Both Liquid and Gas Pipes		Both Liquid and Gas Pipes	
Max. Interunit Piping Length	ft (m)		65-5/8 (20)		65-5/8 (20)	
Max. Interunit Height Difference	ft (m)		49-1/4 (15)		49-1/4 (15)	
Chargeless	ft (m)		32-3/4 (10)		32-3/4 (10)	
Amount of Additional Charge of Refrigerant	oz/ft (g/m)		0.21 (20)		0.21 (20)	
<b>Indoor Unit</b>			<b>FDMQ09WVJU9</b>		<b>FDMQ12WVJU9</b>	
Heat Exchanger	Rows × Stages, Fin per Inch		3 × 26, 18		3 × 26, 18	
	Fin Spec / Tube		Multi Slit Fin / ϕ 5 Hi-XA Tube		Multi Slit Fin / ϕ 5 Hi-XA Tube	
Airflow Rate	H / M / L	cfm	293 / 265 / 233	293 / 265 / 233	371 / 318 / 261	371 / 318 / 261
		m <sup>3</sup> /min	8.3 / 7.5 / 6.6	8.3 / 7.5 / 6.6	10.5 / 9.0 / 7.4	10.5 / 9.0 / 7.4
Fan Motor	H / M / L	rpm	997 / 896 / 795	997 / 896 / 795	1,089 / 930 / 771	1,089 / 930 / 771
		Motor Output	HP	0.17		0.17
Fan	Type		Sirocco Fan		Sirocco Fan	
External Static Pressure	inH <sub>2</sub> O	Pa	Standard 0.20 (0.60 - 0.12)		Standard 0.20 (0.60 - 0.12)	
			Standard 50 (150 - 30)		Standard 50 (150 - 30)	
Running Current (Rated)	A		0.40 - 0.36	0.40 - 0.36	0.44 - 0.40	0.44 - 0.40
Power Consumption (Rated)	W		75 - 75	75 - 75	89 - 89	89 - 89
Power Factor (Rated)	%		90.2 - 90.7	90.2 - 90.7	97.0 - 97.6	97.0 - 97.6
Temperature Control			Microcomputer Control		Microcomputer Control	
Dimensions (H × W × D)	in. (mm)		9-5/8 × 27-9/16 × 31-1/2 (245 × 700 × 800)		9-5/8 × 27-9/16 × 31-1/2 (245 × 700 × 800)	
Packaged Dimensions (H × W × D)	in. (mm)		11-9/16 × 35-3/8 × 34-7/8 (293 × 899 × 886)		11-9/16 × 35-3/8 × 34-7/8 (293 × 899 × 886)	
Weight (Mass)	lbs (kg)		64 (29)		64 (29)	
Gross Weight (Gross Mass)	lbs (kg)		71 (32)		71 (32)	
Sound Pressure Level	dB(A)		32	32	33	33
Remote Controller (Option)	Wired		BRC1E73		BRC1E73	
	Wireless		BRC082A43		BRC082A43	
<b>Outdoor Unit</b>			<b>RX09WMVJU9</b>		<b>RX12WMVJU9</b>	
Casing Color			Ivory White		Ivory White	
Heat Exchanger	Fin Spec / Tube		Waffle Fin (PE) / ϕ 7 Hi-XSL Tube		Waffle Fin (PE) / ϕ 7 Hi-XSL Tube	
Fan Motor	Motor Output	HP	0.03		0.03	
Compressor	Type		Hermetically Sealed Swing Type		Hermetically Sealed Swing Type	
	Model		1YC23AUXD		1YC23AUXD	
Refrigerant Oil	Type		FVC50K		FVC50K	
	Charge	oz (L)	12.68 (0.375)		12.68 (0.375)	
Refrigerant	Type		R-410A		R-410A	
	Charge	lbs (kg)	2.09 (0.95)		2.09 (0.95)	
Airflow Rate	cfm (m <sup>3</sup> /min)		985 (27.9)	1,144 (32.4)	1,105 (31.3)	1,144 (32.4)
Fan	Type		Propeller		Propeller	
Running Current (Rated)	A		4.90 - 4.43	4.94 - 4.47	5.70 - 5.15	6.04 - 5.46
Power Consumption (Rated)	W		984 - 984	990 - 990	1,138 - 1,138	1,240 - 1,240
Power Factor (Rated)	%		96.5 - 96.6	96.3 - 96.3	96.0 - 96.1	98.7 - 98.7
Dimensions (H × W × D)	in. (mm)		21-5/8 × 26-9/16 × 11-3/16 (550 × 675 × 284)		21-5/8 × 26-9/16 × 11-3/16 (550 × 675 × 284)	
Packaged Dimensions (H × W × D)	in. (mm)		23-13/16 × 31-7/16 × 14-11/16 (605 × 798 × 373)		23-13/16 × 31-7/16 × 14-11/16 (605 × 798 × 373)	
Weight (Mass)	lbs (kg)		63 (29)		63 (29)	
Gross Weight (Gross Mass)	lbs (kg)		68 (31)		68 (31)	
Sound Pressure Level	dB(A)		46	50	49	51
Conditions Based on	Indoor		80.0°FDB (26.7°CDB) / 67.0°FWB (19.4°CWB)	70.0°FDB (21.1°CDB) / 60.0°FWB (15.6°CWB)	80.0°FDB (26.7°CDB) / 67.0°FWB (19.4°CWB)	70.0°FDB (21.1°CDB) / 60.0°FWB (15.6°CWB)
			95.0°FDB (35.0°CDB) / 75.0°FWB (24.0°CWB)	47.0°FDB (8.3°CDB) / 43.0°FWB (6.1°CWB)	95.0°FDB (35.0°CDB) / 75.0°FWB (24.0°CWB)	47.0°FDB (8.3°CDB) / 43.0°FWB (6.1°CWB)
	Piping Length		25 ft (7.5 m)		25 ft (7.5 m)	
Drawing No.			C: 3D143150A		C: 3D143150A	
Note(s)			SL: The quiet fan level of the airflow rate setting. External static pressure is changeable in 13 stages by remote controller. Air filter is not standard accessory, but please mount it in the duct system of the suction side. Select its dust collection efficiency (gravity method) 50% or more.			

Conversion Formulae
kcal/h = kW × 860
Btu/h = kW × 3412
cfm = m <sup>3</sup> /min × 35.3

Model	Indoor Unit		FDMQ15WVJU9		FDMQ18WVJU9	
	Outdoor Unit		RX15WWMVJU9		RX18WWMVJU9	
			Cooling	Heating	Cooling	Heating
Power Supply			1 ϕ, 208 - 230 V, 60 Hz		1 ϕ, 208 - 230 V, 60 Hz	
Capacity Rated (Min. - Max.)	Btu/h		14,400 (5,100 - 15,700)	18,000 (5,600 - 18,500)	17,600 (5,100 - 19,600)	21,600 (5,700 - 22,200)
Running Current (Rated)	A		7.25 - 6.56	8.72 - 7.89	9.16 - 8.28	10.41 - 9.41
Power Consumption (Rated)	W		1,440 - 1,440	1,758 - 1,758	1,872 - 1,872	2,110 - 2,110
Power Factor (Rated)	%		95.5 - 95.4	96.9 - 96.9	98.3 - 98.3	97.4 - 97.5
SEER2 / HSPF2			15.30	8.20	15.30	8.20
EER2 (Rated)	Btu/h-W		10.00	—	9.40	—
COP2 (Rated)	W/W		—	3.00	—	3.00
Piping Connections	Liquid	in. (mm)	ϕ 1/4 (6.4)		ϕ 1/4 (6.4)	
	Gas	in. (mm)	ϕ 1/2 (12.7)		ϕ 1/2 (12.7)	
	Drain	in. (mm)	I.D. ϕ 1 (25) / O.D. ϕ 1-1/4 (32)		I.D. ϕ 1 (25) / O.D. ϕ 1-1/4 (32)	
Heat Insulation			Both Liquid and Gas Pipes		Both Liquid and Gas Pipes	
Max. Interunit Piping Length	ft (m)		98-1/2 (30)		98-1/2 (30)	
Max. Interunit Height Difference	ft (m)		65-5/8 (20)		65-5/8 (20)	
Chargeless	ft (m)		32-3/4 (10)		32-3/4 (10)	
Amount of Additional Charge of Refrigerant	oz/ft (g/m)		0.21 (20)		0.21 (20)	
<b>Indoor Unit</b>		<b>FDMQ15WVJU9</b>		<b>FDMQ18WVJU9</b>		
Heat Exchanger	Rows x Stages, Fin per Inch		2 x 26, 18		3 x 26, 18	
	Fin Spec / Tube		Multi Slit Fin / ϕ 5 Hi-XA Tube		Multi Slit Fin / ϕ 5 Hi-XA Tube	
Airflow Rate	H / M / L	cfm	448 / 399 / 350	448 / 399 / 350	614 / 523 / 431	614 / 523 / 431
		m <sup>3</sup> /min	12.7 / 11.3 / 9.9	12.7 / 11.3 / 9.9	17.4 / 14.8 / 12.2	17.4 / 14.8 / 12.2
Fan Motor	H / M / L	rpm	926 / 822 / 717	926 / 822 / 717	1,023 / 870 / 717	1,023 / 870 / 717
	Motor Output	HP	0.31		0.31	
Fan	Type		Sirocco Fan		Sirocco Fan	
External Static Pressure		inH <sub>2</sub> O	Standard 0.20 (0.60 - 0.20)		Standard 0.20 (0.60 - 0.20)	
		Pa	Standard 50 (150 - 50)		Standard 50 (150 - 50)	
Running Current (Rated)	A		0.58 - 0.52	0.58 - 0.52	0.69 - 0.62	0.69 - 0.62
Power Consumption (Rated)	W		104 - 104	104 - 104	131 - 131	131 - 131
Power Factor (Rated)	%		85.8 - 87.1	85.8 - 87.1	91.2 - 92.2	91.2 - 92.2
Temperature Control			Microcomputer Control		Microcomputer Control	
Dimensions (H x W x D)	in. (mm)		9-5/8 x 39-3/8 x 31-1/2 (245 x 1,000 x 800)		9-5/8 x 39-3/8 x 31-1/2 (245 x 1,000 x 800)	
Packaged Dimensions (H x W x D)	in. (mm)		11-9/16 x 47-3/16 x 34-7/8 (293 x 1,199 x 886)		11-9/16 x 47-3/16 x 34-7/8 (293 x 1,199 x 886)	
Weight (Mass)	lbs (kg)		77 (35)		82 (37)	
Gross Weight (Gross Mass)	lbs (kg)		84 (38)		88 (40)	
Sound Pressure Level	dB(A)		34	34	35	35
Remote Controller (Option)	Wired		BRC1E73		BRC1E73	
	Wireless		BRC082A43		BRC082A43	
<b>Outdoor Unit</b>		<b>RX15WWMVJU9</b>		<b>RX18WWMVJU9</b>		
Casing Color			Ivory White		Ivory White	
Heat Exchanger	Fin Spec / Tube		Waffle Fin (PE) / ϕ 7 Hi-XSL Tube		Waffle Fin (PE) / ϕ 7 Hi-XSL Tube	
Fan Motor	Motor Output	HP	0.10		0.12	
Compressor	Type		Hermetically Sealed Swing Type		Hermetically Sealed Swing Type	
	Model		2YC36PXD		2YC36PXD	
Refrigerant Oil	Type		FVC50K		FVC50K	
	Charge	oz (L)	21.98 (0.650)		21.98 (0.650)	
Refrigerant	Type		R-410A		R-410A	
	Charge	lbs (kg)	2.49 (1.13)		2.49 (1.13)	
Airflow Rate	cfm (m <sup>3</sup> /min)		2,313 (65.5)	2,108 (59.7)	2,461 (69.7)	2,553 (72.3)
Fan	Type		Propeller		Propeller	
Running Current (Rated)	A		6.67 - 6.04	8.14 - 7.37	8.47 - 7.66	9.72 - 8.79
Power Consumption (Rated)	W		1,336 - 1,336	1,654 - 1,654	1,741 - 1,741	1,979 - 1,979
Power Factor (Rated)	%		96.3 - 96.2	97.7 - 97.6	98.8 - 98.8	97.9 - 97.9
Dimensions (H x W x D)	in. (mm)		28-15/16 x 34-1/4 x 12-5/8 (735 x 870 x 320)		28-15/16 x 34-1/4 x 12-5/8 (735 x 870 x 320)	
Packaged Dimensions (H x W x D)	in. (mm)		31-7/8 x 41-9/16 x 18-1/4 (810 x 1,056 x 464)		31-7/8 x 41-9/16 x 18-1/4 (810 x 1,056 x 464)	
Weight (Mass)	lbs (kg)		100 (45)		100 (45)	
Gross Weight (Gross Mass)	lbs (kg)		110 (50)		110 (50)	
Sound Pressure Level	dB(A)		50	51	54	55
Conditions Based on	Indoor		80.0°FDB (26.7°CDB) / 67.0°FWB (19.4°CWB)		80.0°FDB (26.7°CDB) / 67.0°FWB (19.4°CWB)	
	Outdoor		70.0°FDB (21.1°CDB) / 60.0°FWB (15.6°CWB)		70.0°FDB (21.1°CDB) / 60.0°FWB (15.6°CWB)	
	Piping Length		95.0°FDB (35.0°CDB) / 75.0°FWB (24.0°CWB)		47.0°FDB (8.3°CDB) / 43.0°FWB (6.1°CWB)	
Drawing No.			25 ft (7.5 m)		25 ft (7.5 m)	
Note(s)			C: 3D143151A		C: 3D143151A	
SL: The quiet fan level of the airflow rate setting. External static pressure is changeable in 11 stages by remote controller. Air filter is not standard accessory, but please mount it in the duct system of the suction side. Select its dust collection efficiency (gravity method) 50% or more.						

Conversion Formulae	
kcal/h = kW × 860	
Btu/h = kW × 3412	
cfm = m <sup>3</sup> /min × 35.3	

Model	Indoor Unit		FDMQ24WVJU9	
	Outdoor Unit		RX24WMVJU9	
		Cooling		Heating
Power Supply		1 $\phi$ , 208 - 230 V, 60 Hz		
Capacity Rated (Min. - Max.)	Btu/h	21,800 (5,500 - 23,000)		24,000 (6,400 - 26,600)
Running Current (Rated)	A	10.56 - 9.55		11.37 - 10.28
Power Consumption (Rated)	W	2,180 - 2,180		2,345 - 2,345
Power Factor (Rated)	%	99.2 - 99.2		99.2 - 99.2
SEER2 / HSPF2		15.20		8.10
EER2 (Rated)	Btu/h·W	10.00		—
COP2 (Rated)		—		3.00
Piping Connections	Liquid	in. (mm)	$\phi$ 1/4 (6.4)	
	Gas	in. (mm)	$\phi$ 5/8 (15.9)	
	Drain	in. (mm)	I.D. $\phi$ 1 (25) / O.D. $\phi$ 1-1/4 (32)	
Heat Insulation		Both Liquid and Gas Pipes		
Max. Interunit Piping Length	ft (m)	98-1/2 (30)		
Max. Interunit Height Difference	ft (m)	65-5/8 (20)		
Chargeless	ft (m)	32-3/4 (10)		
Amount of Additional Charge of Refrigerant	oz/ft (g/m)	0.21 (20)		
Indoor Unit		FDMQ24WVJU9		
Heat Exchanger	Rows $\times$ Stages, Fin per Inch	3 $\times$ 26, 18		
	Fin Spec / Tube	Multi Slit Fin / $\phi$ 5 Hi-XA Tube		
Airflow Rate	H / M / L	cfm	731 / 621 / 512	731 / 621 / 512
		m <sup>3</sup> /min	20.7 / 17.6 / 14.5	20.7 / 17.6 / 14.5
Fan Motor	H / M / L	rpm	1,119 / 951 / 783	1,119 / 951 / 783
	Motor Output	HP	0.31	
Fan	Type	Sirocco Fan		
External Static Pressure	inH <sub>2</sub> O	Standard 0.20 (0.60 - 0.20)		
	Pa	Standard 50 (150 - 50)		
Running Current (Rated)	A	0.82 - 0.74		0.82 - 0.74
Power Consumption (Rated)	W	167 - 167		167 - 167
Power Factor (Rated)	%	97.8 - 97.5		97.8 - 97.5
Temperature Control		Microcomputer Control		
Dimensions (H $\times$ W $\times$ D)	in. (mm)	9-5/8 $\times$ 39-3/8 $\times$ 31-1/2 (245 $\times$ 1,000 $\times$ 800)		
Packaged Dimensions (H $\times$ W $\times$ D)	in. (mm)	11-9/16 $\times$ 47-3/16 $\times$ 34-7/8 (293 $\times$ 1,199 $\times$ 886)		
Weight (Mass)	lbs (kg)	82 (37)		
Gross Weight (Gross Mass)	lbs (kg)	88 (40)		
Sound Pressure Level	dB(A)	40		40
Remote Controller (Option)	Wired	BRC1E73		
	Wireless	BRC082A43		
Outdoor Unit		RX24WMVJU9		
Casing Color		Ivory White		
Heat Exchanger	Fin Spec / Tube	Waffle Fin (PE) / $\phi$ 7 Hi-XSL Tube		
Fan Motor	Motor Output	HP	0.12	
Compressor	Type	Hermetically Sealed Swing Type		
	Model	2YC36PXD		
Refrigerant Oil	Type	FVC50K		
	Charge	oz (L)	21.98 (0.650)	
Refrigerant	Type	R-410A		
	Charge	lbs (kg)	3.20 (1.45)	
Airflow Rate	cfm (m <sup>3</sup> /min)	2,641 (74.8)		2,641 (74.8)
Fan	Type	Propeller		
Running Current (Rated)	A	9.74 - 8.81		10.55 - 9.54
Power Consumption (Rated)	W	2,013 - 2,013		2,178 - 2,178
Power Factor (Rated)	%	99.4 - 99.3		99.3 - 99.3
Dimensions (H $\times$ W $\times$ D)	in. (mm)	28-15/16 $\times$ 34-1/4 $\times$ 12-5/8 (735 $\times$ 870 $\times$ 320)		
Packaged Dimensions (H $\times$ W $\times$ D)	in. (mm)	31-7/8 $\times$ 41-9/16 $\times$ 18-1/4 (810 $\times$ 1,056 $\times$ 464)		
Weight (Mass)	lbs (kg)	109 (50)		
Gross Weight (Gross Mass)	lbs (kg)	120 (54)		
Sound Pressure Level	dB(A)	56		58
Conditions Based on	Indoor	80.0°FDB (26.7°CDB) / 67.0°FWB (19.4°CWB)		70.0°FDB (21.1°CDB) / 60.0°FWB (15.6°CWB)
	Outdoor	95.0°FDB (35.0°CDB) / 75.0°FWB (24.0°CWB)		47.0°FDB (8.3°CDB) / 43.0°FWB (6.1°CWB)
	Piping Length	25 ft (7.5 m)		
Drawing No.	C: 3D143151A			
Note(s)	SL: The quiet fan level of the airflow rate setting. External static pressure is changeable in 11 stages by remote controller. Air filter is not standard accessory, but please mount it in the duct system of the suction side. Select its dust collection efficiency (gravity method) 50% or more.			

Conversion Formulae	
kcal/h = kW $\times$ 860	
Btu/h = kW $\times$ 3412	
cfm = m <sup>3</sup> /min $\times$ 35.3	

# 1.3 Ceiling Cassette Type

Model	Indoor Unit		FFQ09W2VJU9		FFQ12W2VJU9	
	Outdoor Unit		RX09WMVJU9		RX12WMVJU9	
			Cooling	Heating	Cooling	Heating
Power Supply			1 $\phi$ , 208 - 230 V, 60 Hz		1 $\phi$ , 208 - 230 V, 60 Hz	
Capacity Rated (Min. - Max.)	Btu/h		9,100 (4,600 - 11,000)	10,000 (4,600 - 14,000)	10,800 (4,600 - 13,300)	13,500 (4,600 - 16,800)
Running Current (Rated)	A		3.94 - 3.56	3.74 - 3.38	5.01 - 4.53	5.45 - 4.93
Power Consumption (Rated)	W		758 - 758	698 - 698	939 - 939	1,081 - 1,081
Power Factor (Rated)	%		92.5 - 92.5	89.7 - 89.9	90.1 - 90.1	95.4 - 95.4
SEER2 / HSPF2			19.80	9.40	19.50	9.00
EER2 (Rated)	Btu/h·W		12.00	—	11.50	—
COP2 (Rated)	W/W		—	4.20	—	3.66
Piping Connections	Liquid	in. (mm)	$\phi$ 1/4 (6.4)		$\phi$ 1/4 (6.4)	
	Gas	in. (mm)	$\phi$ 3/8 (9.5)		$\phi$ 3/8 (9.5)	
	Drain	in. (mm)	VP20 (O.D. $\phi$ 1-1/32 (26))		VP20 (O.D. $\phi$ 1-1/32 (26))	
Heat Insulation			Both Liquid and Gas Pipes		Both Liquid and Gas Pipes	
Max. Interunit Piping Length	ft (m)		65-5/8 (20)		65-5/8 (20)	
Max. Interunit Height Difference	ft (m)		49-1/4 (15)		49-1/4 (15)	
Chargeless	ft (m)		32-3/4 (10)		32-3/4 (10)	
Amount of Additional Charge of Refrigerant	oz/ft (g/m)		0.21 (20)		0.21 (20)	
<b>Indoor Unit</b>		<b>FFQ09W2VJU9</b>		<b>FFQ12W2VJU9</b>		
Decoration Panel (1)	Model (Color)		BYFQ60B3W1 (White)		BYFQ60B3W1 (White)	
	Dimensions (H x W x D)	in. (mm)	2-3/16 x 27-9/16 x 27-9/16 (55 x 700 x 700)		2-3/16 x 27-9/16 x 27-9/16 (55 x 700 x 700)	
	Weight (Mass)	lbs (kg)	6.0 (2.7)		6.0 (2.7)	
Decoration Panel (2)	Model (Color)		BYFQ60C2W1W (White) / BYFQ60C2W1S (Silver)		BYFQ60C2W1W (White) / BYFQ60C2W1S (Silver)	
	Dimensions (H x W x D)	in. (mm)	1-13/16 x 24-7/16 x 24-7/16 (46 x 620 x 620)		1-13/16 x 24-7/16 x 24-7/16 (46 x 620 x 620)	
	Weight (Mass)	lbs (kg)	6.2 (2.8)		6.2 (2.8)	
Heat Exchanger	Rows x Stages, Fin per Inch		2 x 16, 21		2 x 16, 21	
	Fin Spec / Tube		Slit Fin / $\phi$ 5 Hi-XA Tube		Slit Fin / $\phi$ 5 Hi-XA Tube	
Airflow Rate	H / M / L	cfm	378 / 339 / 268	399 / 357 / 282	406 / 353 / 268	427 / 371 / 282
		m <sup>3</sup> /min	10.7 / 9.6 / 7.6	11.3 / 10.1 / 8.0	11.5 / 10.0 / 7.6	12.1 / 10.5 / 8.0
Fan	Type / Speed		Turbo Fan / 3 Steps		Turbo Fan / 3 Steps	
Running Current (Rated)	A		0.23 - 0.21	0.23 - 0.21	0.27 - 0.24	0.27 - 0.24
Power Consumption (Rated)	W		23 - 23	23 - 23	27 - 27	27 - 27
Power Factor (Rated)	%		48.1 - 47.6	48.1 - 47.6	48.1 - 48.9	48.1 - 48.9
Temperature Control			Microcomputer Control		Microcomputer Control	
Dimensions (H x W x D)	in. (mm)		10-1/4 x 22-5/8 x 22-5/8 (260 x 575 x 575)		10-1/4 x 22-5/8 x 22-5/8 (260 x 575 x 575)	
Packaged Dimensions (H x W x D)	in. (mm)		11 x 27 x 23-1/2 (280 x 686 x 597)		11 x 27 x 23-1/2 (280 x 686 x 597)	
Weight (Mass)	lbs (kg)		36 (16)		36 (16)	
Gross Weight (Gross Mass)	lbs (kg)		39 (17)		39 (17)	
Sound Pressure Level	H / M / L	dB(A)	38 / 35 / 29		39 / 36 / 30	
			38 / 35 / 29		39 / 36 / 30	
Remote Controller (Option)	Wired		BRC1E73		BRC1E73	
	Wireless		BRC082A41W / BRC082A42W / BRC082A42S		BRC082A41W / BRC082A42W / BRC082A42S	
<b>Outdoor Unit</b>		<b>RX09WMVJU9</b>		<b>RX12WMVJU9</b>		
Casing Color			Ivory White		Ivory White	
Heat Exchanger	Fin Spec / Tube		Waffle Fin (PE) / $\phi$ 7 Hi-XSL Tube		Waffle Fin (PE) / $\phi$ 7 Hi-XSL Tube	
Fan Motor	Motor Output	HP	0.03		0.03	
Compressor	Type		Hermetically Sealed Swing Type		Hermetically Sealed Swing Type	
	Model		1YC23AUXD		1YC23AUXD	
Refrigerant Oil	Type		FVC50K		FVC50K	
	Charge	oz (L)	12.68 (0.375)		12.68 (0.375)	
Refrigerant	Type		R-410A		R-410A	
	Charge	lbs (kg)	2.09 (0.95)		2.09 (0.95)	
Airflow Rate	cfm (m <sup>3</sup> /min)		985 (27.9)	1,144 (32.4)	1,105 (31.3)	1,144 (32.4)
Fan	Type		Propeller		Propeller	
Running Current (Rated)	A		3.71 - 3.35	3.51 - 3.17	4.74 - 4.29	5.18 - 4.69
Power Consumption (Rated)	W		735 - 735	675 - 675	912 - 912	1,054 - 1,054
Power Factor (Rated)	%		95.2 - 95.4	92.5 - 92.6	92.5 - 92.4	97.8 - 97.7
Dimensions (H x W x D)	in. (mm)		21-5/8 x 26-9/16 x 11-3/16 (550 x 675 x 284)		21-5/8 x 26-9/16 x 11-3/16 (550 x 675 x 284)	
Packaged Dimensions (H x W x D)	in. (mm)		23-13/16 x 31-7/16 x 14-11/16 (605 x 798 x 373)		23-13/16 x 31-7/16 x 14-11/16 (605 x 798 x 373)	
Weight (Mass)	lbs (kg)		63 (29)		63 (29)	
Gross Weight (Gross Mass)	lbs (kg)		68 (31)		68 (31)	
Sound Pressure Level	dB(A)		46	50	49	51
Conditions Based on	Indoor		80.0°FDB (26.7°CDB) / 67.0°FWB (19.4°CWB)		80.0°FDB (26.7°CDB) / 67.0°FWB (19.4°CWB)	
	Outdoor		95.0°FDB (35.0°CDB) / 75.0°FWB (24.0°CWB)		95.0°FDB (35.0°CDB) / 75.0°FWB (24.0°CWB)	
	Piping Length		25 ft (7.5 m)		25 ft (7.5 m)	
Drawing No.			C: 3D143143A		C: 3D143143A	
Note(s)			SL: The quiet fan level of the airflow rate setting.			

Conversion Formulae
kcal/h = kW x 860
Btu/h = kW x 3412
cfm = m <sup>3</sup> /min x 35.3



Model	Indoor Unit		FFQ15W2VJU9		FFQ18W2VJU9	
	Outdoor Unit		RX15WMVJU9		RX18WMVJU9	
			Cooling	Heating	Cooling	Heating
Power Supply			1 $\phi$ , 208 - 230 V, 60 Hz		1 $\phi$ , 208 - 230 V, 60 Hz	
Capacity Rated (Min. - Max.)	Btu/h		14,400 (5,100 - 16,200)	16,200 (5,200 - 16,300)	17,400 (5,100 - 18,800)	21,600 (5,400 - 21,800)
Running Current (Rated)	A		6.34 - 5.73	6.80 - 6.15	7.74 - 7.00	10.70 - 9.68
Power Consumption (Rated)	W		1,252 - 1,252	1,349 - 1,349	1,513 - 1,513	2,110 - 2,110
Power Factor (Rated)	%		94.9 - 95.0	95.4 - 95.4	94.0 - 94.0	94.8 - 94.8
SEER2 / HSPF2			19.60	8.80	18.20	8.40
EER2 (Rated)	Btu/h-W		11.50	—	11.50	—
COP2 (Rated)	W/W		—	3.52	—	3.00
Piping Connections	Liquid	in. (mm)	$\phi$ 1/4 (6.4)		$\phi$ 1/4 (6.4)	
	Gas	in. (mm)	$\phi$ 1/2 (12.7)		$\phi$ 1/2 (12.7)	
	Drain	in. (mm)	VP20 (O.D. $\phi$ 1-1/32 (26))		VP20 (O.D. $\phi$ 1-1/32 (26))	
Heat Insulation			Both Liquid and Gas Pipes		Both Liquid and Gas Pipes	
Max. Interunit Piping Length	ft (m)		98-1/2 (30)		98-1/2 (30)	
Max. Interunit Height Difference	ft (m)		65-5/8 (20)		65-5/8 (20)	
Chargeless	ft (m)		32-3/4 (10)		32-3/4 (10)	
Amount of Additional Charge of Refrigerant	oz/ft (g/m)		0.21 (20)		0.21 (20)	
<b>Indoor Unit</b>			<b>FFQ15W2VJU9</b>		<b>FFQ18W2VJU9</b>	
Decoration Panel (1)	Model (Color)		BYFQ60B3W1 (White)		BYFQ60B3W1 (White)	
	Dimensions (H x W x D)	in. (mm)	2-3/16 x 27-9/16 x 27-9/16 (55 x 700 x 700)		2-3/16 x 27-9/16 x 27-9/16 (55 x 700 x 700)	
	Weight (Mass)	lbs (kg)	6.0 (2.7)		6.0 (2.7)	
Decoration Panel (2)	Model (Color)		BYFQ60C2W1W (White) / BYFQ60C2W1S (Silver)		BYFQ60C2W1W (White) / BYFQ60C2W1S (Silver)	
	Dimensions (H x W x D)	in. (mm)	1-13/16 x 24-7/16 x 24-7/16 (46 x 620 x 620)		1-13/16 x 24-7/16 x 24-7/16 (46 x 620 x 620)	
	Weight (Mass)	lbs (kg)	6.2 (2.8)		6.2 (2.8)	
Heat Exchanger	Rows x Stages, Fin per Inch		2 x 16, 21		2 x 16, 21	
	Fin Spec / Tube		Slit Fin / $\phi$ 5 Hi-XA Tube		Slit Fin / $\phi$ 5 Hi-XA Tube	
Airflow Rate	H / M / L	cfm	420 / 367 / 293	441 / 385 / 307	448 / 378 / 275	498 / 420 / 307
		m <sup>3</sup> /min	11.9 / 10.4 / 8.3	12.5 / 10.9 / 8.7	12.7 / 10.7 / 7.8	14.1 / 11.9 / 8.7
Fan	Type / Speed		Turbo Fan / 3 Steps		Turbo Fan / 3 Steps	
Running Current (Rated)	A		0.29 - 0.26	0.29 - 0.26	0.52 - 0.47	0.52 - 0.47
Power Consumption (Rated)	W		28 - 28	28 - 28	51 - 51	51 - 51
Power Factor (Rated)	%		46.4 - 46.8	46.4 - 46.8	47.2 - 47.2	47.2 - 47.2
Temperature Control			Microcomputer Control		Microcomputer Control	
Dimensions (H x W x D)	in. (mm)		10-1/4 x 22-5/8 x 22-5/8 (260 x 575 x 575)		10-1/4 x 22-5/8 x 22-5/8 (260 x 575 x 575)	
Packaged Dimensions (H x W x D)	in. (mm)		11 x 27 x 23-1/2 (280 x 686 x 597)		11 x 27 x 23-1/2 (280 x 686 x 597)	
Weight (Mass)	lbs (kg)		36 (16)		39 (17.5)	
Gross Weight (Gross Mass)	lbs (kg)		39 (17)		42 (19)	
Sound Pressure Level	H / M / L	dB(A)	40 / 37 / 31	40 / 37 / 31	44 / 40 / 32	44 / 40 / 32
Remote Controller (Option)	Wired		BRC1E73		BRC1E73	
	Wireless		BRC082A41W / BRC082A42W / BRC082A42S		BRC082A41W / BRC082A42W / BRC082A42S	
<b>Outdoor Unit</b>			<b>RX15WMVJU9</b>		<b>RX18WMVJU9</b>	
Casing Color			Ivory White		Ivory White	
Heat Exchanger	Fin Spec / Tube		Waffle Fin (PE) / $\phi$ 7 Hi-XSL Tube		Waffle Fin (PE) / $\phi$ 7 Hi-XSL Tube	
Fan Motor	Motor Output	HP	0.10		0.12	
Compressor	Type		Hermetically Sealed Swing Type		Hermetically Sealed Swing Type	
	Model		2YC36PXD		2YC36PXD	
Refrigerant Oil	Type		FVC50K		FVC50K	
	Charge	oz (L)	21.98 (0.650)		21.98 (0.650)	
Refrigerant	Type		R-410A		R-410A	
	Charge	lbs (kg)	2.49 (1.13)		2.49 (1.13)	
Airflow Rate		cfm (m <sup>3</sup> /min)	2,313 (65.5)	2,108 (59.7)	2,461 (69.7)	2,553 (72.3)
Fan	Type		Propeller		Propeller	
Running Current (Rated)	A		6.05 - 5.47	6.51 - 5.89	7.22 - 6.53	10.18 - 9.21
Power Consumption (Rated)	W		1,224 - 1,224	1,321 - 1,321	1,462 - 1,462	2,059 - 2,059
Power Factor (Rated)	%		97.3 - 97.3	97.6 - 97.5	97.4 - 97.3	97.2 - 97.2
Dimensions (H x W x D)	in. (mm)		28-15/16 x 34-1/4 x 12-5/8 (735 x 870 x 320)		28-15/16 x 34-1/4 x 12-5/8 (735 x 870 x 320)	
Packaged Dimensions (H x W x D)	in. (mm)		31-7/8 x 41-9/16 x 18-1/4 (810 x 1,056 x 464)		31-7/8 x 41-9/16 x 18-1/4 (810 x 1,056 x 464)	
Weight (Mass)	lbs (kg)		100 (45)		100 (45)	
Gross Weight (Gross Mass)	lbs (kg)		110 (50)		110 (50)	
Sound Pressure Level		dB(A)	50	51	54	55
Conditions Based on	Indoor		80.0°FDB (26.7°CDB) / 67.0°FWB (19.4°CWB)	70.0°FDB (21.1°CDB) / 60.0°FWB (15.6°CWB)	80.0°FDB (26.7°CDB) / 67.0°FWB (19.4°CWB)	70.0°FDB (21.1°CDB) / 60.0°FWB (15.6°CWB)
	Outdoor		95.0°FDB (35.0°CDB) / 75.0°FWB (24.0°CWB)	47.0°FDB (8.3°CDB) / 43.0°FWB (6.1°CWB)	95.0°FDB (35.0°CDB) / 75.0°FWB (24.0°CWB)	47.0°FDB (8.3°CDB) / 43.0°FWB (6.1°CWB)
	Piping Length		25 ft (7.5 m)		25 ft (7.5 m)	
Drawing No.			C: 3D143144A		C: 3D143144A	
Note(s)			SL: The quiet fan level of the airflow rate setting.			

Conversion Formulae
kcal/h = kW x 860
Btu/h = kW x 3412
cfm = m <sup>3</sup> /min x 35.3

---

# Part 3

# Printed Circuit Board

# Connector Wiring Diagram

1. Indoor Unit.....	23
1.1 FTXR09/12/18WVJUW(S)9.....	23
1.2 FDMQ09/12/15/18/24WVJU9.....	25
1.3 FFQ09/12/15/18W2VJU9.....	27
2. Sensor Kit for FFQ Series.....	28
2.1 BRYQ60A2W(S).....	28
3. Wired Remote Controller.....	29
3.1 BRC1E73.....	29
4. Wireless Remote Controller Receiver for FDMQ Series.....	30
4.1 BRC082A43.....	30
5. Wireless Remote Controller Kit for FFQ Series.....	31
5.1 BRC082A41W, BRC082A42W(S).....	31
6. Outdoor Unit.....	32
6.1 RX09/12WMVJU9.....	32
6.2 RX15/18/24WMVJU9.....	34



# 1. Indoor Unit

## 1.1 FTXR09/12/18WVJUW(S)9

### Control PCB (A1P)

- |     |            |   |
|-----|------------|---|
| 1)  | S21        | Connector for centralized control (HA)  |
| 2)  | S25        | Connector for INTELLIGENT EYE sensor PCB (A3P)  |
| 3)  | S32        | Wire harness for indoor heat exchanger thermistor (R2T)   |
| 4)  | S41        | Connector for swing motors  |
| 5)  | S42        | Wire harness for reduction motor (front panel mechanism) and limit switch                               |
| 6)  | S46        | Connector for display/signal receiver PCB (A2P)   |
| 7)  | S200       | Connector for DC fan motor  |
| 8)  | H1, H2, H3 | Wire harness for terminal strip (indoor - outdoor transmission)   |
| 9)  | FG         | Wire harness for terminal strip (frame ground)  |
| 10) | JB         | Jumper for fan speed setting when compressor stops for thermostat OFF<br>Refer to page 211 for details. |
| 11) | JC         | Jumper for power failure recovery function (auto-restart)<br>Refer to page 211 for details.             |
| 12) | LED A      | LED for service monitor (green)   |
| 13) | F1U, F2U   | Fuse (3.15 A, 250 V)  |
| 14) | V1         | Varistor  |

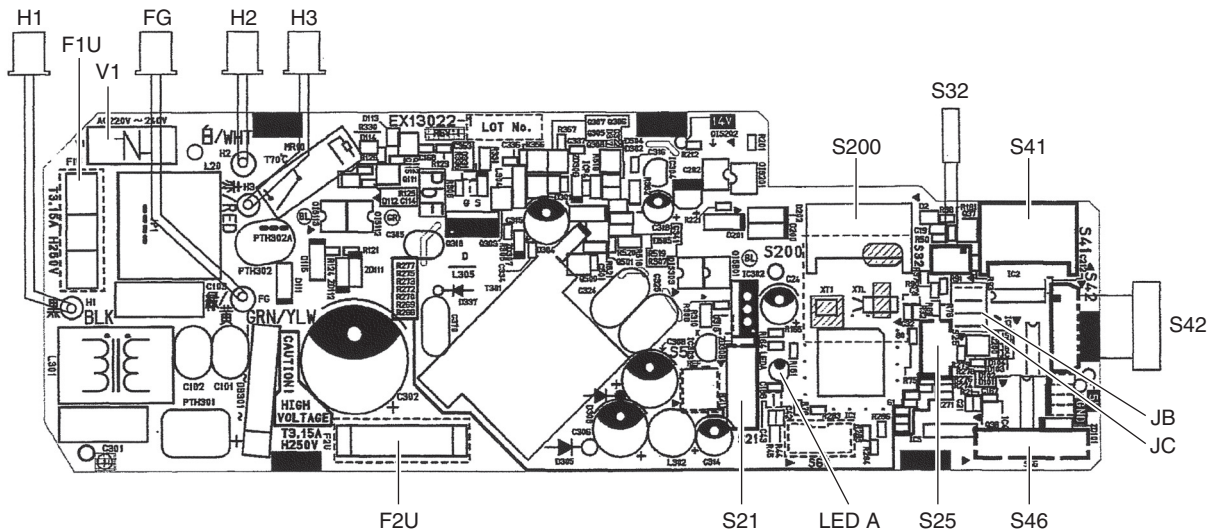

2P357399-6



### Caution

**Replace the PCB if you cut a jumper unintentionally.**

Jumpers are necessary for electronic circuit. Improper operation may occur if you cut any of them.

**Display/Signal Receiver PCB (A2P)**

- 1) S51 Connector for control PCB (A1P)
- 2) S52 Connector for room temperature thermistor (R1T)
- 3) S1W Indoor unit **ON/OFF** switch
- 4) H1P LED for operation (multi-color)
- 5) H2P LED for INTELLIGENT EYE (green)
- 6) JA Address setting jumper  
Refer to page 210 for details.

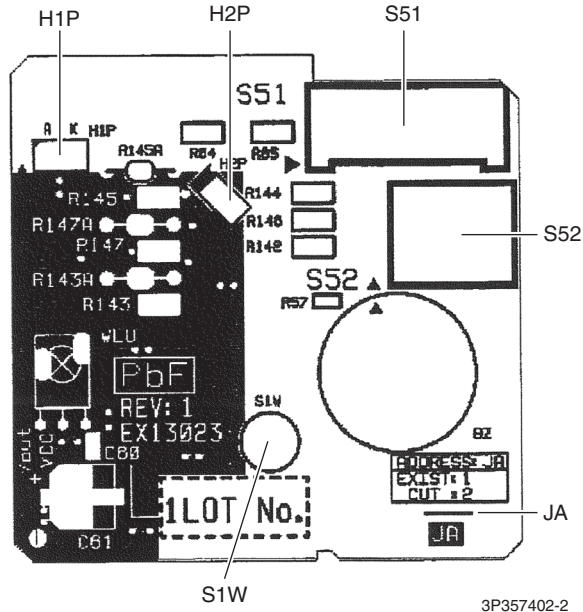

**Caution** Replace the PCB if you cut a jumper unintentionally.  
Jumpers are necessary for electronic circuit. Improper operation may occur if you cut any of them.

**INTELLIGENT EYE Sensor PCB (A3P)**

- 1) S36 Connector for control PCB (A1P)

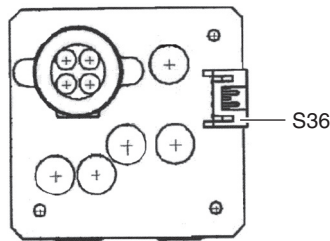

# 1.2 FDMQ09/12/15/18/24WVJU9

## Control PCB (A1P)

- 1) X15A Connector for float switch
- 2) X16A Connector for room temperature thermistor (suction air thermistor) (R1T)
- 3) X17A, X18A Connector for indoor heat exchanger thermistor (R2T, R3T)
- 4) X25A Connector for drain pump motor
- 5) X27A Connector for terminal block (for power supply)
- 6) X28A Connector for power supply wiring (option)
- 7) X30A Connector for terminal block (for wired remote controller)
- 8) X33A Connector for wiring (option)
- 9) X35A Connector for wiring adaptor (option)
- 10) X70A Connector for indoor fan PCB (A2P)
- 11) F1U Fuse (3.15 A, 250 V)
- 12) HAP LED for service monitor (green)
- 13) DS1 DIP switch for emergency

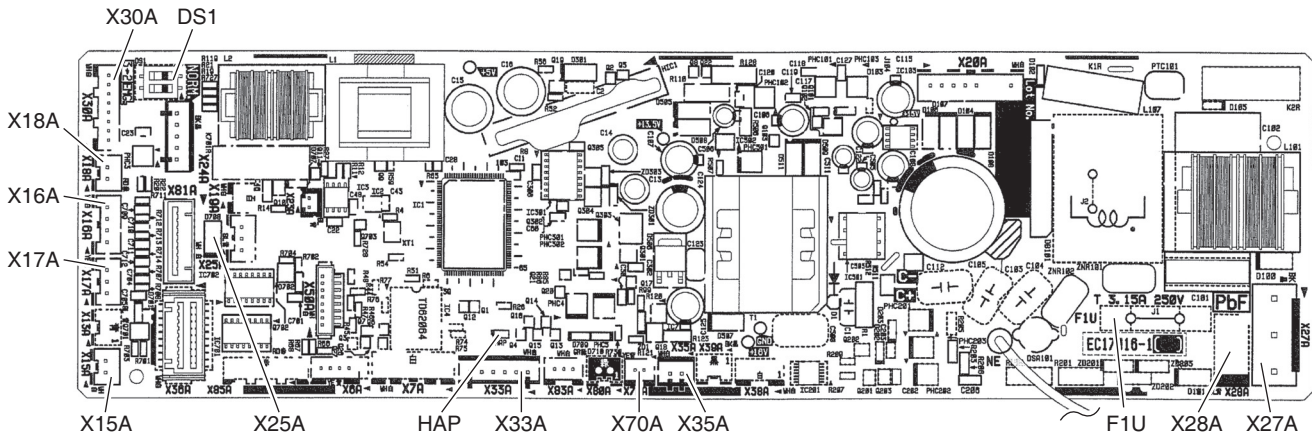

2P486802-3



## 1.3 FFQ09/12/15/18W2VJU9

### Control PCB (A1P)

- |     |            |   |
|-----|------------|---|
| 1)  | X15A       | Connector for float switch  |
| 2)  | X16A       | Connector for room temperature thermistor (suction air thermistor)                        |
| 3)  | X17A, X18A | Connector for indoor heat exchanger thermistor  |
| 4)  | X20A       | Connector for DC fan motor  |
| 5)  | X24A       | Connector for transmitter board<br>(when the wireless remote controller (option) is used) |
| 6)  | X25A       | Connector for drain pump motor  |
| 7)  | X27A       | Connector for terminal block (for inter-unit wiring)                                      |
| 8)  | X30A       | Connector for terminal block (for wired remote controller)                                |
| 9)  | X33A       | Connector for adaptor for wiring (option)   |
| 10) | X35A       | Connector for wiring adaptor for electrical appendices (option)                           |
| 11) | X36A       | Connector for swing motors on decoration panel (option)                                   |
| 12) | X80A       | Connector for decoration panel (BYFQ60B3W1) (option)                                      |
| 13) | X81A       | Connector for sensor kit (BRYQ60A2W(S)) (option)  |
| 14) | HAP        | LED for service monitor (green)   |
| 15) | DS1        | DIP switch for emergency  |
| 16) | F1U        | Fuse (5A, 250V)   |

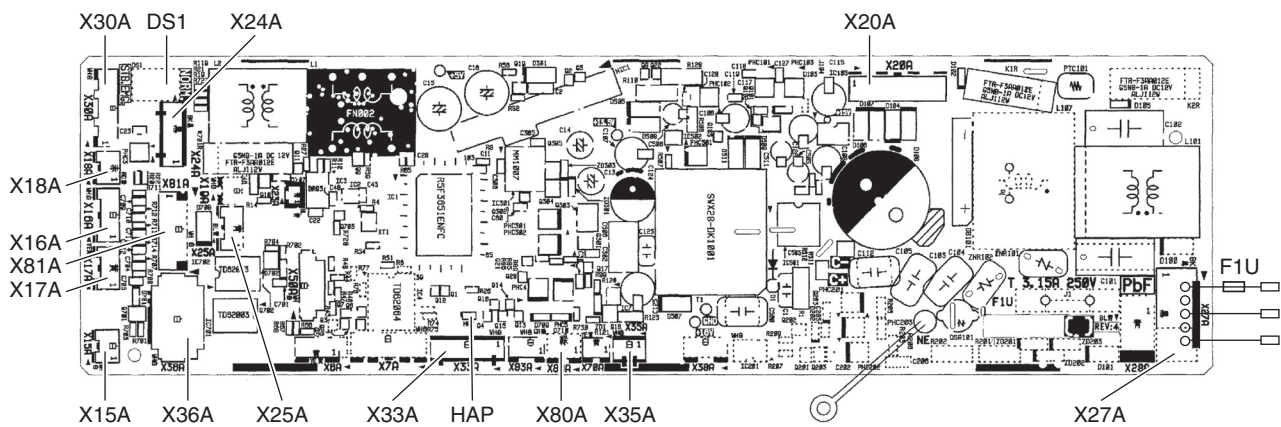

2P452045-1

## 2. Sensor Kit for FFQ Series

### 2.1 BRYQ60A2W(S)

#### Outline

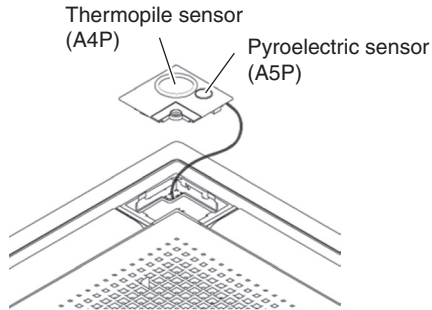

(R25074)

#### Thermopile Sensor (A4P)

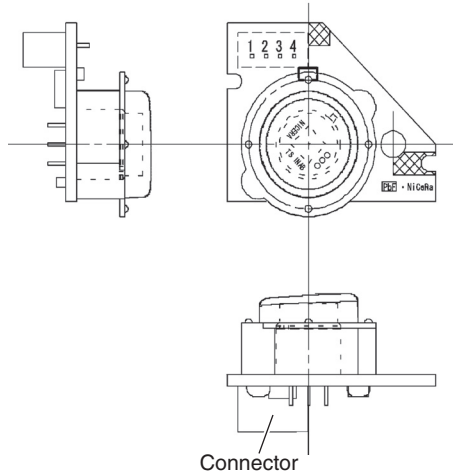

3P262610-1

#### Pyroelectric Sensor (A5P)

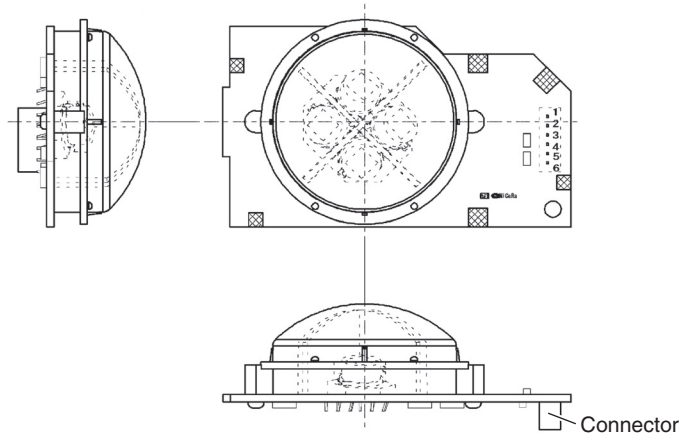

3P262611-1



# 3. Wired Remote Controller

## 3.1 BRC1E73

**Wired Remote Controller PCB**

- 1) P1, P2 Terminal for indoor unit
- 2) R4T Room temperature thermistor

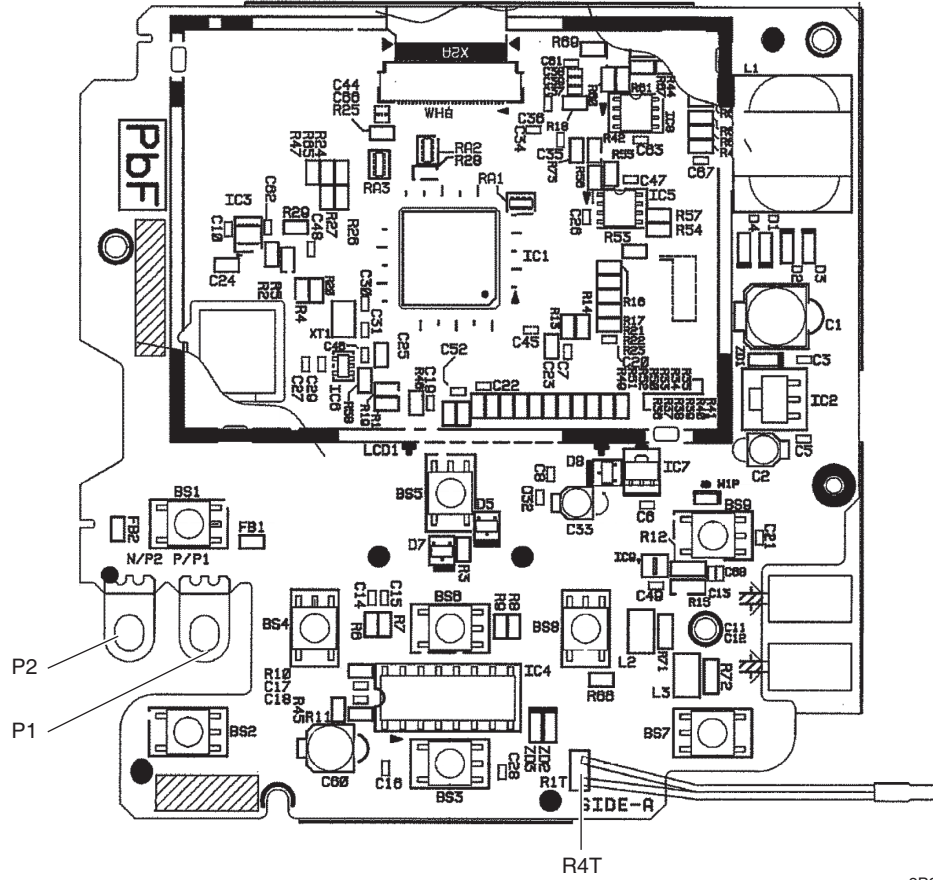

2P619817-7

# 4. Wireless Remote Controller Receiver for FDMQ Series

## 4.1 BRC082A43

**Wired Remote Controller PCB**

- 1) SS1 MAIN/SUB setting switch  
Refer to page 218 for details.
- 2) SS2 Address setting switch  
Refer to page 218 for details.
- 3) P1, P2 Terminal for indoor unit control PCB (A1P)

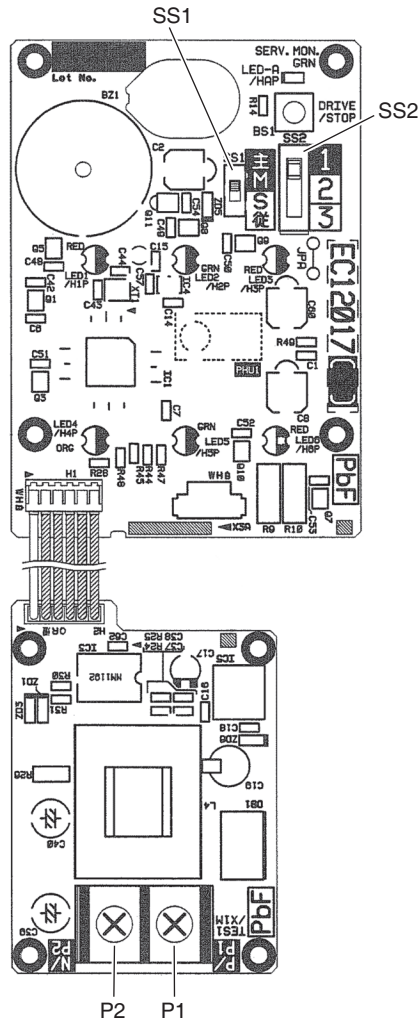

3P431101-2



# 5. Wireless Remote Controller Kit for FFQ Series

## 5.1 BRC082A41W, BRC082A42W(S)

### Transmitter Board (A2P)

- 1) X1A Connector for receiver (A3P)
- 2) X2A Connector for control PCB (A1P)
- 3) SS1 MAIN/SUB setting switch  
Refer to page 221 for details.
- 4) SS2 Address setting switch  
Refer to page 221 for details.

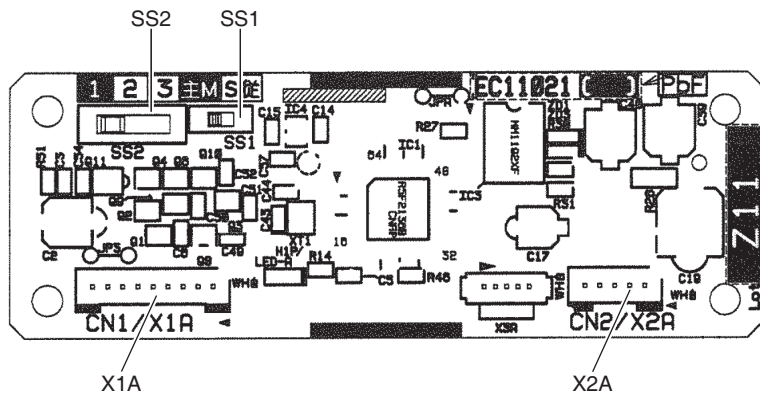

### Receiver (A3P)

- 1) X1A Connector for transmitter board (A2P)
- 2) BS1 Emergency operation switch
- 3) LED1 (H1P) LED for operation (red)
- 4) LED2 (H2P) LED for timer (green)
- 5) LED3 (H3P) LED for filter cleaning sign (red)
- 6) LED4 (H4P) LED for defrost operation (orange)

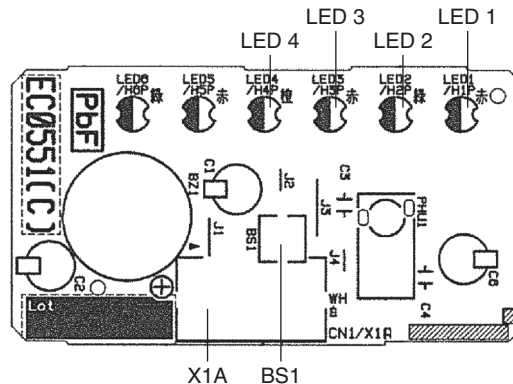

★ LED5 and LED6 do not function.



Note

The symbols in the parenthesis are the names on the appropriate wiring diagram.

## 6. Outdoor Unit

### 6.1 RX09/12WMVJU9

#### Main PCB (PCB1)

1)	S20	Connector for electronic expansion valve coil
2)	S30	Connector for compressor
3)	S40	Connector for overload protector and high pressure switch
4)	S71	Connector for DC fan motor
5)	S80	Connector for four way valve coil
6)	S90	Connector for thermistors (outdoor temperature, outdoor heat exchanger, discharge pipe)
7)	HL1, HN1, S	Wire harness for terminal block
8)	E1, E2	Wire harness for ground wire
9)	HR1, HR2	Wire harness for reactor
10)	FU1, FU2	Fuse (3.15 A, 250 V)
11)	FU3	Fuse (20 A, 250 V)
12)	J5	Jumper for warmer airflow setting Refer to page 225 for details.
13)	J6	Jumper for facility setting Refer to page 224 for details.
14)	J9	Jumper for drain pan heater Refer to page 226 for details.
15)	LED A	LED for service monitor (green)
16)	V2, V3, V150	Varistor

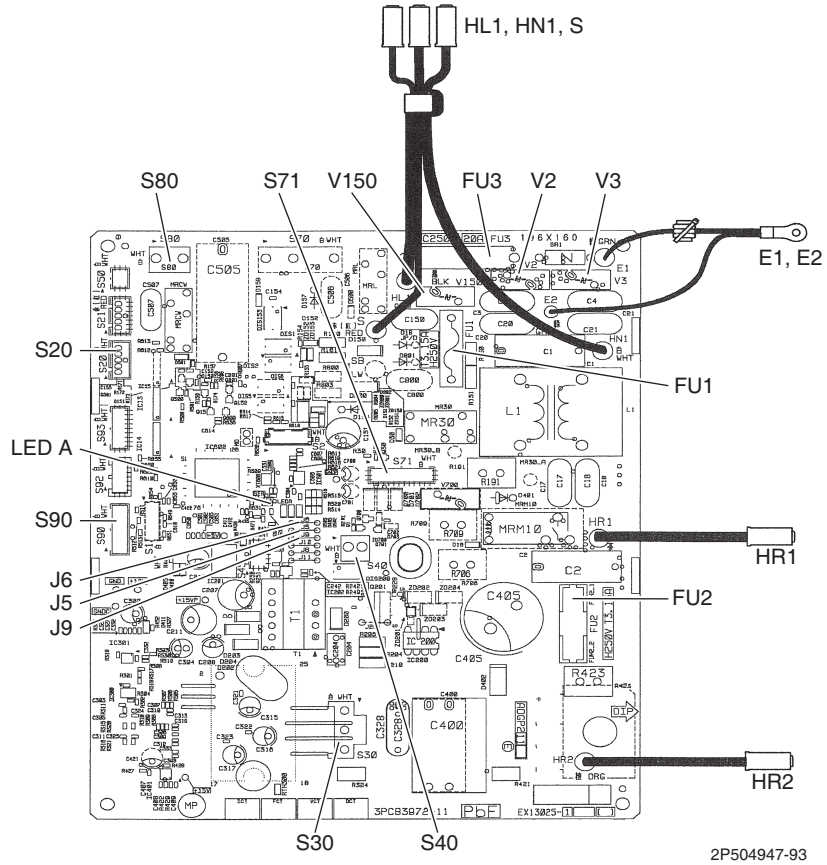

 **Caution**

**Replace the PCB if you cut a jumper unintentionally.**

Jumpers are necessary for electronic circuit. Improper operation may occur if you cut any of them.

## 6.2 RX15/18/24WMVJU9

---

### Main PCB

1)	S20	Connector for electronic expansion valve coil
2)	S40	Connector for overload protector and high pressure switch
3)	S70	Connector for DC fan motor
4)	S80	Connector for four way valve coil
5)	S90	Connector for thermistors (outdoor temperature, outdoor heat exchanger, discharge pipe)
6)	HL1, HN1, S	Wire harness for terminal block
7)	E1, E2	Wire harness for ground
8)	U, V, W	Wire harness for compressor
9)	FU1, FU2	Fuse (3.15 A, 250 V)
10)	FU3	Fuse (30 A, 250 V)
11)	J5	Jumper for warmer airflow setting Refer to page 225 for details.
12)	J6	Jumper for facility setting Refer to page 224 for details.
13)	J9	Jumper for drain pan heater Refer to page 226 for details.
14)	LED A	LED for service monitor (green)
15)	V1, V2, V3	Varistor

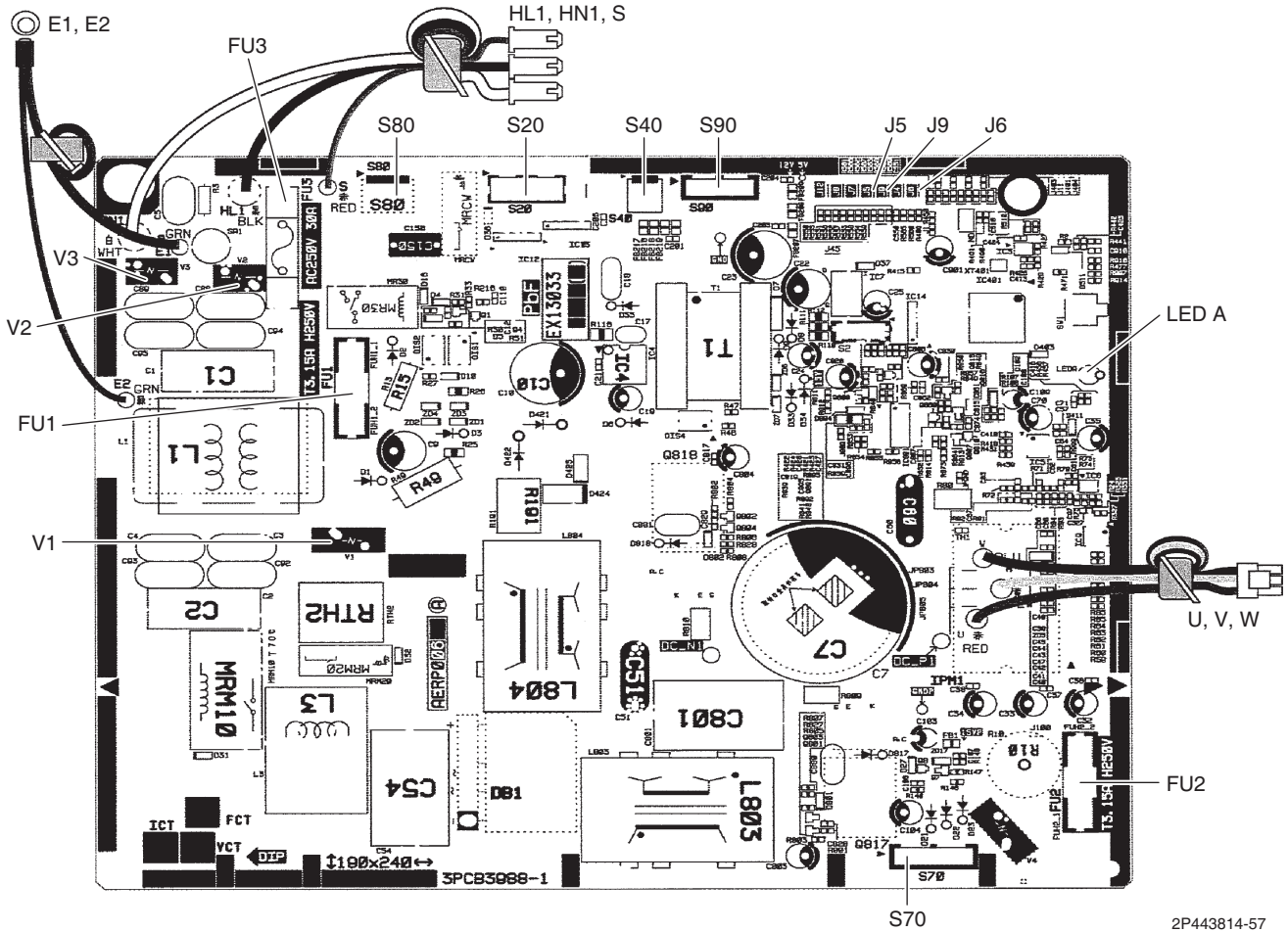

**Caution**

**Replace the PCB if you cut a jumper unintentionally.**

Jumpers are necessary for electronic circuit. Improper operation may occur if you cut any of them.

# Part 4

## Functions and Control

1. Common Functions .....	38
1.1 Temperature Control .....	38
1.2 Frequency Principle.....	38
2. Functions for FTXR Series .....	40
2.1 Airflow Direction Control.....	40
2.2 Fan Speed Control for Indoor Unit .....	41
2.3 Program Dry Operation .....	42
2.4 Automatic Cooling/Heating Changeover .....	43
2.5 Thermostat Control.....	44
2.6 NIGHT SET Mode .....	45
2.7 ECONO Operation .....	45
2.8 2-Area INTELLIGENT EYE Operation .....	46
2.9 POWERFUL Operation .....	48
2.10 Multi-Monitor Lamp/TIMER Lamp .....	49
2.11 Clock Setting .....	50
2.12 WEEKLY TIMER Operation .....	51
2.13 Other Functions.....	57
3. Functions for FDMQ/FFQ Series .....	58
3.1 Airflow Direction Control.....	58
3.2 Fan Speed Control for Indoor Unit .....	59
3.3 Program Dry Operation .....	60
3.4 Clock and Calendar Setting (With BRC1E73).....	61
3.5 Schedule Timer Operation (With BRC1E73).....	63
3.6 Setback Function (With BRC1E73).....	67
3.7 Drain Pump Control.....	68
3.8 Hot Start Control (In Heating Operation Only).....	70
3.9 Presence and Floor Sensors (Option).....	71
3.10 Other Functions.....	74
4. Thermistor Functions .....	76
5. Control Specification .....	77
5.1 Mode Hierarchy .....	77
5.2 Frequency Control.....	77
5.3 Controls at Mode Changing/Start-up.....	79
5.4 Discharge Pipe Temperature Control.....	82
5.5 Input Current Control.....	83
5.6 High Pressure Protection Control.....	84
5.7 Freeze-up Protection Control .....	85
5.8 Heating Peak-cut Control .....	86
5.9 Outdoor Fan Control.....	87

5.10 Liquid Compression Protection Function.....	87
5.11 Defrost Control .....	88
5.12 Electronic Expansion Valve Control .....	89
5.13 Malfunctions .....	92

# 1. Common Functions

## 1.1 Temperature Control

### Definitions of Temperatures

The definitions of temperatures are classified as following.

- Room temperature: temperature of lower part of the room
- Set temperature: temperature set by remote controller
- Room thermistor temperature: temperature detected by room temperature thermistor
- Target temperature: temperature determined by microcomputer

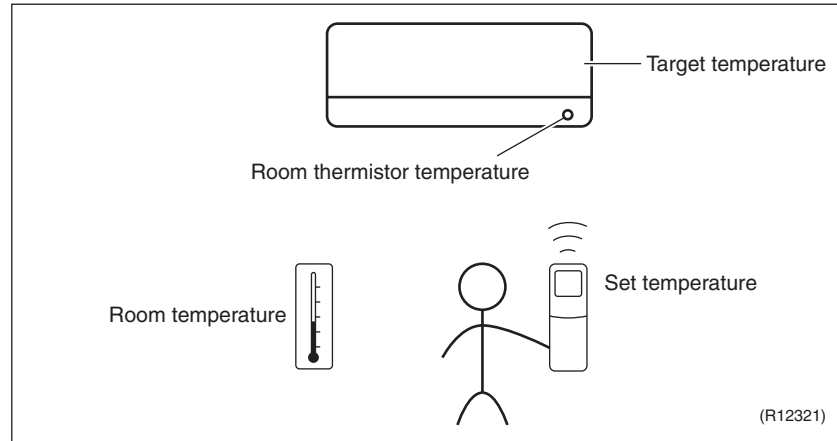

★ The illustration is for wall mounted type as representative.

### Temperature Control

The temperature of the room is detected by the room temperature thermistor. However, there is a difference between the temperature detected by room temperature thermistor and the temperature of lower part of the room, depending on the type of the indoor unit or installation condition. In practice, the temperature control is done by the target temperature appropriately adjusted for the indoor unit and the temperature detected by room temperature thermistor.

## 1.2 Frequency Principle

### Control Parameters

The frequency of the compressor is controlled by the following 2 parameters:

- The load condition of the operating indoor unit
- The difference between the room thermistor temperature and the target temperature

The target frequency is adapted by additional parameters in the following cases:

- Frequency restrictions
- Initial settings
- Forced cooling operation

### Inverter Principle

To regulate the capacity, a frequency control is needed. The inverter makes it possible to control the rotation speed of the compressor. The followings explain the inverter principle:

#### Phase 1

The supplied AC power source is converted into the DC power source for the present.

#### Phase 2

The DC power source is reconverted into the three phase AC power source with variable frequency.



- When the frequency increases, the rotation speed of the compressor increases resulting in an increase of refrigerant circulation. This leads to a larger amount of heat exchange per unit.
- When the frequency decreases, the rotation speed of the compressor decreases resulting in a decrease of refrigerant circulation. This leads to a smaller amount of heat exchange per unit.

The following drawing shows a schematic view of the inverter principle:

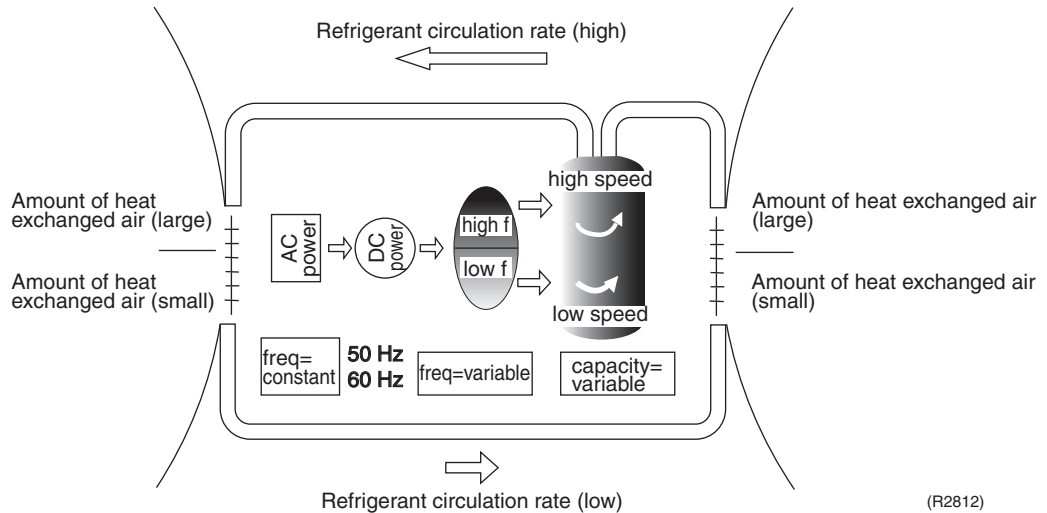

## Inverter Features

The inverter provides the following features:

- The regulating capacity can be changed according to the changes in the outdoor temperature and cooling/heating load.
- Quick heating and quick cooling  
The rotation speed of the compressor is increased when starting the heating (cooling). This enables to reach the set temperature quickly.
- Even during extreme cold weather, high capacity is achieved. It is maintained even when the outdoor temperature is 2°C (35.6°F).
- Comfortable air conditioning  
A fine adjustment is integrated to keep the room temperature constant.
- Energy saving heating and cooling  
Once the set temperature is reached, the energy saving operation enables to maintain the room temperature at low power.

## Frequency Limits

The following functions regulate maximum frequency:

### Low frequency

- Four way valve operation compensation. Refer to page 80.

### High frequency

- Compressor protection function. Refer to page 81.
- Discharge pipe temperature control. Refer to page 82.
- Input current control. Refer to page 83.
- Freeze-up protection control. Refer to page 85.
- Heating peak-cut control. Refer to page 86.
- Defrost control. Refer to page 88.

## Forced Cooling Operation

Refer to page 204 for details.

## 2. Functions for FTXR Series

### 2.1 Airflow Direction Control

**Power-Airflow Dual Flaps**

The large flap sends a large volume of air downward to the floor and provides an optimum control in cooling, dry and heating operation.

**Cooling/Dry**

During cooling or dry operation, the flap retracts into the indoor unit. Then, cool air can be blown far and distributed all over the room.

**Heating**

During heating operation, the large flap directs airflow downward to spread the warm air to the entire room.

**Wide-Angle Louvers**

The louvers, made of elastic synthetic resin, provide a wide range of airflow that guarantees comfortable air distribution.

**Auto-Swing**

The following tables explain the auto-swing process for cooling, dry, heating and fan:

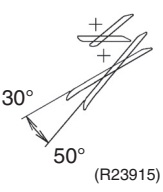
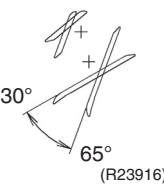
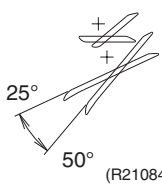
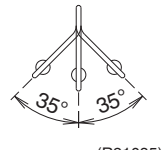
	Flap (up and down)			Louver (right and left)
	Cooling/Dry	Heating	Fan	
09/12/18 class				

**3-D Airflow**

Alternative repetition of vertical and horizontal swing motions enables uniform air-conditioning of the entire room.

When the horizontal swing and vertical swing are both set to automatic operation, the airflow becomes 3-D airflow. The horizontal and vertical swing motions are alternated and the airflow direction changes in the order shown in the following diagram.

- (1) The vertical blades (louvers) move from the right to the left.
- (2) The horizontal blades (flaps) move downward.
- (3) The vertical blades (louvers) move from the left to the right.
- (4) The horizontal blades (flaps) move upward.

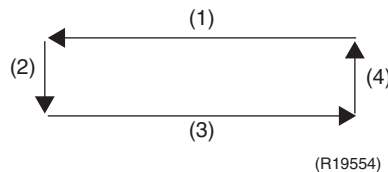

**COMFORT AIRFLOW Operation**

The flaps are controlled not to blow the air directly at the people in the room.

The airflow direction is upward while in cooling operation, and downward while in heating operation. This function prevents cold or warm air from blowing directly on the occupants in the room.

## 2.2 Fan Speed Control for Indoor Unit

### Outline

Phase control and fan speed control contains 9 steps: LLL, LL, SL, L, ML, M, MH, H, and HH. The airflow rate can be automatically controlled depending on the difference between the room thermistor temperature and the target temperature.

### Automatic Fan Speed Control

In automatic fan speed operation, the step SL is not available.

Step	Cooling	Heating
LLL	↕	↕
LL		
L		
ML		
M		
MH		
H		
HH (POWERFUL)		

↕ = The airflow rate is automatically controlled within this range when **FAN** setting button is set to automatic. R4003512

#### ■ Cooling

The following drawing explains the principle of fan speed control for cooling.

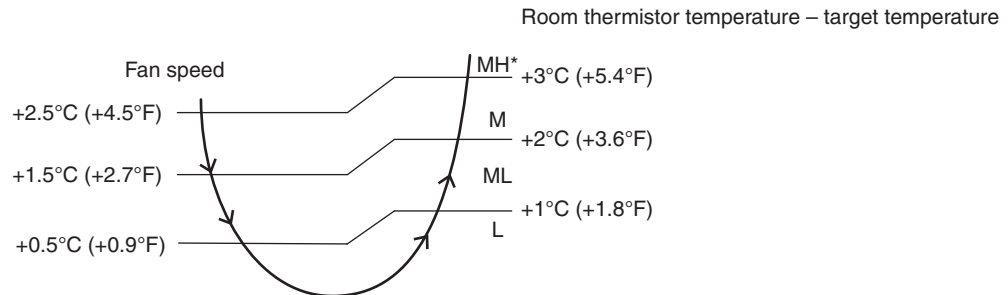

(R21654)

\* The upper limit is at M tap in 30 minutes from the operation start.

#### ■ Heating

In heating operation, the fan speed is regulated according to the indoor heat exchanger temperature and the difference between the room thermistor temperature and the target temperature.



#### Note(s)

The fan stops during defrost operation.

### COMFORT AIRFLOW Operation

- The fan speed is controlled automatically within the following steps.

#### Cooling

L tap ~ MH tap (same as AUTOMATIC)

#### Heating

In order to obtain a comfortable airflow, the fan speed may be set to a rate different from automatic fan speed control.

- POWERFUL operation and COMFORT AIRFLOW operation cannot be used at the same time.

## 2.3 Program Dry Operation

**Outline**

Program dry operation removes humidity while preventing the room temperature from lowering. Since the microcomputer controls both the temperature and airflow rate, the temperature adjustment and **FAN** setting buttons are inoperable.

**Details**

The microcomputer automatically sets the temperature and airflow rate. The difference between the room thermistor temperature at start-up and the target temperature is divided into two zones. Then, the unit operates in an appropriate capacity for each zone to maintain the temperature and humidity at a comfortable level.

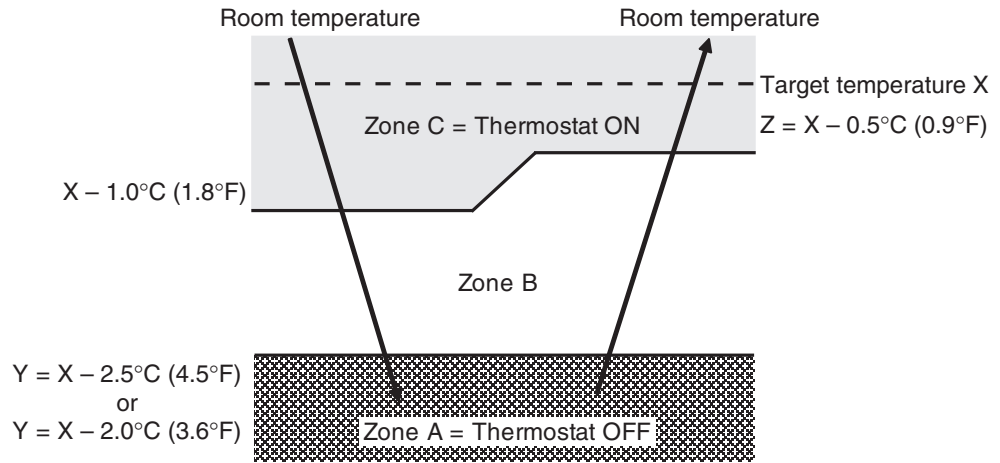

(R24029)

Room thermistor temperature at start-up	Target temperature X	Thermostat OFF point Y	Thermostat ON point Z ★
24°C or more (75.2°F or more)	Room thermistor temperature at start-up	X - 2.5°C (X - 4.5°F)	X - 0.5°C (X - 0.9°F)
18 ~ 23.5°C (64.4 ~ 74.3°F)		X - 2.0°C (X - 3.6°F)	X - 0.5°C (X - 0.9°F)
17.5°C or less (63.5°F or less)	18°C (64.4°F)	X - 2.0°C (X - 3.6°F)	X - 0.5°C = 17.5°C (X - 0.9°F = 63.5°F)

★ Thermostat turns on also when the room temperature is in the zone B for 10 minutes.

## 2.4 Automatic Cooling/Heating Changeover

### Outline

When the automatic operation is selected with the remote controller, the microcomputer automatically determines the operation mode as cooling or heating according to the room temperature and the set temperature at start-up.

The unit automatically switches the operation mode to maintain the room temperature at the set temperature.

### Details

Ts: set temperature (set by remote controller)

Tt: target temperature (determined by microcomputer)

Tr: room thermistor temperature (detected by room temperature thermistor)

C: correction value

- The set temperature (Ts) determines the target temperature (Tt).  
(Ts = 18 ~ 30°C (64.4 ~ 86°F))
- The target temperature (Tt) is calculated as;  
Tt = Ts + C  
where C is the correction value.  
C = 0°C (0°F)
- Thermostat ON/OFF point and operation mode switching point are as follows.
  - Heating → Cooling switching point:  
 $Tr \geq Tt + 3.0^{\circ}\text{C}$  (+ 5.4°F)
  - Cooling → Heating switching point:  
 $Tr < Tt - 2.5^{\circ}\text{C}$  (- 4.5°F)
  - Thermostat ON/OFF point is the same as the ON/OFF point of cooling or heating operation.
- During initial operation  
Tr ≥ Ts : Cooling operation  
Tr < Ts : Heating operation

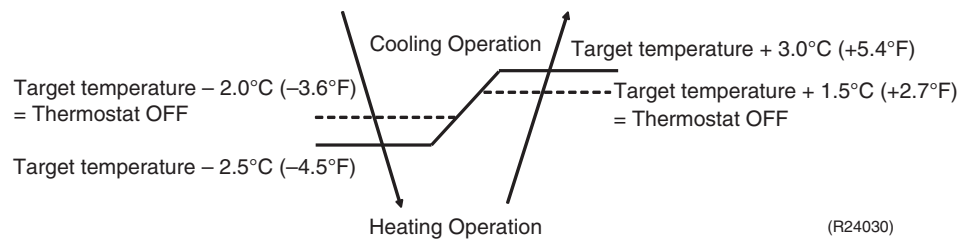

Ex: When the target temperature is 25°C (77°F)

Cooling → 23°C (73.4°F): Thermostat OFF → 22.5°C (72.5°F): Switch to heating

Heating → 26.5°C (79.7°F): Thermostat OFF → 28°C (82.4°F): Switch to cooling

## 2.5 Thermostat Control

**Outline** Thermostat control is based on the difference between the room thermistor temperature and the target temperature.

- Details**
- Thermostat OFF Conditions**
- The temperature difference is in the zone A.
- Thermostat ON Conditions**
- The temperature difference returns to the zone C after being in the zone A.
  - The system resumes from defrost control in any zones except A.
  - The operation turns on in any zones except A.
  - The monitoring time has passed while the temperature difference is in the zone B.  
(Cooling: 10 minutes, Heating: 10 seconds)

**Cooling**

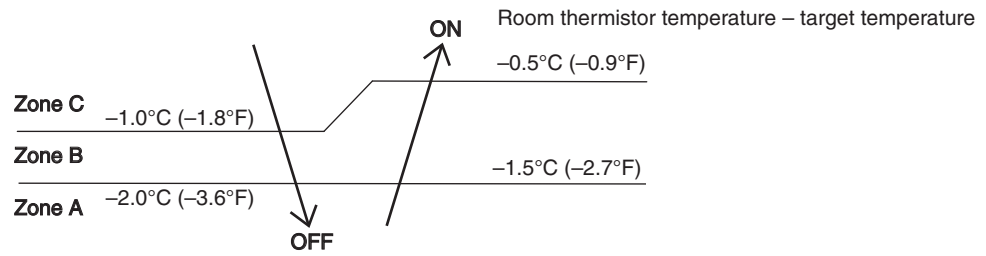

**Heating**

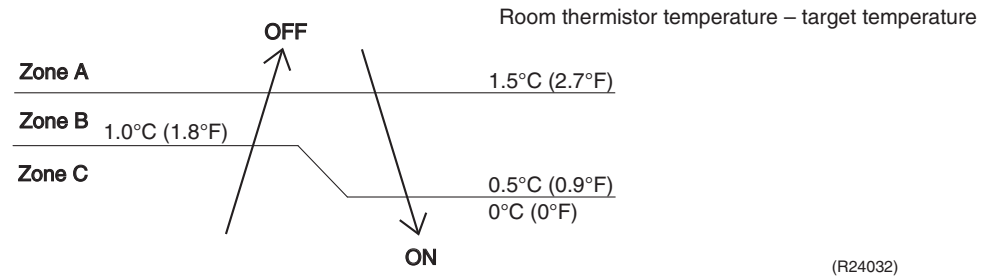

**Reference** Refer to Temperature Control on page 38 for details.

## 2.6 NIGHT SET Mode

### Outline

When the OFF TIMER is set, NIGHT SET mode is automatically activated. NIGHT SET mode keeps the airflow rate setting.

### Details

NIGHT SET mode continues operation at the target temperature for the first one hour, then automatically raises the target temperature slightly in the case of cooling, or lowers the target temperature slightly in the case of heating. This prevents excessive cooling in summer and excessive heating in winter to ensure comfortable sleeping conditions, and also conserves electricity.

#### Cooling

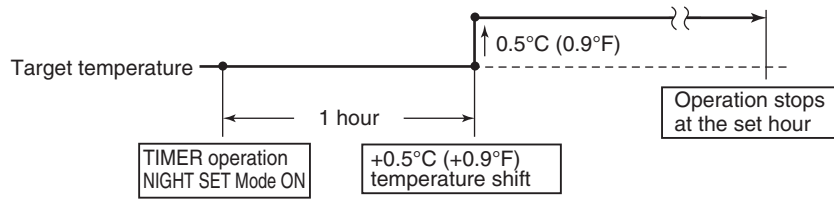

(R23917)

#### Heating

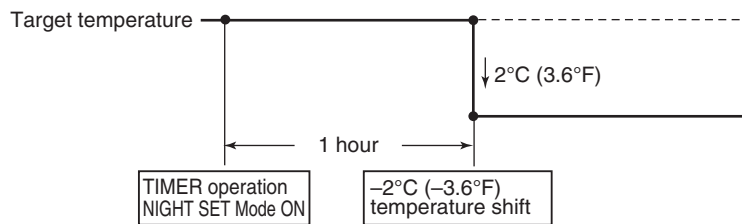

(R23918)

## 2.7 ECONO Operation

### Outline

ECONO operation reduces the maximum operating current and the power consumption. This operation is particularly convenient for energy-saving. It is also a major bonus when breaker capacity does not allow the use of multiple electrical devices and air conditioners. It can be easily activated by pressing **Econo/Quiet** button on the wireless remote controller.

### Details

- When this function is activated, the maximum capacity also decreases.
- The remote controller can send the ECONO command when the unit is in cooling, heating, dry, or automatic operation. This function can only be set when the unit is running. To cancel the ECONO operation, press **Econo/Quiet** button several times until the ECONO symbol disappears.
- This function and POWERFUL operation cannot be used at the same time. The latest command has the priority.

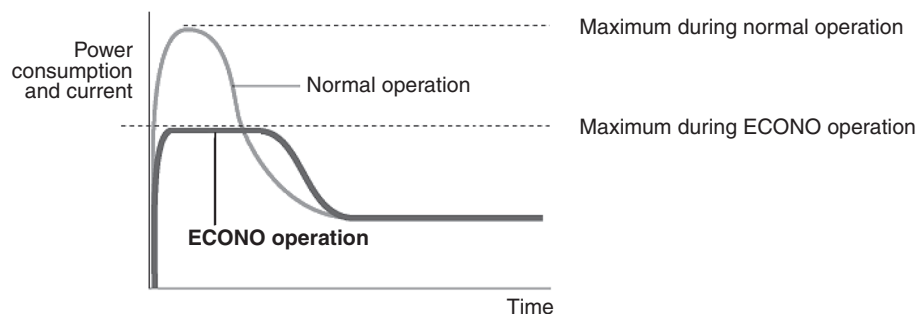

(R22012)

## 2.8 2-Area INTELLIGENT EYE Operation

### Outline

The following functions can be performed by the microcomputer and a motion sensor.

1. Reduction of the capacity when there is nobody in the room in order to save electricity (energy saving operation)
2. Dividing the room into plural areas and detecting presence in each area. Moving the airflow direction to the area with no presence automatically to avoid direct airflow on humans.

### Details

#### 1. INTELLIGENT EYE detection method

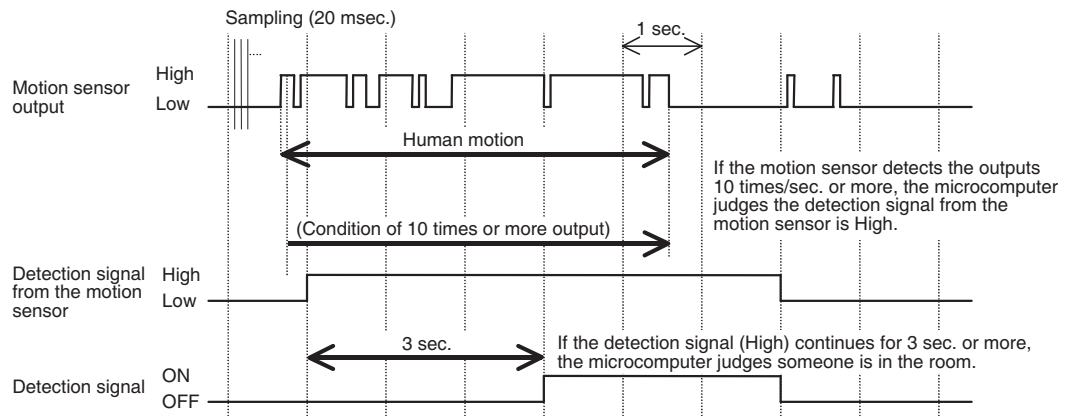

R4003448

- The motion sensor detects human motion by receiving infrared rays and sends the pulse wave output.
- The microcomputer in the indoor unit carries out a sampling every 20 msec. If the motion sensor detects 10 times or more of the wave output in one second in total, and the High signal continues for 3 sec., the microcomputer judges someone is in the room as the detection signal is ON.
- 2-area INTELLIGENT EYE motion sensor divides the area into 2 and detects presence in each area.

#### Image of 2-area INTELLIGENT EYE

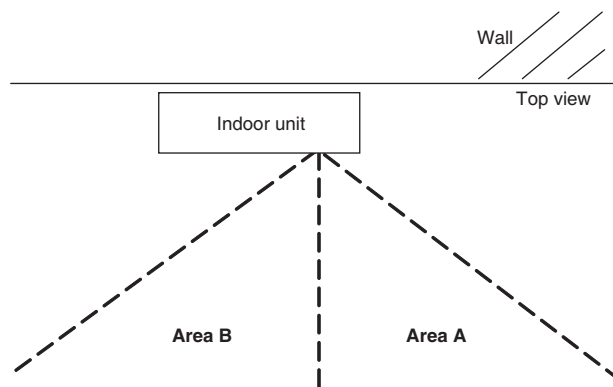

A microcomputer judges someone by the detection signal from each area A and B.

R4003428



## 2. Motions (in cooling)

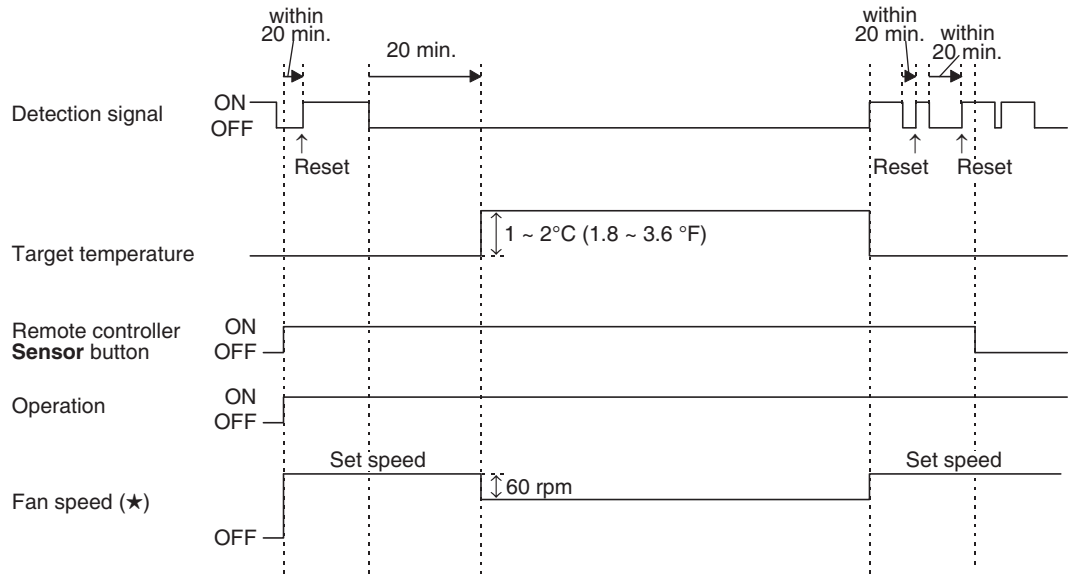

R4003436

★ In FAN operation, the fan speed is reduced by 60 rpm when no one is in the area.

- When there is no signal from the motion sensor in 20 minutes, the microcomputer judges that nobody is in the room and operates the unit at a temperature shifted from the target temperature. (Cooling/Dry: 1 ~ 2°C (1.8 ~ 3.6°F) higher, Heating: 2°C (3.6°F) lower, Auto: according to the operation mode at that time)

## 3. Airflow direction in 2-area INTELLIGENT EYE operation

- Detection method: The opposite area of detected area is set as the target direction.

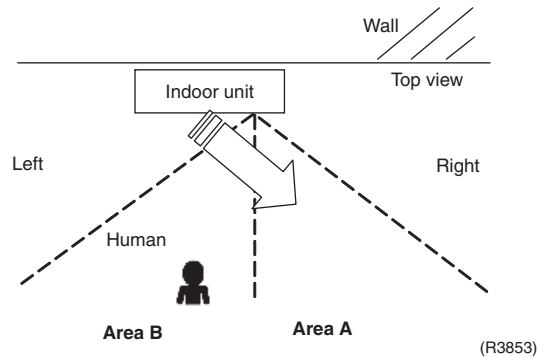

1. Detection signal ON in both areas A and B: Shift the airflow direction to area B (left side)
2. Detection signal ON in area A: Shift the airflow direction to area B (left side)
3. Detection signal ON in area B: Shift the airflow direction to area A (right side)
4. Detection signal OFF in both areas A and B: No change

\* When the detection signal is OFF for 20 minutes in both areas A and B, the unit starts energy saving operation.



### Note(s)

For dry operation, the temperature cannot be set with a remote controller, but the target temperature is shifted internally.

## 2.9 POWERFUL Operation

**Outline**

In order to exploit the cooling and heating capacity to full extent, the air conditioner can be operated by increasing the indoor fan rotating speed and the compressor frequency.

**Details**

When **POWERFUL** button is pressed, the fan speed and target temperature are converted to the following states for 20 minutes.

Operation mode	Fan speed	Target temperature
COOL	H tap + <b>A</b> rpm	18°C (64.4°F)
DRY	Dry rotating speed + <b>A</b> rpm	Lowered by 2.5°C (4.5°F)
HEAT	H tap + <b>A</b> rpm	31°C (87.8°F)
FAN	H tap + <b>A</b> rpm	—
AUTO	Same as cooling/heating in POWERFUL operation	The target temperature is kept unchanged.

**A** = ~ 80 rpm

Ex: POWERFUL operation in cooling

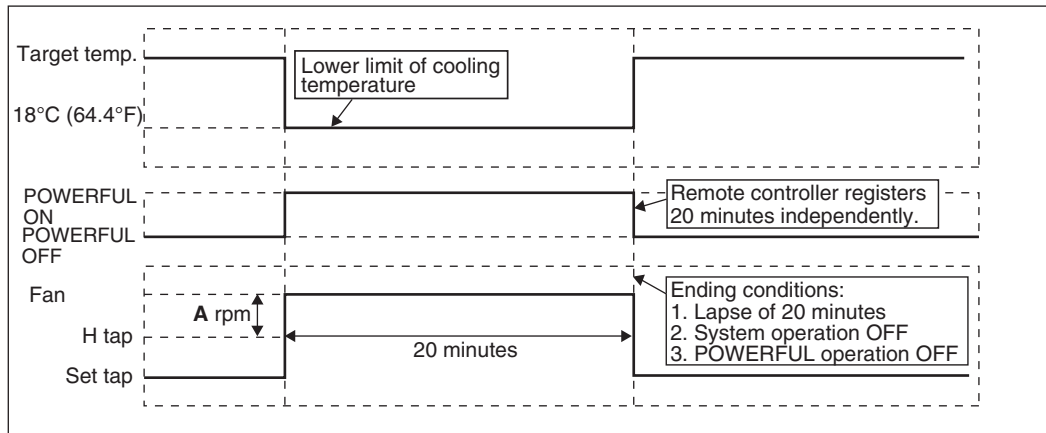

(R24589)

**i** Notes

POWERFUL operation cannot be used together with ECONO, COMFORT AIRFLOW or QUIET OUTDOOR UNIT operation.

## 2.10 Multi-Monitor Lamp/TIMER Lamp

### Features

Current operation mode is displayed in color of the lamp of the indoor unit. Operating status can be monitored even in automatic operation in accordance with the actual operation mode.

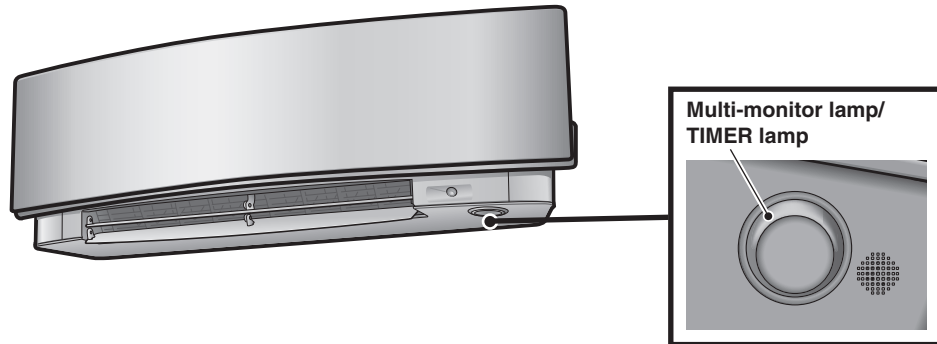

(R19925)

The lamp color changes according to the operation.

- \* AUTO.....Red/Blue
- \* DRY.....Green
- \* COOL.....Blue
- \* HEAT.....Red
- \* FAN.....White
- \* TIMER.....Orange

### Brightness Setting

Each time **Brightness** button on the remote controller is pressed, the brightness of the multi-monitor lamp changes to high, low, or off.

## 2.11 Clock Setting

### ARC466 Series

The clock can be set by taking the following steps:

1. Press **Clock** button.  
→ **0:00** is displayed, then **MON** and ☺ blink.
2. Press **Select ▲** or **Select ▼** button to set the clock to the current day of the week.
3. Press **Clock** button.  
→ ☺ blinks.
4. Press **Select ▲** or **Select ▼** button to set the clock to the present time.  
Holding down **Select ▲** or **Select ▼** button rapidly increases or decreases the time display.
5. Press **Clock** button to set the clock. Point the remote controller at the indoor unit when pressing the button.  
→ : blinks and clock setting is completed.

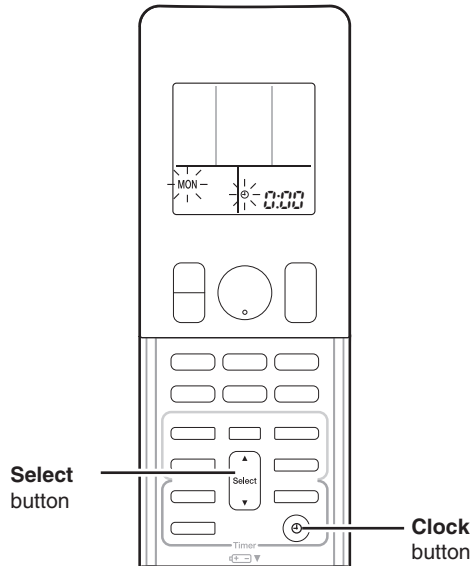

(R19926)

## 2.12 WEEKLY TIMER Operation

### Outline

Up to 4 timer settings can be saved for each day of the week (up to 28 settings in total). The 3 items: ON/OFF, temperature, and time can be set.

### Details

#### Setting example of the WEEKLY TIMER

The same timer settings are used from Monday through Friday, while different timer settings are used for the weekend.

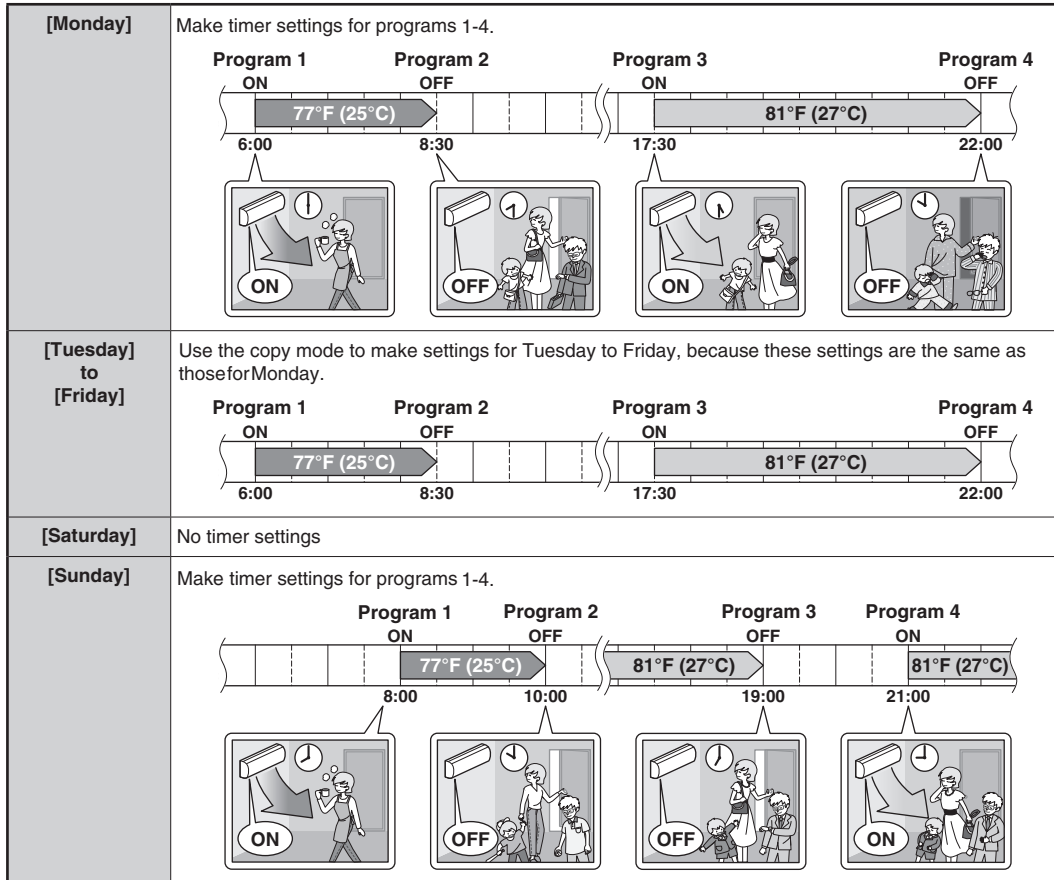

- Up to 4 reservations per day and 28 reservations per week can be set using the WEEKLY TIMER. The effective use of the copy mode simplifies timer programming.
- The use of ON-ON-ON-ON settings, for example, makes it possible to schedule operating mode and set temperature changes. Furthermore, by using OFF-OFF-OFF-OFF settings, only the turn off time of each day can be set. This will turn off the air conditioner automatically if you forget to turn it off.

R4003381

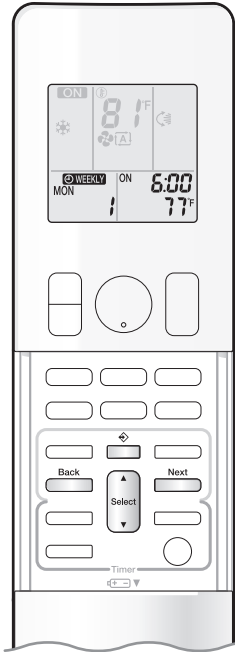

**To use WEEKLY TIMER operation**

**Setting mode**

- Make sure the day of the week and time are set. If not, set the day of the week and time.

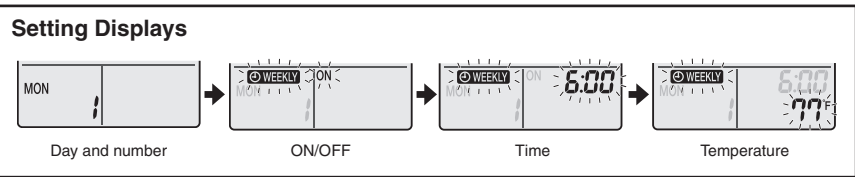
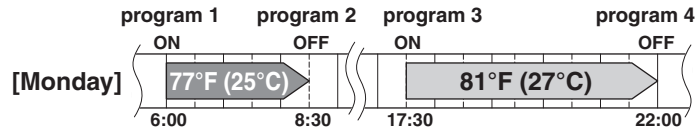

**1. Press [Up Arrow].**

- The day of the week and the reservation number of the current day will be displayed.
- 1 to 4 settings can be made per day.

**2. Press [Select] to select the desired day of the week and reservation number.**

- Pressing [Select] changes the reservation number and the day of the week.

**3. Press [Next].**

- The day of the week and reservation number will be set.
- “WEEKLY” and “ON” blink.

**4. Press [Select] to select the desired mode.**

- Pressing [Select] changes the “ON” or “OFF” setting in sequence.



- In case the reservation has already been set, selecting “blank” deletes the reservation.
- Proceed to **STEP 9** if “blank” is selected.
- To return to the day of the week and reservation number setting, press [Back].

**5. Press [Next].**

- The ON/OFF TIMER mode will be set.
- “WEEKLY” and the time blink.

R4003382

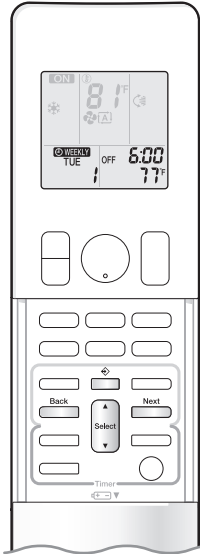

**6. Press  to select the desired time.**

- The time can be set between 0:00 and 23:50 in 10-minute intervals.
- To return to the ON/OFF TIMER mode setting, press .
- Proceed to **STEP 9** when setting the OFF TIMER.

**7. Press .**

- The time will be set.
- “ WEEKLY ” and the temperature blink.

**8. Press  to select the desired temperature.**

- The temperature can be set between 50°F (10°C) and 90°F (32°C).  
COOL or AUTO: The unit operates at 64°F (18°C) even if it is set at 50°F (10°C) to 63°F (17°C).  
HEAT or AUTO : The unit operates at 86°F (30°C) even if it is set at 87°F (31°C) to 90°F (32°C).
- To return to the time setting, press .
- The set temperature is only displayed when the mode setting is on.

**9. Press .**

- Be sure to direct the remote controller toward the indoor unit and check for a receiving tone and blinking of the multi-monitor lamp.
- The multi-monitor lamp blinks twice.
- The temperature will be set and go to the next reservation.
- Temperature and time are set in the case of ON TIMER operation, and the time is set in the case of OFF TIMER operation.
- The next reservation screen will appear.
- To continue further settings, repeat the procedure from **STEP 4**.

**10. Press  to complete the setting.**

- “ WEEKLY ” is displayed on the LCD and WEEKLY TIMER operation is activated.
- The TIMER lamp periodically lights orange.  
The multi-monitor lamp will not light orange if all the reservation settings are deleted.





Display

- A reservation made once can be easily copied and the same settings used for another day of the week. Refer to **Copy mode**.

**NOTE**

**Notes on WEEKLY TIMER operation**

- Do not forget to set the clock on the remote controller first.
- The day of the week, ON/OFF TIMER mode, time and set temperature (only for ON TIMER mode) can be set with the WEEKLY TIMER. Other settings for the ON TIMER are based on the settings just before the operation.
- WEEKLY TIMER and ON/OFF TIMER operation cannot be used at the same time. The ON/OFF TIMER operation has priority if it is set while WEEKLY TIMER is still active. The WEEKLY TIMER will enter the standby state, and “ WEEKLY ” will disappear from the LCD. When the ON/OFF TIMER is up, the WEEKLY TIMER will automatically become active.
- Only the time and temperature can be set with the WEEKLY TIMER. Set the WEEKLY TIMER only after setting the operation mode, the airflow rate and the airflow direction ahead of time.
- Turning off the circuit breaker, power failure, and other similar events will render operation of the indoor unit's internal clock inaccurate. Reset the clock.
-  can be used only for the time and temperature settings. It cannot be used to go back to the reservation number.

R4003383

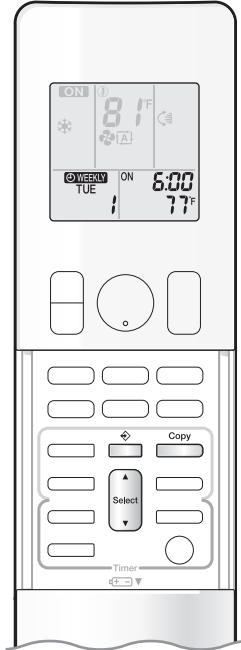

**Copy mode**

- A reservation made once can be copied to another day of the week. The whole reservation of the selected day of the week will be copied.

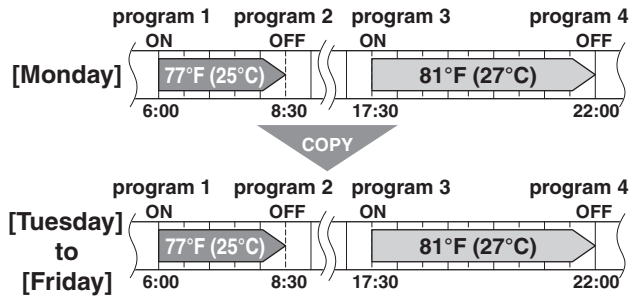

**Setting Displays**

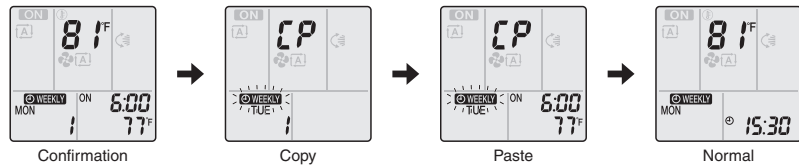

1. Press .
2. Press to confirm the day of the week to be copied.
3. Press .
  - The whole reservation of the selected day of the week will be copied.
4. Press to select the destination day of the week.
5. Press .
  - Be sure to direct the remote controller toward the indoor unit and check for a receiving tone and blinking of the multi-monitor lamp.
  - The multi-monitor lamp blinks twice.
  - The reservation will be copied to the selected day of the week. The whole reservation of the selected day of the week will be copied.
  - To continue copying the settings to other days of the week, repeat **STEP 4** and **STEP 5**.
6. Press to complete the setting.
  - “ WEEKLY” is displayed on the LCD and WEEKLY TIMER operation is activated.
  - The TIMER lamp periodically lights orange.

**NOTE**

**Note on COPY MODE**

- The entire reservation of the source day of the week is copied in the copy mode.
- In the case of making a reservation change for any day of the week individually after copying the content of weekly reservations, press and change the settings in the steps of **Setting mode** .



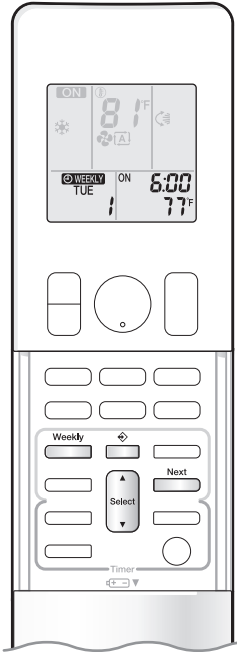

**Confirming a reservation**

- The reservation can be confirmed.

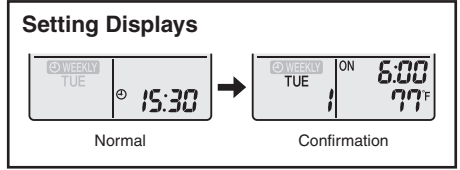

**1. Press [Weekly].**

- The day of the week and the reservation number of the current day will be displayed.

**2. Press [Select] to select the day of the week and the reservation number to be confirmed.**

- Pressing [Select] displays the reservation details.
- To change the confirmed reserved settings, select the reservation number and press [Next]. The mode is switched to setting mode. Proceed to **Setting mode STEP 4.**

**3. Press [Weekly] to exit the confirmation mode.**

- “ [WEEKLY] ” is displayed on the LCD and WEEKLY TIMER operation is activated.
- The TIMER lamp periodically lights orange. The multi-monitor lamp will not light orange if all the reservation settings are deleted.



Display

**To deactivate WEEKLY TIMER operation**

**Press [Weekly] while “ [WEEKLY] ” is displayed on the LCD.**

- “ [WEEKLY] ” disappears from the LCD.
- The TIMER lamp goes off.
- To reactivate the WEEKLY TIMER operation, press [Weekly] again.
- If a reservation deactivated with [Weekly] is activated once again, the last reservation mode will be used.

**NOTE**

- If not all the reservation settings are reflected, deactivate the WEEKLY TIMER operation once. Then press [Weekly] again to reactivate the WEEKLY TIMER operation.

R4003385

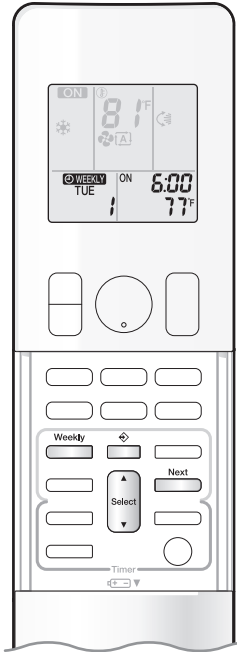

**To delete reservations**

**An individual reservation**

- 1. Press** .  
 • The day of the week and the reservation number will be displayed.
- 2. Press** **to select the day of the week and the reservation number to be deleted.**
- 3. Press** .  
 • “ WEEKLY” and “ON” or “OFF” blink.
- 4. Press** **until no icon is displayed.**  
 • Pressing changes the ON/OFF TIMER mode in sequence.  
 • Selecting “blank” will cancel any reservation you may have.



- 5. Press** .  
 • The selected reservation will be deleted.  
 • Be sure to direct the remote controller toward the indoor unit and check for a receiving tone and blinking of the multi-monitor lamp.
- 6. Press** .  
 • If there are still other reservations, WEEKLY TIMER operation will be activated.

**Reservations for each day of the week**

- This function can be used for deleting reservations for each day of the week.
  - It can be used while confirming or setting reservations.
- 1. Press** .  
 • The day of the week and the reservation number will be displayed.
  - 2. Press** **to select the day of the week to be deleted.**
  - 3. Hold** **for about 5 seconds.**  
 • Be sure to direct the remote controller toward the indoor unit and check for a receiving tone and blinking of the multi-monitor lamp.  
 • The reservation of the selected day of the week will be deleted.
  - 4. Press** .  
 • If there are still other reservations, WEEKLY TIMER operation will be activated.

**All reservations**

- **Hold** **for about 5 seconds with the normal display.**  
 • Be sure to direct the remote controller toward the indoor unit and check for a receiving tone and blinking of the multi-monitor lamp.  
 • The TIMER lamp goes off.  
 • This operation cannot be used for the WEEKLY TIMER setting display.  
 • All reservations will be deleted.

## 2.13 Other Functions

### 2.13.1 Hot-Start Function

In order to prevent the cold air blast that normally occurs when heating operation is started, the temperature of the indoor heat exchanger is detected, and the airflow is either stopped or significantly weakened resulting in comfortable heating.



**Note(s)** The cold air blast is prevented using similar control when defrost control starts or when the thermostat is turned ON.

### 2.13.2 Signal Receiving Sign

When the indoor unit receives a signal from the remote controller, the unit emits a signal receiving sound.

### 2.13.3 Indoor Unit ON/OFF Switch

**ON/OFF** switch is provided on the display of the unit.

- Press **ON/OFF** switch once to start operation. Press once again to stop it.
- **ON/OFF** switch is useful when the remote controller is missing or the battery has run out.
- The operation mode refers to the following table.

Operation mode	Temperature setting	Airflow rate
AUTO	25°C (77°F)	Automatic

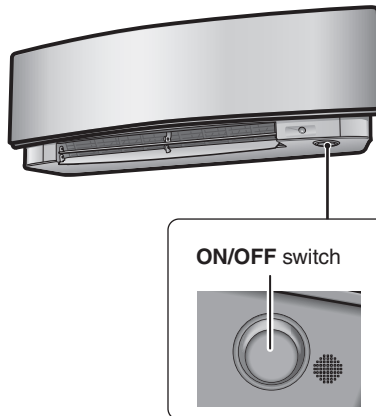

(R23923)

#### Forced cooling operation

Forced cooling operation can be started by pressing **ON/OFF** switch for 5 ~ 9 seconds while the unit is not operating.

Refer to page 204 for details.



**Note(s)** Forced cooling operation is not started if **ON/OFF** switch is pressed for 10 seconds or more.

### 2.13.4 Auto-restart Function

If a power failure (even a momentary one) occurs during the operation, the system restarts automatically in the same conditions as before when the power supply is restored to the conditions prior to the power failure.



**Note** It takes 3 minutes to restart the operation because 3-minute standby function is activated.

# 3. Functions for FDMQ/FFQ Series

## 3.1 Airflow Direction Control

**Applicable Models** FFQ09/12/15/18W2VJU9

**Outline** There are two types of airflow direction settings.

- Automatic swing setting  
The flaps automatically oscillate up and down.

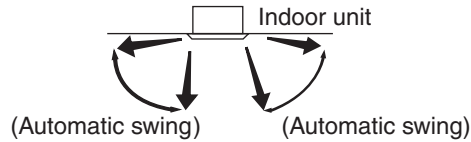

(R24069)

- Airflow direction fixed setting  
You can select from one of the fixed directions.  
The display of the remote controller and the actual angle of the flap do not match.

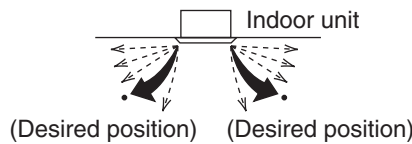

(R24070)

**Flaps Movement** Under the operating conditions shown below, airflow direction is controlled automatically. Actual operation may be different from what is displayed on the remote controller.

- Room temperature is higher than the remote controller's set temperature in heating operation.
- When defrosting in heating operation. The airflow is discharged horizontally to avoid blowing cold air directly on the room occupants.
- Under continuous operation with the airflow discharging horizontally.

**Individual Flap Control** With decoration panel (BYFQ60C2W1W(S)) and wired remote controller (BRC1E73), you can control each one of the four flaps individually. The following marks are beside each air outlet: □, □□, □□□, □□□□.

## 3.2 Fan Speed Control for Indoor Unit

### ■ With Wired Remote Controller (BRC1E73)

To change the fan speed, press **Fan Speed** button and select the fan speed from Low/Medium/High/Auto.

- ◆ Auto cannot be selected if the indoor unit does not have Auto Fan speed function.
- ◆ The system may change the fan speed automatically for equipment protection purposes.
- ◆ The system may turn off the fan when the room temperature is satisfied.
- ◆ It is normal for a delay to occur when changing the fan speed.
- ◆ If the Auto is selected for the fan speed, the fan speed varies automatically based on the difference between set temperature and room temperature.

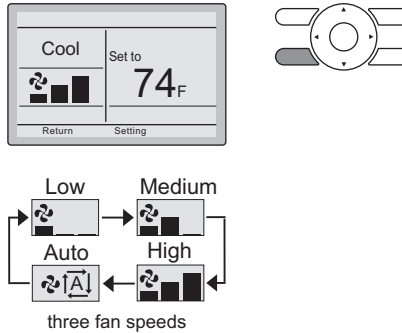

R4003380

### ■ With Wireless Remote Controller (BRC082A43, BRC082A41W, BRC082A42W(S))

Press **FAN SPEED CONTROL** button.

High, Medium or Low fan speed can be selected.

The microchip may sometimes control the fan speed in order to protect the unit.

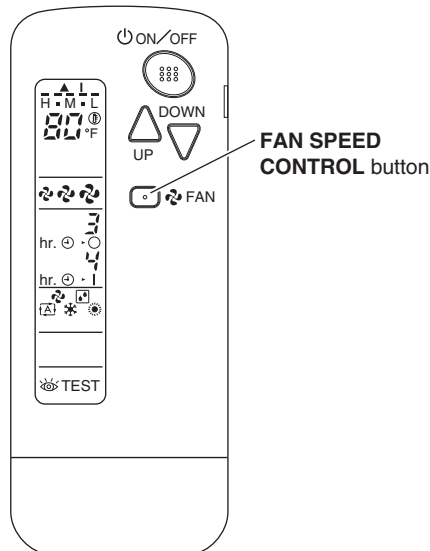

R4003666

### 3.3 Program Dry Operation

**Outline** Program dry operation removes humidity while preventing the room temperature from lowering. Since the microcomputer controls both the temperature and airflow rate, the temperature adjustment and **FAN** setting buttons are inoperable.

**Details** The microcomputer automatically sets the temperature and airflow rate. The difference between the room thermistor temperature at start-up and the target temperature is divided into two zones. Then, the unit operates in an appropriate capacity for each zone to maintain the temperature and humidity at a comfortable level.

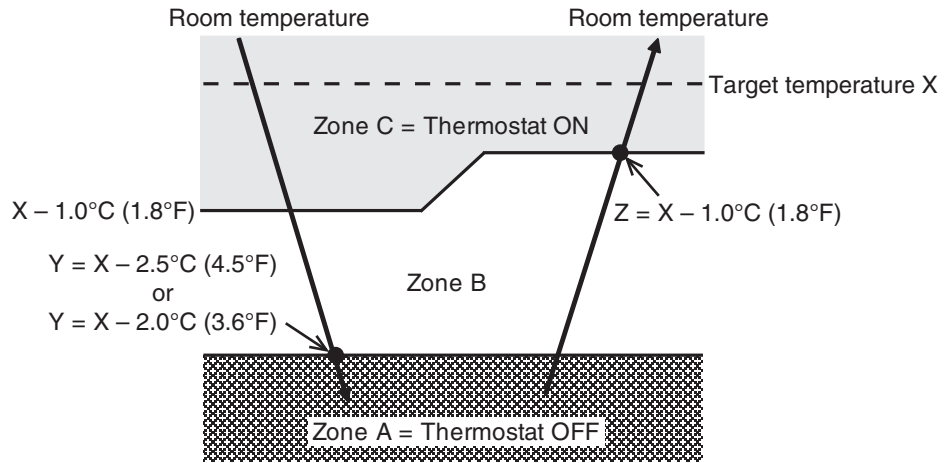

(R23000)

Room thermistor temperature at start-up	Target temperature X	Thermostat OFF point Y	Thermostat ON point Z
24.5°C or more (76.1°F or more)	Room thermistor temperature at start-up	X - 2.5°C (X - 4.5°F)	X - 1.0°C (X - 1.8°F)
16.5 ~ 24°C (61.7 ~ 75.2°F)		X - 2.0°C (X - 3.6°F)	X - 1.0°C (X - 1.8°F)
16°C or less (60.8°F or less)	16°C (60.8°F)	X - 2.0°C (X - 3.6°F)	X - 1.0°C = 15°C (X - 1.8°F = 59°F)

## 3.4 Clock and Calendar Setting (With BRC1E73)

- 1**

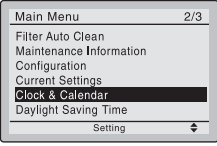

  - Press **Menu/OK** button to display the main menu screen.
  - Press **▼▲** buttons to select **Clock & Calendar** on the main menu screen.

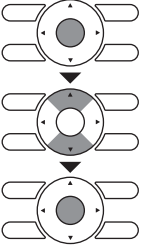
Press **Menu/OK** button to display the clock & calendar screen.

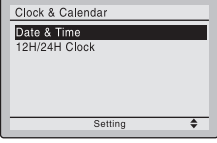

---

- 2**

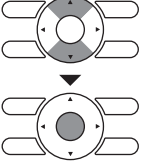

  - Press **▼▲** buttons to select **Date & Time** on the clock & calendar screen.

Press **Menu/OK** button to display the date & time screen.

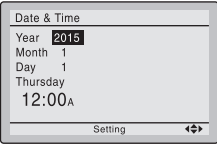

---

- 3**

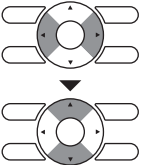

  - Select **Year** with **◀▶** buttons.

Change the year with **▼▲** buttons. Holding down the button causes the number to change continuously.

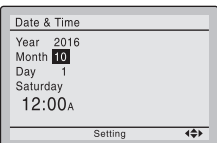

---

- 4**

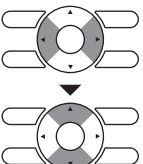

  - Select **Month** with **◀▶** buttons.

Change the month with **▼▲** buttons. Holding down the button causes the number to change continuously.

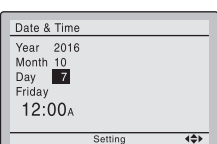

---

- 5**

  - Select **Day** with **◀▶** buttons.

Change the day with **▼▲** buttons. Holding down the button causes the number to change continuously. Days of the week change automatically.

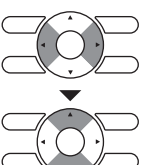

(R24368)

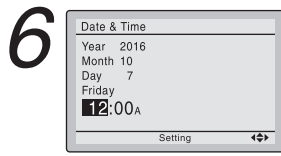

- Select **Hour** with ◀▶ buttons.
- Change the hour with ▼▲ buttons.
- Holding down the button causes the number to change continuously.

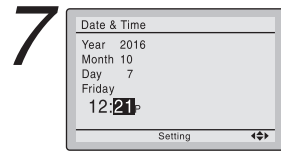
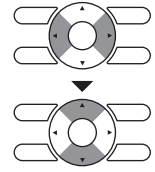

- Select **Minute** with ◀▶ buttons.
- Change the minute with ▼▲ buttons.
- Holding down the button causes the number to change continuously.
- Press **Menu/OK** button.
- The confirmation screen will appear.

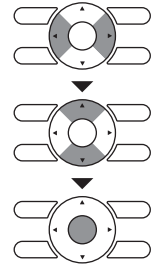

**Note:**  
The date can be set between January 1, 2015 and December 31, 2099.



- Press ◀▶ button to select **Yes** on the confirmation screen.
- Press **Menu/OK** button to confirm the clock and return to the basic screen.

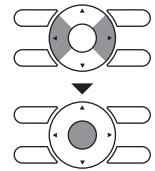

\* When setting the schedule, the display returns to the settings screen.

(R24072)



## 3.5 Schedule Timer Operation (With BRC1E73)

### Outline

Day settings are selected from 4 patterns:

- 7 Days
- Weekday/Sat/Sun
- Weekday/Weekend
- Everyday

Up to 5 actions can be set for each day.

### Details

Set the startup time and operation stop time.

ON: Startup time, cooling and heating temperature setpoints can be configured.

OFF: Operation stop time, cooling and heating setback temperature setpoints can be configured.

( --: Indicates that the setback function is disabled for this time period. )

\_\_: Indicates that the temperature setpoint and setback temperature setpoint for this time period is not specified. The last active setpoint will be utilized.



### Reference

Refer to Setback function on page 67 for details of setback function (FFQ series only).

#### ■ Setting the schedule

# 1

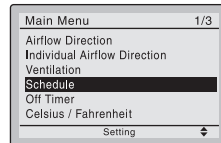

- Press **Menu/OK** button to display the main menu screen.
- Press **▼▲** buttons to select **Schedule**. Press **Menu/OK** button to display the schedule screen.

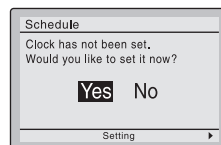
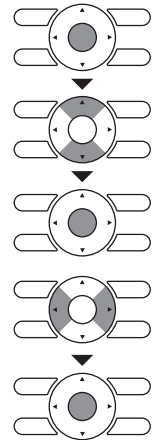

- Before setting the schedule, the clock must be set.
- If the clock has not been set, a screen like the one on the left will appear. Press **◀▶** buttons to select **Yes** and press **Menu/OK** button.

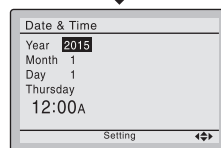

- The date & time screen will appear.
- Set the current year, month, day, and time.

# 2

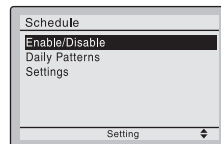

- Press **▼▲** buttons to select the desired function on the schedule screen and press **Menu/OK** button.

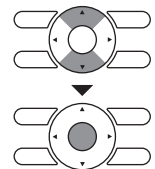

(R24369)

■ Daily Patterns

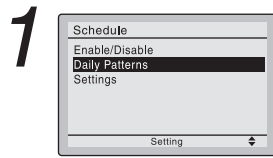

- The schedule screen will appear.
- Press ▼▲ buttons to select **Daily Patterns** on the schedule screen. The daily patterns screen will appear when **Menu/OK** button is pressed.

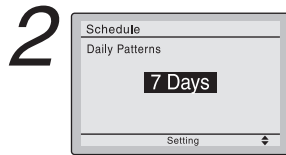
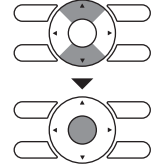

- Press ▼▲ buttons to select **7 Days**, **Weekday/Sat/Sun**, **Weekday/Weekend** or **Everyday** on the daily patterns screen. The confirmation screen will appear when **Menu/OK** button is pressed.

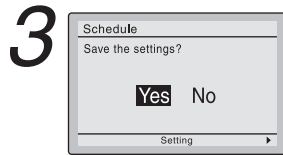
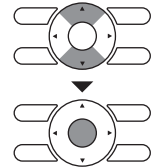

- Press ◀▶ buttons to select **Yes** on the confirmation screen. Pressing **Menu/OK** button enters the daily patterns in the schedule and takes you back to the main menu screen.

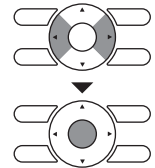

(R24074)

■ Settings

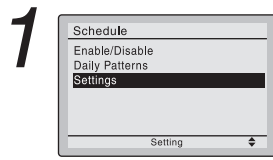

- The schedule screen will appear.
- Press ▼▲ buttons to select **Settings** on the schedule screen. The settings screen will appear when **Menu/OK** button is pressed.

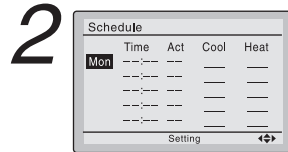
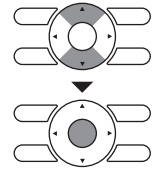

- Press ▼▲ buttons to select the day to be set.

\* It cannot be selected in the case of **EVDY**.

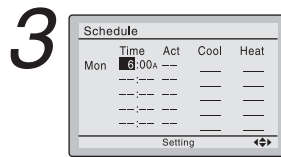
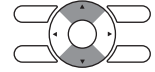

- Input the time for the selected day.
- Press ◀▶ buttons to move the highlighted item and press ▼▲ buttons to input the desired operation start time. Each press of ▼▲ buttons moves the numbers by 1 hour or 1 minute.

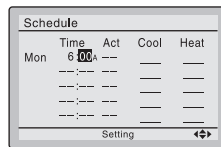
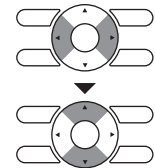

R4003456

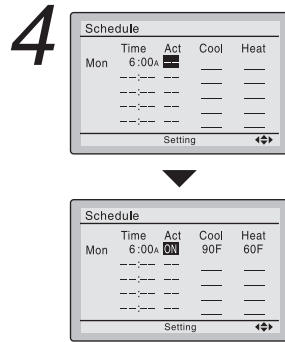

- Press ◀▶ buttons to move the highlighted item and press ▼▲ buttons to configure ON/OFF/-- settings. --, ON, or OFF changes in sequence when ▼▲ buttons are pressed.

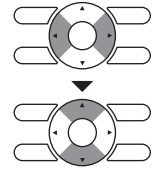

- ON: The temperature setpoints can be configured.
- OFF: The setback temperature setpoints can be configured.
- : The temperature setpoints and setback temperature setpoints become disabled.

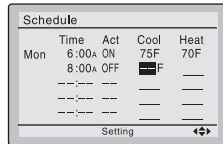

- The cooling and heating temperature setpoints for both ON and OFF (Setback) are configured.

- \_: Indicates that the temperature setpoint and setback temperature setpoint for this time period is not specified. The last active setpoint will be utilized.
- : Indicates that the setback function is disabled for this time period.

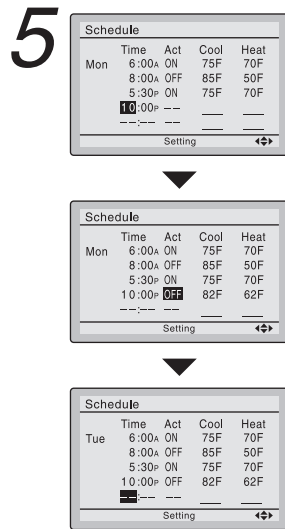

A maximum of five actions per day can be set.

- Press **Menu/OK** button when settings for each day are completed. The confirmation screen will appear.

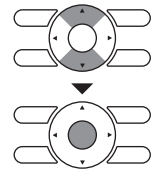

To copy the settings for the previous day, press **Mode** button so that the existing settings will be copied.

Example: The contents for Monday are copied by pressing **Mode** button after selecting Tuesday.

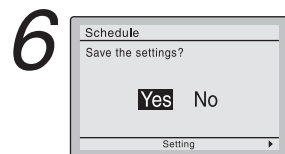

- Press ◀▶ buttons to select **Yes** on the confirmation screen. Pressing **Menu/OK** button confirms the settings for each day and takes you back to the basic screen.

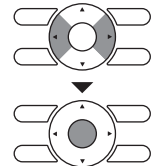

(R24075)

### ■ Enabling or disabling the schedule

- 1**

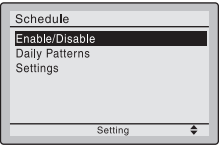
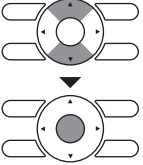
  - Display the schedule screen.
  - Press ▼▲ buttons to select **Enable / Disable** on the schedule screen. Press **Menu/OK** button to display the enable/disable screen.
- 2**

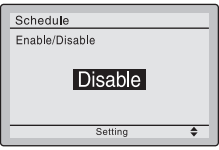
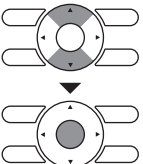
  - Press ▼▲ buttons to select **Enable** or **Disable** on the enable/disable screen. Press **Menu/OK** button after selecting the item. The confirmation screen is displayed.
- 3**

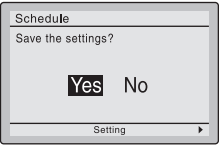
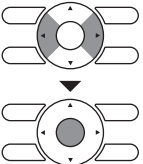
  - Press ◀▶ buttons to select **Yes** on the confirmation screen. Pressing **Menu/OK** button confirms the enable/disable setting for the schedule and takes you back to the basic screen.

R4003458

## 3.6 Setback Function (With BRC1E73)

### Applicable Models

FFQ09/12/15/18W2VJU9

### Outline

The Setback function can be used to maintain the space temperature in an assigned range for an unoccupied period.

### Details

The setback icon flashes on the LCD of wired remote controller when the unit is turned on by the setback control.

- When enabled, the Setback mode becomes active when the indoor unit is turned off by either the user, a schedule event or an off timer.
- Setback function is not available by default. It can be enabled by the system installer.

### 3.7 Drain Pump Control

#### Normal Operation

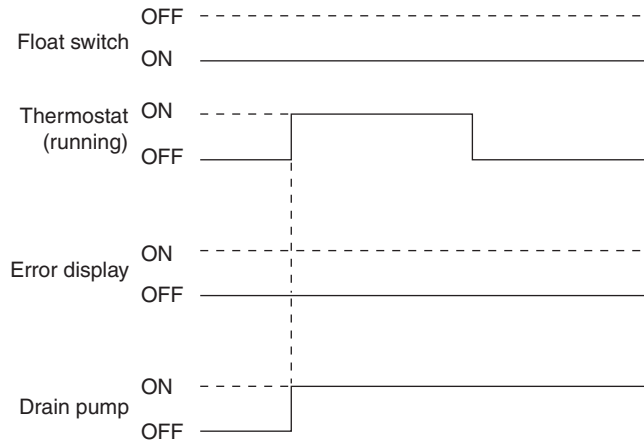

(R24037)

- The float switch is ON in normal operation.
- When cooling operation starts (thermostat ON), the drain pump turns ON simultaneously.
- After the thermostat turns OFF, the drain pump continues to operate.

#### If Float Switch is OFF with Thermostat ON in Cooling Operation

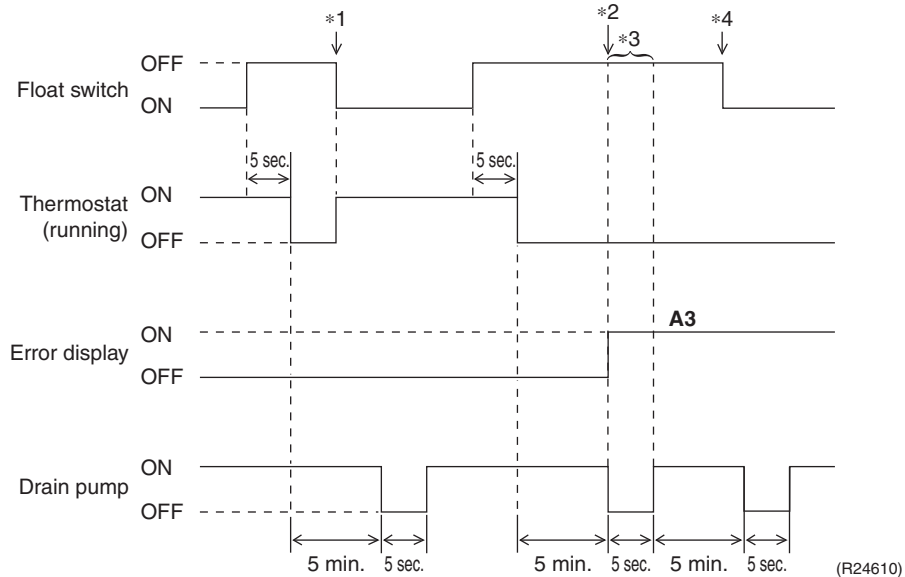

(R24610)

- When the float switch stays OFF for 5 sec., the thermostat turns OFF.
  - After the thermostat turns OFF, the drain pump continues to operate for another 5 minutes.
- \*1. If the float switch turns ON again during the residual operation of the drain pump, cooling operation also turns on again (thermostat ON).
  - \*2. If the float switch remains OFF even after the residual operation of the drain pump has ended, the error code **A3** is determined.
  - \*3. The drain pump turns OFF once residual operation has ended, then turns ON again after 5 seconds.
  - \*4. After **A3** is determined and the unit comes to an abnormal stop, the thermostat will remain OFF even if the float switch turns ON again.



### 3.8 Hot Start Control (In Heating Operation Only)

**Outline**

At startup with thermostat ON or after the completion of defrosting in heating operation, the indoor unit fan is controlled to prevent cold air from blasting out and ensure startup capacity.

**Details**

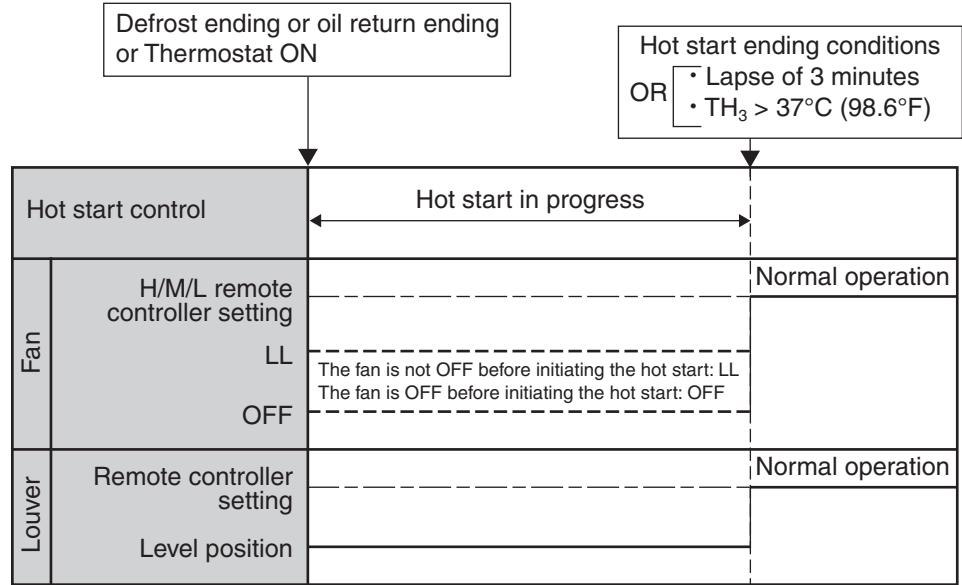

R4003450  
 TH<sub>3</sub>: Temperature detected by the indoor heat exchanger thermistor (R3T)



## 3.9 Presence and Floor Sensors (Option)

### Applicable Models

FFQ09/12/15/18W2VJU9

### Outline

With the human presence signal and the floor temperature signal from the optional sensor kit, the system provides the energy saving control, or the comfortable temperature control and airflow direction control preventing the direct draft to the human.

To use sensor related functions, a wired remote controller (BRC1E73) and optional sensor kit (BRYQ60A2W(S)) are necessary to be installed.

### Details

#### 1. Draft prevention (with presence sensor)

When the sensor detects human presence during auto-swing operation, the system sets the airflow direction parallel to the floor (position 0) to reduce unpleasant draft.

The operation returns to the normal auto-swing as the sensor detects no human in the room.

- Draft prevention is enabled only when decoration panel BYFQ60C2W1W(S), sensor kit BRYQ60A2W(S) and wired remote controller BRC1E73 are connected to the main unit and draft prevention is set to “enabled” on the wired remote controller.
- Factory setting is “disabled”.
- Draft prevention cannot be activated when individual flap control is set, even if draft prevention is enabled on the wired remote controller.

#### Setting on the wired remote controller

1

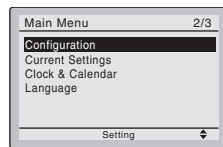

- Press **Menu/OK** button to display the main menu screen.
- Press **▼▲** buttons to select **Configuration** and press **Menu/OK** button.

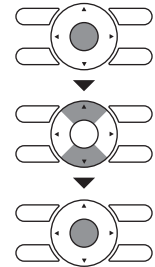

2

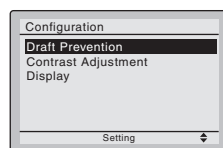

- Press **▼▲** buttons to select **Draft Prevention** and press **Menu/OK** button.

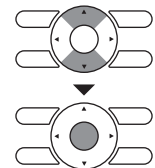

3

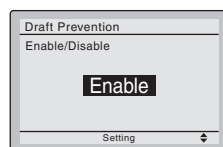

- Press **▼▲** buttons to select **Enable**.
- The confirmation screen will appear when **Menu/OK** button is pressed.

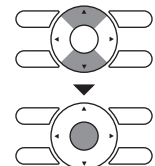

4

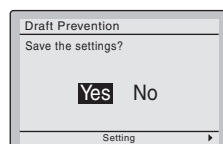

- Press **◀▶** buttons to select **Yes**.
- Press **Menu/OK** button to confirm the settings and to return to the basic screen.

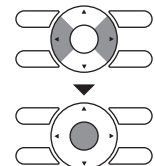

R4003392

### 2. Auto-setback by sensor (with presence sensor)

After pre-determined time has elapsed without detection of human presence, the unit automatically shifts the target temperature gradually for energy saving.

The target temperature displayed on the remote controller remains same as the initial set value during the above change of target temperature.

The target temperature shifts within the range of the highest programmable temperature while in cooling operation and the lowest programmable temperature while in heating operation.

Upon human detection, the target temperature returns to the original setting.

- Auto-setback by sensor is enabled only when decoration panel BYFQ60C2W1W(S), sensor kit BRYQ60A2W(S) and wired remote controller BRC1E73 are connected to the main unit and auto-setback by sensor is set to “enabled” on the wired remote controller.
- Factory setting is “disabled”.

#### Setting on the remote controller

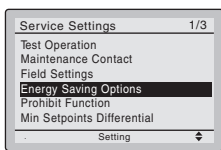
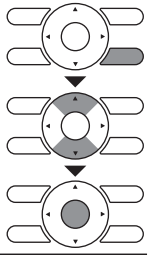
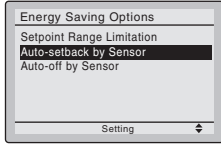
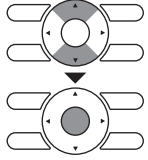
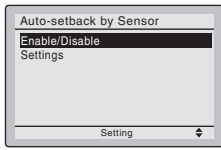
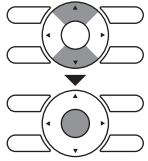
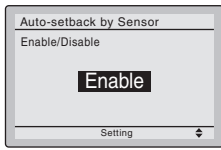
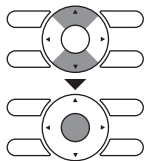
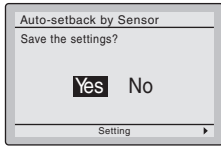
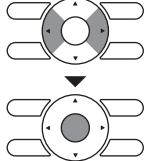
1		<ul style="list-style-type: none"> <li>• Press <b>Cancel</b> button for 4 seconds on the basic screen to display Service Settings menu.</li> <li>• Press <b>▼▲</b> buttons to select <b>Energy Saving Options</b>.</li> <li>• Press <b>Menu/OK</b> button to display Energy Saving Options menu.</li> </ul>	
2		<ul style="list-style-type: none"> <li>• Press <b>▼▲</b> buttons to select <b>Auto-setback by Sensor</b>.</li> <li>• Press <b>Menu/OK</b> button to display Auto-setback by Sensor menu.</li> </ul>	
3		<ul style="list-style-type: none"> <li>• Press <b>▼▲</b> buttons to select <b>Enable/Disable</b>.</li> <li>• Press <b>Menu/OK</b> button.</li> </ul>	
4		<ul style="list-style-type: none"> <li>• Press <b>▼▲</b> buttons to select <b>Enable</b>.</li> <li>• Press <b>Menu/OK</b> button after selecting the item. Then the confirmation screen is displayed.</li> </ul>	
5		<ul style="list-style-type: none"> <li>• Press <b>◀▶</b> buttons to select <b>Yes</b>.</li> <li>• Press <b>Menu/OK</b> button to confirm the settings and to return to the Service Settings menu.</li> </ul>	

R4003390

### 3. Auto-off by sensor (with presence sensor)









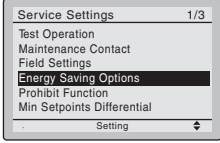

After pre-determined time has elapsed without detection of human presence, the unit automatically stops operation.

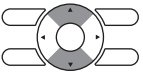
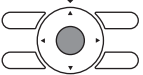
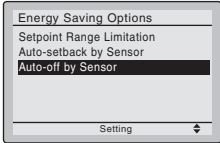
The auto-off time can be set between 1- 24 hours by the hour.

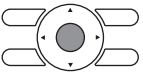
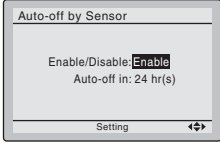
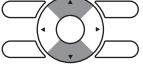
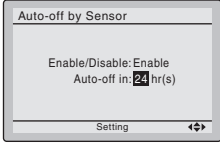
Once the unit stops operation by auto-off function, the system would not restart even if the human is detected again.

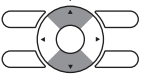
- Auto-off by sensor is enabled only when decoration panel BYFQ60C2W1W(S), sensor kit BRYQ60A2W(S) and wired remote controller BRC1E73 are connected to the main unit and auto-off by sensor is set to “enabled” on the wired remote controller.
- Factory setting is “disabled”.

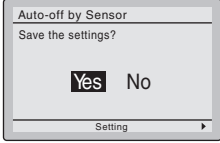
#### Setting on the remote controller

1		<ul style="list-style-type: none"> <li>• Press <b>Cancel</b> button for 4 seconds on the basic screen to display Service Settings menu.</li> <li>• Press <b>▼▲</b> buttons to select <b>Energy Saving Options</b>.</li> <li>• Press <b>Menu/OK</b> button to display Energy Saving Options menu.</li> </ul>	  
2		<ul style="list-style-type: none"> <li>• Press <b>▼▲</b> buttons to select <b>Auto-off by Sensor</b>.</li> <li>• Press <b>Menu/OK</b> button to display Auto-off by Sensor menu.</li> </ul>	 
3		<ul style="list-style-type: none"> <li>• Press <b>▼▲</b> buttons to select <b>Enable</b>.</li> </ul>	
4		<ul style="list-style-type: none"> <li>• Press <b>◀▶</b> buttons to go into the auto-off time setting.</li> <li>• Press <b>▼▲</b> buttons to set auto-off hour(s) (1 ~ 24).</li> <li>• Press <b>Menu/OK</b> button. Then the confirmation screen is displayed.</li> </ul>	  
5		<ul style="list-style-type: none"> <li>• Press <b>◀▶</b> buttons to select <b>Yes</b>.</li> <li>• Press <b>Menu/OK</b> button to confirm the settings and to return to the Service Settings menu.</li> </ul>	 

R4003391

**4. Room temperature adjustment by sensing (with floor sensor)**

The system uses living space temperature calculated from temperatures detected by room temperature thermistor (suction air thermistor in the indoor unit) and floor sensor, as the target temperature.

Operation becomes more optimized by using not only suction air temperature but floor temperature.

- This function is enabled when decoration panel BYFQ60C2WAW(S) and sensor kit BRYQ60A2W(S) is connected to the main unit.

**3.10 Other Functions**

**3.10.1 Signal Receiving Sign**

When the indoor unit receives a signal from the remote controller, the unit emits a signal receiving sound.

**3.10.2 Auto-restart Function**

If a power failure (even a momentary one) occurs during the operation, the system restarts automatically in the same conditions as before when the power supply is restored to the conditions prior to the power failure.



**Note**

It takes 3 minutes to restart the operation because 3-minute standby function is activated.

**3.10.3 Emergency Operation Switch (With Wireless Remote Controller)**

**Outline**

When the wireless remote controller does not work due to battery failure or the absence thereof, use the emergency operation switch.

**Details**

**Start**

Press emergency operation switch.

- The indoor unit runs in the previous operation mode.
- The system operates with the previously set airflow direction (FFQ series only).

**Stop**

Press emergency operation switch again.

**FDMQ Series**

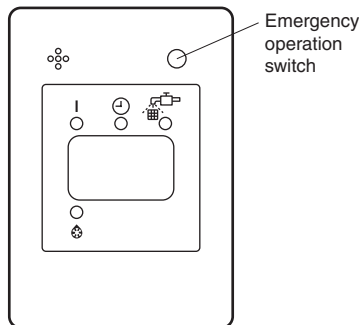

(R24925)

FFQ Series

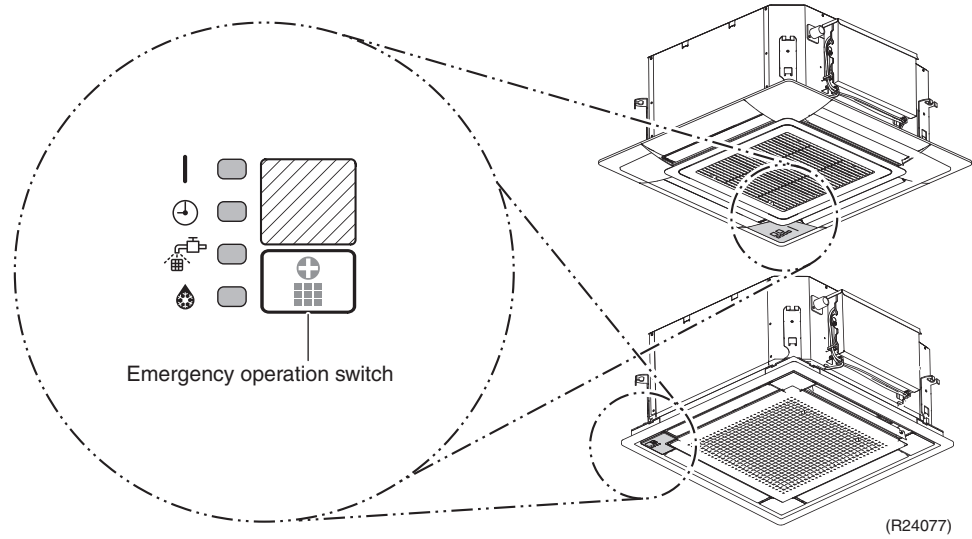

## 4. Thermistor Functions

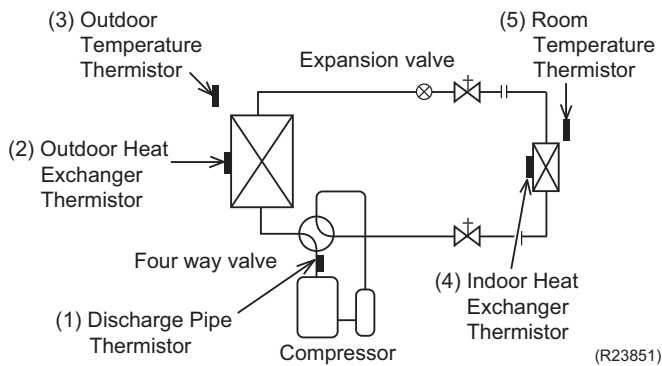

### (1) Discharge Pipe Thermistor

- The discharge pipe thermistor is used for controlling discharge pipe temperature. If the discharge pipe temperature (used in place of the inner temperature of the compressor) rises abnormally, the operating frequency becomes lower or the operation halts.
- The discharge pipe thermistor is used for detecting disconnection of the discharge pipe thermistor.

### (2) Outdoor Heat Exchanger Thermistor

- The outdoor heat exchanger thermistor is used for controlling the target discharge pipe temperature. The system sets the target discharge pipe temperature according to the outdoor and indoor heat exchanger temperature, and controls the electronic expansion valve opening so that the target discharge pipe temperature can be obtained.
- In cooling operation, the outdoor heat exchanger thermistor is used for detecting the disconnection of the discharge pipe thermistor. When the discharge pipe temperature drops below the outdoor heat exchanger temperature by more than a certain value, the discharge pipe thermistor is judged as disconnected.
- In cooling operation, the outdoor heat exchanger thermistor is used for high pressure protection.

### (3) Outdoor Temperature Thermistor

- The outdoor temperature thermistor detects the outdoor air temperature and is used for refrigerant shortage detection, input current control, outdoor fan control, liquid compression protection function, and so on.

### (4) Indoor Heat Exchanger Thermistor

- The indoor heat exchanger thermistor is used for controlling the target discharge pipe temperature. The system sets the target discharge pipe temperature according to the outdoor and indoor heat exchanger temperature, and controls the electronic expansion valve opening so that the target discharge pipe temperature can be obtained.
- In cooling operation, the indoor heat exchanger thermistor is used for freeze-up protection control. If the indoor heat exchanger temperature drops abnormally, the operating frequency becomes lower or the operation halts.
- In heating operation, the indoor heat exchanger thermistor is used for detecting the disconnection of the discharge pipe thermistor. When the discharge pipe temperature drops below the indoor heat exchanger temperature by more than a certain value, the discharge pipe thermistor is judged as disconnected.

### (5) Room Temperature Thermistor

- The room temperature thermistor detects the room air temperature and is used for controlling the room air temperature.

## 5. Control Specification

### 5.1 Mode Hierarchy

#### Outline

The air conditioner control has normal operation mode, forced operation mode, and power transistor test mode for installation and servicing.

#### Details

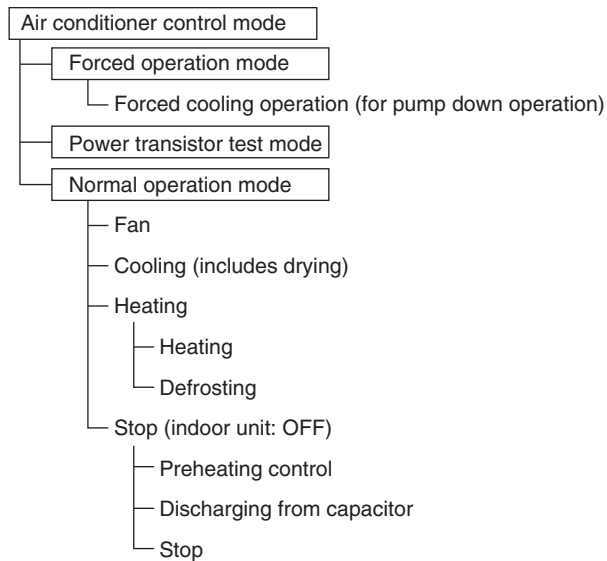

(R22375)



**Note(s)** Unless specified otherwise, dry operation command is regarded as cooling operation.

### 5.2 Frequency Control

#### Outline

The compressor frequency is determined according to the difference between the room thermistor temperature and the target temperature.

When the shift of the frequency is less than zero ( $\Delta F < 0$ ) by PI control, the target frequency is used as the command frequency.

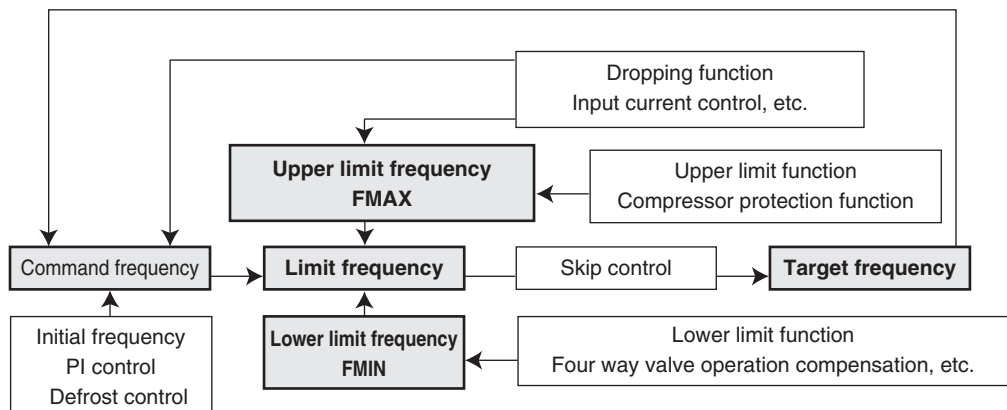

(R18023)

**Details****1. Determine command frequency**

Command frequency is determined in the following order of priority.

- (1) Limiting defrost control time
- (2) Forced cooling
- (3) Indoor frequency command

**2. Determine upper limit frequency**

The minimum value is set as an upper limit frequency among the frequency upper limits of the following functions:

Compressor protection, input current, discharge pipe temperature, heating peak-cut, freeze-up protection, defrost control.

**3. Determine lower limit frequency**

The maximum value is set as a lower limit frequency among the frequency lower limits of the following functions:

Four way valve operation compensation, draft prevention, pressure difference upkeep.

**4. Determine prohibited frequency**

There is a certain prohibited frequency such as a power supply frequency.

**Initial Frequency**

When starting the compressor, the frequency is initialized according to the  $\Delta D$  value of the indoor unit.

 **$\Delta D$  signal: Indoor frequency command**

The difference between the room thermistor temperature and the target temperature is taken as the  $\Delta D$  value and is used for  $\Delta D$  signal of frequency command.

 **$\Delta D$  signal for cooling**

Temperature difference	$\Delta D$ signal	Temperature difference	$\Delta D$ signal	Temperature difference	$\Delta D$ signal	Temperature difference	$\Delta D$ signal
-2.0°C (-3.6°F)	*OFF	0°C (0°F)	4	2.0°C (3.6°F)	8	4.0°C (7.2°F)	12
-1.5°C (-2.7°F)	1	0.5°C (0.9°F)	5	2.5°C (4.5°F)	9	4.5°C (8.1°F)	13
-1.0°C (-1.8°F)	2	1.0°C (1.8°F)	6	3.0°C (5.4°F)	10	5.0°C (9.0°F)	14
-0.5°C (-0.9°F)	3	1.5°C (2.7°F)	7	3.5°C (6.3°F)	11	5.5°C (9.9°F)	15

\*OFF = Thermostat OFF

 **$\Delta D$  signal for heating**

Temperature difference	$\Delta D$ signal	Temperature difference	$\Delta D$ signal	Temperature difference	$\Delta D$ signal	Temperature difference	$\Delta D$ signal
-1.5°C (-2.7°F)	*OFF	0.5°C (0.9°F)	4	2.5°C (4.5°F)	8	4.5°C (8.1°F)	12
-1.0°C (-1.8°F)	1	1.0°C (1.8°F)	5	3.0°C (5.4°F)	9	5.0°C (9.0°F)	13
-0.5°C (-0.9°F)	2	1.5°C (2.7°F)	6	3.5°C (6.3°F)	10	5.5°C (9.9°F)	14
0°C (0°F)	3	2.0°C (3.6°F)	7	4.0°C (7.2°F)	11	6.0°C (10.8°F)	15

\*OFF = Thermostat OFF



**PI Control****1. P control**

The  $\Delta D$  value is calculated in each sampling time (20 seconds), and the frequency is adjusted according to its difference from the frequency previously calculated.

**2. I control**

If the operating frequency does not change for more than a certain fixed time, the frequency is adjusted according to the  $\Delta D$  value.

When  $\Delta D$  value is low, the frequency is lowered.

When  $\Delta D$  value is high, the frequency is increased.

**3. Frequency control when other controls are functioning**

- When frequency is dropping:

Frequency control is carried out only when the frequency drops.

- For limiting lower limit:

Frequency control is carried out only when the frequency rises.

**4. Upper and lower limit of frequency by PI control**

The frequency upper and lower limits are set according to the command of the indoor unit.

When the indoor unit quiet or QUIET OUTDOOR UNIT operation command comes from the indoor unit, the upper limit frequency is lower than the usual setting.

## 5.3 Controls at Mode Changing/Start-up

### 5.3.1 Preheating Control

**Outline**

The inverter operation in open phase starts with the conditions of the outdoor temperature, the discharge pipe temperature, the radiation fin temperature and the preheating command from the indoor unit.

**Details**

Outdoor temperature  $\geq -2.5^{\circ}\text{C}$  ( $27.5^{\circ}\text{F}$ ) Control A (preheating for normal state)

Outdoor temperature  $< -2.5^{\circ}\text{C}$  ( $27.5^{\circ}\text{F}$ ) Control B (preheating of increased capacity)

**Control A**

- ON condition

Discharge pipe temperature  $< 0^{\circ}\text{C}$  ( $32.0^{\circ}\text{F}$ )

Radiation fin temperature  $< 85^{\circ}\text{C}$  ( $185^{\circ}\text{F}$ )

- OFF condition

Discharge pipe temperature  $> 2^{\circ}\text{C}$  ( $35.6^{\circ}\text{F}$ )

Radiation fin temperature  $\geq 90^{\circ}\text{C}$  ( $194^{\circ}\text{F}$ )

**Control B**

- ON condition

Discharge pipe temperature  $< 10^{\circ}\text{C}$  ( $50.0^{\circ}\text{F}$ )

Radiation fin temperature  $< 85^{\circ}\text{C}$  ( $185^{\circ}\text{F}$ )

- OFF condition

Discharge pipe temperature  $> 12^{\circ}\text{C}$  ( $53.6^{\circ}\text{F}$ )

Radiation fin temperature  $\geq 90^{\circ}\text{C}$  ( $194^{\circ}\text{F}$ )

### 5.3.2 Four Way Valve Switching

#### Outline

The four way valve coil is energized/not energized depending on the operation mode.  
(Heating: ON, Cooling/Dry/Defrost: OFF)

In order to eliminate the switching sound as the four way valve coil switches from ON to OFF when the heating is stopped, the OFF delay switch of the four way valve is carried out.

#### Details

##### OFF delay switch of four way valve

The four way valve coil is energized for 160 seconds after the operation is stopped.

### 5.3.3 Four Way Valve Operation Compensation

#### Outline

At the beginning of operation as the four way valve is switched, the pressure difference to activate the four way valve is acquired when the output frequency is higher than a certain fixed frequency, for a certain fixed time.

#### Details

##### Starting Conditions

1. When the compressor starts and the four way valve switches from OFF to ON
2. When the four way valve switches from ON to OFF during operation
3. When the compressor starts after resetting
4. When the compressor starts after the fault of four way valve switching

The lower limit of frequency keeps **A** Hz for **B** seconds for any of the conditions above.

When the outdoor temperature is above **C** in heating, the frequency decreases depending on the outdoor temperature.

	09/12 class		15/18/24 class	
	Cooling	Heating	Cooling	Heating
<b>A</b> (Hz)	40	54	48	
<b>B</b> (seconds)	60		70	
<b>C</b>	(°C)	10	15	
	(°F)	50	59	

### 5.3.4 3-Minute Standby

Turning on the compressor is prohibited for 3 minutes after turning off.

The function is not used when defrosting.

### 5.3.5 Compressor Protection Function

When turning the compressor from OFF to ON, the upper limit of frequency is set as follows. The function is not used when defrosting.

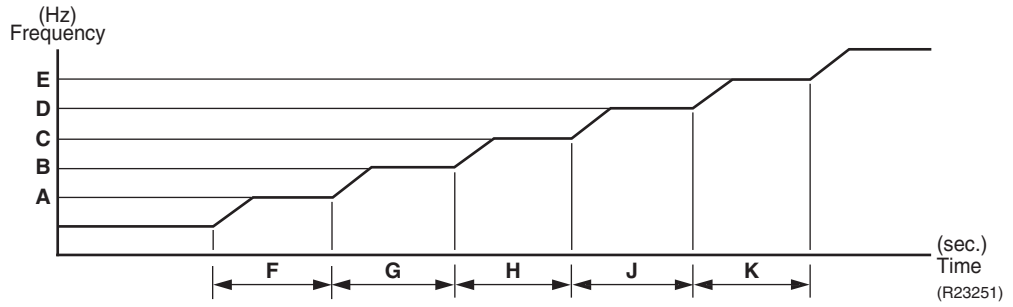

	09/12 class	15/18/24 class
<b>A</b> (Hz)	40	52
<b>B</b> (Hz)	54	68
<b>C</b> (Hz)	72	80
<b>D</b> (Hz)	90	—
<b>E</b> (Hz)	—	—
<b>F</b> (seconds)	180	300
<b>G</b> (seconds)	420	200
<b>H</b> (seconds)	180	460
<b>J</b> (seconds)	120	—
<b>K</b> (seconds)	—	—

## 5.4 Discharge Pipe Temperature Control

**Outline**

The discharge pipe temperature is used as the internal temperature of the compressor. If the discharge pipe temperature rises above a certain level, the upper limit of frequency is set to keep the discharge pipe temperature from rising further.

**Details**

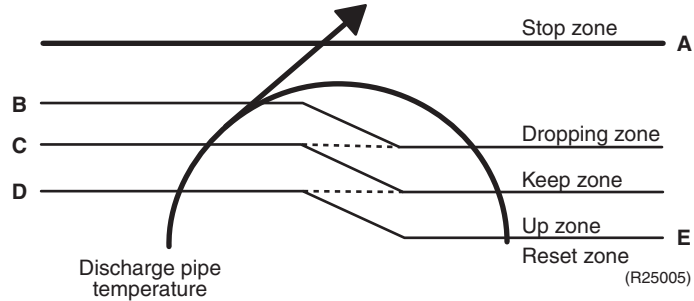

Zone	Control
Stop zone	When the temperature reaches the stop zone, the compressor stops.
Dropping zone	The upper limit of frequency decreases.
Keep zone	The upper limit of frequency is kept.
Up zone	The upper limit of frequency increases.
Reset zone	The upper limit of frequency is canceled.

	09/12 class		15/18/24 class	
	(°C)	(°F)	(°C)	(°F)
<b>A</b>	110	230.0	110	230.0
<b>B</b>	103	217.4	103	217.4
<b>C</b>	98	208.4	101.5	214.7
<b>D</b>	93	199.4	100	212.0
<b>E</b>	88	190.4	95	203.0

## 5.5 Input Current Control

### Outline

The microcomputer calculates the input current while the compressor is running, and sets the frequency upper limit based on the input current.

In case of heat pump models, this control is the upper limit control of the frequency and takes priority over the lower limit control of four way valve operation compensation.

### Details

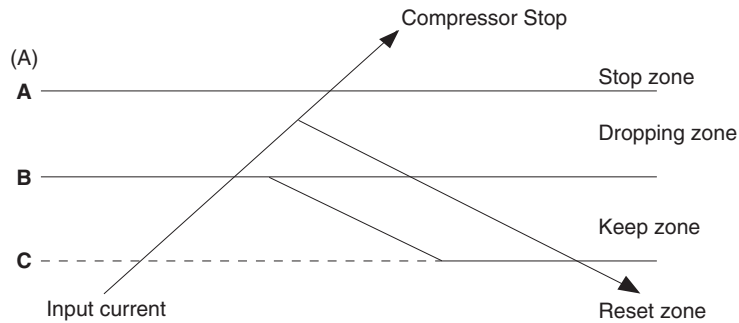

(R23249)

#### Frequency control in each zone

##### Stop zone

- After the input current remains in the stop zone for 2.5 seconds, the compressor is stopped.

##### Dropping zone

- The upper limit of the compressor frequency is defined as operation frequency – 2 Hz.
- After this, the output frequency is lowered by 2 Hz every second until it reaches the keep zone.

##### Keep zone

- The present maximum frequency goes on.

##### Reset zone

- Limit of the frequency is canceled.

	09/12 class		15 class		18 class		24 class	
	Cooling	Heating	Cooling	Heating	Cooling	Heating	Cooling	Heating
<b>A (A)</b>	12		12		12	12.5	18	
<b>B (A)</b>	7	7.5	8		10	10.75	12	11.5
<b>C (A)</b>	6	6.5	7		9	9.75	11	10.5

#### Limitation of current dropping and stop value according to the outdoor temperature

- The current drops when outdoor temperature becomes higher than a certain level (depending on the model).

## 5.6 High Pressure Protection Control

**Outline**

In order to prevent abnormal high pressures in the system and hence avoiding activation of the high pressure safety device the below control function will be activated.

**Details**

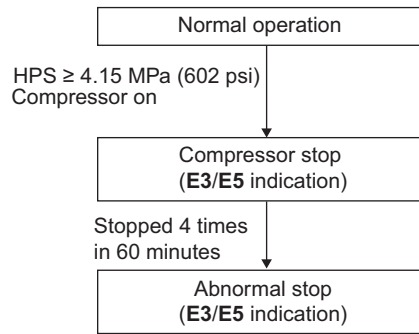
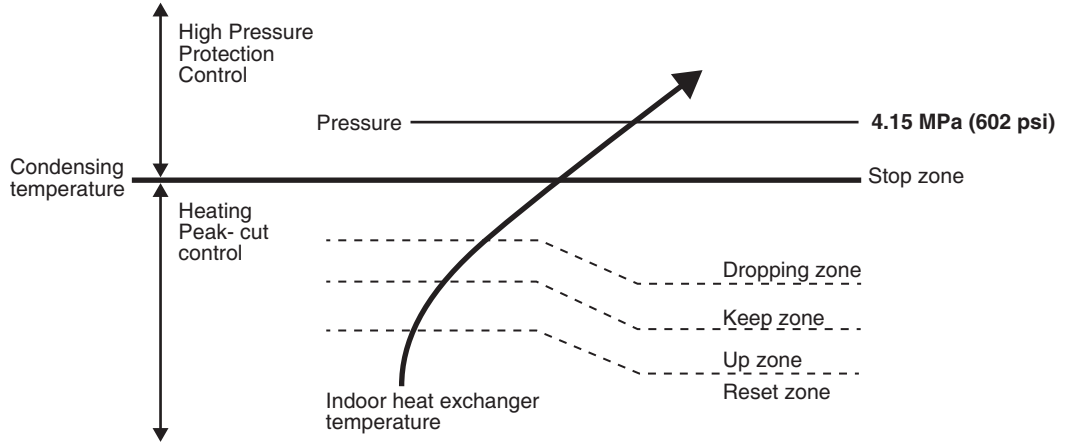

## 5.7 Freeze-up Protection Control

### Outline

During cooling operation, the signal sent from the indoor unit determines the frequency upper limit and prevents freezing of the indoor heat exchanger. The signals from the indoor unit are divided into zones.

### Details

#### ■ FTXR

The operating frequency limitation is judged with the indoor heat exchanger temperature.

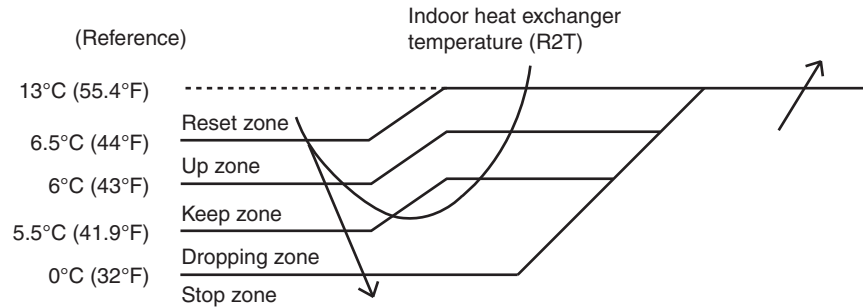

R4003563

#### ■ FDMQ

When the freeze-up protection control starts, the compressor stops, the airflow rate is fixed to L tap, and the drain pump turns ON. Conditions for starting and ending are as below.

#### Starting conditions

The freeze-up protection control starts when any of the following conditions is satisfied.

- The indoor heat exchanger temperature remains at **A** or lower for 1 minute.
- The accumulated time that the indoor heat exchanger temperature remains at **B** or lower reaches 40 minutes.

#### Accumulated timer clearing condition

- The indoor heat exchanger temperature remains at **C** or higher for 20 minutes.

#### Ending condition

- The indoor heat exchanger temperature remains at **D** or higher for 10 minutes.

	(°C)	(°F)
<b>A</b>	-5	23.0
<b>B</b>	-1	30.2
<b>C</b>	4	39.2
<b>D</b>	7	44.6

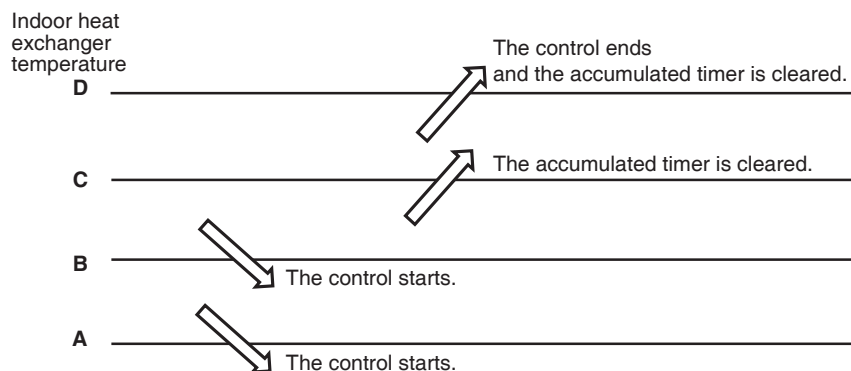

R4003915

■ FFQ

The operating frequency limitation is judged with the indoor heat exchanger temperature.

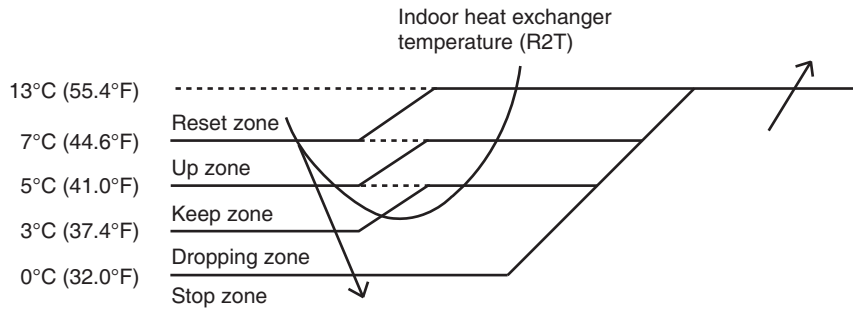

R4003916

## 5.8 Heating Peak-cut Control

During heating operation, the indoor heat exchanger temperature determines the frequency upper limit to prevent abnormal high pressure.

The operating frequency limitation is judged with the indoor heat exchanger temperature.

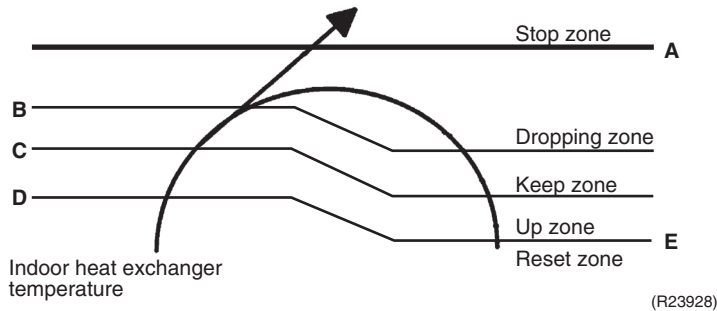

(R23928)

Zone	Control
Stop zone	When the temperature reaches the stop zone, the compressor stops.
Dropping zone	The upper limit of frequency decreases.
Keep zone	The upper limit of frequency is kept.
Up zone	The upper limit of frequency increases.
Reset zone	The upper limit of frequency is canceled.

	09/12 class		15 class		18 class		24 class	
	(°C)	(°F)	(°C)	(°F)	(°C)	(°F)	(°C)	(°F)
<b>A</b>	57.5	135.5	60	140.0	60	140.0	60	140.0
<b>B</b>	55	131.0	54	129.2	55	131.0	54	129.2
<b>C</b>	52	125.6	51	123.8	52	125.6	51	123.8
<b>D</b>	50	122.0	49	120.2	50	122.0	49	120.2
<b>E</b>	45	113.0	44	111.2	45	113.0	44	111.2



## 5.9 Outdoor Fan Control

1. **Fan ON control to cool down the electrical box**  
The outdoor fan is turned ON when the electrical box temperature is high while the compressor is OFF.
2. **Fan OFF control during defrosting**  
The outdoor fan is turned OFF while defrosting.
3. **Fan OFF delay when stopped**  
The outdoor fan is turned OFF 60 ~ 70 seconds after the compressor stops.
4. **Fan speed control for pressure difference upkeep**  
The rotation speed of the outdoor fan is controlled for keeping the pressure difference during cooling operation with low outdoor temperature.
  - When the pressure difference is low, the rotation speed of the outdoor fan is reduced.
  - When the pressure difference is high, the rotation speed of the outdoor fan is controlled as well as normal operation.
5. **Fan speed control during forced operation**  
The outdoor fan is controlled as well as normal operation during forced operation.
6. **Fan speed control during POWERFUL operation**  
The rotation speed of the outdoor fan is increased during POWERFUL operation.
7. **Fan speed control during indoor unit quiet/QUIET OUTDOOR UNIT operation**  
The rotation speed of the outdoor fan is reduced by the command of the indoor unit quiet/QUIET OUTDOOR UNIT operation.
8. **Fan ON/OFF control when operation (cooling, heating, dry) starts/stops**  
The outdoor fan is turned ON when the operation starts. The outdoor fan is turned OFF when the operation stops.

## 5.10 Liquid Compression Protection Function

---

<b>Outline</b>	The compressor stops according to the outdoor temperature for protection.
<b>Details</b>	<p>Operation stops depending on the outdoor temperature.</p> <p>The compressor turns off under the conditions that the system is in cooling operation and the outdoor temperature is below 0°C (32°F).</p> <p>However, the cooling operation range can be extended to the lowest temperature of -20°C (-4°F) by changing facility setting. Refer to page 224 for details of facility setting.</p>

---

# 5.11 Defrost Control

**Outline**

Defrosting is carried out by the cooling cycle (reverse cycle). The defrosting time or outdoor heat exchanger temperature must be more than a certain value to finish defrosting.

**Details**

**Conditions for Starting Defrost**

- The starting conditions are determined with the outdoor temperature and the outdoor heat exchanger temperature.
- The system is in heating operation.
- The compressor operates for 6 minutes.
- More than **A** minutes (depending on the duration of the previous defrost control) of accumulated time have passed since the start of the operation, or ending the previous defrosting.

**Conditions for Canceling Defrost**

The judgment is made with the outdoor heat exchanger temperature (**B**).

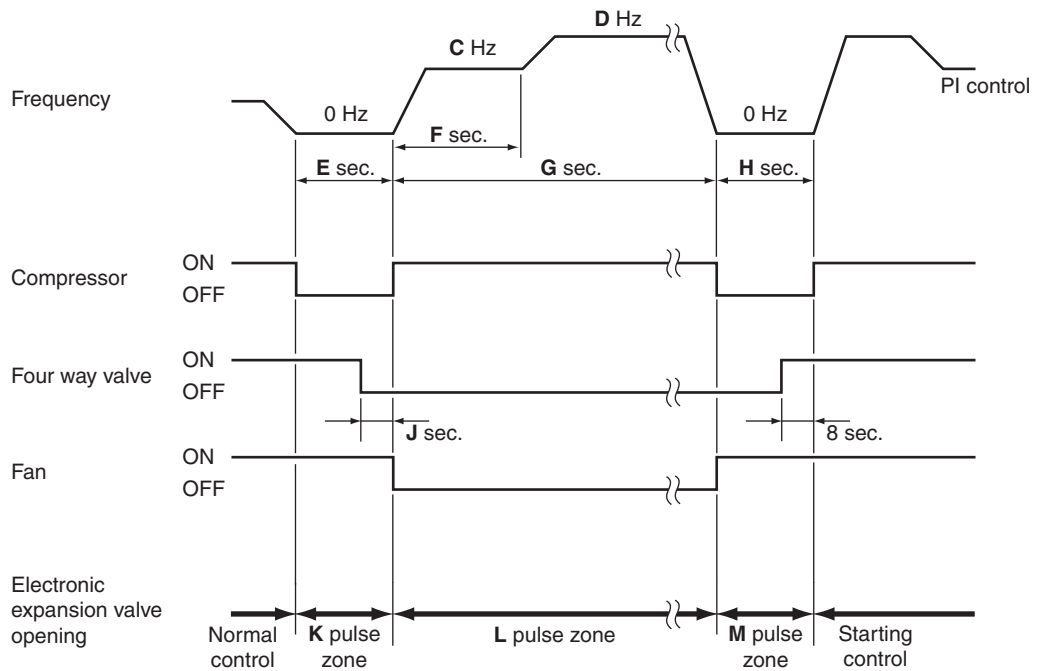

(R21661)

	09/12 class	15/18 class	24 class
<b>A</b> (minute)	20 ~ 25	44	44
<b>B</b>	(°C)	2 ~ 20	6 ~ 12
	(°F)	35.6 ~ 68.0	42.8 ~ 53.6
<b>C</b> (Hz)	64	48	48
<b>D</b> (Hz)	64	70	70
<b>E</b> (seconds)	40	60	60
<b>F</b> (seconds)	60	60	60
<b>G</b> (seconds)	120 ~ 630	120 ~ 460	120 ~ 460
<b>H</b> (seconds)	50	60	90
<b>J</b> (seconds)	8	5	5
<b>K</b> (pulse)	400	450	450
<b>L</b> (pulse)	300	300 ~ 450	300 ~ 450
<b>M</b> (pulse)	350	300	200

## 5.12 Electronic Expansion Valve Control

### Outline

The following items are included in the electronic expansion valve control.

#### Electronic expansion valve is fully closed

1. Electronic expansion valve is fully closed when turning on the power.
2. Pressure equalizing control

#### Open Control

1. Electronic expansion valve control when starting operation
2. Electronic expansion valve control when the frequency changes
3. Electronic expansion valve control for defrosting
4. Electronic expansion valve control when the discharge pipe temperature is abnormally high
5. Electronic expansion valve control when the discharge pipe thermistor is disconnected

#### Feedback Control

Target discharge pipe temperature control

### Details

The followings are the examples of electronic expansion valve control for each operation mode.

	Power on ; Compressor stop	Operation start	Frequency change under starting control	During target discharge pipe temperature control	Frequency change under target discharge pipe temperature control	Discharge pipe thermistor disconnection	Frequency change under discharge pipe thermistor disconnection control	During defrost control
Starting operation control	—	●	—	—	—	—	—	—
Control when the frequency changes	—	—	●	—	●	—	—	—
Target discharge pipe temperature control	—	—	—	●	—	—	—	—
Discharge pipe thermistor disconnection control	—	—	—	—	—	●	●	—
High discharge pipe temperature control	—	●	●	●	●	—	—	—
Defrost control (heating only)	—	—	—	—	—	—	—	●
Pressure equalizing control	●	—	—	—	—	—	—	—
Opening limit control	—	●	●	●	●	●	●	—

- : Available
- : Not available

R4003560

### 5.12.1 Initialization as Power Supply On

The electronic expansion valve is initialized (fully closed) when the power is turned on. Then, the valve opening position is set and the pressure is equalized.

### 5.12.2 Pressure Equalizing Control

When the compressor is stopped, the pressure equalizing control is activated. The electronic expansion valve opens, and develops the pressure equalization.

### 5.12.3 Opening Limit Control

The maximum and minimum opening of the electronic expansion valve are limited.

	09/12 class	1518/24 class
Maximum opening (pulse)	470	480
Minimum opening (pulse)	32	52

The electronic expansion valve is fully closed when cooling operation stops, and is opened at a fixed degree during defrosting.

### 5.12.4 Starting Operation Control

The electronic expansion valve opening is controlled when the operation starts, thus preventing superheating or liquid compression.

### 5.12.5 Control when the Frequency Changes

When the target discharge pipe temperature control is active, if the target frequency changes to a specified value in a certain time period, the target discharge pipe temperature control is canceled and the target opening of the electronic expansion valve is changed according to the frequency shift.

### 5.12.6 High Discharge Pipe Temperature Control

When the compressor is operating, if the discharge pipe temperature exceeds a certain value, the electronic expansion valve opens and the refrigerant runs to the low pressure side. This procedure lowers the discharge pipe temperature.

## 5.12.7 Discharge Pipe Thermistor Disconnection Control

### Outline

The disconnection of the discharge pipe thermistor is detected by comparing the discharge pipe temperature with the condensation temperature. If the discharge pipe thermistor is disconnected, the electronic expansion valve opens according to the outdoor temperature and the operation frequency, operates for a specified time, and then stops.

After 3 minutes, the operation restarts and checks if the discharge pipe thermistor is disconnected. If the discharge pipe thermistor is disconnected, the system stops after operating for a specified time.

If the disconnection is detected repeatedly, the system is shut down. When the compressor runs for 60 minutes without any error, the error counter is reset.

### Details

#### Determining thermistor disconnection

When the starting control finishes, the detection timer for disconnection of the discharge pipe thermistor (**A** seconds) starts. When the timer is over, the following adjustment is made.

1. When the operation mode is cooling

When the following condition is fulfilled, the discharge pipe thermistor disconnection is ascertained.

Discharge pipe temperature +6°C (+10.8°F) < outdoor heat exchanger temperature

2. When the operation mode is heating

When the following condition is fulfilled, the discharge pipe thermistor disconnection is ascertained.

Discharge pipe temperature +6°C (+10.8°F) < indoor heat exchanger temperature

	09/12 class	15/18/24 class
<b>A</b> (seconds)	720	540

#### When the thermistor is disconnected

When the disconnection is ascertained, the compressor continues operation for 9 minutes and then stops.

If the compressor stops repeatedly, the system is shut down.

### 5.12.8 Target Discharge Pipe Temperature Control

The target discharge pipe temperature is obtained from the indoor and outdoor heat exchanger temperature, and the electronic expansion valve opening is adjusted so that the actual discharge pipe temperature becomes close to the target discharge pipe temperature. (Indirect SH (superheating) control using the discharge pipe temperature)

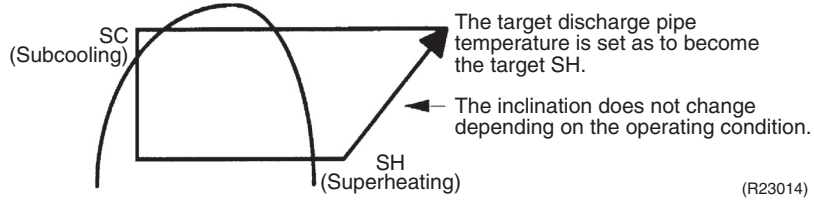

(R23014)

The electronic expansion valve opening and the target discharge pipe temperature are adjusted every **A** seconds. The opening degree of the electronic expansion valve is adjusted by the following.

- Target discharge pipe temperature
- Actual discharge pipe temperature
- Previous discharge pipe temperature

	All outdoor units
<b>A</b> (seconds)	10 ~ 30★

★ The time depends on the opening of the electronic expansion valve.

## 5.13 Malfunctions

### 5.13.1 Sensor Malfunction Detection

Sensor malfunction can be detected in the following thermistor:

1. Outdoor heat exchanger thermistor
2. Discharge pipe thermistor
3. Radiation fin thermistor
4. Outdoor temperature thermistor

### 5.13.2 Detection of Overcurrent and Overload

**Outline**

An excessive output current is detected and the OL temperature is observed to protect the compressor.

**Details**

- If the OL (compressor head) temperature exceeds 130°C (266°F) (depending on the model), the system shuts down the compressor.
- If the inverter current exceeds 12.0 ~ 20.0 A (depending on the model), the system shuts down the compressor.  
The upper limit of the current decreases when the outdoor temperature exceeds a certain level.

# Part 5

# Remote Controller

1. Applicable Remote Controller .....	94
2. ARC466A36 .....	95
3. BRC082A43 .....	97
4. BRC082A41W, BRC082A42W(S).....	99
5. BRC944B2 .....	101
6. BRC1E73 .....	102

# 1. Applicable Remote Controller

Type	Model Name	Wireless R/C	Reference Page	Wired R/C	Reference Page
Wall Mounted	FTXR09WVJUW9	ARC466A36	95	BRC944B2 (option)	101
	FTXR09WVJUS9				
	FTXR12WVJUW9				
	FTXR12WVJUS9				
	FTXR18WVJUW9				
	FTXR18WVJUS9				
Duct Concealed	FDMQ09WVJU9	BRC082A43	97	BRC1E73	102
	FDMQ12WVJU9				
	FDMQ15WVJU9				
	FDMQ18WVJU9				
	FDMQ24WVJU9				
Ceiling Cassette	FFQ09W2VJU9	BRC082A41W BRC082A42W(S)	99		
	FFQ12W2VJU9				
	FFQ15W2VJU9				
	FFQ18W2VJU9				



## Note

Refer to the operation manual of applicable model for details. You can download operation manuals from Daikin Business Portal:

Daikin Business Portal → Document Search → Item Category → Installation/Operation Manual  
(URL: [https://global1d.daikin.com/business\\_portal/login/](https://global1d.daikin.com/business_portal/login/))



## 2. ARC466A36

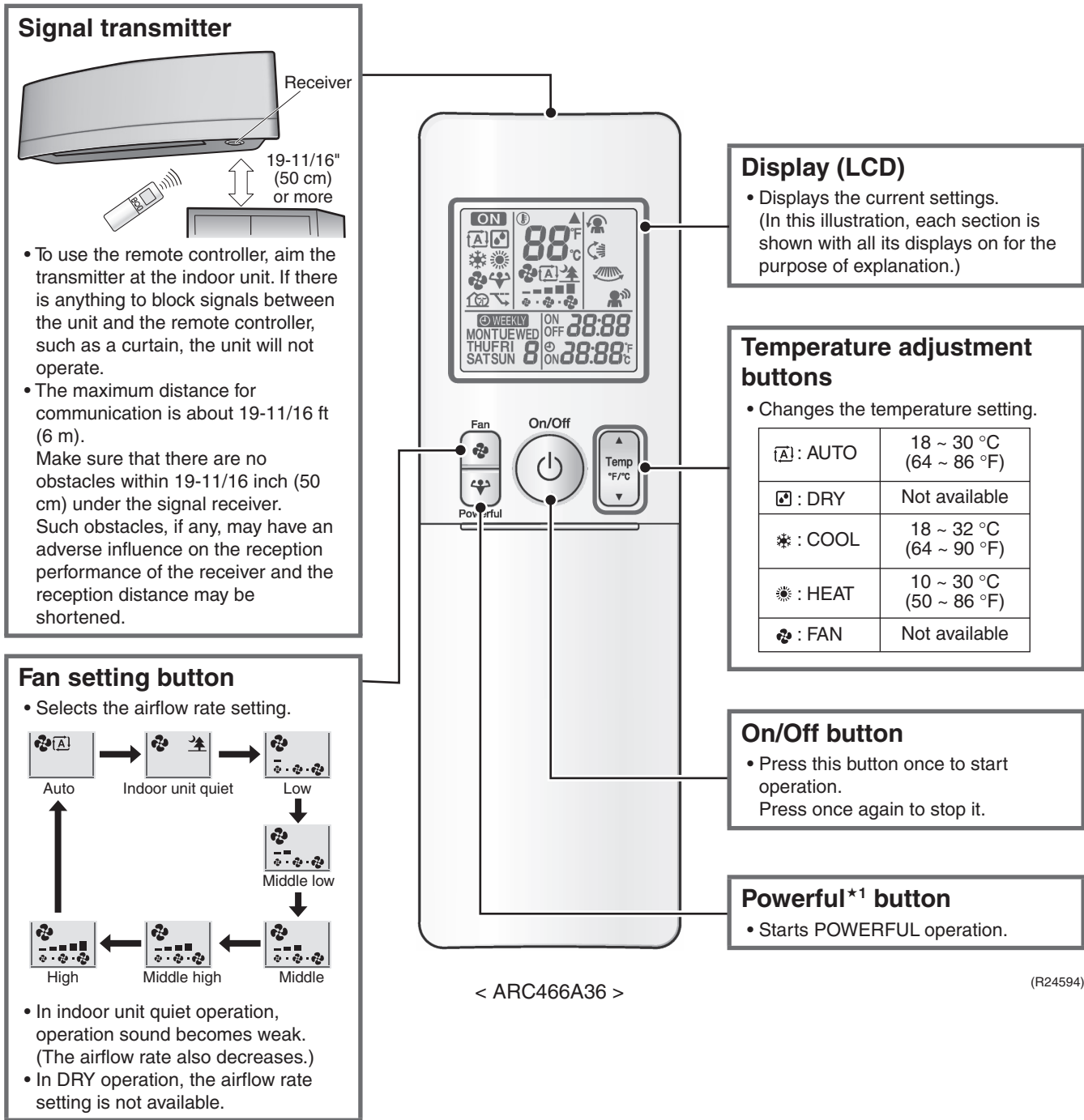

(R24594)



**Reference**

Refer to the following pages for details.

★1 POWERFUL Operation      P.48

Open the Front Cover

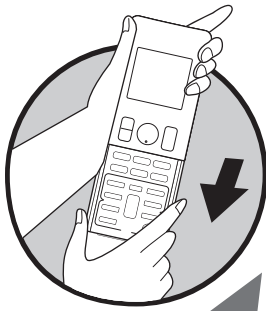

**Mode button**

- Selects the operation mode.

**Lamp brightness setting button**

- Each time you press **Brightness** button, the brightness of the indoor unit display changes to high, low, or off.

**Comfort/Sensor button (COMFORT AIRFLOW Operation<sup>\*2</sup>/ INTELLIGENT EYE Operation<sup>\*3</sup>)**

- Every time you press **Comfort/Sensor** button, the setting changes in the following order.

**Off Timer button (NIGHT SET mode)**

- Press this button and adjust the day and time with **Select** button.
- Press this button again to complete TIMER setting.

**Timer Cancel button**

- Cancels the timer setting.
- It cannot be used for the WEEKLY TIMER operation.

**Select button**

- Changes the ON/OFF TIMER and WEEKLY TIMER settings.

**Clock<sup>\*7</sup> button**

**On Timer button**

- Press this button and adjust the day and time with **Select** button.
- Press this button again to complete TIMER setting.

**Econo<sup>\*4</sup> / Quiet button**

- Every time you press **Econo/Quiet** button, the setting changes in the following order.

- QUIET OUTDOOR UNIT operation is not available in FAN and DRY operation.
- QUIET OUTDOOR UNIT operation and ECONO operation cannot be used at the same time with POWERFUL operation. Priority is given to the function you pressed last.

**Swing<sup>\*5</sup> buttons**

- Adjusts the airflow direction.
- When you press **Swing** button, the flap moves up and down, or (and) the louver moves right and left. The flap (louver) stops when you press **Swing** button again.

**Weekly button (WEEKLY TIMER Operation<sup>\*6</sup>)**

- Weekly
- : Weekly button
- : Program button
- Copy
- : Copy button
- Back
- : Back button
- Next
- : Next button

(R24616)

**Reference** Refer to the following pages for details.

★2 COMFORT AIRFLOW operation	P.40, 41	★5 Auto-swing	P.40
★3 2-area INTELLIGENT EYE operation	P.46	★6 WEEKLY TIMER operation	P.51
★4 ECONO operation	P.45	★7 Clock setting	P.50

### 3. BRC082A43

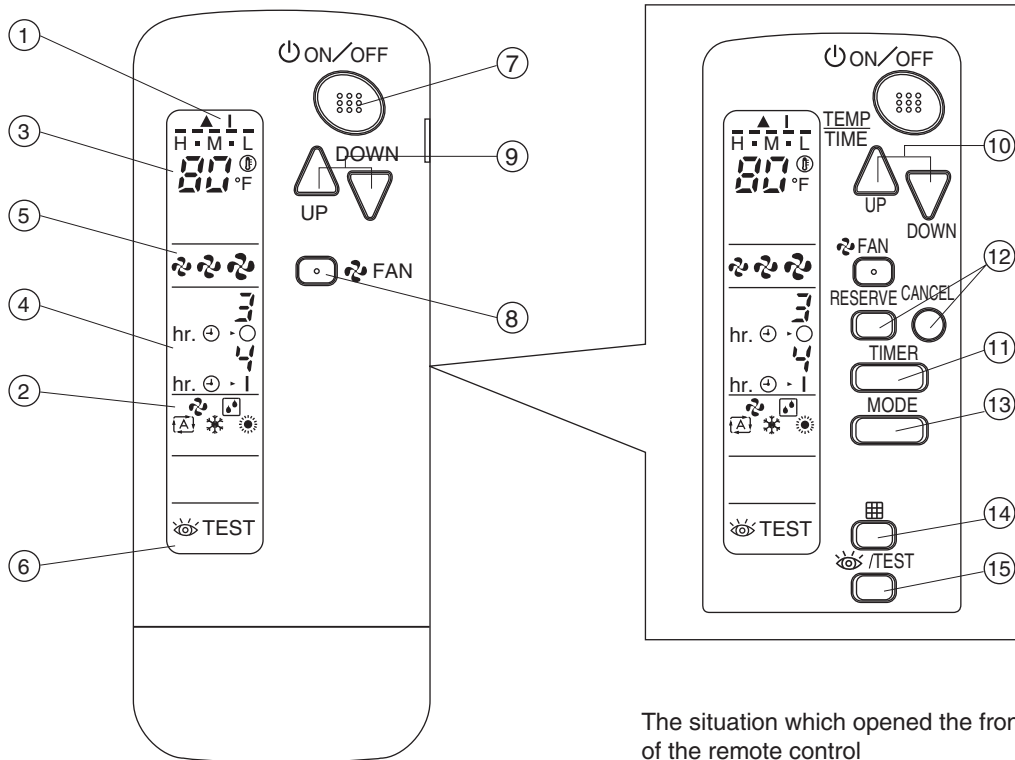





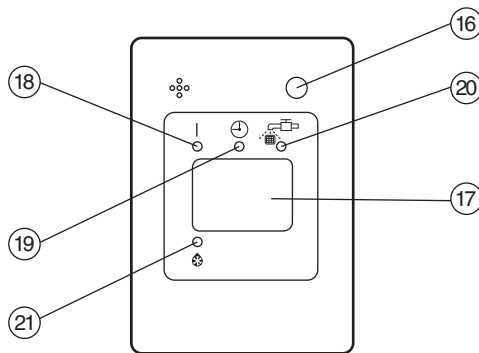







The situation which opened the front cover of the remote control

(R25006)



(R25007)

1	<b>DISPLAY “▲” “I” (SIGNAL TRANSMISSION)</b>	
	This lights up when a signal is being transmitted.	
2	<b>DISPLAY “” “” “” “” “3</b>	<b>DISPLAY “” (SET TEMPERATURE)</b>
	This display shows the set temperature.	
4	<b>DISPLAY “ hr.  hr.” (PROGRAMMED TIME)</b>	
	This display shows PROGRAMMED TIME of the system start or stop.	
5	<b>DISPLAY “” “” “” (FAN SPEED)</b>	
	This display shows the set fan speed.	
6	<b>DISPLAY “ TEST” (INSPECTION/ TEST OPERATION)</b>	
	When the INSPECTION/TEST OPERATION BUTTON is pressed, the display shows the system mode is in.	
7	<b>ON/OFF BUTTON</b>	
	Press the button and the system will start. Press the button again and the system will stop.	
8	<b>FAN SPEED CONTROL BUTTON</b>	
	Press this button to select the fan speed (HIGH, MEDIUM or LOW) of your choice.	
9	<b>TEMPERATURE SETTING BUTTON</b>	
	Use this button for SETTING TEMPERATURE. (Operates with the front cover of the remote controller closed.)	
10	<b>PROGRAMMING TIMER BUTTON</b>	
	Use this button for programming “START and/or STOP” time. (Operates with the front cover of the remote controller opened.)	

11	<b>TIMER MODE START/STOP BUTTON</b>
	Use this button for TIMER MODE setting.
12	<b>TIMER RESERVE/CANCEL BUTTON</b>
	Use this button to end timer setting procedure.
13	<b>OPERATION MODE SELECTOR BUTTON</b>
	Press this button to select OPERATION MODE.
14	<b>FILTER SIGN RESET BUTTON</b>
	Refer to the section of MAINTENANCE in the operation manual attached to the indoor unit.
15	<b>INSPECTION/TEST OPERATION BUTTON</b>
	This button is pressed for inspection or test operation. Do not use for normal operation.
16	<b>EMERGENCY OPERATION SWITCH</b>
	This switch is readily used if the remote controller does not work.
17	<b>RECEIVER</b>
	This receives the signals from the remote controller.
18	<b>OPERATING INDICATOR LAMP (Red)</b>
	This lamp stays lit while the air conditioner runs. It flashes when the unit is in trouble.
19	<b>TIMER INDICATOR LAMP (Green)</b>
	This lamp stays lit while the timer is set.
20	<b>AIR FILTER CLEANING TIME INDICATOR LAMP (Red)</b>
	Lights up when it is time to clean the air filter.
21	<b>DEFROST LAMP (Orange)</b>
	Lights up when the defrosting operation has started. (For cooling only type this lamp does not turn on.)



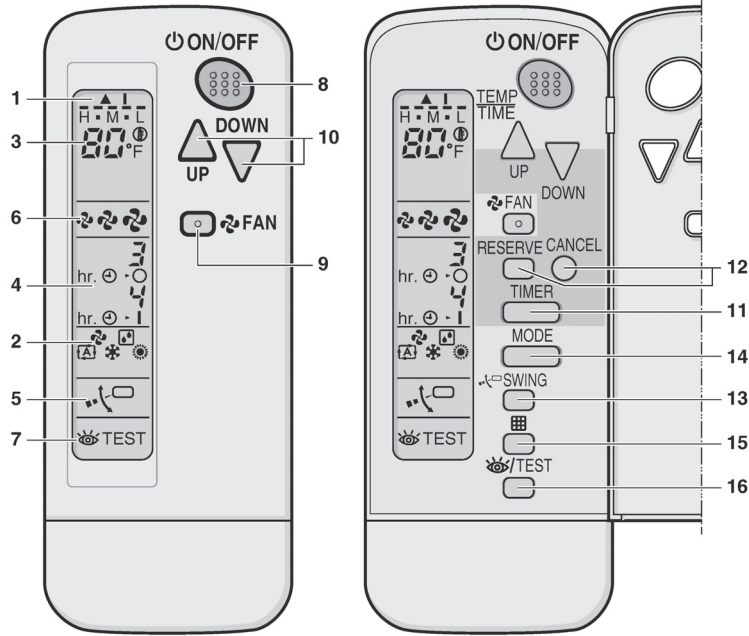



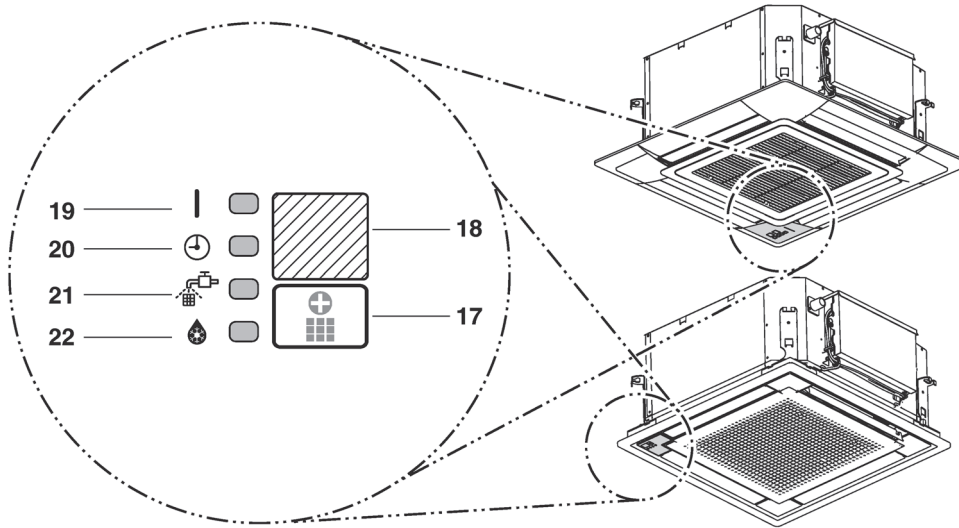



# 4. BRC082A41W, BRC082A42W(S)



(R23936)



(R23937)

1	<b>DISPLAY ▲ (SIGNAL TRANSMISSION)</b> This lights up when a signal is being transmitted.	11	<b>TIMER MODE START/STOP BUTTON</b>
2	<b>DISPLAY , , , ,  (OPERATION MODE)</b> This display shows the current OPERATION MODE.	12	<b>TIMER RESERVE/CANCEL BUTTON</b>
3	<b>DISPLAY <math>H \cdot \bar{M} \cdot L</math>, <math>27.0^{\circ}F</math> (SET TEMPERATURE)</b> This display shows the set temperature.	13	<b>AIRFLOW DIRECTION ADJUST BUTTON</b>
4	<b>DISPLAY <math>hr. \ominus \cdot \bar{3}</math>, <math>hr. \ominus \cdot \bar{4}</math> (PROGRAMMED TIME)</b> This display shows PROGRAMMED TIME of the system start or stop.	14	<b>OPERATION MODE SELECTOR BUTTON</b> Press this button to select OPERATION MODE.
5	<b>DISPLAY  (SWING FLAP)</b>	15	<b>FILTER SIGN RESET BUTTON</b>
6	<b>DISPLAY , ,  (FAN SPEED)</b> The display shows the set fan speed.	16	<b>INSPECTION/TEST OPERATION BUTTON</b> This button is used only by qualified service persons for maintenance purposes.
7	<b>DISPLAY /TEST (INSPECTION/TEST OPERATION)</b> When the <b>INSPECTION/TEST OPERATION</b> button is pressed, the display shows the system mode is in.	17	<b>EMERGENCY OPERATION SWITCH</b> This switch is readily used if the remote controller does not work.
8	<b>ON/OFF BUTTON</b> Press the button and the system will start. Press the button again and the system will stop.	18	<b>RECEIVER</b> This receives the signals from the remote controller.
9	<b>FAN SPEED CONTROL BUTTON</b> Press this button to select the fan speed, LOW, MEDIUM or HIGH, of your choice.	19	<b>OPERATION LAMP (Red)</b> This lamp stays lit while the air conditioner runs. It blinks when the unit is in trouble.
10	<b>TEMPERATURE SETTING BUTTON</b> Use this button for setting temperature.	20	<b>TIMER LAMP (Green)</b> This lamp stays lit while the timer is set.
		21	<b>AIR FILTER CLEANING TIME INDICATOR LAMP (Red)</b> Lights up when it is time to clean the air filter.
		22	<b>DEFROST LAMP (Orange)</b> Lights up when the defrosting operation has started.

R5000166

# 5. BRC944B2

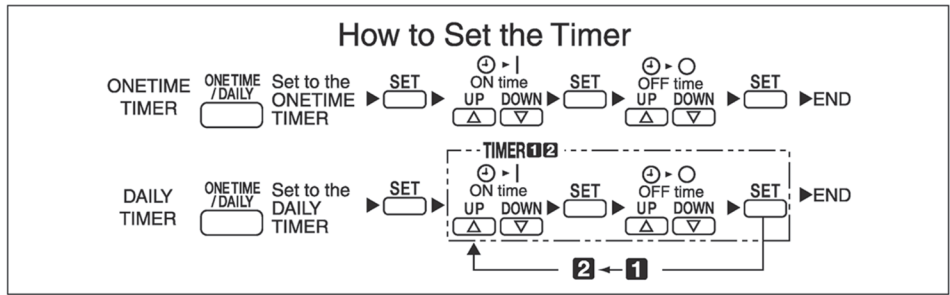
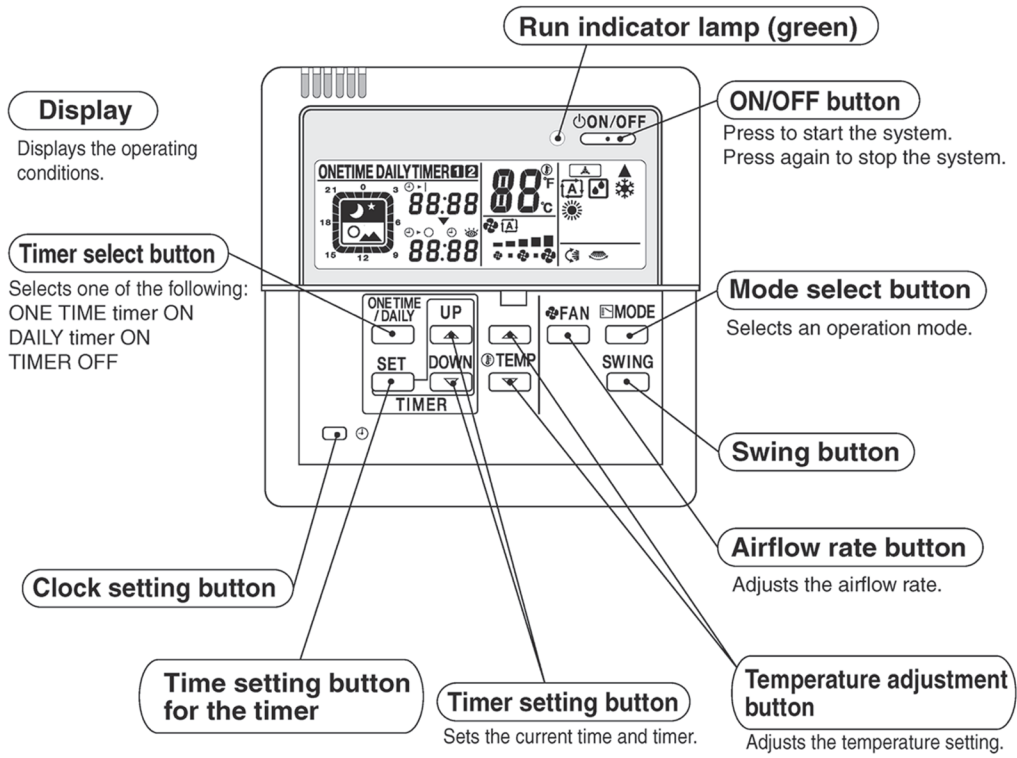

R5000214



**Caution**

This remote controller cannot be used together with a standard wireless remote controller. Otherwise, what appears on this remote controller's display may fail to correspond to actual operating conditions.

# 6. BRC1E73

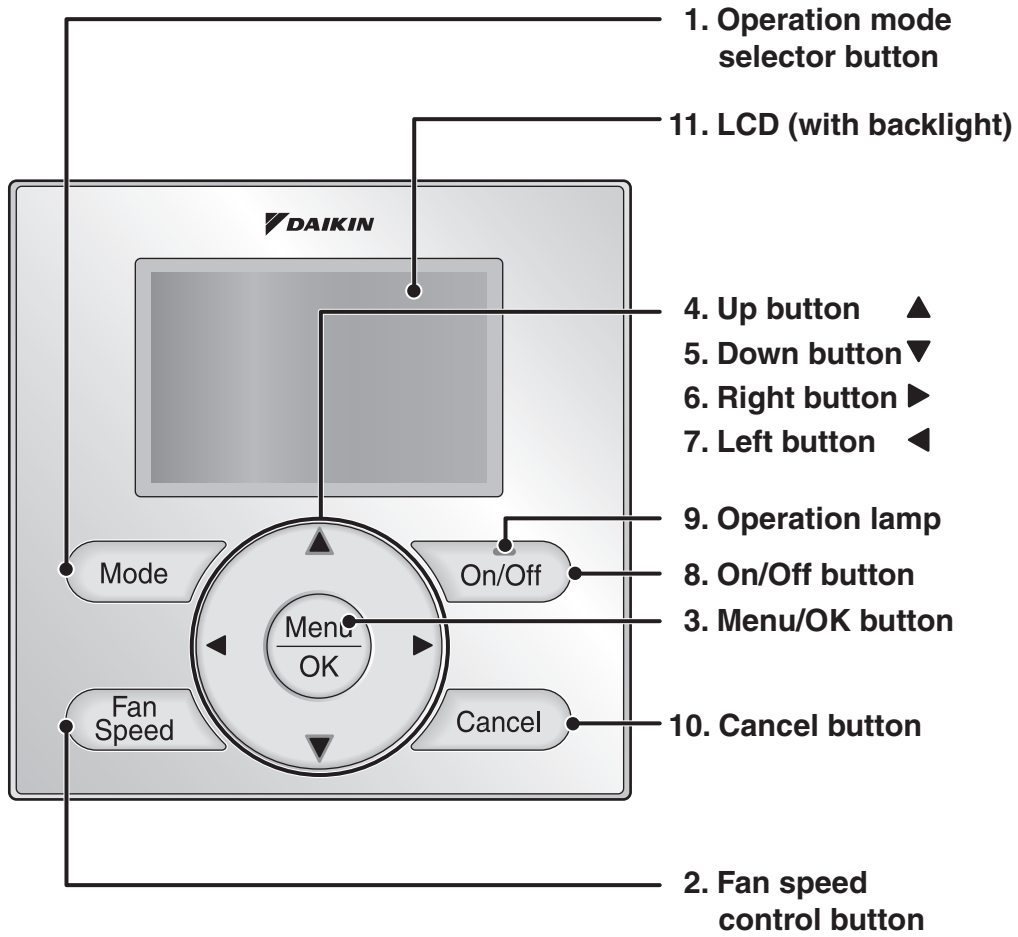



---

**1. Operation mode selector button**

---

- Press this button to select the operation mode of your preference.  
\* Available modes vary with the indoor unit model.

---

**2. Fan speed control button**

---

- Press this button to select the fan speed of your preference.  
\* Available fan speeds vary with the indoor unit model.

---

**3. Menu/OK button**

---

- Used to enter the main menu.
- Used to enter the selected item.

---

**4. Up button ▲**

---

- Used to raise the setpoint.
- The item above the current selection will be highlighted.  
(The highlighted items will be scrolled continuously when the button is continuously pressed.)
- Used to change the selected item.

---

**5. Down button ▼**

---

- Used to lower the setpoint.
- The item below the current selection will be highlighted.  
(The highlighted items will be scrolled continuously when the button is continuously pressed.)
- Used to change the selected item.

---

**6. Right button ►**

---

- Used to highlight the next items on the right-hand side.
- Each screen is scrolled in the right-hand direction.

---

**7. Left button ◀**

---

- Used to highlight the next items on the left-hand side.
- Each screen is scrolled in the left-hand direction.

---

**8. On/Off button**

---

- Press this button and system will start.
- Press this button again to stop the system.

---

**9. Operation lamp**

---

- This lamp illuminates solid green during normal operation.
- This lamp flashes if an error occurs.

---

**10. Cancel button**

---

- Used to return to the previous screen.

---

**11. LCD (with backlight)**

---

- The backlight will be illuminated for approximately 30 seconds by pressing any button.
- If two remote controllers are used to control a single indoor unit, only the controller accessed first will have backlight functionality.

# Liquid Crystal Display

- Three types of display mode (Standard, Detailed and Simple) are available.
- Standard display is set by default.
- Detailed and Simple displays can be selected in the main menu.

## Standard display

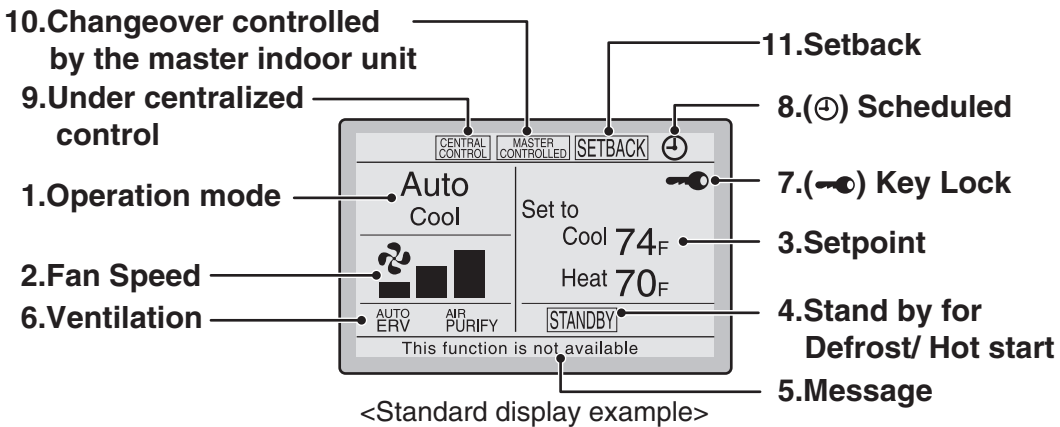

## Detailed display

- The airflow direction, clock, and selectable item appear on Detailed display screen in addition to the items appearing on Standard display.

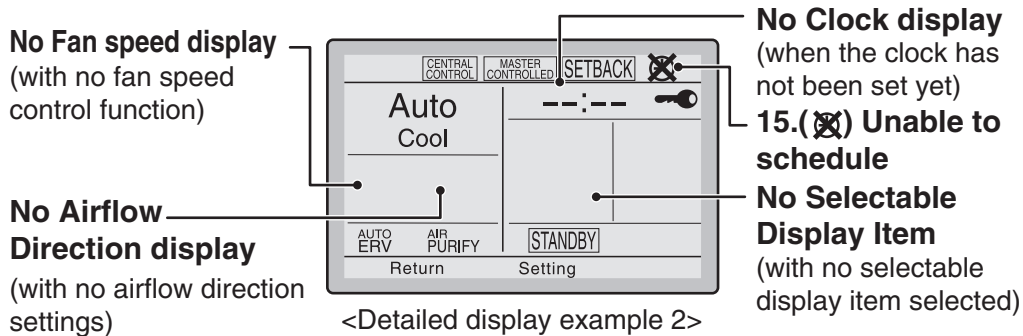
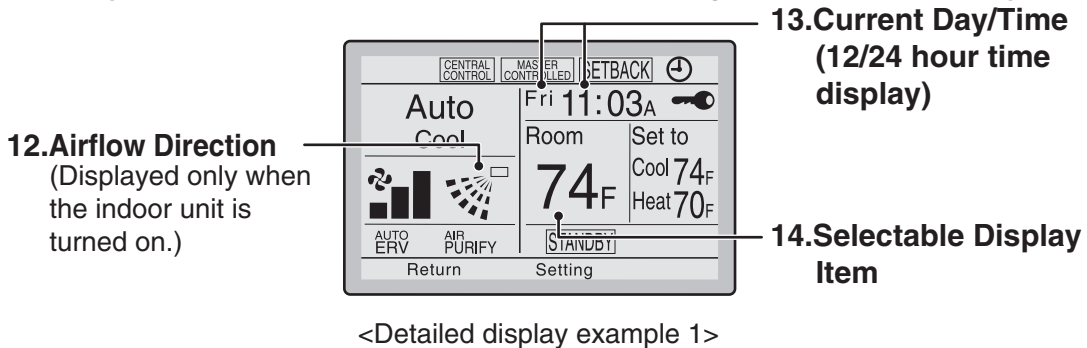

**Simple display**

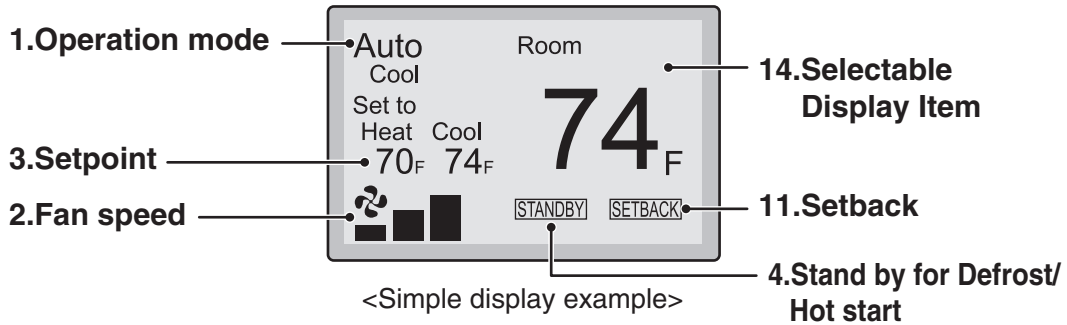

**Note for all display modes**

- Depending on the field settings, while the indoor unit is stopped, OFF may be displayed instead of the operation mode and/or the setpoint may not be displayed.

## 1. Operation mode

---

- Used to display the current operation mode: Cool, Heat, Vent, Fan, Dry or Auto.
- In Auto mode, the actual operation mode (Cool or Heat) will be also displayed.
- Operation mode cannot be changed when OFF is displayed.  
Operation mode can be changed after starting operation.

## 2. Fan Speed

---

- Used to display the fan speed that is set for the indoor unit.
- The fan speed will not be displayed if the connected model does not have fan speed control functionality.

## 3. Setpoint

---

- Used to display the setpoint for the indoor unit.
- Use the Celsius/Fahrenheit item in the main menu to select the temperature unit (Celsius or Fahrenheit).

## 4. Stand by for Defrost/Hot start

“”

**If ventilation icon is displayed in this field:**

- Indicates that an energy recovery ventilator (ERV) is connected.  
For details, refer to the Operation Manual of the ERV.

## 5. Message

---

**The following messages may be displayed.**

“**This function is not available**”

- Displayed for a few seconds when an Operation button is pressed and the indoor unit does not provide the corresponding function.
- In a remote control group, the message will not appear if at least one of the indoor units provides the corresponding function.

“**Error: Push Menu button**”

“**Warning: Push Menu button**”

- Displayed if an error or warning is detected.

“**Time to clean filter**”



“**Time to clean element**”

“**Time to clean filter & element**”

- Displayed as a reminder when it is time to clean the filter and/or element.

## 6. Ventilation

---

- Displayed when an energy recovery ventilator is connected.
- **Ventilation Mode icon.** “ AUTO ERV BYPASS”  
These icons indicate the current ventilation mode (ERV only) (AUTO, ERV, BYPASS).
- **Air Purify ICON** “ AIR PURIFY”  
This icon indicates that the air purifying unit (Optional) is in operation.

## 7. Key Lock

---

- Displayed when the key lock is set.

## 8. Scheduled

---

- Displayed if the Schedule or Off timer is enabled.

## 9. Under Centralized control “”

---

- Displayed if the system is under the management of a multi-zone controller (Optional) and the operation of the system through the remote controller is limited.

## 10. Changeover controlled by the master indoor unit “” (VRV only)

---

- Displayed when another indoor unit on the system has the authority to change the operation mode between cool and heat.

---

**11. Setback “”**

---

- The setback icon flashes when the unit is turned on by the setback control.

---

**12. Airflow Direction “”**

---

- Displayed when the airflow direction and swing are set.
- If the connected indoor unit model does not include oscillating louvers this item will not be displayed.

---

**13. Current Day/Time (12/24 hour time display)**

---

- Displayed if the clock is set.
- If the clock is not set, “-- : --” will be displayed.
- 12 hour time format is displayed by default.
- Select 12/24 hour time display option in the main menu under “Clock & Calendar”.

---

**14. Selectable Display Item**

---

- Room temperature is selected by default.
- For other choices see the operation manual.

---

**15. ~~X~~Unable to schedule**

---

- Displayed when the clock needs to be set.
- The schedule function will not work unless the clock is set.

# Part 6

## Service Diagnosis

1. General Problem Symptoms and Check Items .....	110
2. Troubleshooting with LED .....	111
2.1 Indoor Unit.....	111
2.2 Outdoor Unit.....	113
3. Service Diagnosis .....	114
3.1 ARC466 Series.....	114
3.2 BRC1E73 .....	117
3.3 BRC082A43, BRC082A41W, BRC082A42W(S).....	119
4. Error Codes and Description.....	123
5. Troubleshooting for FTXR Series.....	124
5.1 Indoor Unit PCB Abnormality .....	124
5.2 Freeze-up Protection Control/Heating Peak-cut Control .....	126
5.3 Indoor Fan Motor (DC Motor) or Related Abnormality .....	127
5.4 Thermistor or Related Abnormality.....	130
5.5 Front Panel Open/Close Fault.....	131
5.6 Low-voltage Detection or Over-voltage Detection.....	132
5.7 Signal Transmission Error (Between Indoor Unit and Outdoor Unit).....	134
5.8 Unspecified Voltage (Between Indoor Unit and Outdoor Unit).....	136
6. Troubleshooting for FDMQ, FFQ Series .....	137
6.1 Indoor Unit PCB Abnormality .....	137
6.2 Drain Level Control System Abnormality.....	138
6.3 Indoor Fan Motor or Related Abnormality .....	139
6.4 Indoor Fan PCB Abnormality.....	144
6.5 Humidifier or Related Abnormality.....	145
6.6 Thermistor or Related Abnormality.....	146
6.7 Presence Sensor or Floor Sensor Abnormality .....	147
6.8 Remote Controller Thermistor Abnormality .....	148
6.9 Low-voltage Detection or Over-voltage Detection.....	149
6.10 Signal Transmission Error (Between Indoor and Outdoor Unit).....	151
6.11 Signal Transmission Error (Between Indoor Unit and Remote Controller).....	153
6.12 Signal Transmission Error (Between MAIN/SUB Remote Controllers) ....	154
6.13 Unspecified Voltage (Between Indoor Unit and Outdoor Unit).....	155
7. Troubleshooting for Outdoor Unit.....	156
7.1 Outdoor Unit PCB Abnormality.....	156
7.2 Actuation of High Pressure Switch .....	157
7.3 OL Activation (Compressor Overload) or HPS Activation (High Pressure Switch).....	159
7.4 OL Activation (Compressor Overload) .....	162

---

7.5	Compressor Lock .....	165
7.6	DC Fan Lock .....	166
7.7	Input Overcurrent Detection .....	167
7.8	Four Way Valve Abnormality .....	169
7.9	Discharge Pipe Temperature Control .....	171
7.10	High Pressure Control in Cooling .....	172
7.11	System Shutdown due to Temperature Abnormality in the Compressor .....	174
7.12	Compressor Sensor System Abnormality .....	175
7.13	Position Sensor Abnormality .....	176
7.14	DC Voltage/Current Sensor Abnormality .....	179
7.15	Thermistor or Related Abnormality (Outdoor Unit) .....	180
7.16	Electrical Box Temperature Rise .....	182
7.17	Radiation Fin Temperature Rise .....	183
7.18	Output Overcurrent Detection .....	185
8.	Check .....	188
8.1	Thermistor Resistance Check .....	188
8.2	Indoor Fan Motor Connector Check .....	189
8.3	Power Supply Waveform Check .....	190
8.4	Electronic Expansion Valve Check .....	191
8.5	Four Way Valve Performance Check .....	192
8.6	Inverter Unit Refrigerant System Check .....	192
8.7	Inverter Analyzer Check .....	193
8.8	Outdoor Fan Motor Check .....	196
8.9	Installation Condition Check .....	197
8.10	Discharge Pressure Check .....	197
8.11	Outdoor Fan System Check .....	198
8.12	Main Circuit Short Check .....	198
8.13	Power Module Check .....	200

# 1. General Problem Symptoms and Check Items

Symptom	Check Item	Measures	Reference Page
The unit does not operate.	Check the power supply.	Check if the rated voltage is supplied.	—
	Check the type of the indoor unit.	Check if the indoor unit type is compatible with the outdoor unit.	—
	Check the outdoor temperature.	Heating/cooling operations are not available when the outdoor temperature is out of the operation limit. Check the reference page for the operation limit.	237
	Diagnose with remote controller indication.	—	123
	Check the remote controller addresses.	Check if address settings for the remote controller and indoor unit are correct.	210
Operation sometimes stops.	Check the power supply.	A power failure of 2 to 10 cycles stops air conditioner operation. (Operation lamp OFF)	—
	Check the outdoor temperature.	Heating/cooling operations are not available when the outdoor temperature is out of the operation limit. Check the reference page for the operation limit.	237
	Diagnose with remote controller indication.	—	123
The unit operates but does not cool, or does not heat.	Check for wiring and piping errors in the connection between the indoor unit and outdoor unit.	—	—
	Check for thermistor detection errors.	Check if the thermistor is mounted securely.	—
	Check for faulty operation of the electronic expansion valve.	Set the unit to cooling operation, and check the temperature of the liquid pipe to see if the electronic expansion valve works.	—
	Diagnose with remote controller indication.	—	123
	Diagnose by service port pressure and operating current.	Check for refrigerant shortage.	—
Large operating noise and vibrations	Check the resistance between the terminals of the power module.	—	200
	Check the power module.	—	—
	Check the installation condition.	Check if the required spaces for installation (specified in the installation manual) are provided.	—



## 2. Troubleshooting with LED

### 2.1 Indoor Unit

**Operation Lamp** Check the interval time between blinks of the OPERATION lamp.

■ **FTXR Series**

**Blink every 2 to 3 seconds**

If the operation mode is different from the operation mode of the indoor unit in another room, the OPERATION lamp may blink and operation may not be performed, or operation may stop while in progress.

COOL, DRY and HEAT operation may not be used at the same time.

**Blink every 0.5 seconds**

This is a notification of an abnormality.

Conduct the diagnostic procedure described in the following pages.

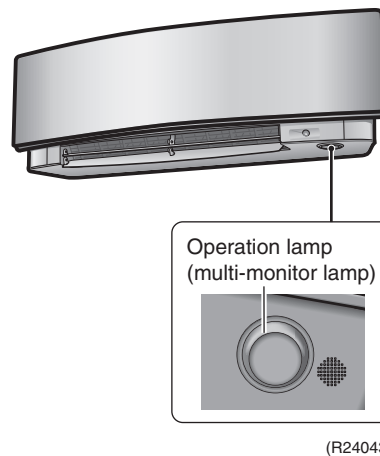

■ **FDMQ, FFQ Series with BRC1E73 Wired Remote Controller**

The operation lamp blinks when any of the following errors is detected.

1. When a protection device of the indoor or outdoor unit is activated, or when the thermistor malfunctions.
2. When a signal transmission error occurs between the indoor and outdoor units.

In either case, conduct the diagnostic procedure described in the following pages.

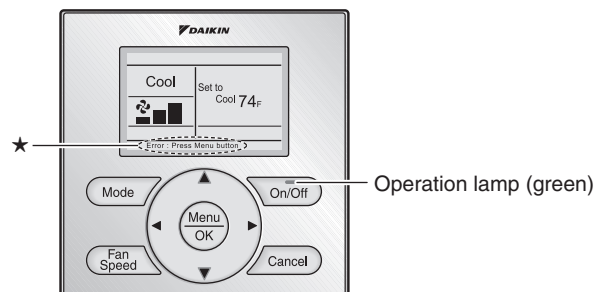

★The error or warning message also blinks on the basic screen.

R4003516

■ **FDMQ Series with BRC082A43 Wireless Remote Controller**

In case of wireless remote controller, a receiver is installed. When the error occurs, the operation lamp on the receiver blinks.

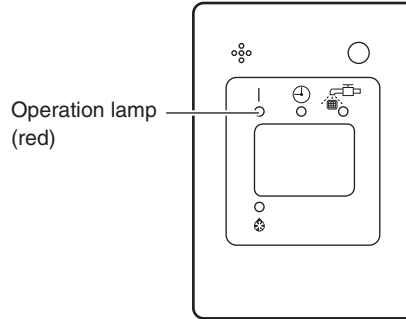

R4003517

■ **FFQ Series with BRC082A41W, BRC082A42W(S) Wireless Remote Controller**

In case of wireless remote controller, a transmitter board (A2P) and a receiver (A3P) are installed on indoor unit. When the error occurs, the operation lamp on the receiver (A3P) blinks.

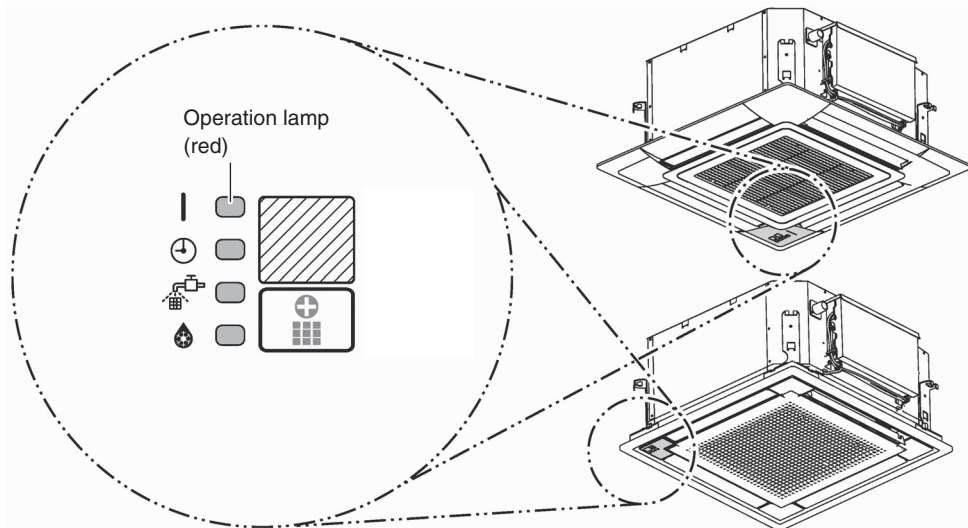

R4003518

 **Caution**

When operation stops suddenly and the operation lamp blinks, it could be operation mode conflict. For FFQ models, even if the operation mode conflict occurs, the operation lamp does not blink.

1. Check if the operation modes are all the same for the indoor units connected to multi system outdoor unit.
2. If not, set all the indoor units to the same operation mode and confirm that the operation lamp is not blinking.
3. Moreover, when the operation mode is automatic, set all the indoor unit operation mode as cooling or heating and check again if the operation lamp is normal.  
If the lamp stops blinking after the above steps, there is no malfunction.

\*Operation stops and operation lamp blinks only for the indoor unit that has a different operation mode set later. The first set operation mode has priority.

**Service Monitor**

The indoor unit has a green LED (LED A, HAP) on the control PCB. When the microcomputer works in order, the LED blinks. (Refer to page 23, 25, 27 for the location of LED.)

## 2.2 Outdoor Unit

The outdoor unit has one green LED (LED A) on the PCB. When the microcomputer works in order, the LED A blinks. However, the LED A turns OFF while the standby electricity saving function is activated and the power supply is OFF.

Refer to page 32, 34 for the location of LED A.

# 3. Service Diagnosis

## 3.1 ARC466 Series

### 3.1.1 Method 1

1. When **Timer Cancel** button is held down for 5 seconds, **00** is displayed on the temperature display screen.
2. Press **Timer Cancel** button repeatedly until a long beep sounds.

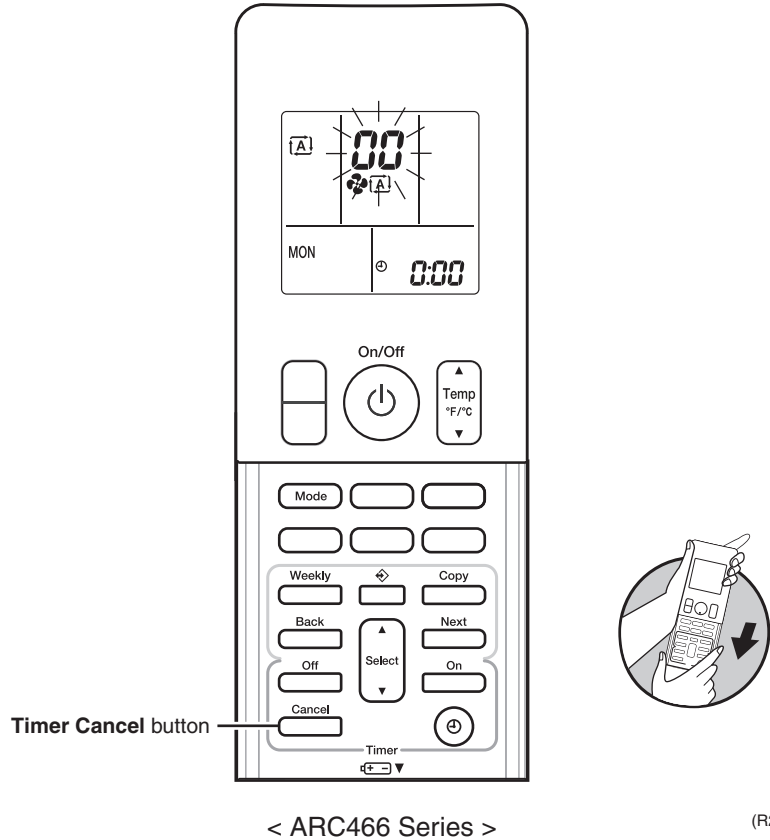

**i** Note(s)

1. A short beep or two consecutive beeps indicate non-corresponding codes.
2. To return to the normal mode, hold **Timer Cancel** button down for 5 seconds. When the remote controller is left untouched for 60 seconds, it also returns to the normal mode.
3. Not all the error codes are displayed. When you cannot find the error code, try method 2. Refer to page 115.

■ The code indication changes in the sequence shown below.

**ARC466A36**

No.	Code	No.	Code	No.	Code	No.	Code	No.	Code
1	<b>00</b>	10	<b>E6</b>	19	<b>C9</b>	28	<b>UH</b>	37	<b>E3</b>
2	<b>A5</b>	11	<b>H6</b>	20	<b>C4</b>	29	<b>P4</b>	38	<b>H3</b>
3	<b>E7</b>	12	<b>H0</b>	21	<b>C5</b>	30	<b>H7</b>		
4	<b>F3</b>	13	<b>A6</b>	22	<b>J3</b>	31	<b>U2</b>		
5	<b>F6</b>	14	<b>U0</b>	23	<b>J6</b>	32	<b>EA</b>		
6	<b>L3</b>	15	<b>C7</b>	24	<b>E5</b>	33	<b>AH</b>		
7	<b>L4</b>	16	<b>A3</b>	25	<b>A1</b>	34	<b>FA</b>		
8	<b>L5</b>	17	<b>H8</b>	26	<b>E1</b>	35	<b>H1</b>		
9	<b>U4</b>	18	<b>H9</b>	27	<b>UA</b>	36	<b>P9</b>		

### 3.1.2 Method 2

1. Press the center of **Temp** button and **Mode** button at the same time.

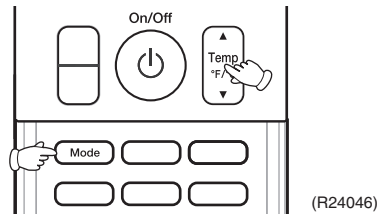

**SC** is displayed on the LCD.

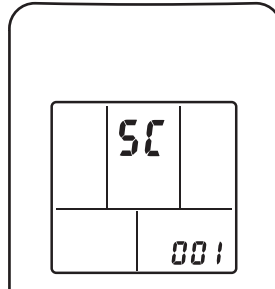

2. Select **SC** (service check) with **Temp ▲** or **Temp ▼** button.
3. Press **Mode** button to enter the service check mode.

R6000375

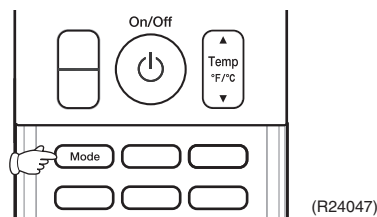

The left-side number blinks.

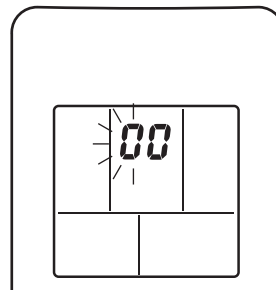

4. Press **Temp ▲** or **Temp ▼** button and change the number until you hear the two consecutive beeps or the long beep.

R6000373

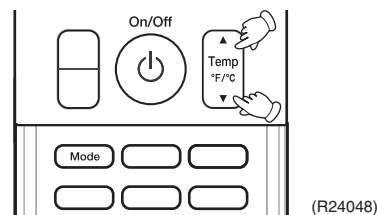

5. Diagnose by the sound.
  - Beep: The left-side number does not correspond with the error code.
  - Two consecutive beeps: The left-side number corresponds with the error code but the right-side number does not.

- Long beep: Both the left-side and right-side numbers correspond with the error code. The numbers indicated when you hear the long beep are the error code. Refer to page 123.

6. Press **Mode** button.

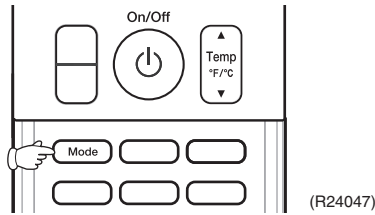

The right-side number blinks.

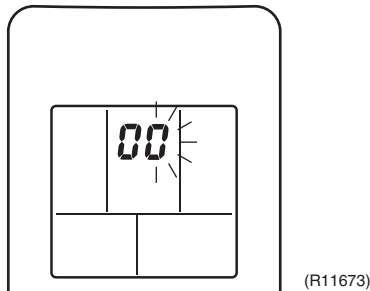

7. Press **Temp ▲** or **Temp ▼** button and change the number until you hear the long beep.

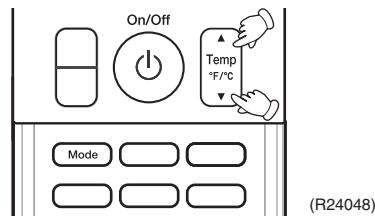

8. Diagnose by the sound.

- Beep: The left-side number does not correspond with the error code.
- Two consecutive beeps: The left-side number corresponds with the error code but the right-side number does not.
- Long beep: Both the left-side and right-side numbers correspond with the error code.

9. Determine the error code.

The numbers indicated when you hear the long beep are the error code. Refer to page 123.

10. Press **Mode** button for 5 seconds to exit from the service check mode.

When the remote controller is left untouched for 60 seconds, it returns to the normal mode also.

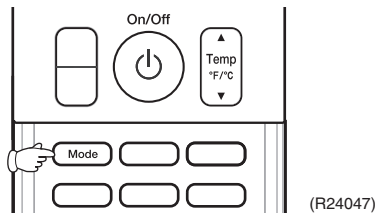

## 3.2 BRC1E73

### Relations Between Modes

On power-up, the message “**Checking the connection. Please standby.**” will be displayed on the remote controller screen temporarily and then the basic screen will be displayed. To access a mode from the basic screen, refer to the figure below.

When any of the operation buttons is pressed, the backlight will come on and remain lit for about 30 seconds. Be sure to press a button while the backlight is on.

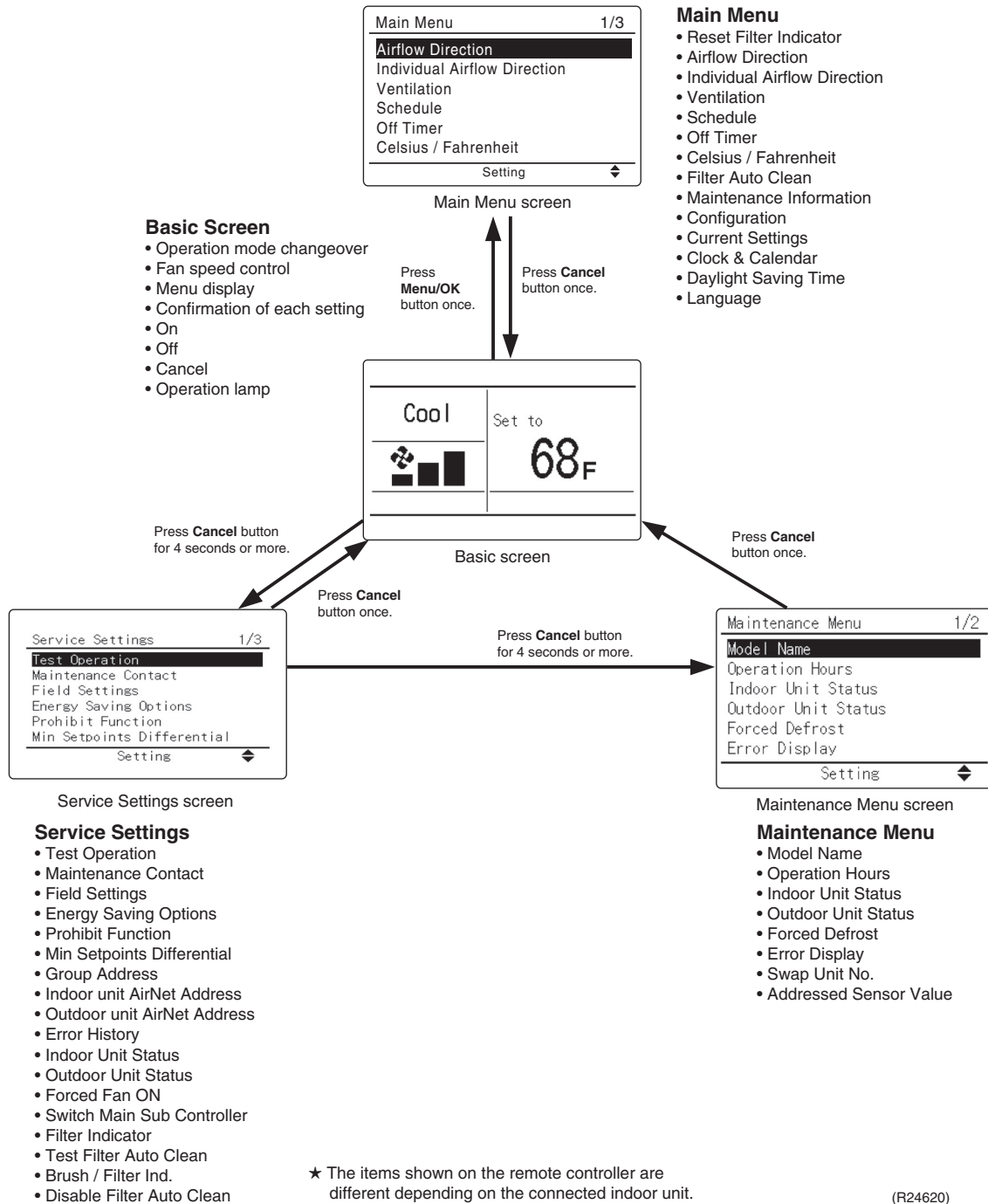

**Service Diagnosis**

The following message is displayed on the screen when an error (or a warning) occurs during operation.  
Check the error code and take the corrective action specified for the particular model.

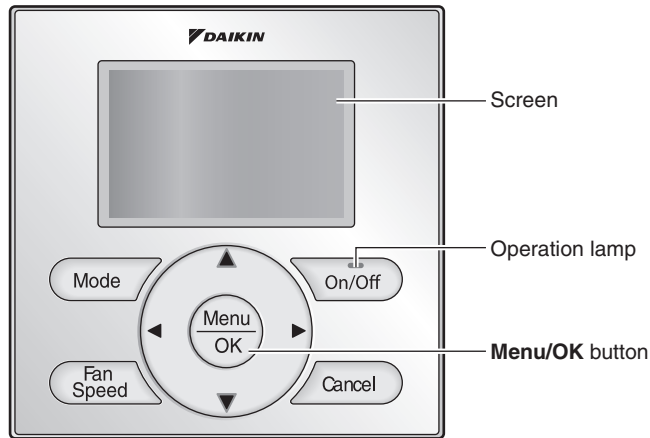

(R18817)

**Operation**

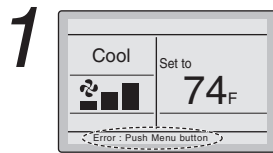

- If an error occurs, either one of the following items will flash in the basic screen.

**Error: Push Menu button**

- \* The Operation lamp will flash.
- \* For Simple display, the message is not displayed, and only the Operation lamp flashes.

**Warning: Push Menu button**

- \* The Operation lamp will not flash.
- \* For Simple display, the message is not displayed, and the Operation lamp does not flash, either.

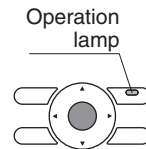

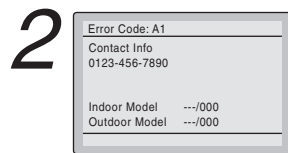

- Press **Menu/OK** button.





- The error code will flash and the service contact and model name or code may be displayed.
- Notify your Daikin dealer of the Error code and model name or code.

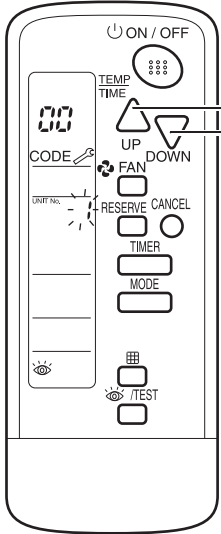

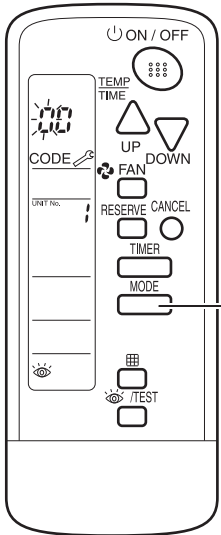

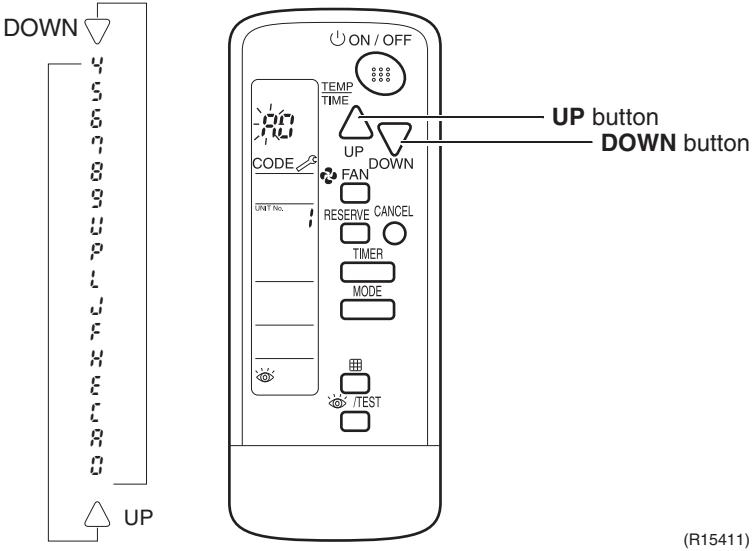
Step	Action								
<p><b>2</b></p>	<p>Press <b>UP</b> or <b>DOWN</b> button and change the UNIT No. until the indoor unit starts to beep.</p> <div data-bbox="751 310 1279 846" style="text-align: center;">  <p><b>UP</b> button <b>DOWN</b> button</p> </div> <p style="text-align: right;">(R15408)</p> <table border="1" data-bbox="641 923 1398 1166" style="width: 100%; border-collapse: collapse;"> <thead> <tr> <th data-bbox="641 923 1019 959">If you hear...</th> <th data-bbox="1019 923 1398 959">Then...</th> </tr> </thead> <tbody> <tr> <td data-bbox="641 959 1019 995">3 short beeps</td> <td data-bbox="1019 959 1398 995">Follow all steps below.</td> </tr> <tr> <td data-bbox="641 995 1019 1129">1 short beep</td> <td data-bbox="1019 995 1398 1129">Follow steps 3 and 4. Continue the operation in step 4 until you hear a long beep. This long beep indicates that the error code is confirmed.</td> </tr> <tr> <td data-bbox="641 1129 1019 1166">1 long beep</td> <td data-bbox="1019 1129 1398 1166">There is no abnormality.</td> </tr> </tbody> </table>	If you hear...	Then...	3 short beeps	Follow all steps below.	1 short beep	Follow steps 3 and 4. Continue the operation in step 4 until you hear a long beep. This long beep indicates that the error code is confirmed.	1 long beep	There is no abnormality.
If you hear...	Then...								
3 short beeps	Follow all steps below.								
1 short beep	Follow steps 3 and 4. Continue the operation in step 4 until you hear a long beep. This long beep indicates that the error code is confirmed.								
1 long beep	There is no abnormality.								
<p><b>3</b></p>	<p>Press <b>OPERATION MODE SELECTOR</b> button. The left  (upper digit) indication of the error code blinks.</p> <div data-bbox="743 1268 1295 1804" style="text-align: center;">  <p><b>OPERATION MODE SELECTOR</b> button</p> </div> <p style="text-align: right;">(R24051)</p>								

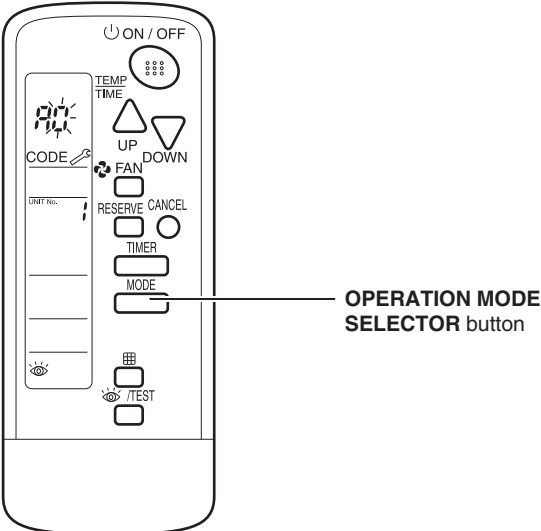
Step	Action								
<p><b>4</b></p>	<p>Press <b>UP</b> or <b>DOWN</b> button to change the error code upper digit until the indoor unit beeps.</p>  <p>(R15411)</p> <table border="1" data-bbox="641 932 1398 1074"> <thead> <tr> <th>If you hear...</th> <th>Then...</th> </tr> </thead> <tbody> <tr> <td>2 short beeps</td> <td>The upper digit matches.</td> </tr> <tr> <td>1 short beep</td> <td>No digits match.</td> </tr> <tr> <td>1 long beep</td> <td>Both upper and lower digits match.</td> </tr> </tbody> </table>	If you hear...	Then...	2 short beeps	The upper digit matches.	1 short beep	No digits match.	1 long beep	Both upper and lower digits match.
If you hear...	Then...								
2 short beeps	The upper digit matches.								
1 short beep	No digits match.								
1 long beep	Both upper and lower digits match.								
<p><b>5</b></p>	<p>Press <b>OPERATION MODE SELECTOR</b> button. The right  (lower digit) indication of the error code blinks.</p>  <p>(R24052)</p>								

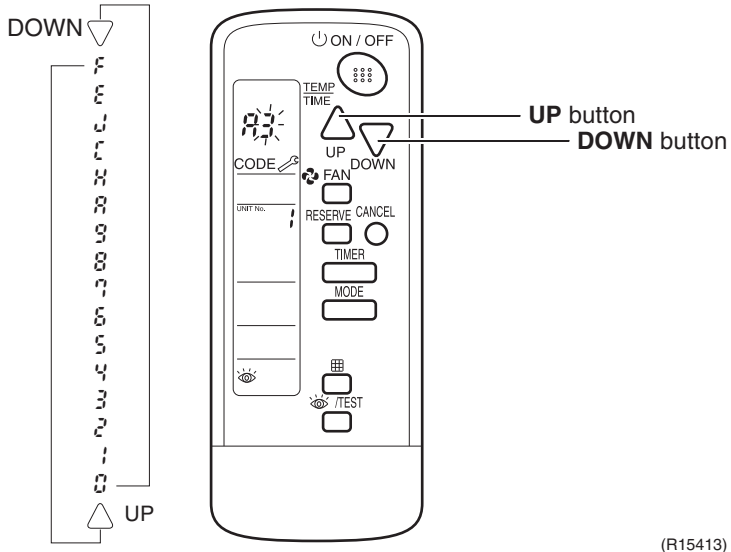
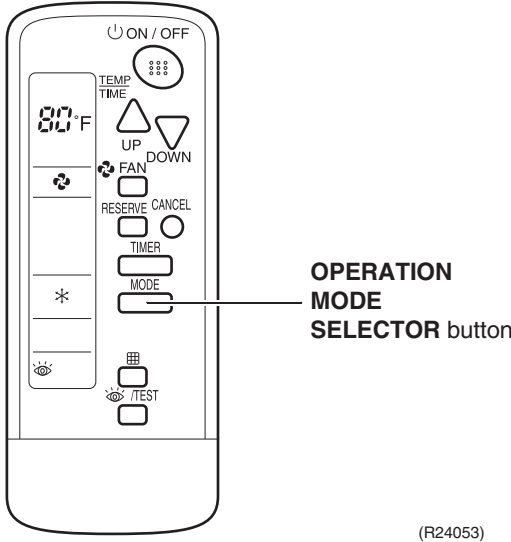
Step	Action						
<p><b>6</b></p>	<p>Press <b>UP</b> or <b>DOWN</b> button and change the error code lower digit until the indoor unit generates long beep.</p>  <p>(R15413)</p> <table border="1" data-bbox="641 932 1398 1042"> <thead> <tr> <th>If you hear...</th> <th>Then...</th> </tr> </thead> <tbody> <tr> <td>2 short beeps</td> <td>No digits match.</td> </tr> <tr> <td>1 long beep</td> <td>Both upper and lower digits match.</td> </tr> </tbody> </table>	If you hear...	Then...	2 short beeps	No digits match.	1 long beep	Both upper and lower digits match.
If you hear...	Then...						
2 short beeps	No digits match.						
1 long beep	Both upper and lower digits match.						
<p><b>7</b></p>	<p>Press <b>OPERATION MODE SELECTOR</b> button to return to the normal mode. If you do not press any button for 1 minute, the remote controller automatically returns to the normal mode.</p>  <p>(R24053)</p>						

## 4. Error Codes and Description

	Error Codes	Description	Reference Page		
			FTXR	FDMQ	FFQ
System	<b>00</b>	Normal	—	—	—
	<b>U0★</b>	Refrigerant shortage	—	—	—
	<b>U2</b>	Low-voltage detection or over-voltage detection	132	149	149
	<b>U4</b>	Signal transmission error (between indoor unit and outdoor unit)	134	151	151
	<b>U5</b>	Signal transmission error (between indoor unit and remote controller)	—	153	153
	<b>U8</b>	Signal transmission error (between MAIN/SUB remote controller)	—	154	154
	<b>UA</b>	Unspecified voltage (between indoor unit and outdoor unit)	136	155	155
Indoor Unit	<b>A1</b>	Indoor unit PCB abnormality	124	137	137
	<b>A3</b>	Drain level control system abnormality	—	138	138
	<b>A5</b>	Freeze-up protection control/heating peak-cut control	126	—	—
	<b>A6</b>	Fan motor (DC motor) or related abnormality	127	139	141
	<b>A8</b>	Indoor fan PCB abnormality	—	144	—
	<b>AF</b>	Humidifier or related abnormality	—	145	145
	<b>C4</b>	Indoor heat exchanger thermistor or related abnormality	130	146	146
	<b>C5</b>		—	146	146
	<b>C7</b>	Front panel open/close fault	131	—	—
	<b>C9</b>	Room temperature thermistor or related abnormality	130	146	146
	<b>CE</b>	Presence sensor or floor sensor abnormality	—	—	147
	<b>CJ</b>	Remote controller thermistor abnormality	—	148	148
Outdoor Unit	<b>E1</b>	Outdoor unit PCB abnormality	156		
	<b>E3★</b>	Actuation of high pressure switch	157		
	<b>E5★</b>	OL activation (compressor overload) or HPS activation (high pressure switch)	159		
		OL activation (compressor overload)	162		
	<b>E6★</b>	Compressor lock	165		
	<b>E7★</b>	DC fan lock	166		
	<b>E8</b>	Input overcurrent detection	167		
	<b>EA</b>	Four way valve abnormality	169		
	<b>F3</b>	Discharge pipe temperature control	171		
	<b>F6</b>	High pressure control in cooling	172		
	<b>F8</b>	System shutdown due to temperature abnormality in compressor	174		
	<b>H0</b>	Compressor system sensor abnormality	175		
	<b>H6</b>	Position sensor abnormality	176		
	<b>H8</b>	DC voltage/current sensor abnormality	179		
	<b>H9</b>	Outdoor temperature thermistor or related abnormality	180		
	<b>J3★</b>	Discharge pipe thermistor or related abnormality	180		
	<b>J6</b>	Outdoor heat exchanger thermistor or related abnormality	180		
	<b>L3★</b>	Electrical box temperature rise	182		
	<b>L4</b>	Radiation fin temperature rise	183		
	<b>L5★</b>	Output overcurrent detection	185		
<b>P4</b>	Radiation fin thermistor or related abnormality	180			

★: Displayed only when system-down occurs for method 1.

## 5. Troubleshooting for FTXR Series

### 5.1 Indoor Unit PCB Abnormality

---

<b>Error Code</b>	<b>A1</b>
<b>Method of Error Detection</b>	The system checks if the circuit works properly within the microcomputer of the indoor unit.
<b>Error Decision Conditions</b>	The system cannot set the internal settings.
<b>Supposed Causes</b>	<ul style="list-style-type: none"><li>■ Wrong models interconnected</li><li>■ Defective indoor unit PCB</li><li>■ Disconnection of connector</li><li>■ Reduction of power supply voltage</li></ul>

---

Troubleshooting

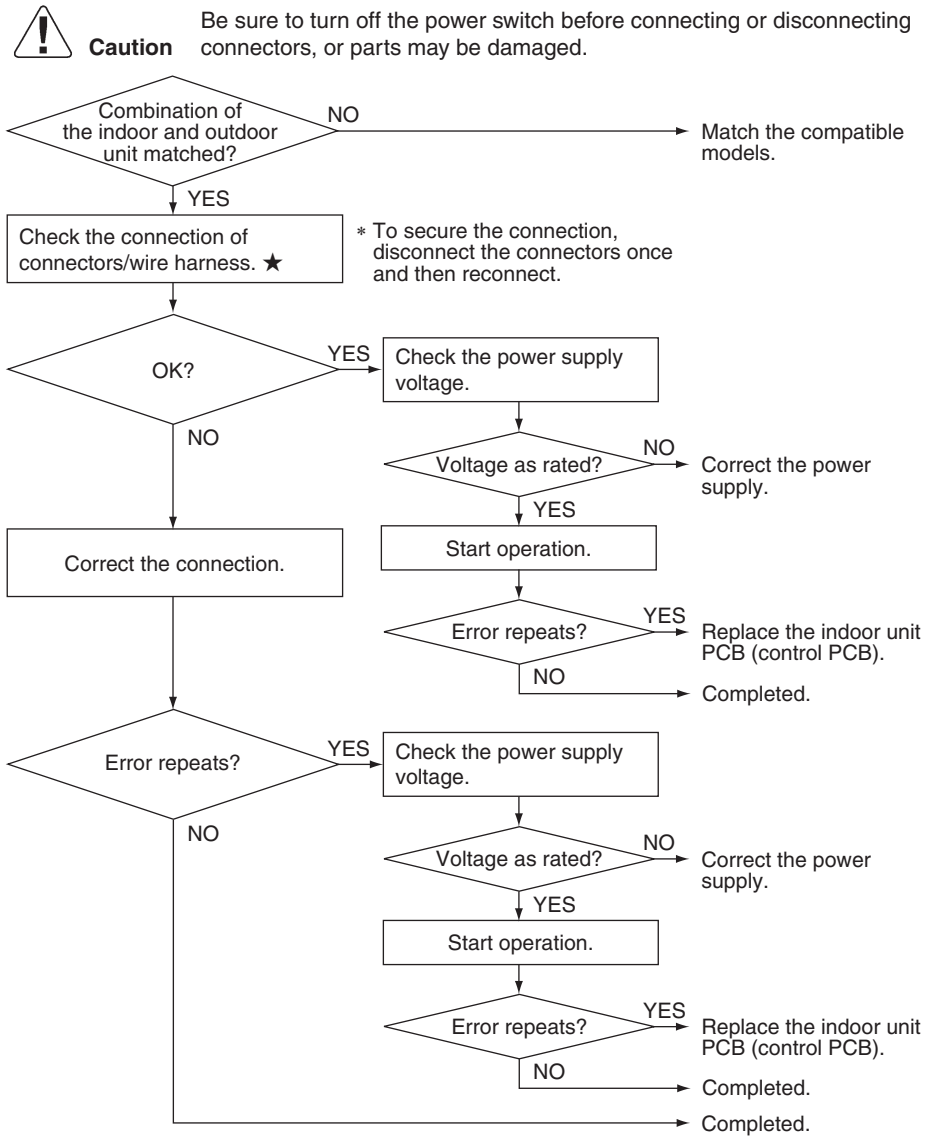

R6000615



**Note**

★ Wire harness (Connector): Terminal strip ~ Control PCB (H1, H2, H3)

## 5.2 Freeze-up Protection Control/Heating Peak-cut Control

<b>Error Code</b>	<b>A5</b>
<b>Method of Error Detection</b>	<ul style="list-style-type: none"> <li>■ Freeze-up protection control During cooling operation, the freeze-up protection control (operation halt) is activated according to the temperature detected by the indoor heat exchanger thermistor.</li> <li>■ Heating peak-cut control During heating operation, the temperature detected by the indoor heat exchanger thermistor is used for the heating peak-cut control (operation halt, outdoor fan stop, etc.)</li> </ul>
<b>Error Decision Conditions</b>	<ul style="list-style-type: none"> <li>■ Freeze-up protection control During cooling operation, the indoor heat exchanger temperature is below 0°C (32°F).</li> <li>■ Heating peak-cut control During heating operation, the indoor heat exchanger temperature is above 62.5°C (144.5°F).</li> </ul>
<b>Supposed Causes</b>	<ul style="list-style-type: none"> <li>■ Short-circuited air</li> <li>■ Clogged air filter of the indoor unit</li> <li>■ Dust accumulation on the indoor heat exchanger</li> <li>■ Defective indoor heat exchanger thermistor</li> <li>■ Defective indoor unit PCB</li> </ul>

### Troubleshooting

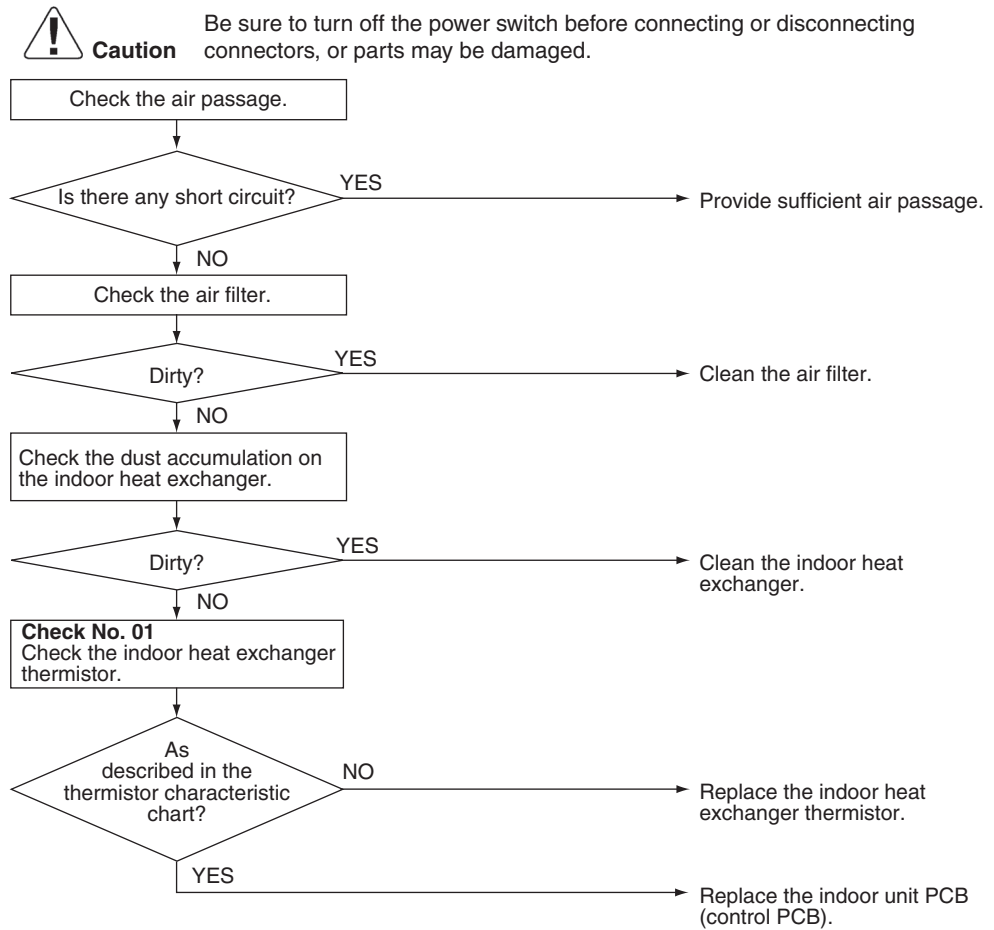

(R21064)



Reference

**Check No.01** Refer to P.188



## 5.3 Indoor Fan Motor (DC Motor) or Related Abnormality

---

**Error Code****A6**

---

**Method of Error Detection**

The rotation speed detected by the Hall IC during indoor fan motor operation determines abnormal fan motor operation.

---

**Error Decision Conditions**

The detected rotation speed does not reach the demanded rotation speed of the target tap, and is less than 50% of the maximum fan motor rotation speed.

---

**Supposed Causes**

- Remarkable decrease in power supply voltage
- Layer short inside the fan motor winding
- Breaking of wire inside the fan motor
- Breaking of the fan motor lead wires
- Defective capacitor of the fan motor
- Defective indoor unit PCB

Troubleshooting

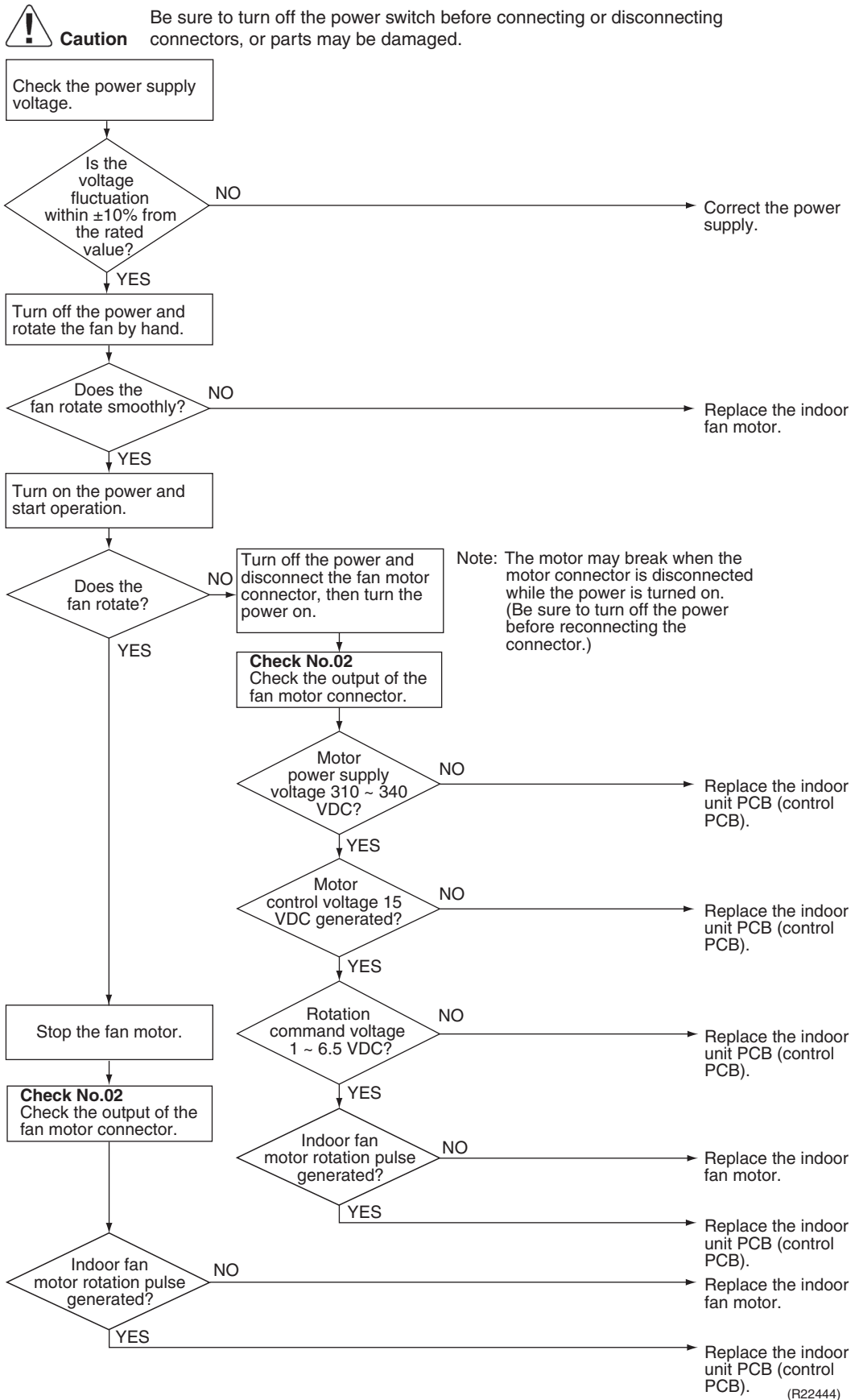

**Note**

The rotation pulse is the feedback signal from the indoor fan motor.

**Reference**

**Check No.02** Refer to P.189

## 5.4 Thermistor or Related Abnormality

<b>Error Code</b>	<b>C4, C9</b>
<b>Method of Error Detection</b>	The temperatures detected by the thermistors determine thermistor errors.
<b>Error Decision Conditions</b>	The communication error of thermistor(s) or malfunction of thermistor(s).
<b>Supposed Causes</b>	<ul style="list-style-type: none"> <li>■ Disconnection of connector</li> <li>■ Defective thermistor(s)</li> <li>■ Defective indoor unit PCB</li> </ul>

**Troubleshooting**

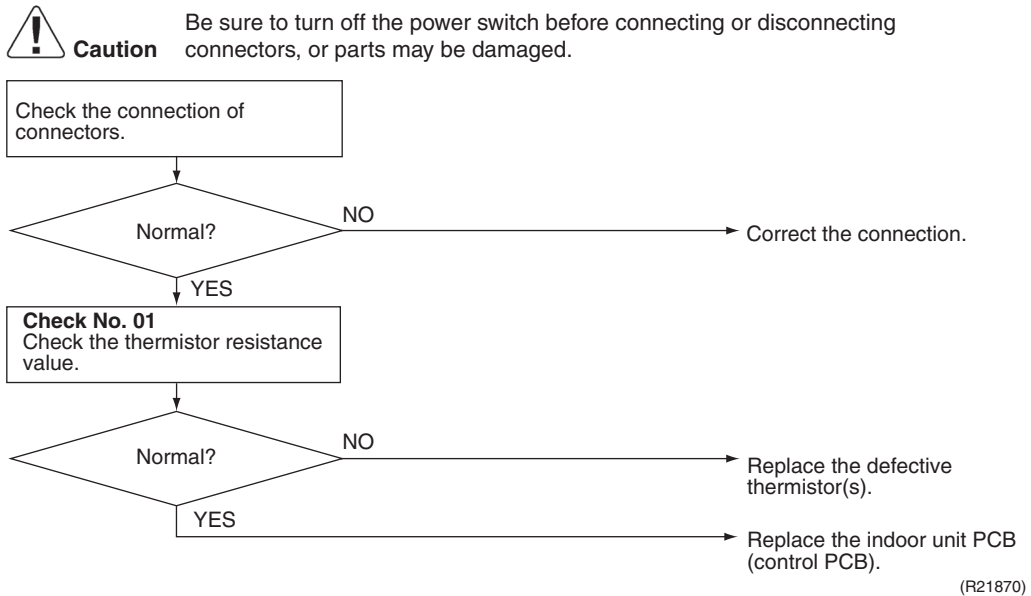

**C4** : Indoor heat exchanger thermistor  
**C9** : Room temperature thermistor



**Reference**

**Check No.01** Refer to P.188

## 5.5 Front Panel Open/Close Fault

Error Code

**C7**

Error Decision Conditions

If the error repeats, the system is shut down.

Supposed Causes

- Defective reduction motor
- Malfunction or deterioration of the front panel mechanism
- Defective limit switch

Troubleshooting

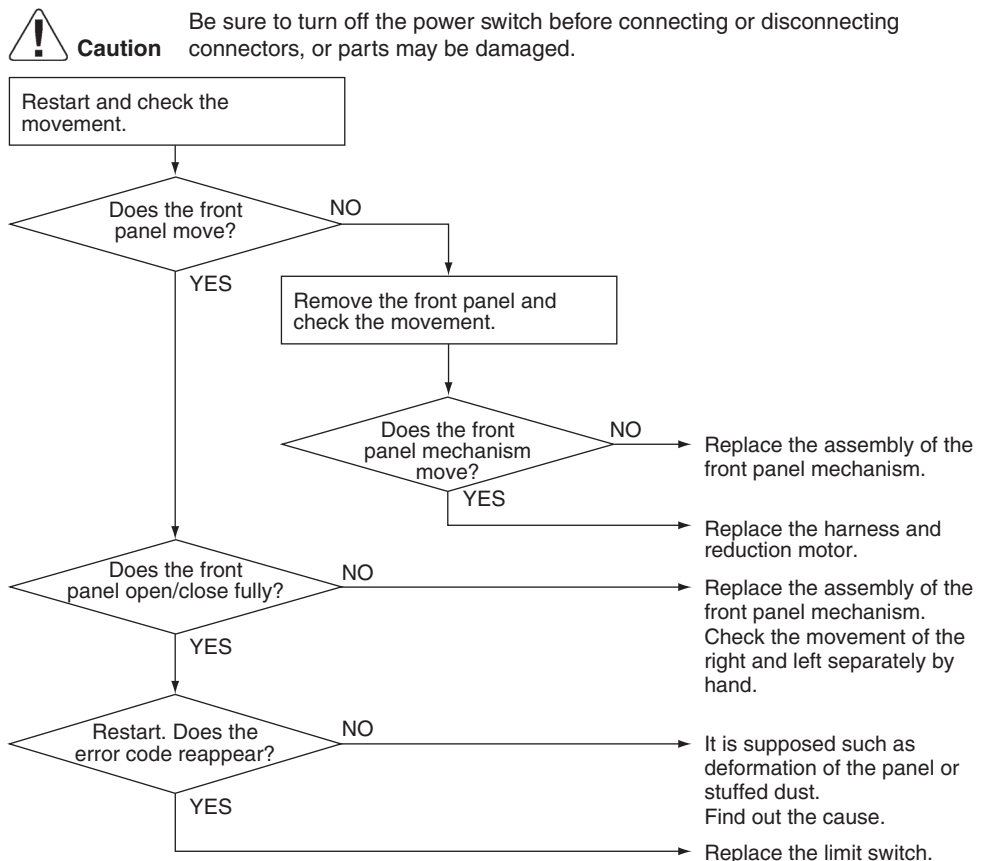

(R17249)



**Note**

You cannot operate the unit by the remote controller when the front panel mechanism breaks down.

<To the dealers: temporary measure before repair>

1. Turn off the power.
2. Remove the front panel.
3. Turn on the power.

(Wait until the initialization finishes.)

Operate the unit by the indoor unit **ON/OFF** switch.

## 5.6 Low-voltage Detection or Over-voltage Detection

<b>Error Code</b>	<b>U2</b>
<b>Method of Error Detection</b>	<p><b>Low-voltage detection:</b> An abnormal voltage drop is detected by the DC voltage detection circuit.</p> <p><b>Over-voltage detection:</b> An abnormal voltage rise is detected by the over-voltage detection circuit.</p>
<b>Error Decision Conditions</b>	<p><b>Low-voltage detection:</b></p> <ul style="list-style-type: none"> <li>■ The voltage detected by the DC voltage detection circuit is below 180 ~ 196 V (depending on the model).</li> <li>■ The compressor stops if the error occurs, and restarts automatically after 3-minute standby.</li> </ul> <p><b>Over-voltage detection:</b></p> <ul style="list-style-type: none"> <li>■ An over-voltage signal is fed from the over-voltage detection circuit to the microcomputer (over 458 ~ 500 V, depending on the model).</li> <li>■ The compressor stops if the error occurs, and restarts automatically after 3-minute standby.</li> </ul>
<b>Supposed Causes</b>	<ul style="list-style-type: none"> <li>■ Power supply voltage out of specification</li> <li>■ Defective DC voltage detection circuit</li> <li>■ Defective over-voltage detection circuit</li> <li>■ Defective PAM control part</li> <li>■ Disconnection of compressor harness</li> <li>■ Short circuit inside the fan motor winding</li> <li>■ Noise</li> <li>■ Momentary drop of voltage</li> <li>■ Momentary power failure</li> <li>■ Defective outdoor unit PCB</li> </ul>

Troubleshooting

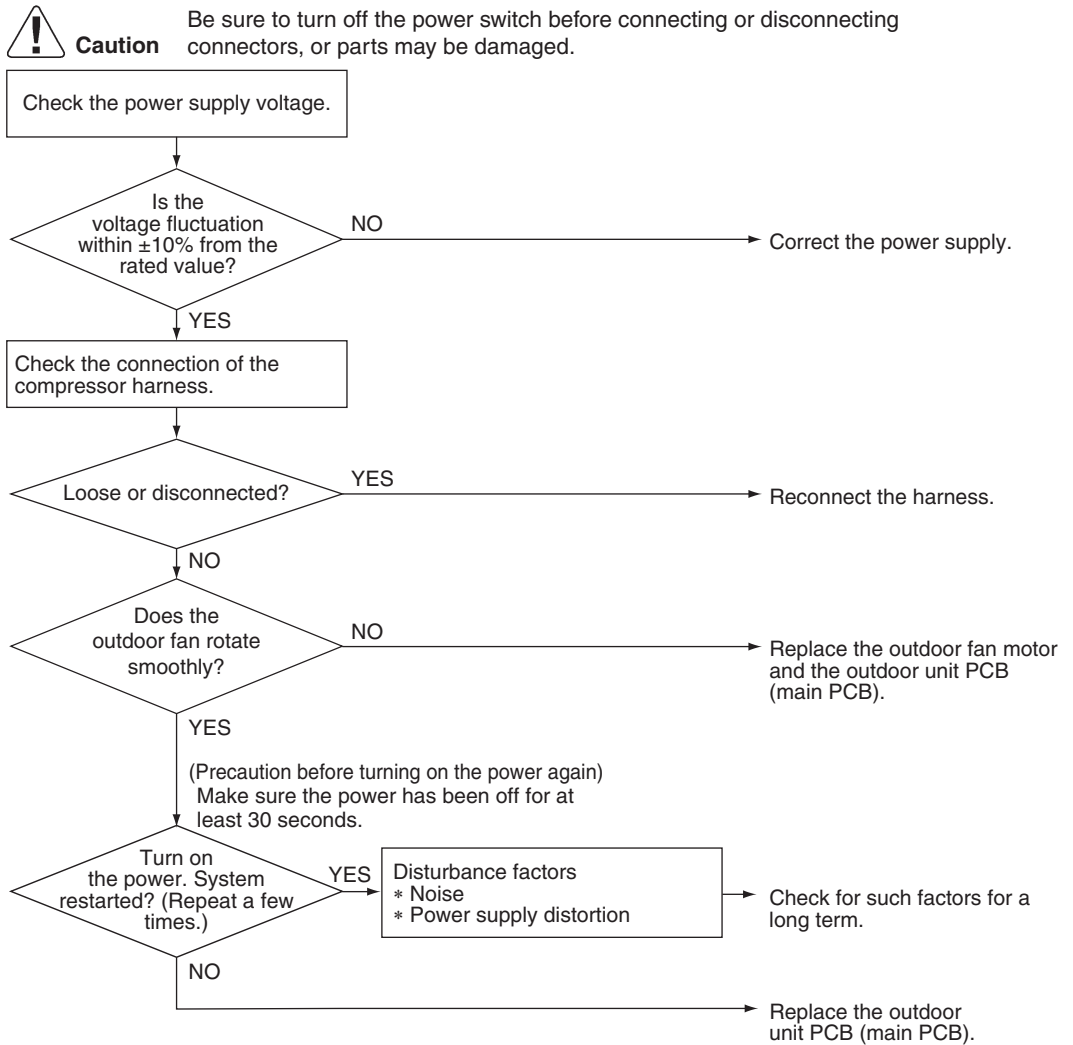

(R22445)

## 5.7 Signal Transmission Error (Between Indoor Unit and Outdoor Unit)

<b>Error Code</b>	<b>U4</b>
<b>Method of Error Detection</b>	The signal transmission data received from the outdoor unit is checked whether it is normal.
<b>Error Decision Conditions</b>	The data sent from the outdoor unit cannot be received normally, or the content of the data is abnormal.
<b>Supposed Causes</b>	<ul style="list-style-type: none"> <li>■ Power supply voltage out of specification</li> <li>■ Reduction of power supply voltage</li> <li>■ Wiring error</li> <li>■ Breaking of the connection wires between the indoor and outdoor units (wire No. 3)</li> <li>■ Defective outdoor unit PCB</li> <li>■ Short circuit inside the fan motor winding</li> <li>■ Defective indoor unit PCB</li> <li>■ Disturbed power supply waveform</li> </ul>



Troubleshooting



**Caution** Be sure to turn off the power switch before connecting or disconnecting connectors, or parts may be damaged.

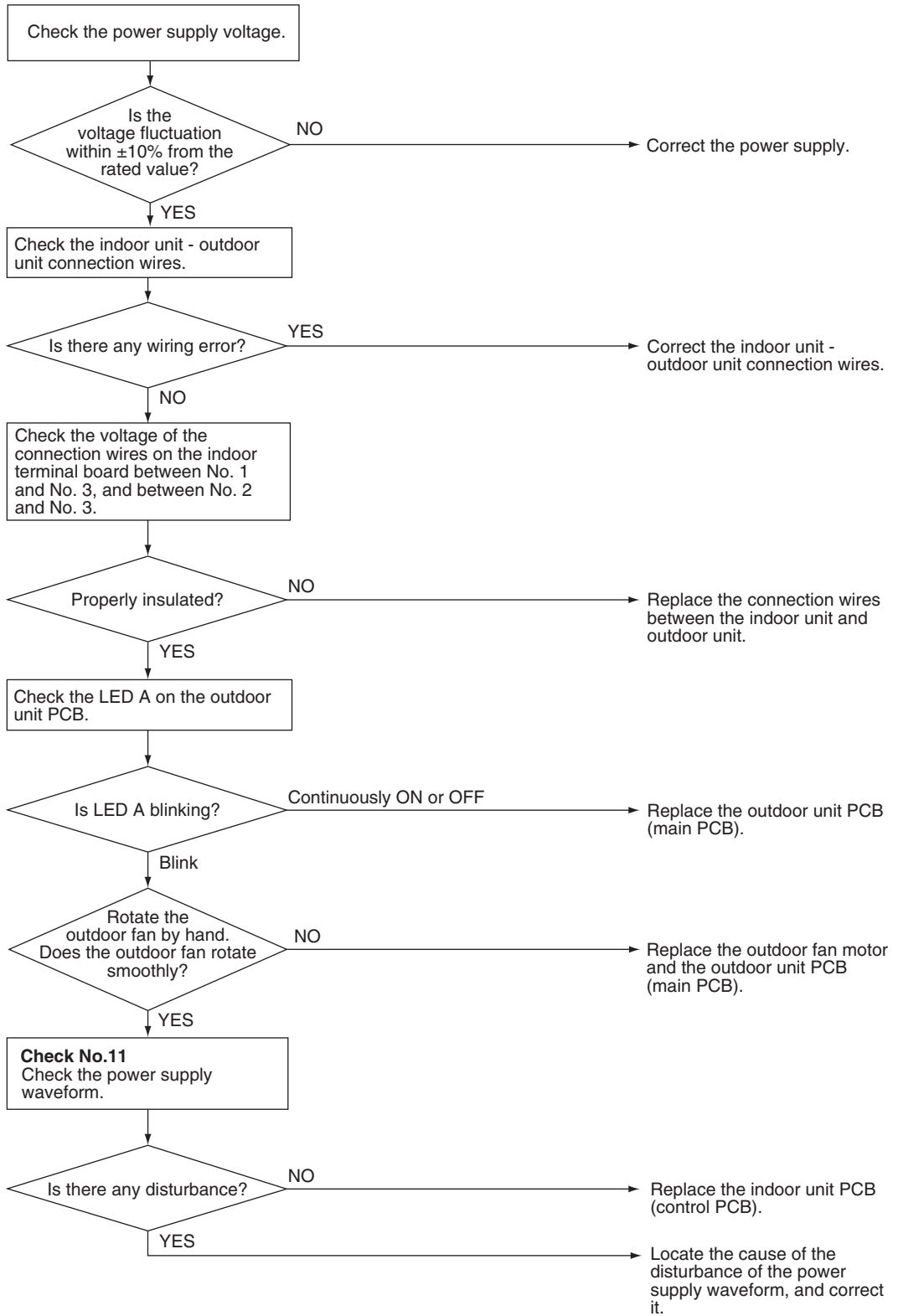

(R21193)



Reference

**Check No.11** Refer to P.190

## 5.8 Unspecified Voltage (Between Indoor Unit and Outdoor Unit)

**Error Code**

**UA**

**Method of Error Detection**

The supply power is detected for its requirements (pair type is different from multi type) by the indoor/outdoor transmission signal.

**Error Decision Conditions**

The pair type and multi type are interconnected.

**Supposed Causes**

- Wrong models interconnected
- Wrong wiring of connecting wires
- Wrong indoor unit PCB or outdoor unit PCB mounted
- Defective indoor unit PCB
- Defective outdoor unit PCB

**Troubleshooting**



**Caution**

Be sure to turn off the power switch before connecting or disconnecting connectors, or parts may be damaged.

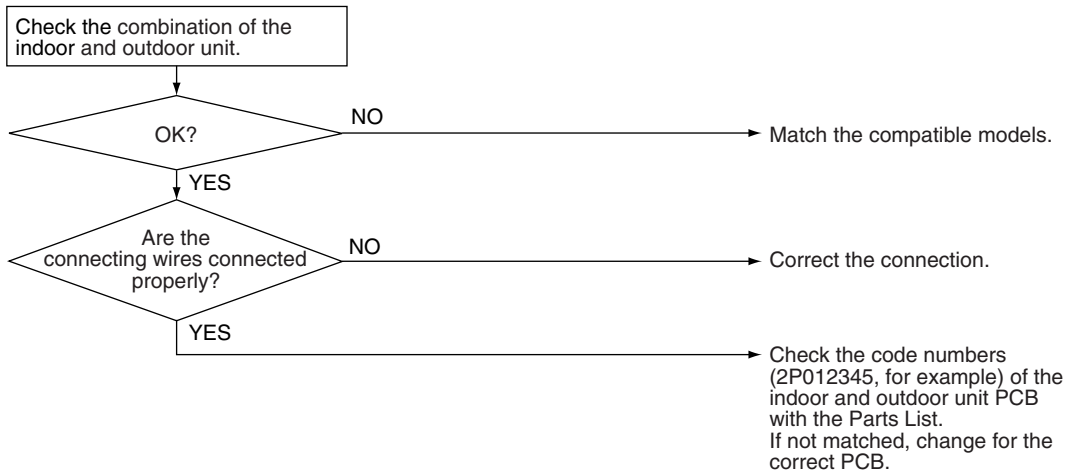

(R20435)

## 6. Troubleshooting for FDMQ, FFQ Series

### 6.1 Indoor Unit PCB Abnormality

Error Code

**A1**

Method of Error  
Detection

The system checks the data from EEPROM.

Error Decision  
Conditions

When the data from the EEPROM is not received correctly

EEPROM (Electrically Erasable Programmable Read Only Memory): A memory chip that holds its content without power. It can be erased, either within the computer or externally and usually requires more voltage for erasure than the common +5 volts used in logic circuits. It functions like non-volatile RAM, but writing to EEPROM is slower than writing to RAM.

Supposed  
Causes

- Defective indoor unit PCB
- External factor (noise etc.)

Troubleshooting



**Caution**

Be sure to turn off the power switch before connecting or disconnecting connectors, or parts may be damaged.

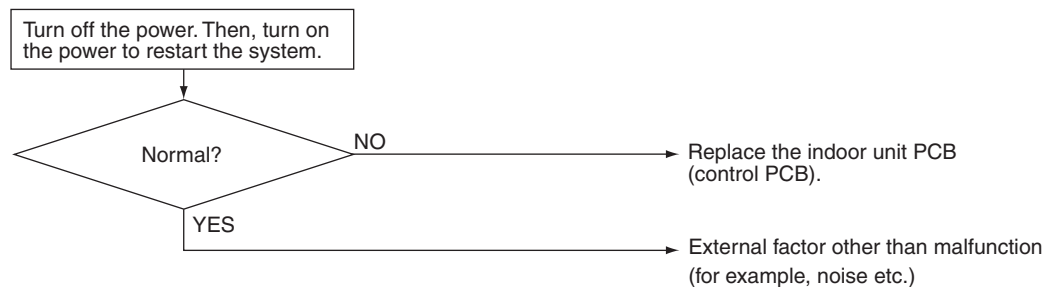

(R22247)

## 6.2 Drain Level Control System Abnormality

<b>Error Code</b>	<b>A3</b>
<b>Method of Error Detection</b>	The float switch detects error.
<b>Error Decision Conditions</b>	When the water level reaches its upper limit and when the float switch turns OFF
<b>Supposed Causes</b>	<ul style="list-style-type: none"> <li>■ Defective drain pump</li> <li>■ Improper drain piping work</li> <li>■ Clogged drain piping</li> <li>■ Defective float switch</li> <li>■ Defective indoor unit PCB</li> <li>■ Defective short circuit connector X15A, X25A on indoor unit PCB</li> </ul>

### Troubleshooting

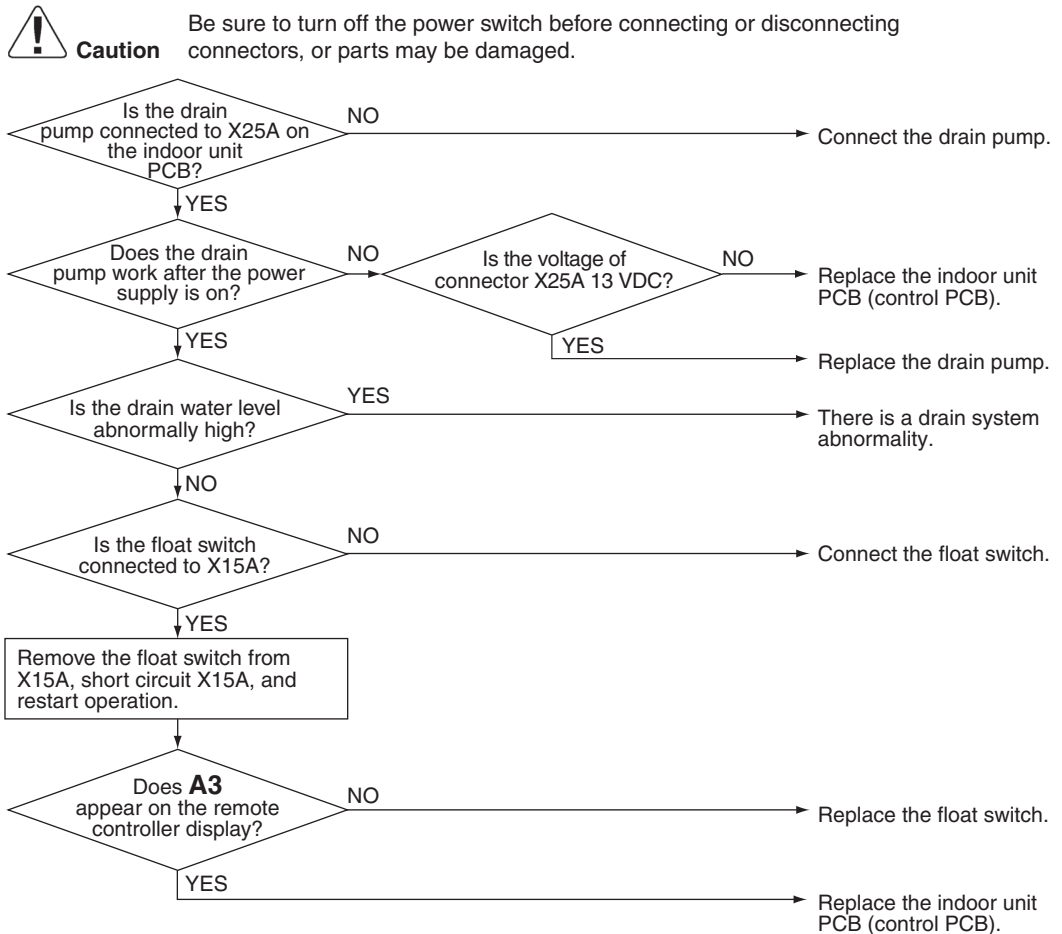

(R25079)

## 6.3 Indoor Fan Motor or Related Abnormality

### 6.3.1 Indoor Fan Motor (DC Motor) or Related Abnormality

**Applicable Models** FDMQ09/12/15/18/24VVJU9

**Error Code** **A6**

**Method of Error Detection**

- Detection from the current flow on the fan PCB
- Detection from the rotation speed of the fan motor in operation

**Error Decision Conditions** The rotation speed is less than a certain level for 6 seconds.

**Supposed Causes**

- Clogged foreign matter
- Disconnection of fan motor connectors
- Disconnection of the connector between the indoor unit PCB and the fan PCB
- Defective fan PCB
- Defective fan motor
- No fuse continuity

#### Trouble Shooting



**Caution**

Be sure to turn off the power switch before connecting or disconnecting connectors, or parts may be damaged.

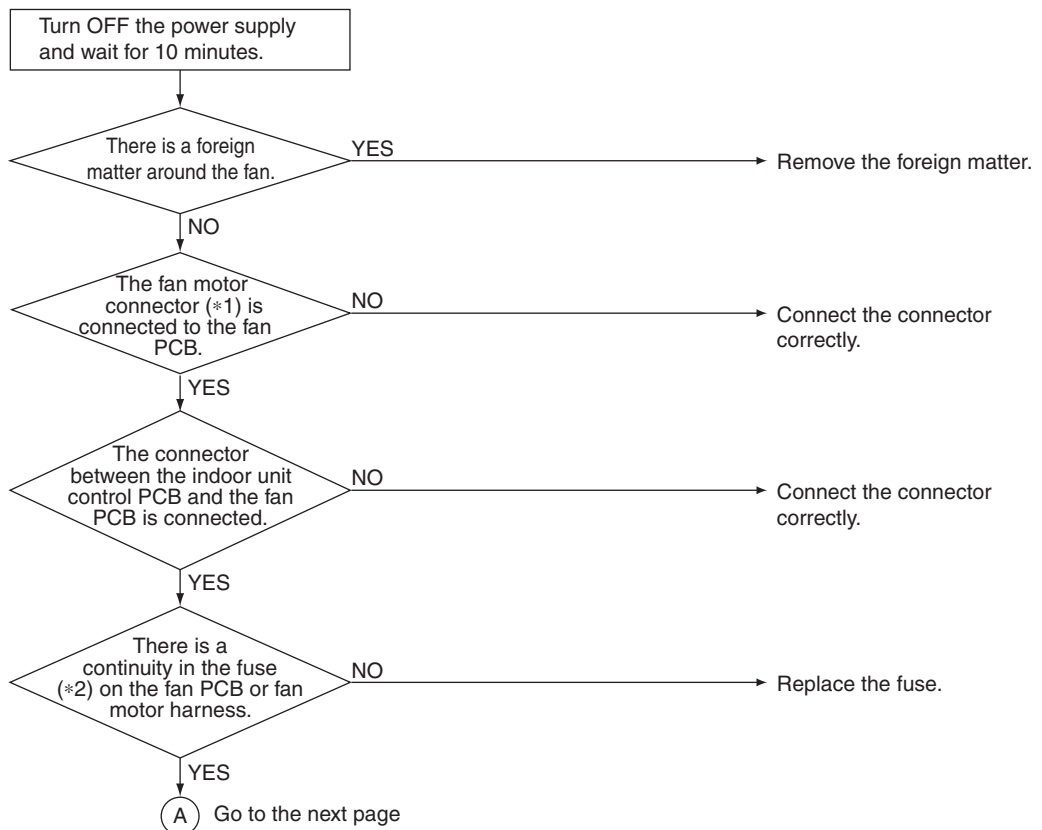

R6000547

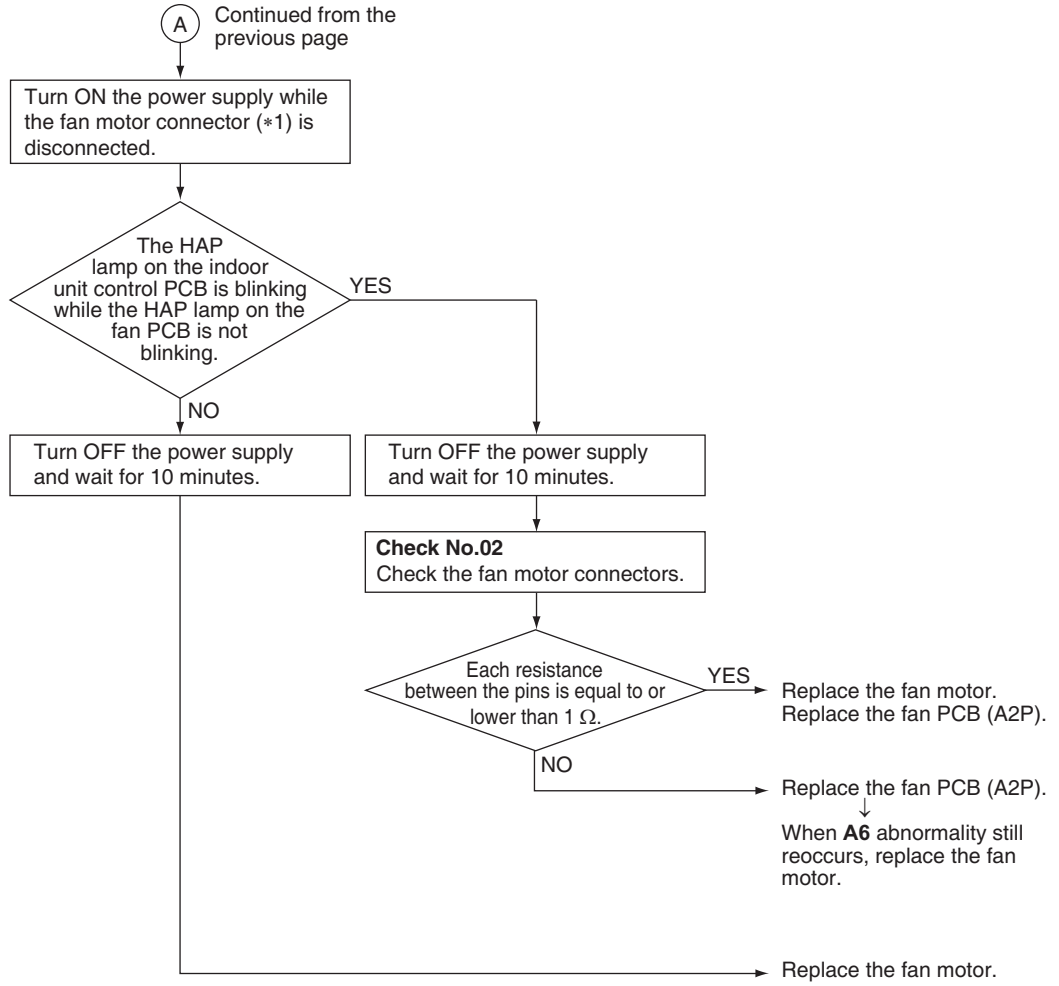

R6000961

**i** Note

Connector and indoor unit PCB

*1 Fan motor connector	*2 Fuse
X8A	F2U

**📄** Reference

**Check No.02** Refer to P.189

## 6.3.2 Indoor Fan Motor (DC Motor) or Related Abnormality

---

**Applicable Models**FFQ09/12/15/18W2VJU9

---

**Error Code****A6**

---

**Method of Error Detection**

The rotation speed detected by the Hall IC during indoor fan motor operation determines abnormal fan motor operation.

---

**Error Decision Conditions**

The fan motor is not revved up.

---

**Supposed Causes**

- Layer short inside the fan motor winding
- Breaking of wire inside the fan motor
- Breaking of the fan motor lead wires
- Defective indoor unit PCB

Troubleshooting

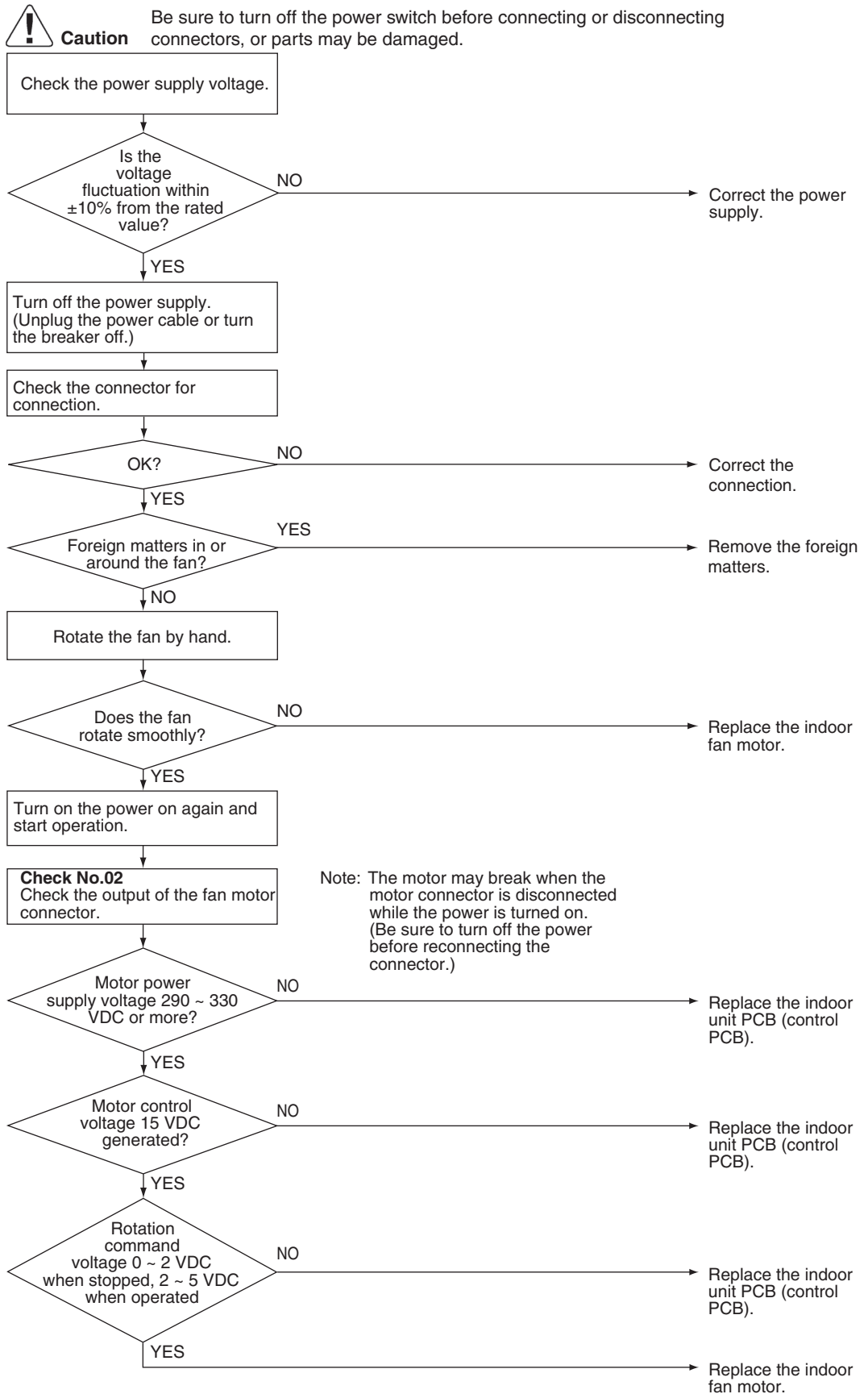

(R24054)





Reference

Check No.02 Refer to P.189

## 6.4 Indoor Fan PCB Abnormality

<b>Applicable Models</b>	FDMQ09/12/15/18/24WVJU9
<b>Error Code</b>	<b>A8</b>
<b>Method of Error Detection</b>	Microcomputer checks the voltage state of the fan PCB.
<b>Error Decision Conditions</b>	Overvoltage or voltage drop is detected on the fan PCB.
<b>Supposed Causes</b>	<ul style="list-style-type: none"> <li>■ Defective fan PCB</li> <li>■ External factor such as noise</li> </ul>

### Troubleshooting

 **Caution** Be sure to turn off the power switch before connecting or disconnecting connectors, or parts may be damaged.

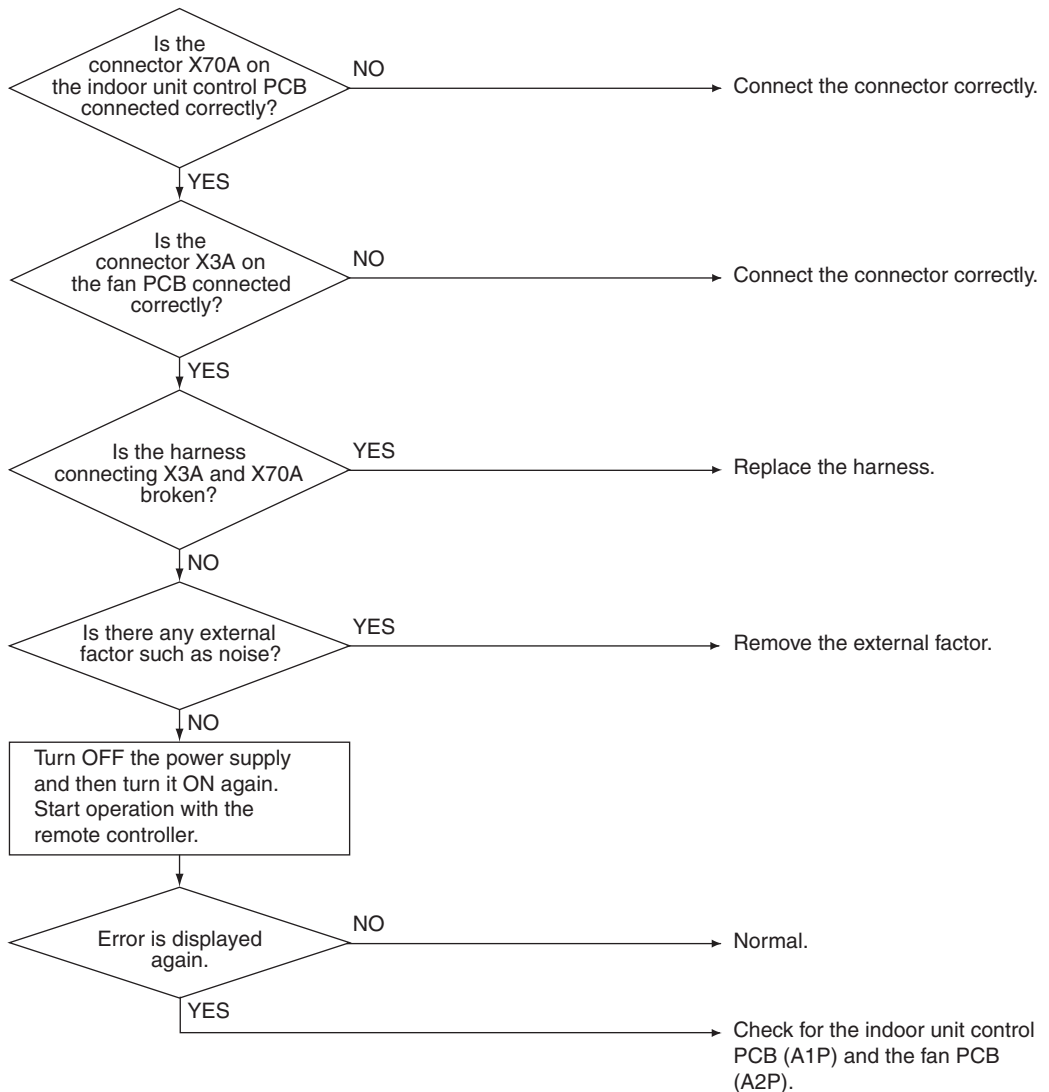

R6000549

## 6.5 Humidifier or Related Abnormality

<b>Error Code</b>	<b>AF</b>
<b>Method of Error Detection</b>	Water leakage from humidifier(s) is detected based on the float switch ON/OFF changeover while the system is not operating.
<b>Error Decision Conditions</b>	The float switch changes from ON to OFF while the system is OFF
<b>Supposed Causes</b>	<ul style="list-style-type: none"> <li>■ Defective float switch</li> <li>■ Error in water drain system of humidifier(s)</li> <li>■ Clogged electric expansion valve in humidifier(s)</li> <li>■ Defective indoor unit PCB</li> </ul>

### Troubleshooting

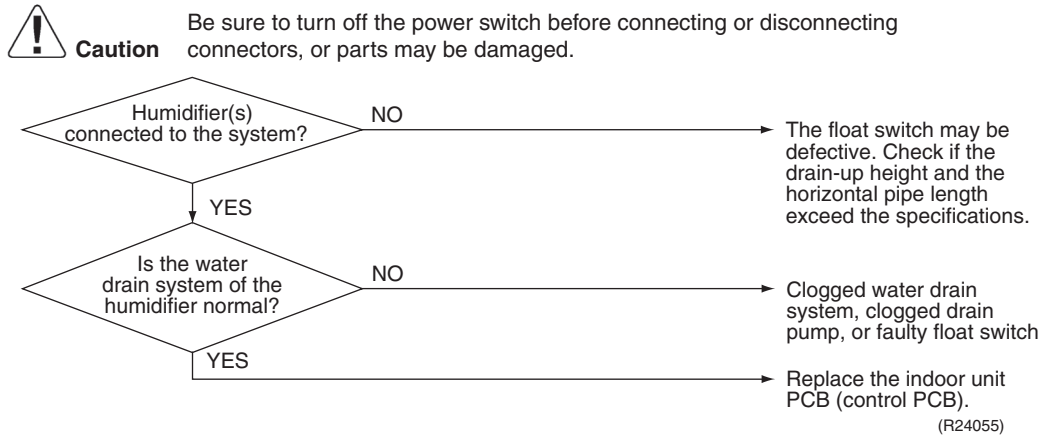

 **Note**

The system continues to operate with the thermostat OFF even while the error code is displayed.

## 6.6 Thermistor or Related Abnormality

<b>Error Code</b>	<b>C4, C5, C9</b>
<b>Method of Error Detection</b>	The temperatures detected by the thermistors determine thermistor errors.
<b>Error Decision Conditions</b>	The thermistor is disconnected or shorted while the unit is running.
<b>Supposed Causes</b>	<ul style="list-style-type: none"> <li>■ Disconnection of connector</li> <li>■ Defective thermistor(s)</li> <li>■ Breaking of wires</li> <li>■ Defective indoor unit PCB</li> </ul>
<b>Troubleshooting</b>	<p>If the cause of the problem is related to the thermistors, the thermistors should be checked prior to changing the indoor unit PCB.</p> <p>To check the thermistors, proceed as follows:</p> <ol style="list-style-type: none"> <li>1. Disconnect the thermistor from the indoor unit PCB.</li> <li>2. Read the temperature and the resistance value.</li> <li>3. Check if the measured values correspond with the values in the table of thermistor resistance check.</li> </ol>

 **Caution** Be sure to turn off the power switch before connecting or disconnecting connectors, or parts may be damaged.

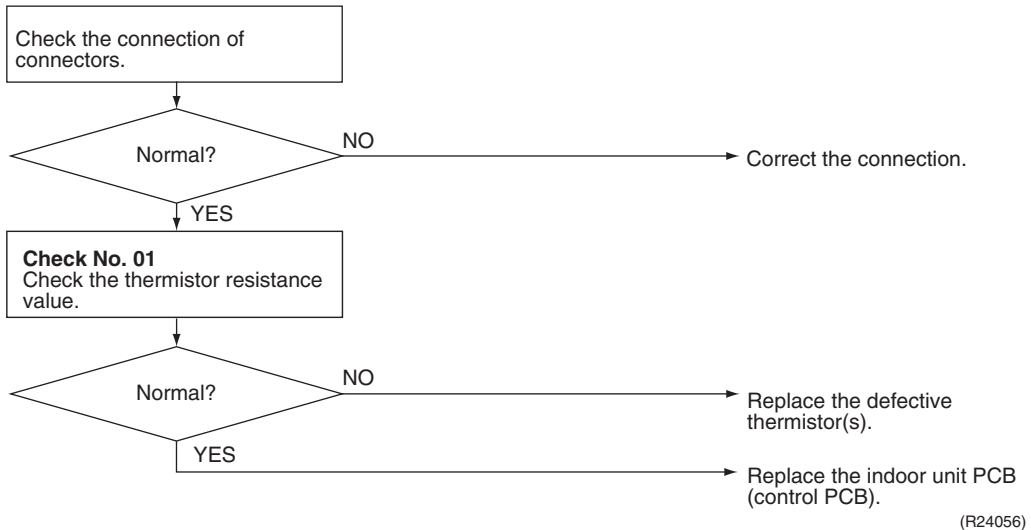

- C4:** Indoor heat exchanger thermistor 1 (liquid pipe) (R2T)
- C5:** Indoor heat exchanger thermistor 2 (R3T)
- C9:** Room temperature thermistor (R1T)



**Reference**

**Check No.01** Refer to P.188

## 6.7 Presence Sensor or Floor Sensor Abnormality

**Applicable Models** FFQ09/12/15/18W2VJU9

**Error Code** **CE**

**Method of Error Detection** The system detects abnormality by the output signal from the sensor(s).

**Error Decision Conditions** The sensor is disconnected or shorted while the unit is running.

**Supposed Causes**

- Disconnection of connector
- Breaking of wires
- Defective sensor(s)
- Defective sensor kit PCB

**Troubleshooting** If the cause of the problem is related to the sensors, the sensors should be checked prior to changing the indoor unit PCB.



**Caution**

Be sure to turn off the power switch before connecting or disconnecting connectors, or parts may be damaged.

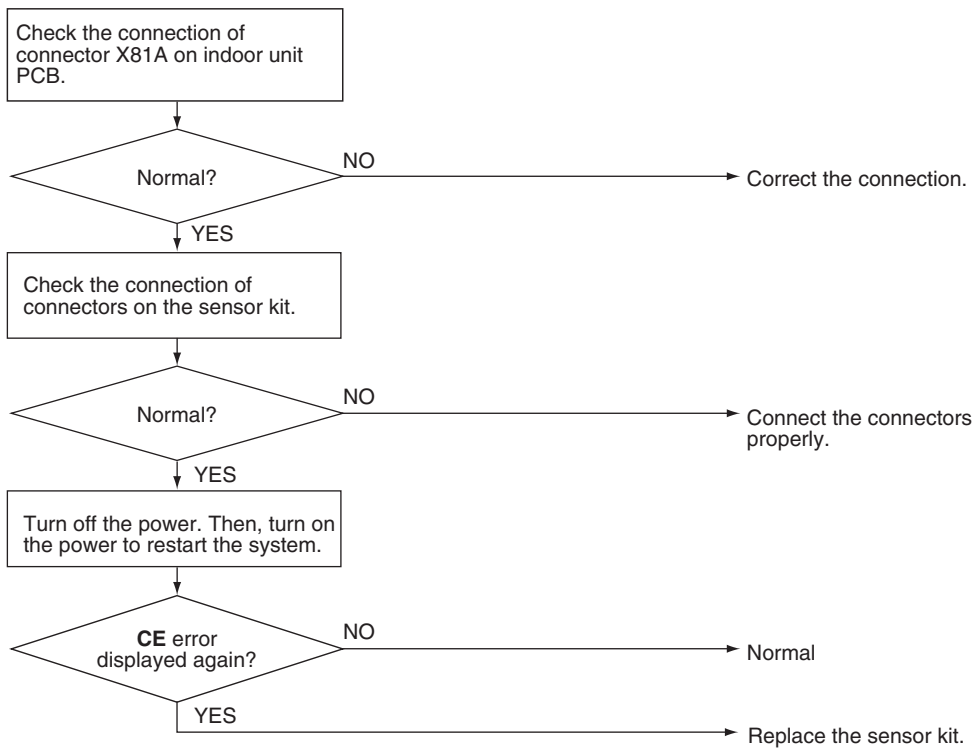

(R24577)



**Note**

When replacing the defective sensor(s), replace the sensor kit as ASSY.

## 6.8 Remote Controller Thermistor Abnormality

<b>Error Code</b>	<b>CJ</b>
<b>Method of Error Detection</b>	Even if remote controller thermistor is faulty, system is possible to operate by system thermistor. Malfunction detection is carried out by the temperature detected by the remote controller thermistor.
<b>Error Decision Conditions</b>	The remote controller thermistor is disconnected or shorted while the unit is running.
<b>Supposed Causes</b>	<ul style="list-style-type: none"> <li>■ Defective room temperature thermistor in the wired remote controller</li> <li>■ Defective wired remote controller PCB</li> <li>■ External factor such as noise</li> </ul>

### Troubleshooting

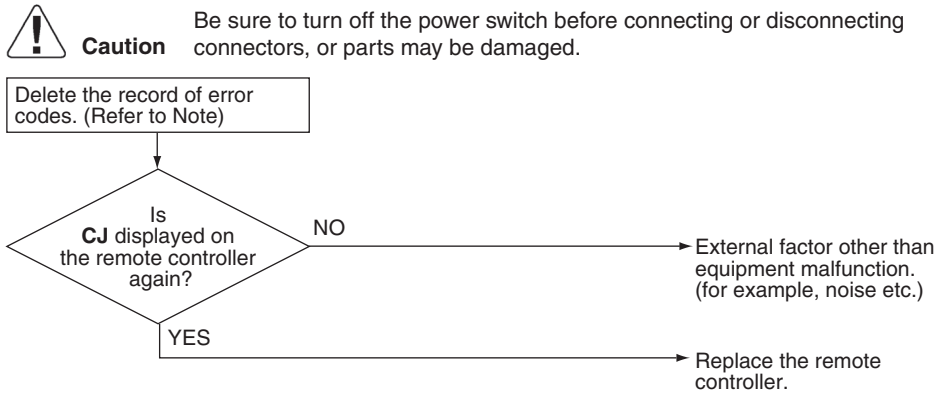

 **Note**

To delete the record of error codes, press **ON/OFF** button on the remote controller for 4 seconds or more while the error code is displayed in the inspection mode.

## 6.9 Low-voltage Detection or Over-voltage Detection

<b>Error Code</b>	<b>U2</b>
<b>Method of Error Detection</b>	<p><b>Low-voltage detection:</b> An abnormal voltage drop is detected by the DC voltage detection circuit.</p> <p><b>Over-voltage detection:</b> An abnormal voltage rise is detected by the over-voltage detection circuit.</p>
<b>Error Decision Conditions</b>	<p><b>Low-voltage detection:</b></p> <ul style="list-style-type: none"> <li>■ The voltage detected by the DC voltage detection circuit is below 180 ~ 196 V (depending on the model).</li> <li>■ The compressor stops if the error occurs, and restarts automatically after 3-minute standby.</li> </ul> <p><b>Over-voltage detection:</b></p> <ul style="list-style-type: none"> <li>■ An over-voltage signal is fed from the over-voltage detection circuit to the microcomputer (over 458 ~ 500 V, depending on the model).</li> <li>■ The compressor stops if the error occurs, and restarts automatically after 3-minute standby.</li> </ul>
<b>Supposed Causes</b>	<ul style="list-style-type: none"> <li>■ Power supply voltage out of specification</li> <li>■ Defective DC voltage detection circuit</li> <li>■ Defective over-voltage detection circuit</li> <li>■ Defective PAM control part</li> <li>■ Disconnection of compressor harness</li> <li>■ Short circuit inside the fan motor winding</li> <li>■ Noise</li> <li>■ Momentary drop of voltage</li> <li>■ Momentary power failure</li> <li>■ Defective outdoor unit PCB</li> </ul>

Troubleshooting

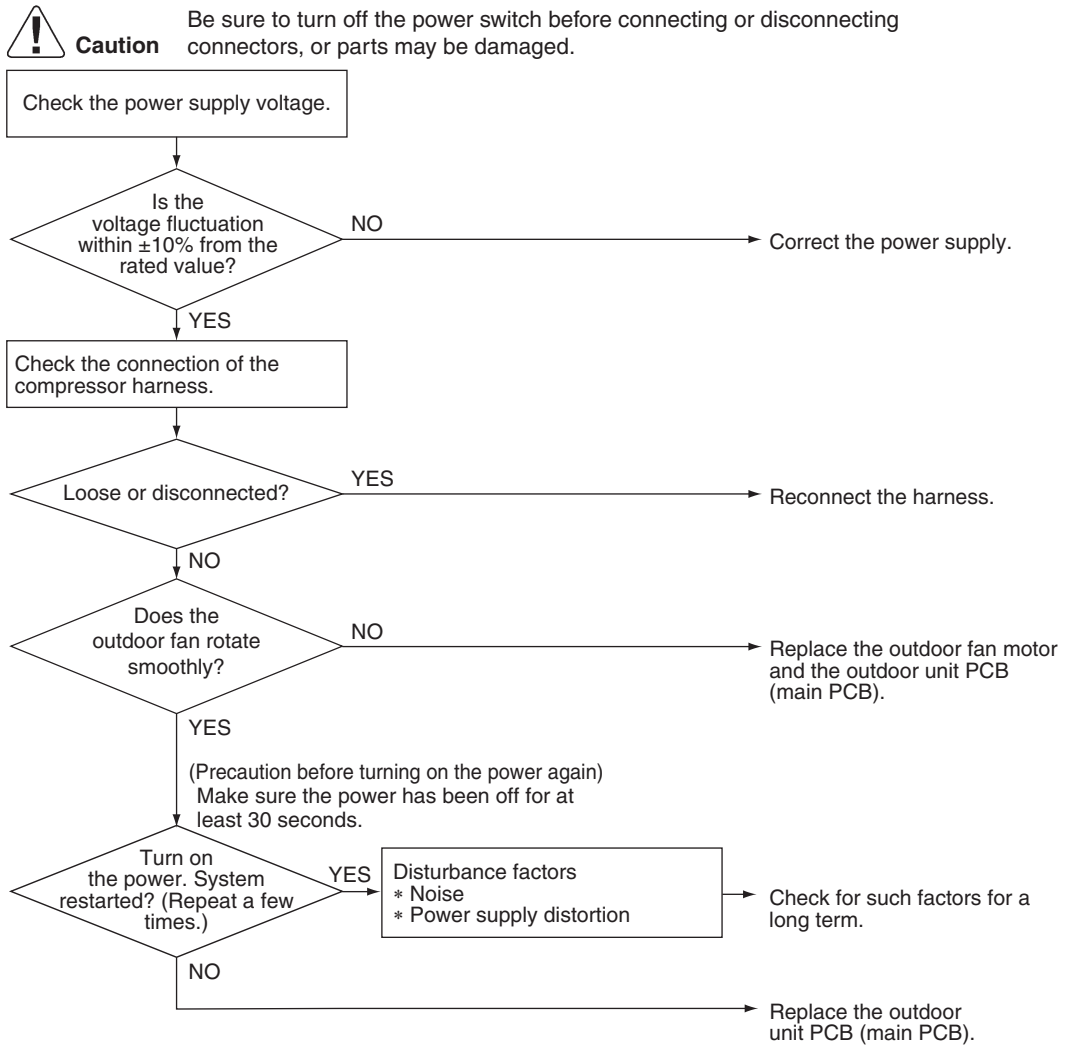

(R22445)



## 6.10 Signal Transmission Error (Between Indoor and Outdoor Unit)

---

**Error Code****U4**

---

**Method of Error Detection**

The signal transmission data from the outdoor unit is checked whether it is normal.

---

**Error Decision Conditions**

The data sent from the outdoor unit cannot be received normally, or the content of the data is abnormal.

---

**Supposed Causes**

- Power supply voltage out of specification
- Reduction of power supply voltage
- Wiring error
- Breaking of the connection wires between the indoor and outdoor units (wire No. 3)
- Defective outdoor unit PCB
- Short circuit inside the fan motor winding
- Defective indoor unit PCB
- Disturbed power supply waveform

Troubleshooting

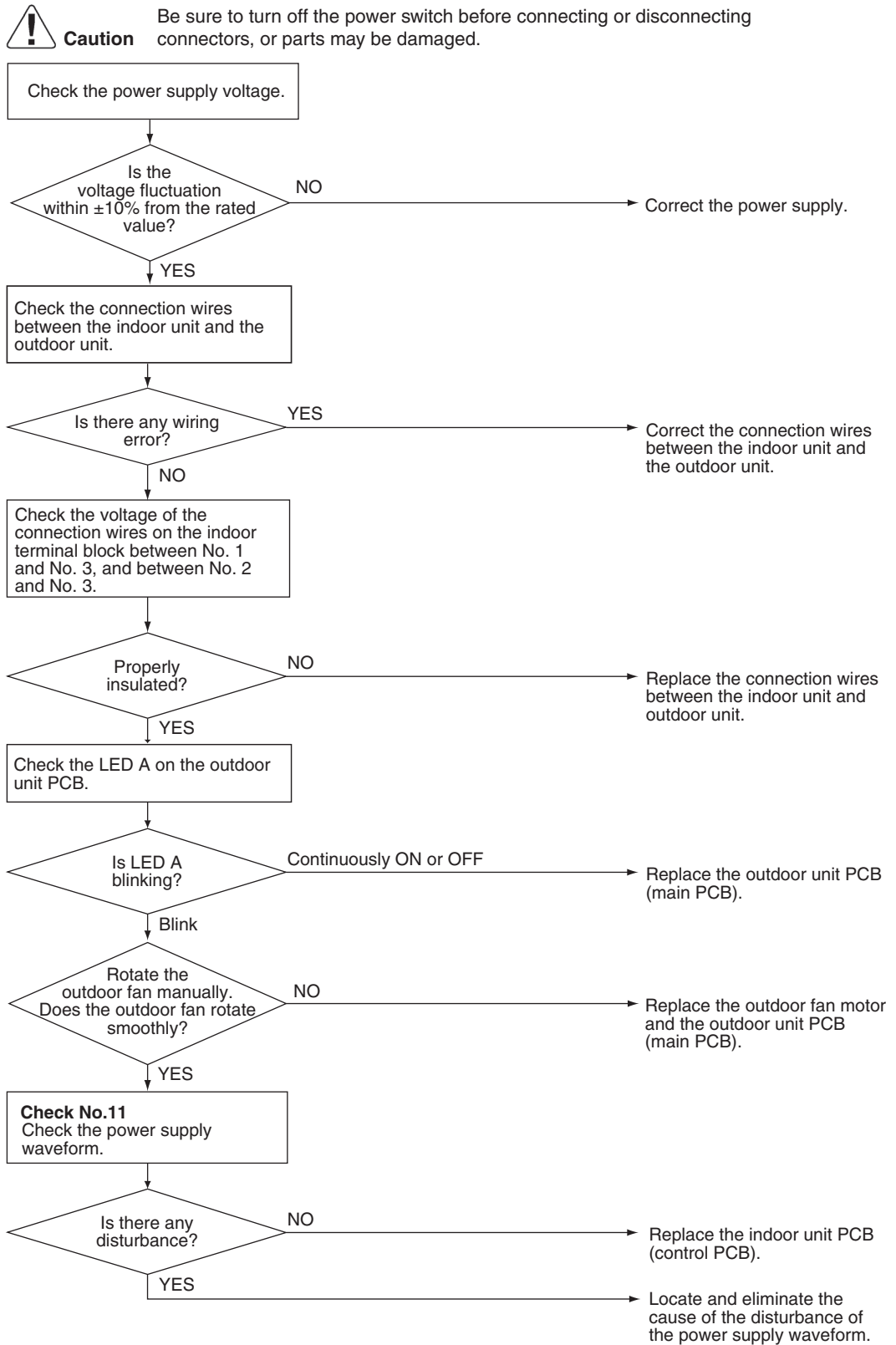

(R24622)



Reference **Check No.11** Refer to P.190

# 6.11 Signal Transmission Error (Between Indoor Unit and Remote Controller)

**Error Code**

**U5**

**Method of Error Detection**

In case of controlling 1 indoor unit with 2 remote controllers, check the system using microcomputer if signal transmission between indoor unit and remote controller (main and sub) is normal.

**Error Decision Conditions**

Normal transmission does not continue for specified period.

**Supposed Causes**

- Connection of 2 main remote controllers (when using 2 remote controllers)
- Defective indoor unit PCB
- Defective remote controller
- Transmission error caused by noise

**Troubleshooting**

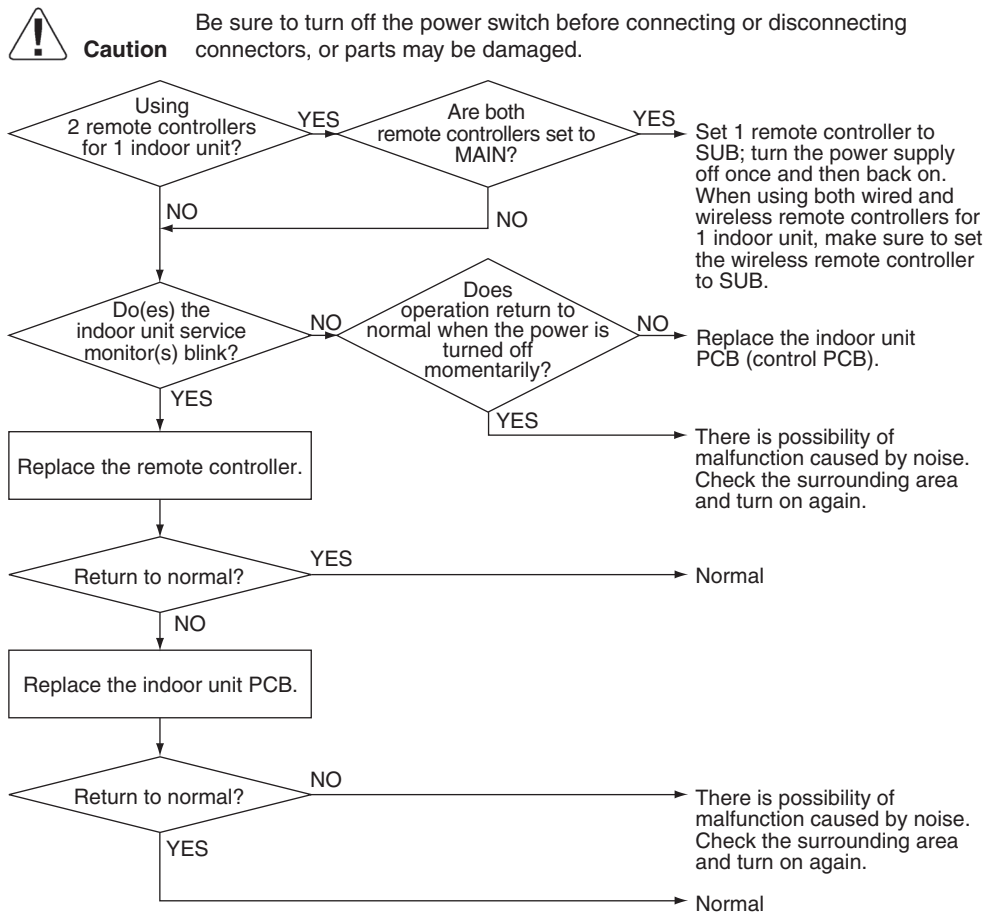

(R24590)



**Note**

For the way to change MAIN/SUB setting of remote controllers, refer to pages 217 and 218.

## 6.12 Signal Transmission Error (Between MAIN/SUB Remote Controllers)

**Error Code**

**U8**

**Method of Error Detection**

In case of controlling 1 indoor unit with 2 remote controllers, check the system using microcomputer if signal transmission between MAIN remote controller and SUB remote controller is normal.

**Error Decision Conditions**

Normal transmission does not continue for specified period.

**Supposed Causes**

- Remote controller is set to SUB when using 1 remote controller
- Connection of 2 SUB remote controllers (when using 2 remote controllers)
- Defective remote controller PCB

**Troubleshooting**



**Caution**

Be sure to turn off the power switch before connecting or disconnecting connectors, or parts may be damaged.

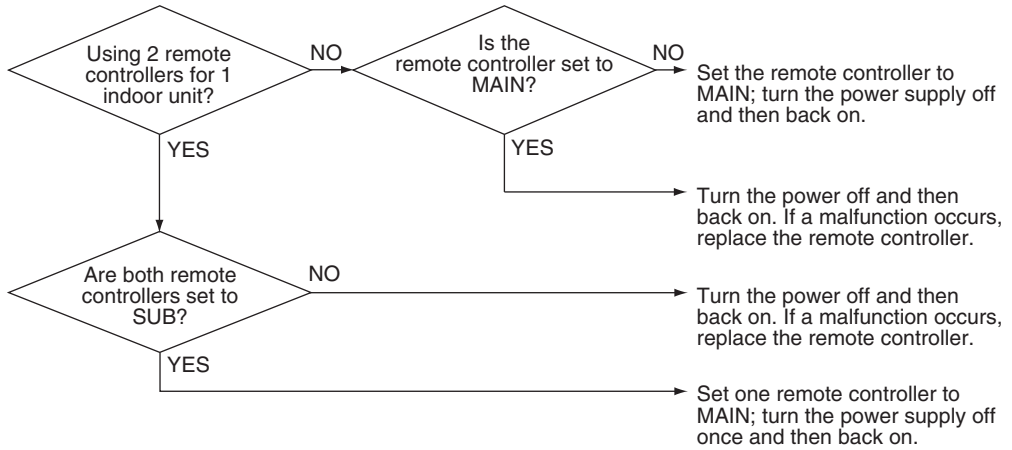

(R24058)



**Note**

For the way to change MAIN/SUB setting of remote controllers, refer to pages 217 and 218.

# 6.13 Unspecified Voltage (Between Indoor Unit and Outdoor Unit)

Error Code

**UA**

Error Decision Conditions

Improper combination of indoor and outdoor units

Supposed Causes

- Defective indoor unit PCB
- Indoor-outdoor unit transmission wiring error
- Defective optional unit(s) wirings
- Improper power supply wiring of indoor unit
- Improper wiring of connecting wires between indoor/outdoor units

Troubleshooting

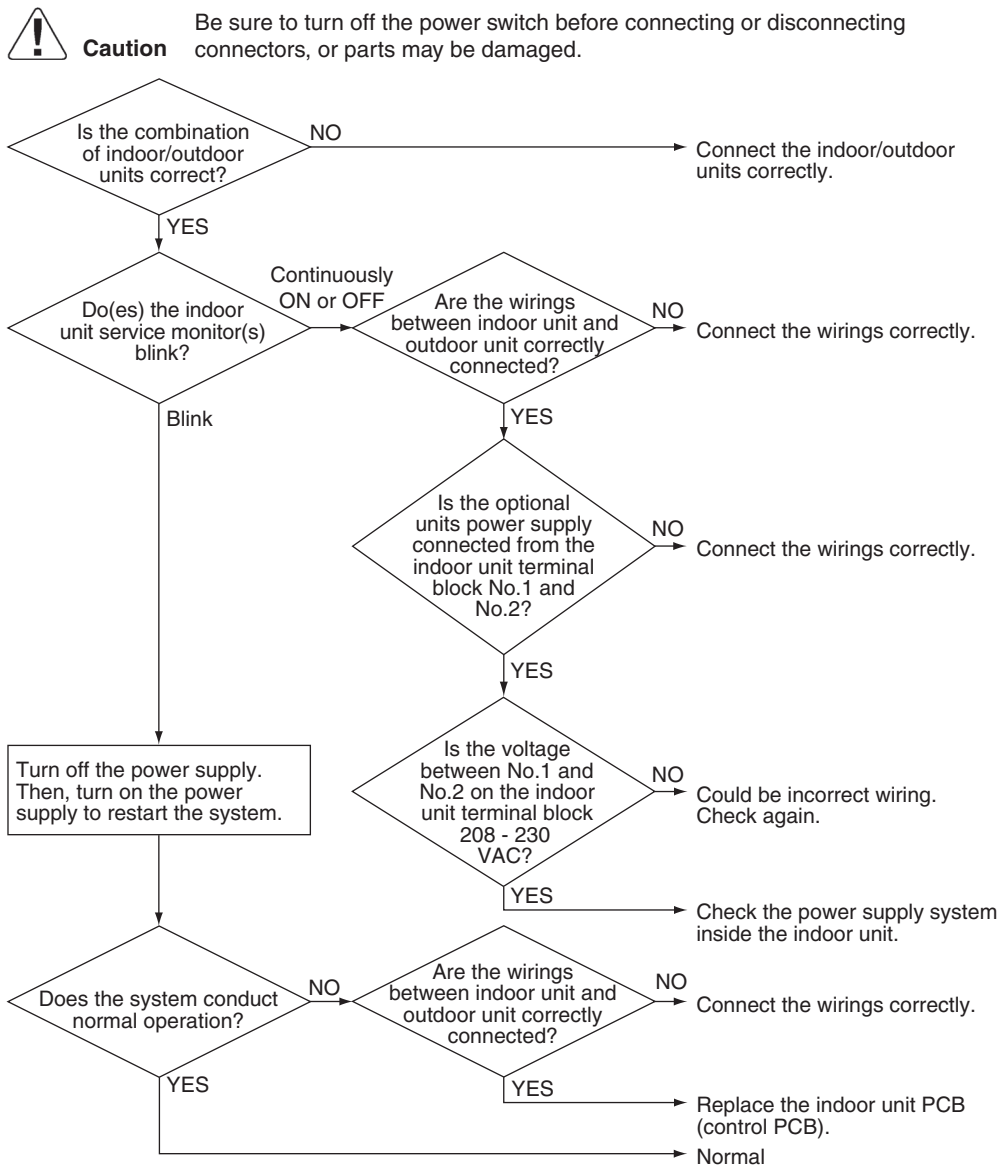

(R24591)

# 7. Troubleshooting for Outdoor Unit

## 7.1 Outdoor Unit PCB Abnormality

<b>Error Code</b>	<b>E1</b>
<b>Method of Error Detection</b>	<ul style="list-style-type: none"> <li>■ The system checks if the microprocessor is working in order.</li> <li>■ The system checks if the zero-cross signal comes in properly.</li> </ul>
<b>Error Decision Conditions</b>	<ul style="list-style-type: none"> <li>■ The microprocessor program runs out of control.</li> <li>■ The zero-cross signal is not detected.</li> </ul>
<b>Supposed Causes</b>	<ul style="list-style-type: none"> <li>■ Defective outdoor unit PCB</li> <li>■ Noise</li> <li>■ Momentary drop of voltage</li> <li>■ Momentary power failure</li> </ul>

**Troubleshooting**

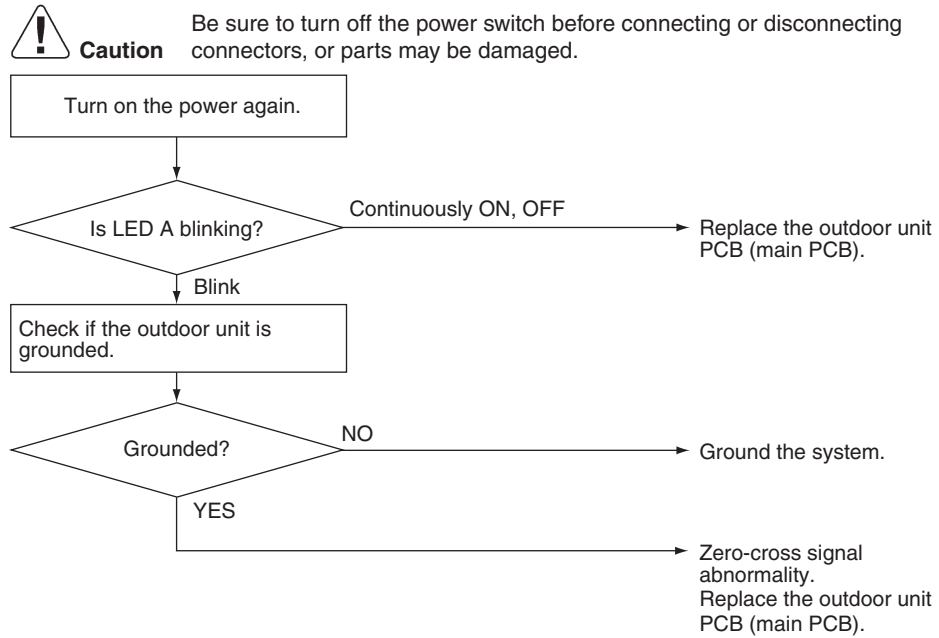

(R24717)

## 7.2 Actuation of High Pressure Switch

---

**Applicable Models** RX15/18/24WMVJU9

---

**Error Code** **E3**

---

**Method of Error Detection** Abnormality is detected when the contact of the high pressure switch opens.

---

**Error Decision Conditions**

- High pressure switch (S1PH) activating pressure: 4.15 MPa (602 psi)
- High pressure switch (S1PH) recovery pressure: 3.2 MPa (464 psi)

---

**Supposed Causes**

- Actuation of high pressure switch (S1PH)
- Closed stop valve
- Disconnection of connector S40
- Disconnection of 2 terminals of high pressure switch (S1PH)
- Defective outdoor unit PCB
- Broken S1PH harness
- Defective high pressure switch (S1PH)

Troubleshooting



**Caution** Be sure to turn off the power switch before connecting or disconnecting connectors, or parts may be damaged.

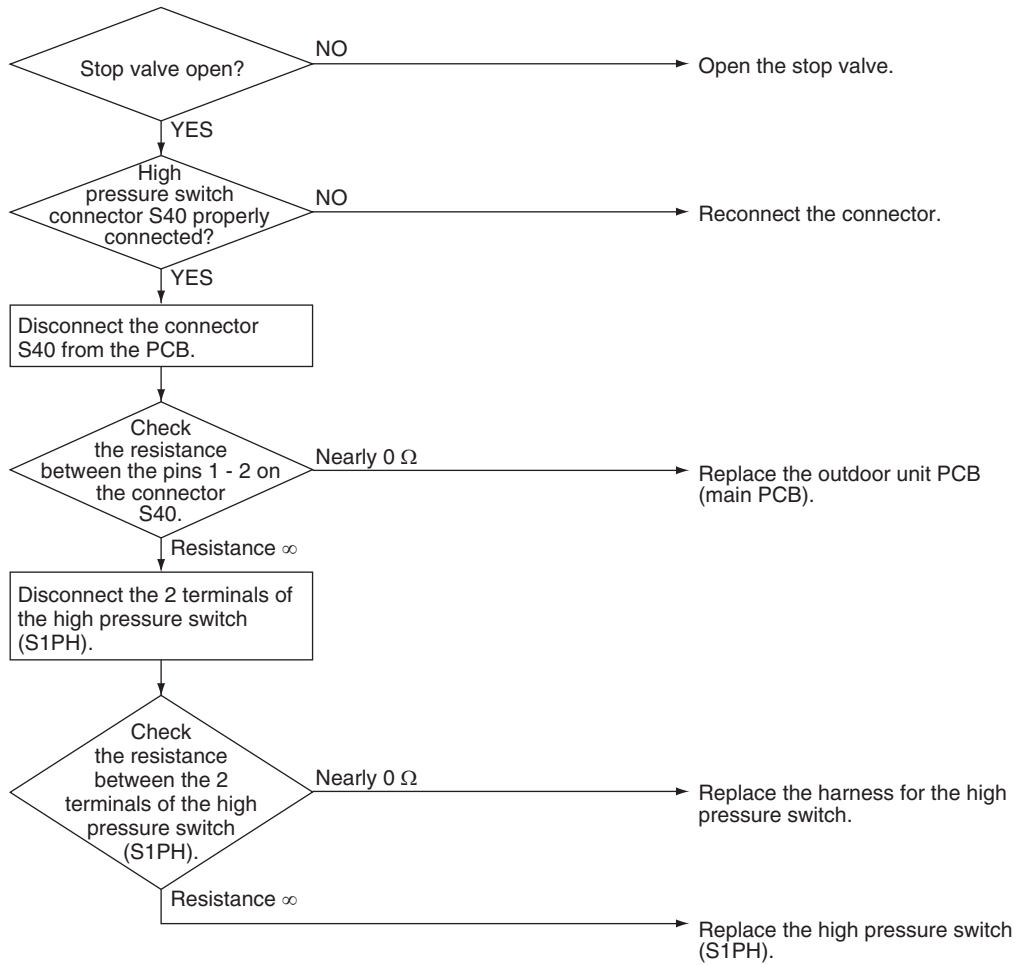

(R22435)



## 7.3 OL Activation (Compressor Overload) or HPS Activation (High Pressure Switch)

<b>Applicable Models</b>	RX09/12WMVJU9
<b>Error Code</b>	<b>E5</b>
<b>Method of Error Detection</b>	A compressor overload is detected through compressor OL. Abnormality is detected when the contact of the high pressure switch opens.
<b>Error Decision Conditions</b>	<ul style="list-style-type: none"> <li>■ If the error repeats, the system is shut down.</li> <li>■ Reset condition: Continuous run for about 60 minutes without any other error</li> </ul>
<b>Supposed Causes</b>	<ul style="list-style-type: none"> <li>■ Disconnection of discharge pipe thermistor</li> <li>■ Disconnection of indoor or outdoor heat exchanger thermistor</li> <li>■ Defective discharge pipe thermistor</li> <li>■ Defective indoor or outdoor heat exchanger thermistor</li> <li>■ Disconnection of connector S40</li> <li>■ Disconnection of 2 terminals of OL (Q1L)</li> <li>■ Disconnection of 2 terminals of HPS (S1PH)</li> <li>■ Defective OL (Q1L)</li> <li>■ Defective HPS (S1PH)</li> <li>■ Broken OL and HPS harness</li> <li>■ Defective electronic expansion valve or coil</li> <li>■ Defective four way valve or coil</li> <li>■ Defective outdoor unit PCB</li> <li>■ Refrigerant shortage</li> <li>■ Water mixed in refrigerant</li> <li>■ Defective stop valve</li> </ul>

Troubleshooting



**Caution** Be sure to turn off the power switch before connecting or disconnecting connectors, or parts may be damaged.

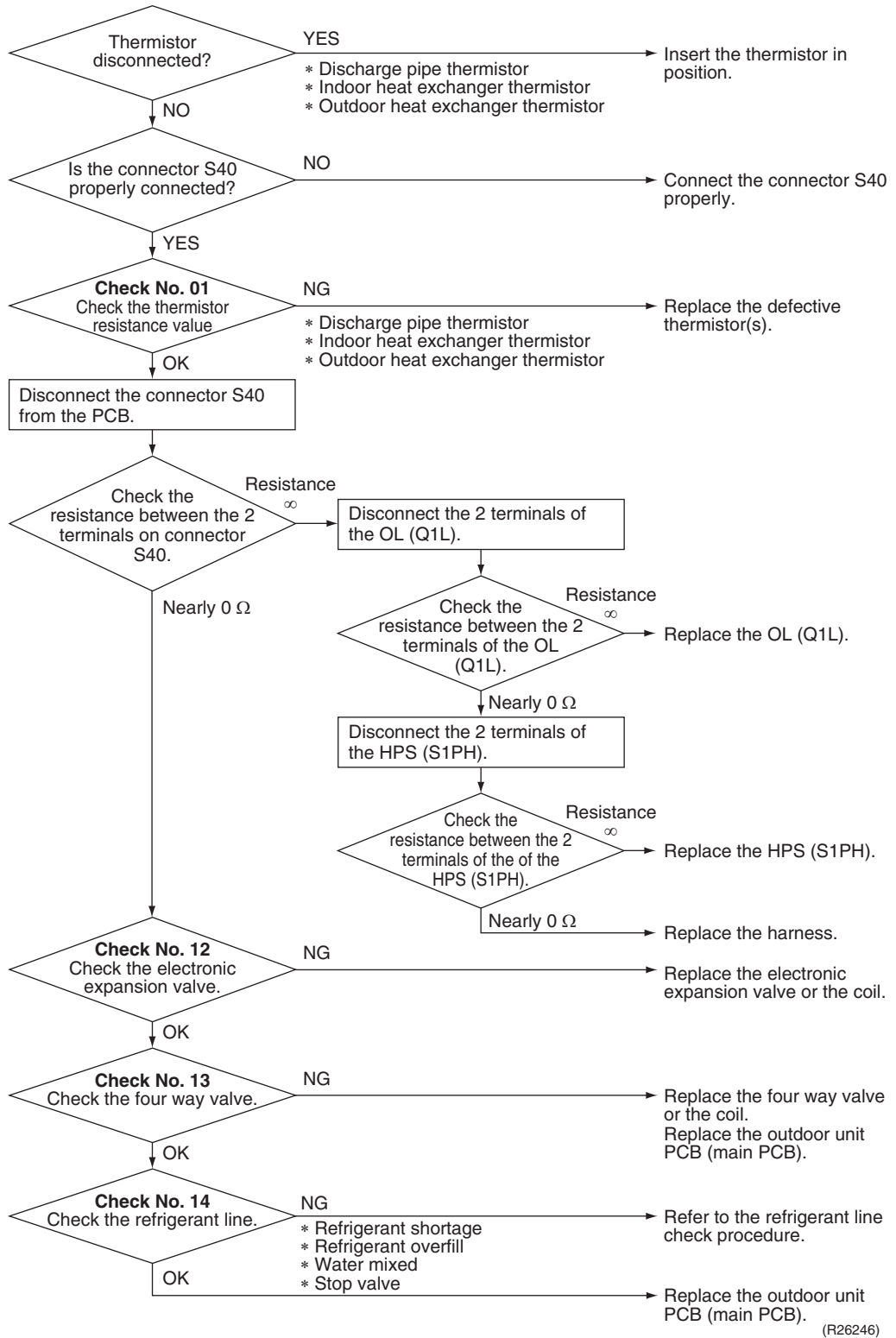

(R26246)

**Note(s)**

OL (Q1L) activating temperature: 130°C (266°F)

OL (Q1L) recovery temperature: 95°C (203°F)

High pressure switch (S1PH) activating pressure: 602 psi (4.15 MPa)

High pressure switch (S1PH) recovery pressure: 464 psi (3.2 MPa)

**Reference**

**Check No.01** Refer to P.188

**Reference**

**Check No.12** Refer to P.191

**Reference**

**Check No.13** Refer to P.192

**Reference**

**Check No.14** Refer to P.192

## 7.4 OL Activation (Compressor Overload)

<b>Applicable Models</b>	RX15/18/24WMVJU9
<b>Error Code</b>	<b>E5</b>
<b>Method of Error Detection</b>	A compressor overload is detected through compressor OL.
<b>Error Decision Conditions</b>	<ul style="list-style-type: none"> <li>■ If the error repeats, the system is shut down.</li> <li>■ Reset condition: Continuous run for about 60 minutes without any other error</li> </ul>
<b>Supposed Causes</b>	<ul style="list-style-type: none"> <li>■ Disconnection of discharge pipe thermistor</li> <li>■ Defective discharge pipe thermistor</li> <li>■ Disconnection of connector S40</li> <li>■ Disconnection of 2 terminals of OL (Q1M)</li> <li>■ Defective OL (Q1M)</li> <li>■ Broken OL harness</li> <li>■ Defective electronic expansion valve or coil</li> <li>■ Defective four way valve or coil</li> <li>■ Defective outdoor unit PCB</li> <li>■ Refrigerant shortage</li> <li>■ Water mixed in refrigerant</li> <li>■ Defective stop valve</li> </ul>

Troubleshooting



**Caution** Be sure to turn off the power switch before connecting or disconnecting connectors, or parts may be damaged.

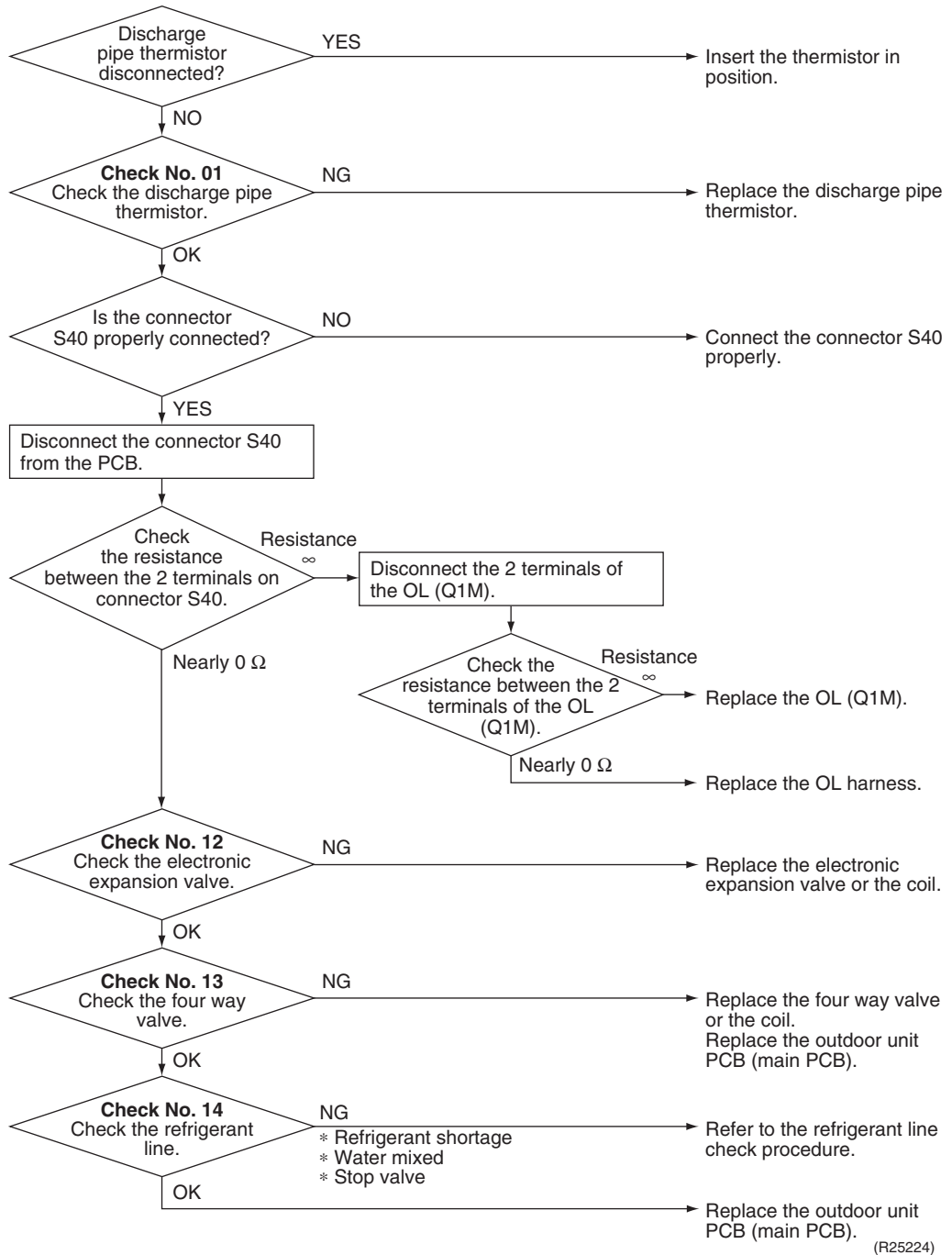

**Note** OL (Q1M) activating temperature: 130°C (266°F)  
OL (Q1M) recovery temperature: 95°C (203°F)



**Reference** Check No.01 Refer to P.188



**Reference** Check No.12 Refer to P.191



**Reference**    **Check No.13** Refer to P.192



**Reference**    **Check No.14** Refer to P.192

# 7.5 Compressor Lock

<b>Error Code</b>	<b>E6</b>
<b>Method of Error Detection</b>	A compressor lock is detected by the current waveform generated when applying high-frequency voltage to the motor.
<b>Error Decision Conditions</b>	<ul style="list-style-type: none"> <li>■ If the error repeats, the system is shut down.</li> <li>■ Reset condition: Continuous run for about 11 minutes without any other error</li> </ul>
<b>Supposed Causes</b>	<ul style="list-style-type: none"> <li>■ Closed stop valve</li> <li>■ Compressor locked</li> <li>■ Disconnection of compressor harness</li> </ul>

**Troubleshooting**



**Caution** Be sure to turn off the power switch before connecting or disconnecting connectors, or parts may be damaged.  
 (Precaution before turning on the power again)  
 Make sure the power has been off for at least 30 seconds.

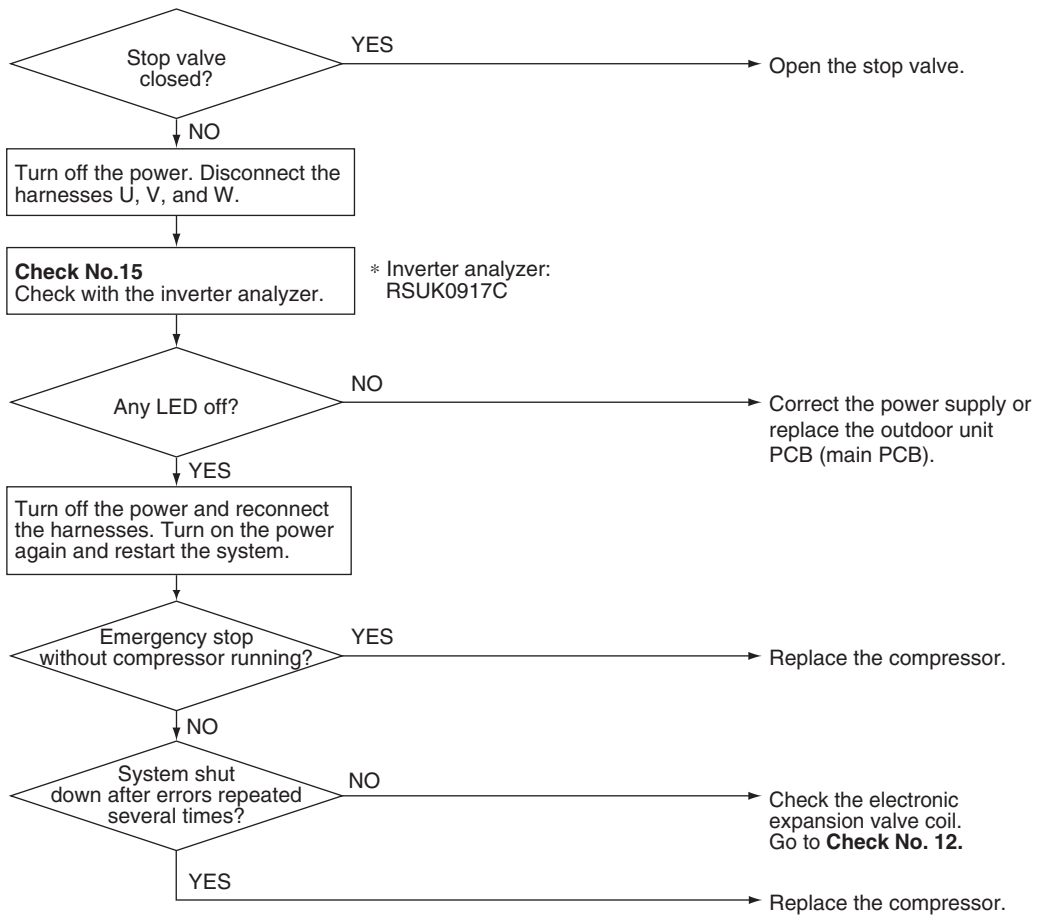

(R21067)



**Reference** **Check No.12** Refer to P.191



**Reference** **Check No.15** Refer to P.193

## 7.6 DC Fan Lock

<b>Error Code</b>	<b>E7</b>
<b>Method of Error Detection</b>	An error is determined with the high-voltage fan motor rotation speed detected by the Hall IC.
<b>Error Decision Conditions</b>	<ul style="list-style-type: none"> <li>■ The fan does not start in 15 ~ 30 seconds even when the fan motor is running.</li> <li>■ If the error repeats, the system is shut down.</li> <li>■ Reset condition: Continuous run for about 11 minutes without any other error</li> </ul>
<b>Supposed Causes</b>	<ul style="list-style-type: none"> <li>■ Disconnection of the fan motor</li> <li>■ Foreign matter stuck in the fan</li> <li>■ Defective fan motor</li> <li>■ Defective outdoor unit PCB</li> </ul>

### Troubleshooting

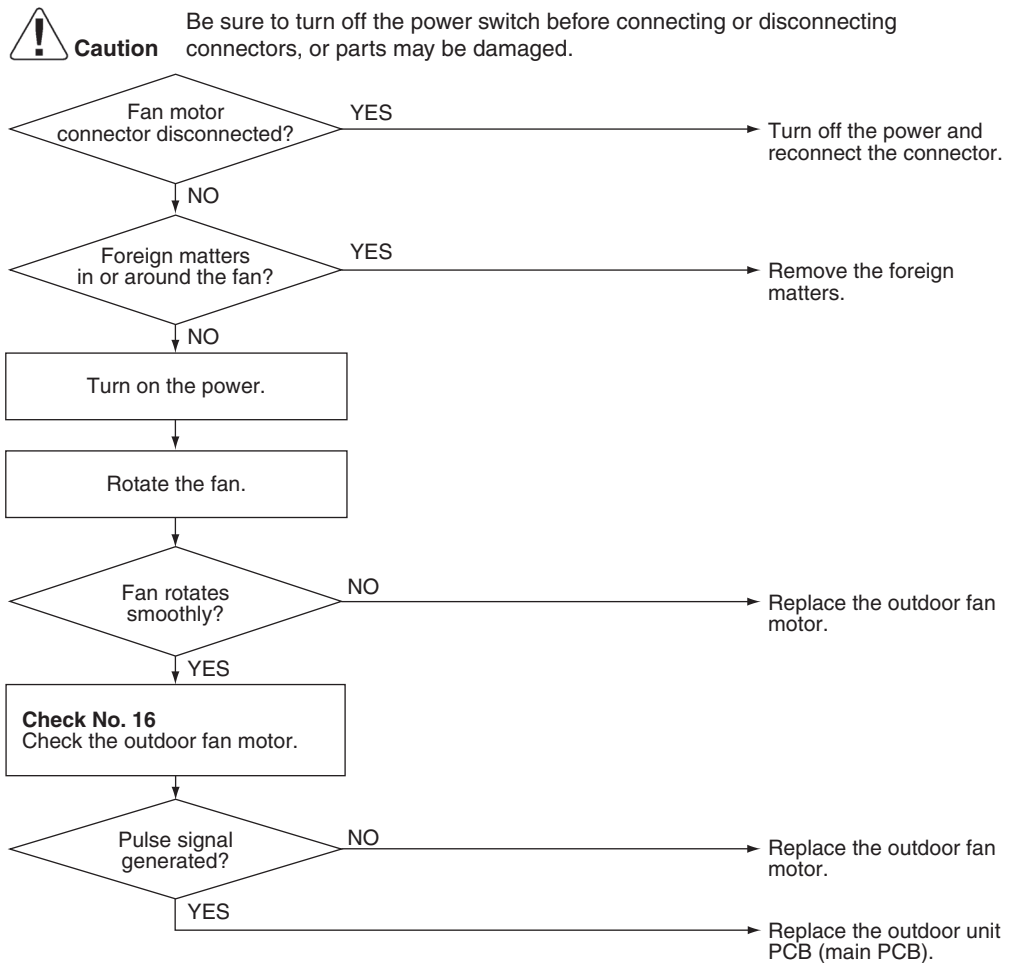

R6000892



Reference

**Check No.16** Refer to P.196



## 7.7 Input Overcurrent Detection

---

<b>Error Code</b>	<b>E8</b>
<b>Method of Error Detection</b>	An input overcurrent is detected by checking the input current value with the compressor running.
<b>Error Decision Conditions</b>	The current exceeds about 12.0 ~ 12.5 A (depending on the model) for 2.5 seconds with the compressor running. The upper limit of the current decreases when the outdoor temperature exceeds a certain level.
<b>Supposed Causes</b>	<ul style="list-style-type: none"><li>■ Outdoor temperature is out of operation range.</li><li>■ Defective compressor</li><li>■ Defective power module</li><li>■ Defective outdoor unit PCB</li><li>■ Short circuit</li></ul>



Troubleshooting

 **Caution** Be sure to turn off the power switch before connecting or disconnecting connectors, or parts may be damaged.

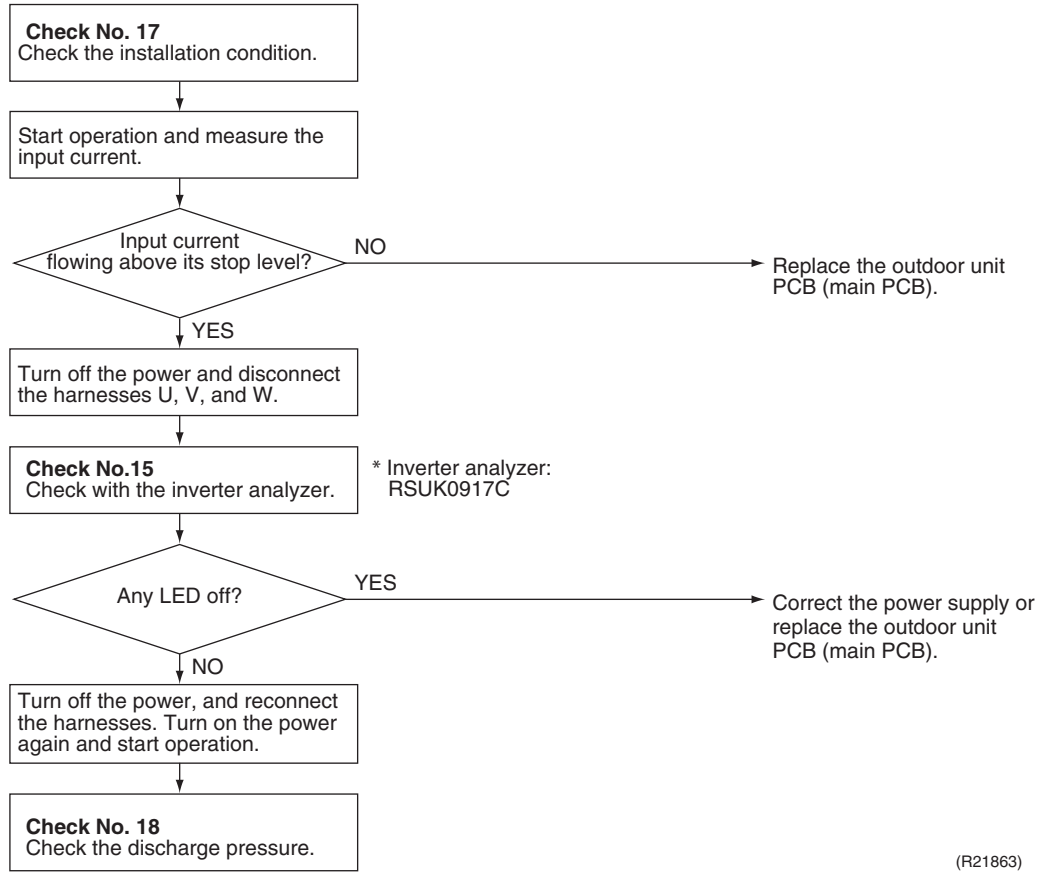
\* An input overcurrent may result from wrong internal wiring. If the system is interrupted by an input overcurrent after the wires have been disconnected and reconnected for part replacement, check the wiring again.



(R21863)

-  **Reference**    **Check No.15** Refer to P.193
-  **Reference**    **Check No.17** Refer to P.197
-  **Reference**    **Check No.18** Refer to P.197

## 7.8 Four Way Valve Abnormality

<b>Error Code</b>	<b>EA</b>
<b>Method of Error Detection</b>	The room temperature thermistor and the indoor heat exchanger thermistor are checked if they function within their normal ranges in each operation mode.
<b>Error Decision Conditions</b>	<p>The following condition continues over 10 minutes after operating for 5 minutes.</p> <ul style="list-style-type: none"> <li>■ Cooling/Dry  <math>A - B &lt; -5^{\circ}\text{C}</math> (<math>A - B &lt; -9^{\circ}\text{F}</math>)</li> <li>■ Heating  <math>B - A &lt; -5^{\circ}\text{C}</math> (<math>B - A &lt; -9^{\circ}\text{F}</math>)</li> </ul> <p>A: Room thermistor temperature  B: Indoor heat exchanger temperature</p> <ul style="list-style-type: none"> <li>■ If the error repeats, the system is shut down.</li> <li>■ Reset condition: Continuous run for about 60 minutes without any other error</li> </ul>
<b>Supposed Causes</b>	<ul style="list-style-type: none"> <li>■ Disconnection of four way valve coil</li> <li>■ Defective four way valve, coil, or harness</li> <li>■ Defective outdoor unit PCB</li> <li>■ Defective thermistor</li> <li>■ Refrigerant shortage</li> <li>■ Water mixed in refrigerant</li> <li>■ Defective stop valve</li> </ul>

Troubleshooting

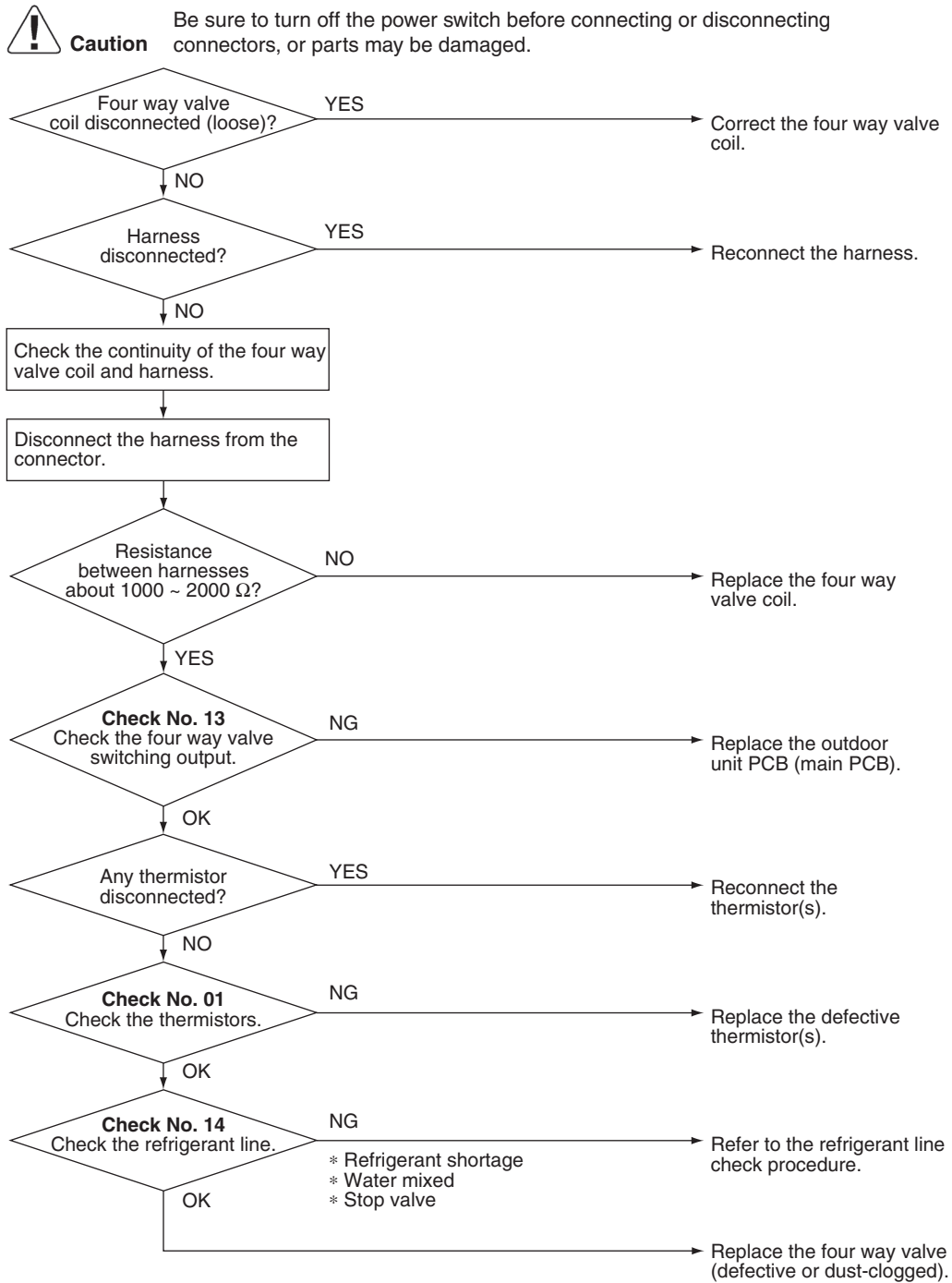

(R20405)



**Reference** Check No.01 Refer to P.188



**Reference** Check No.13 Refer to P.192



**Reference** Check No.14 Refer to P.192

## 7.9 Discharge Pipe Temperature Control

<b>Error Code</b>	<b>F3</b>																			
<b>Method of Error Detection</b>	An error is determined with the temperature detected by the discharge pipe thermistor.																			
<b>Error Decision Conditions</b>	<ul style="list-style-type: none"> <li>■ If the temperature detected by the discharge pipe thermistor rises above <b>A</b>, the compressor stops.</li> <li>■ The error is cleared when the discharge pipe temperature has dropped below <b>B</b>.</li> <li>■ If the error repeats, the system is shut down.</li> <li>■ Reset condition: Continuous run for about 60 minutes without any other error</li> </ul>																			
	<table border="1"> <thead> <tr> <th rowspan="2"></th> <th colspan="2"><b>A</b></th> <th colspan="2"><b>B</b></th> </tr> <tr> <th>°C</th> <th>°F</th> <th>°C</th> <th>°F</th> </tr> </thead> <tbody> <tr> <td>09/12 class</td> <td>110</td> <td>230</td> <td>88</td> <td>190.4</td> </tr> <tr> <td>15/18/24 class</td> <td>110</td> <td>230</td> <td>95</td> <td>203</td> </tr> </tbody> </table> <p>★ If the frequency drops, the temperature is lowered in compensation.</p>		<b>A</b>		<b>B</b>		°C	°F	°C	°F	09/12 class	110	230	88	190.4	15/18/24 class	110	230	95	203
	<b>A</b>		<b>B</b>																	
	°C	°F	°C	°F																
09/12 class	110	230	88	190.4																
15/18/24 class	110	230	95	203																
<b>Supposed Causes</b>	<ul style="list-style-type: none"> <li>■ Defective discharge pipe thermistor (Defective outdoor heat exchanger thermistor or outdoor temperature thermistor)</li> <li>■ Defective electronic expansion valve or coil</li> <li>■ Refrigerant shortage</li> <li>■ Defective four way valve</li> <li>■ Water mixed in refrigerant</li> <li>■ Defective stop valve</li> <li>■ Defective outdoor unit PCB</li> </ul>																			

### Troubleshooting



**Caution**

Be sure to turn off the power switch before connecting or disconnecting connectors, or parts may be damaged.

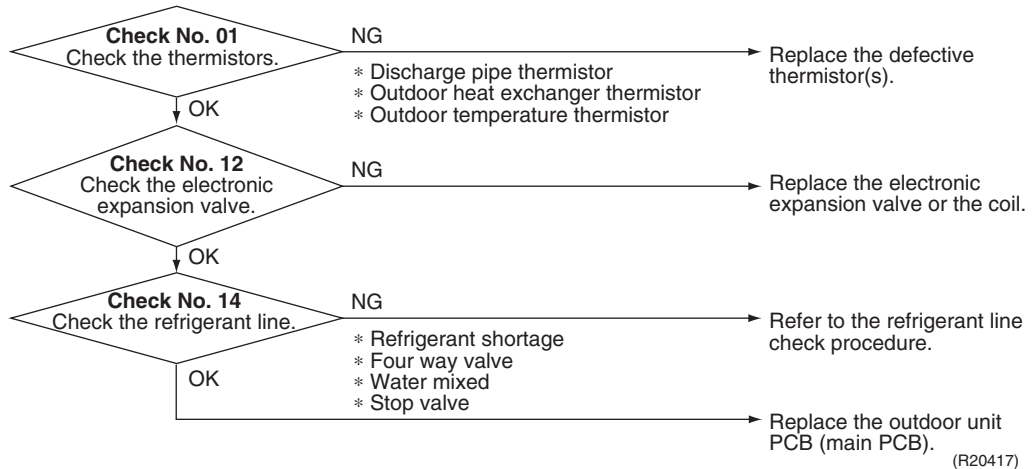

Reference

**Check No.01** Refer to P.188



Reference

**Check No.12** Refer to P.191



Reference

**Check No.14** Refer to P.192

## 7.10 High Pressure Control in Cooling

<b>Error Code</b>	<b>F6</b>
<b>Method of Error Detection</b>	High-pressure control (operation halt, frequency drop, etc.) is activated in cooling operation if the temperature sensed by the outdoor heat exchanger thermistor exceeds the limit.
<b>Error Decision Conditions</b>	The temperature sensed by the outdoor heat exchanger thermistor rises above 57.5 ~ 60°C (135.5 ~ 140°F) (depending on the model).
<b>Supposed Causes</b>	<ul style="list-style-type: none"> <li>■ Installation space not large enough</li> <li>■ Dirty outdoor heat exchanger</li> <li>■ Defective outdoor fan motor</li> <li>■ Defective stop valve</li> <li>■ Defective electronic expansion valve or coil</li> <li>■ Defective outdoor heat exchanger thermistor</li> <li>■ Defective outdoor unit PCB</li> </ul>

Troubleshooting



**Caution** Be sure to turn off the power switch before connecting or disconnecting connectors, or parts may be damaged.

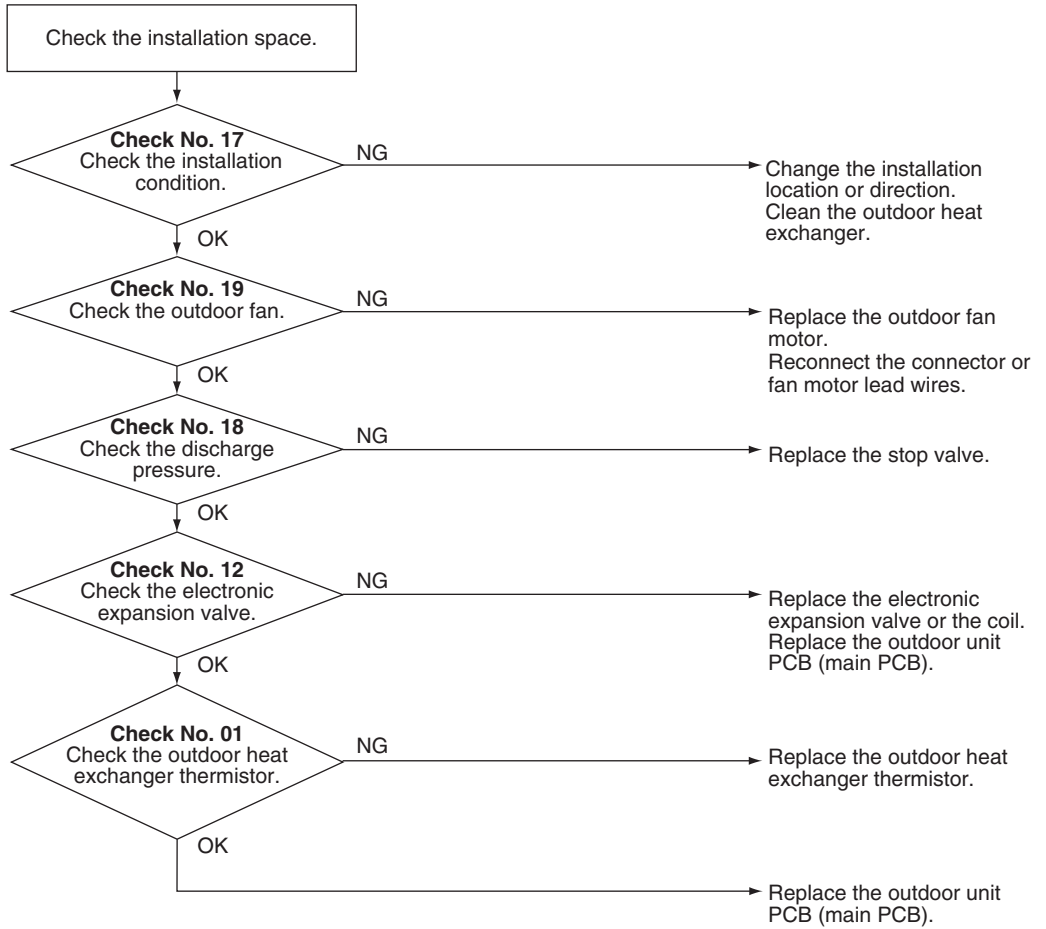

(R20418)



**Reference** Check No.01 Refer to P.188



**Reference** Check No.12 Refer to P.191



**Reference** Check No.17 Refer to P.197



**Reference** Check No.18 Refer to P.197



**Reference** Check No.19 Refer to P.198

# 7.11 System Shutdown due to Temperature Abnormality in the Compressor

<b>Error Code</b>	<b>F8</b>
<b>Method of Error Detection</b>	Operation is halted when the temperature detected by the discharge pipe thermistor exceeds the determined limit.
<b>Error Decision Conditions</b>	Temperature exceeds the detection threshold of 127.5°C (261.5°F) during forced cooling operation.
<b>Supposed Causes</b>	<ul style="list-style-type: none"> <li>■ Abnormal operation due to air intrusion</li> <li>■ Defective discharge pipe thermistor</li> </ul>

**Troubleshooting**

 **Caution** Be sure to turn off the power switch before connecting or disconnecting connectors, or parts may be damaged.

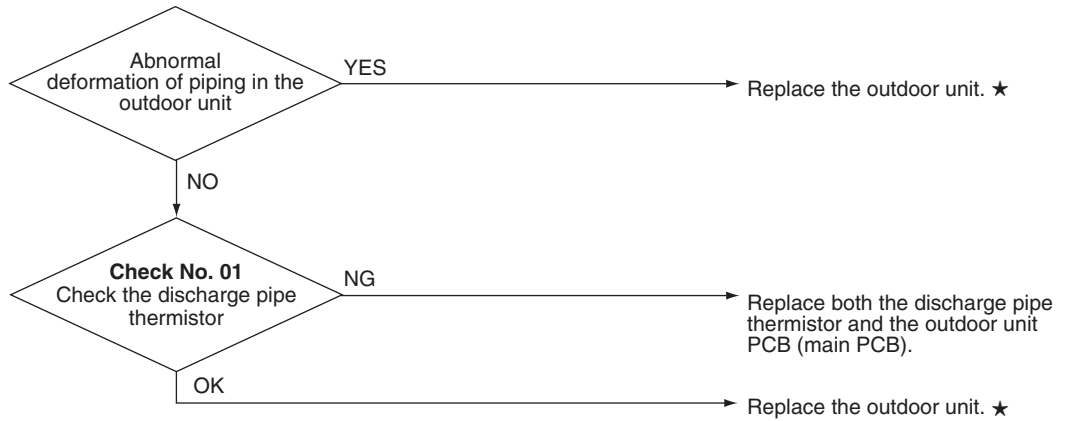

★ Replace the unit as directed in the installation manual, making sure that air does not intrude into the refrigerant piping.

(R23655)



**Reference** Check No.01 Refer to P.188



## 7.12 Compressor Sensor System Abnormality

Error Code

**H0**

Method of Error Detection

The system checks the DC current before the compressor starts.

Error Decision Conditions

- The voltage converted from the DC current before compressor start-up is out of the range 0.5 ~ 4.5 V.
- The DC voltage before compressor start-up is below 50 V.

Supposed Causes

- Broken or disconnected harness
- Defective outdoor unit PCB

Troubleshooting

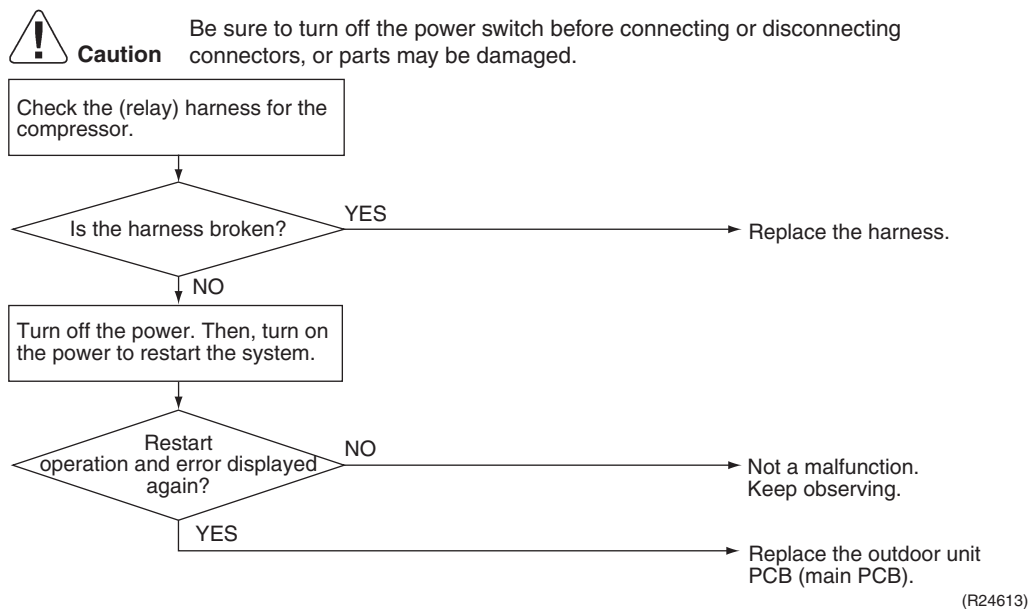

## 7.13 Position Sensor Abnormality

---

<b>Error Code</b>	<b>H6</b>
<b>Method of Error Detection</b>	A compressor start-up failure is detected by checking the compressor running condition through the position detection circuit.
<b>Error Decision Conditions</b>	<ul style="list-style-type: none"><li>■ If the error repeats, the system is shut down.</li><li>■ Reset condition: Continuous run for about 11 minutes without any other error</li></ul>
<b>Supposed Causes</b>	<ul style="list-style-type: none"><li>■ Power supply voltage out of specification</li><li>■ Disconnection of the compressor harness</li><li>■ Defective compressor</li><li>■ Defective outdoor unit PCB</li><li>■ Start-up failure caused by the closed stop valve</li><li>■ Input voltage outside the specified range</li></ul>

Troubleshooting



**Caution** Be sure to turn off the power switch before connecting or disconnecting connectors, or parts may be damaged.

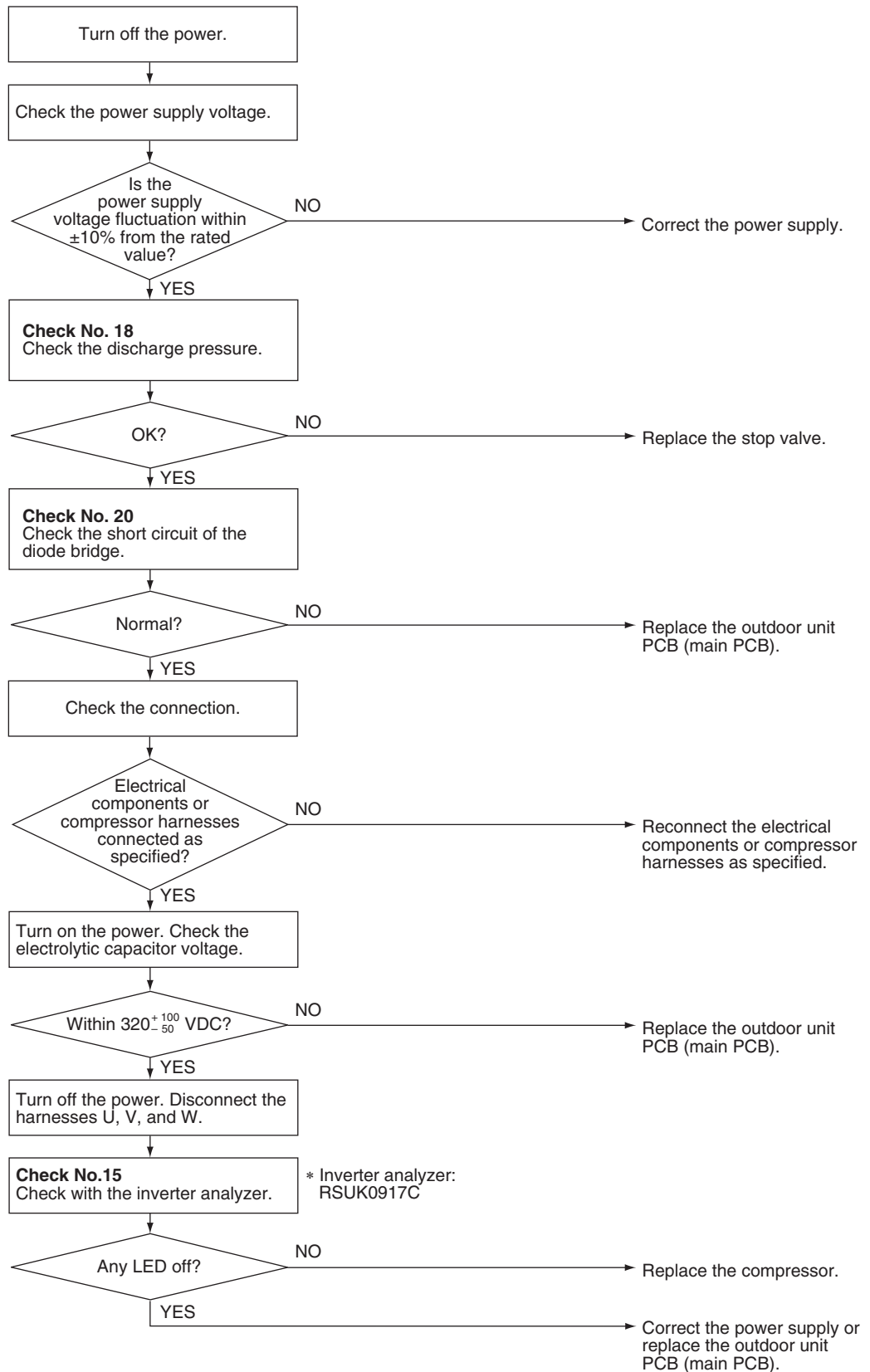

(R22764)

 **Reference**    **Check No.15** Refer to P.193

 **Reference**    **Check No.18** Refer to P.197

 **Reference**    **Check No.20** Refer to P.198

## 7.14 DC Voltage/Current Sensor Abnormality

<b>Error Code</b>	<b>H8</b>
<b>Method of Error Detection</b>	DC voltage or DC current sensor abnormality is identified based on the compressor running frequency and the input current.
<b>Error Decision Conditions</b>	<ul style="list-style-type: none"><li>■ If the error repeats, the system is shut down.</li><li>■ Reset condition: Continuous run for about 60 minutes without any other error</li></ul>
<b>Supposed Causes</b>	<ul style="list-style-type: none"><li>■ Defective outdoor unit PCB</li></ul>
<b>Troubleshooting</b>	

**Caution**

Be sure to turn off the power switch before connecting or disconnecting connectors, or parts may be damaged.

**Replace the outdoor unit PCB (main PCB).**

## 7.15 Thermistor or Related Abnormality (Outdoor Unit)

<b>Error Code</b>	<b>H9, J3, J6, P4</b>
<b>Method of Error Detection</b>	This fault is identified based on the thermistor input voltage to the microcomputer. A thermistor fault is identified based on the temperature sensed by each thermistor.
<b>Error Decision Conditions</b>	<ul style="list-style-type: none"> <li>■ The voltage between the both ends of the thermistor is either 4.96 V or more, or 0.04 V or less with the power on.</li> <li>■ <b>J3</b> error is judged if the discharge pipe temperature is lower than the heat exchanger temperature.</li> </ul>
<b>Supposed Causes</b>	<ul style="list-style-type: none"> <li>■ Disconnection of the connector for the thermistor</li> <li>■ Defective thermistor(s)</li> <li>■ Defective heat exchanger thermistor in the case of <b>J3</b> error (outdoor heat exchanger thermistor in cooling operation, or indoor heat exchanger thermistor in heating operation)</li> <li>■ Defective outdoor unit PCB</li> </ul>
<b>Troubleshooting</b>	<p><b>In case of P4</b></p> <div style="display: flex; align-items: center;">  <div style="margin-left: 10px;"> <p><b>Caution</b> Be sure to turn off the power switch before connecting or disconnecting connectors, or parts may be damaged.</p> </div> </div> <p><b>Replace the outdoor unit PCB (main PCB).</b></p> <p><b>P4</b> : Radiation fin thermistor</p>

**Troubleshooting** In case of H9, J3, J6



**Caution** Be sure to turn off the power switch before connecting or disconnecting connectors, or parts may be damaged.

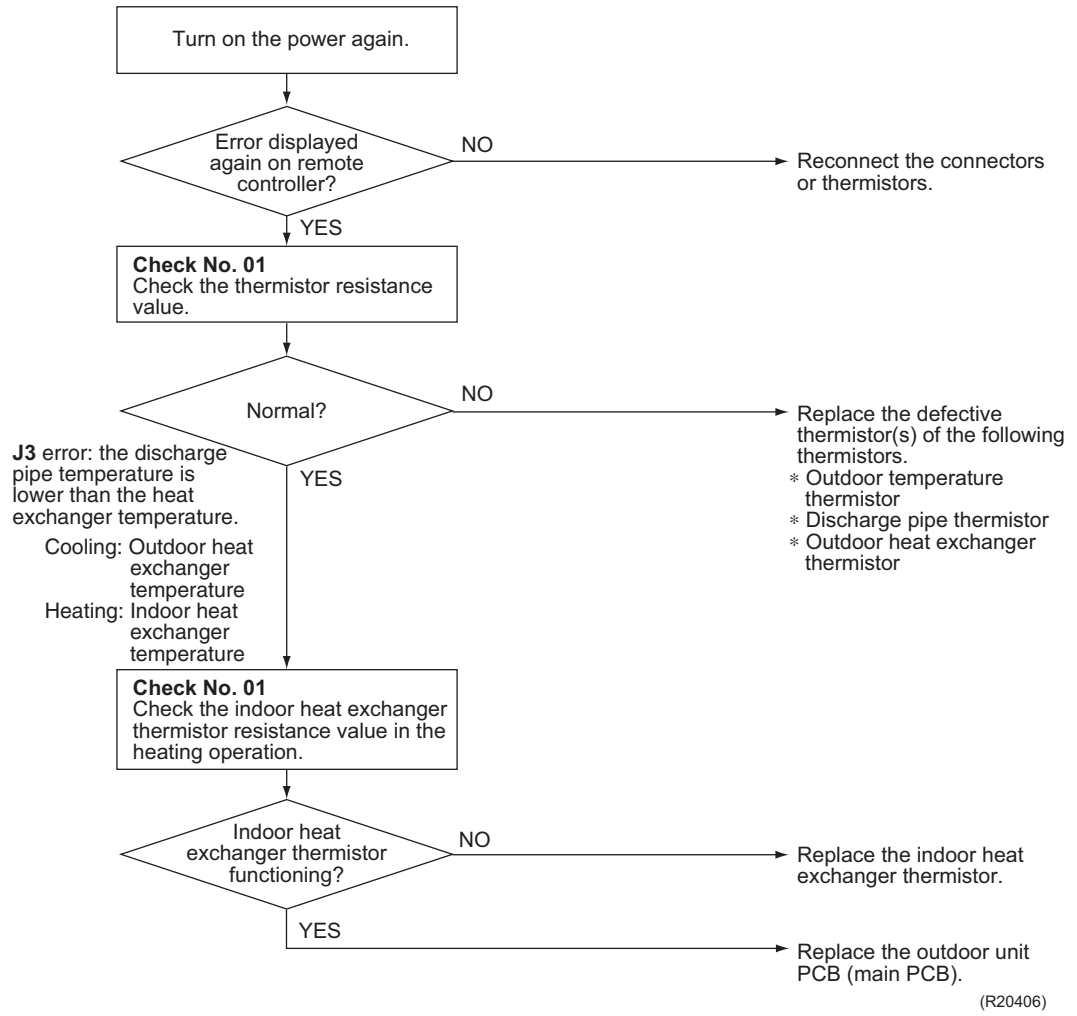

(R20406)

- H9** : Outdoor temperature thermistor
- J3** : Discharge pipe thermistor
- J6** : Outdoor heat exchanger thermistor



**Reference**

**Check No.01** Refer to P.188

# 7.16 Electrical Box Temperature Rise

**Error Code** **L3**

**Method of Error Detection** An electrical box temperature rise is detected by checking the radiation fin thermistor with the compressor off.

- Error Decision Conditions**
- With the compressor off, the radiation fin temperature is above **A**.
  - The error is cleared when the radiation fin temperature drops below **B**.
  - To cool the electrical components, the outdoor fan starts when the radiation fin temperature rises above **C** and stops when the radiation fin temperature drops below **B**.

	<b>A</b>		<b>B</b>		<b>C</b>	
	°C	°F	°C	°F	°C	°F
09/12 class	82	179.6	65	149	70	158
15/18/24 class	90	194	64	147.2	81	177.8

- Supposed Causes**
- Defective outdoor fan motor
  - Short circuit
  - Defective radiation fin thermistor
  - Disconnection of connector
  - Defective outdoor unit PCB

**Troubleshooting**

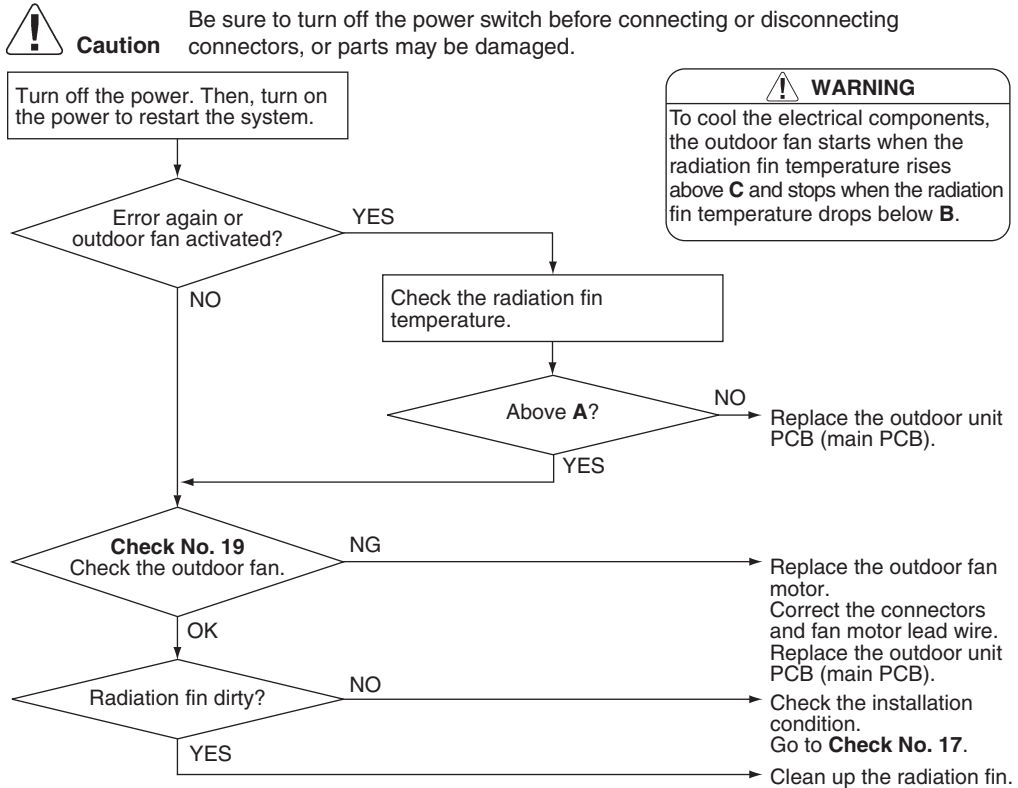

(R22998)

**Reference** **Check No.17** Refer to P.197

**Reference** **Check No.19** Refer to P.198



## 7.17 Radiation Fin Temperature Rise

### Error Code

# L4

### Method of Error Detection

A radiation fin temperature rise is detected by checking the radiation fin thermistor with the compressor on.

### Error Decision Conditions

- If the radiation fin temperature with the compressor on is above **A**.
- The error is cleared when the radiation fin temperature drops below **B**.
- If the error repeats, the system is shut down.
- Reset condition: Continuous run for about 60 minutes without any other error

	A		B	
	°C	°F	°C	°F
09/12 class	99	210.2	70	158
15/18/24 class	100	212	57	134.6

### Supposed Causes

- Defective outdoor fan motor
- Short circuit
- Defective radiation fin thermistor
- Disconnection of connector
- Defective outdoor unit PCB
- Silicone grease not applied properly on the radiation fin after replacing the outdoor unit PCB

Troubleshooting



**Caution** Be sure to turn off the power switch before connecting or disconnecting connectors, or parts may be damaged.

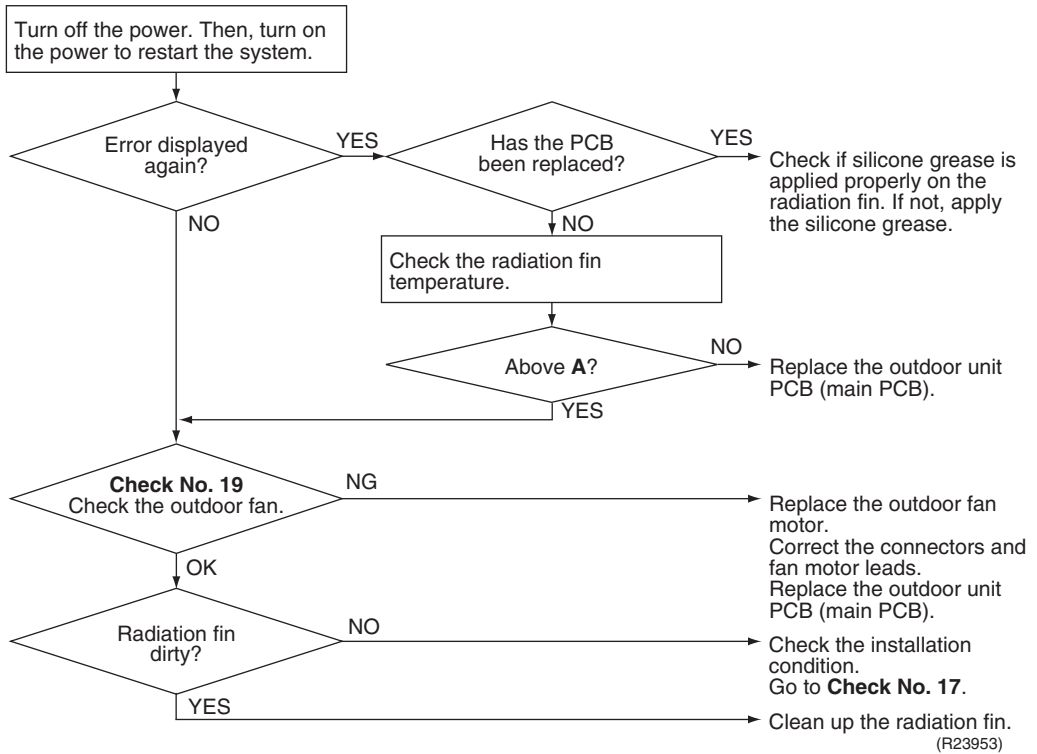

**Reference** Check No.17 Refer to P.197



**Reference** Check No.19 Refer to P.198



**Note** Refer to Silicone Grease on Power Transistor/Diode Bridge on page 227 for details.

## 7.18 Output Overcurrent Detection

---

<b>Error Code</b>	<b>L5</b>
<b>Method of Error Detection</b>	An output overcurrent is detected by checking the current that flows in the inverter DC section.
<b>Error Decision Conditions</b>	<ul style="list-style-type: none"><li>■ A position signal error occurs while the compressor is running.</li><li>■ A rotation speed error occurs while the compressor is running.</li><li>■ An output overcurrent signal is fed from the output overcurrent detection circuit to the microcomputer.</li><li>■ If the error repeats, the system is shut down.</li><li>■ Reset condition: Continuous run for about 11 minutes without any other error</li></ul>
<b>Supposed Causes</b>	<ul style="list-style-type: none"><li>■ Poor installation condition</li><li>■ Closed stop valve</li><li>■ Defective power module</li><li>■ Wrong internal wiring</li><li>■ Abnormal power supply voltage</li><li>■ Defective outdoor unit PCB</li><li>■ Power supply voltage out of specification</li><li>■ Defective compressor</li></ul>

Troubleshooting





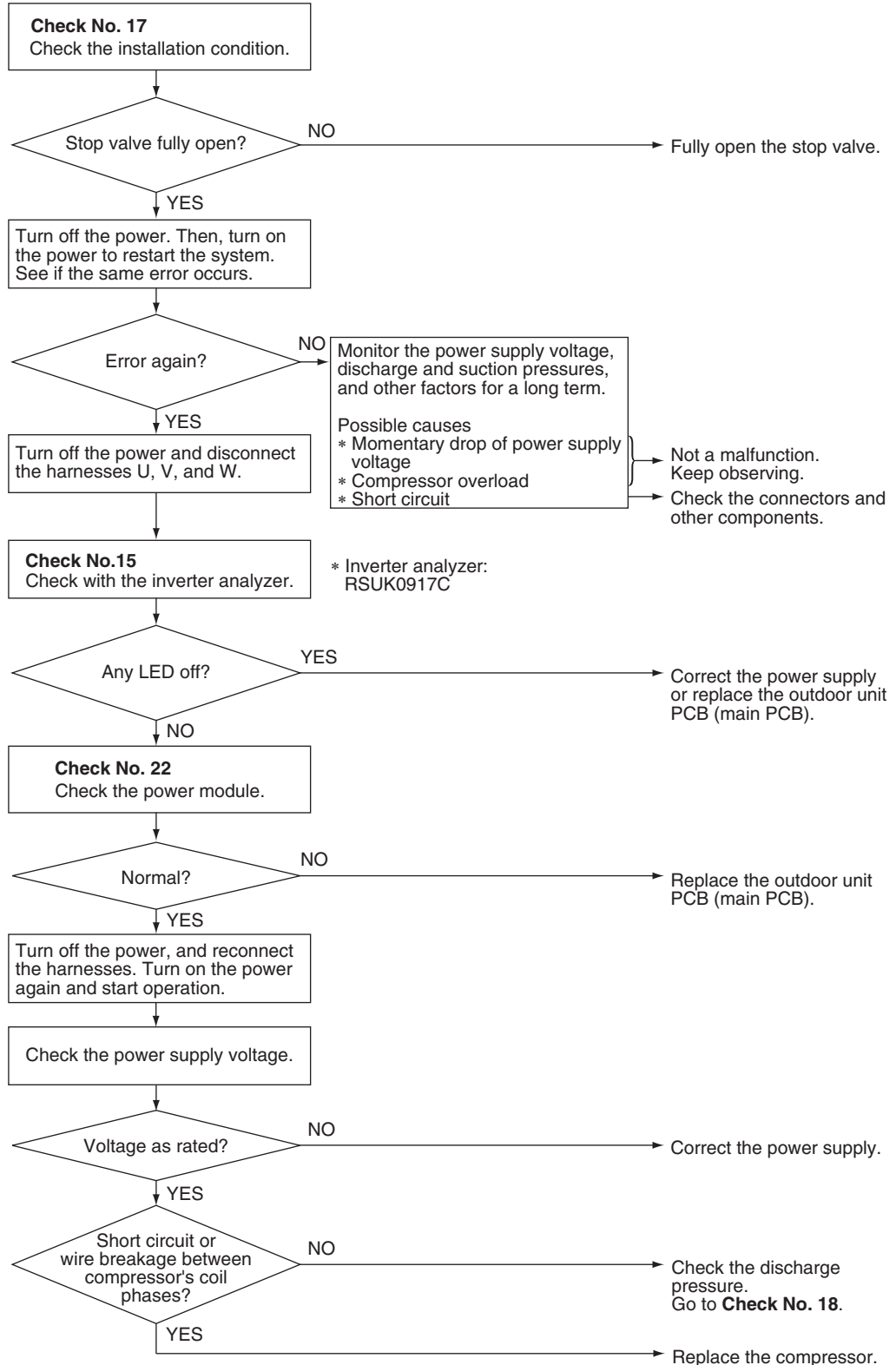

**Caution** Be sure to turn off the power switch before connecting or disconnecting connectors, or parts may be damaged.

\* An output overcurrent may result from wrong internal wiring. If the system is interrupted by an output overcurrent after the wires have been disconnected and reconnected for part replacement, check the wiring again.



(R21438)

-  **Reference**    **Check No.15** Refer to P.193
-  **Reference**    **Check No.17** Refer to P.197
-  **Reference**    **Check No.18** Refer to P.197
-  **Reference**    **Check No.22** Refer to P.200

# 8. Check

## 8.1 Thermistor Resistance Check

### Check No.01

Measure the resistance of each thermistor using multimeter.

The resistance values are defined by below table.

If the measured resistance value does not match the listed value, the thermistor must be replaced.

- Disconnect the connector of thermistor ASSY from the PCB to measure the resistance between the pins using multimeter.
- To check the thermistor soldered on a PCB, disconnect the PCB from other PCB/parts, and measure the resistance between the both ends of soldered thermistor.

Thermistor ASSY

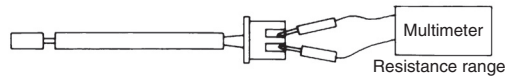

Soldered thermistor

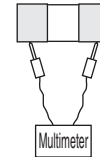

R6000517

Thermistor temperature		Type A R (25°C (77°F)) = 20 kΩ B = 3950 K
(°C)	(°F)	
-20	-4	197.8
-15	5	148.2
-10	14	112.1
-5	23	85.60
0	32	65.93
5	41	51.14
10	50	39.99
15	59	31.52
20	68	25.02
25	77	20.00
30	86	16.10
35	95	13.04
40	104	10.62
45	113	8.707
50	122	7.176

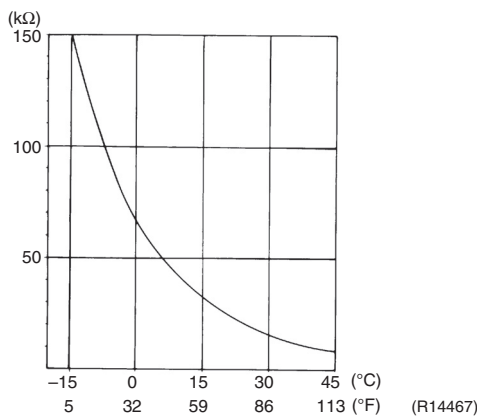

**Note(s)**

When replacing the defective thermistor(s), replace the thermistor as ASSY.

## 8.2 Indoor Fan Motor Connector Check

**Check No.02**

**FTXR Series**

1. Check the connection of connector.
2. Check motor power supply voltage output (pins 4 - 7).
3. Check motor control voltage (pins 4 - 3).
4. Check rotation command voltage output (pins 4 - 2).
5. Check rotation pulse input (pins 4 - 1).

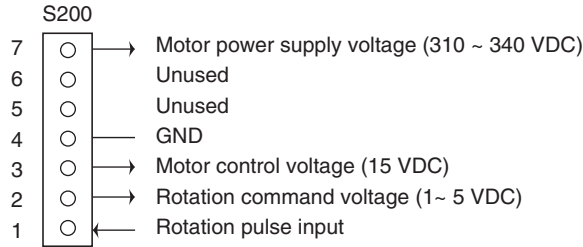

R6000588

**FDMQ Series**

1. Turn the power supply OFF.
2. With the fan motor connector disconnected, measure the resistance between each pin, then make sure that the resistance is more than the value mentioned in the following table.

Measuring points	Judgement
White - Blue	1 MΩ or more
Orange - Blue	100 kΩ or more
Brown - Blue	100 Ω or more
Red - Blue	100 kΩ or more

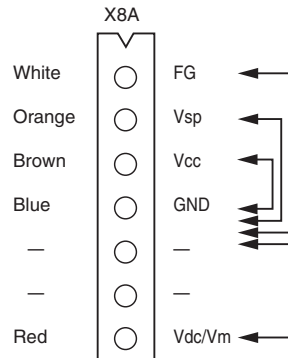

(R25080)

**FFQ Series**

1. Check the connection of connector.
2. Check motor power supply voltage output (pins 5 - 8).
3. Check motor control voltage (pins 5 - 4).
4. Check rotation command voltage output (pins 5 - 3).

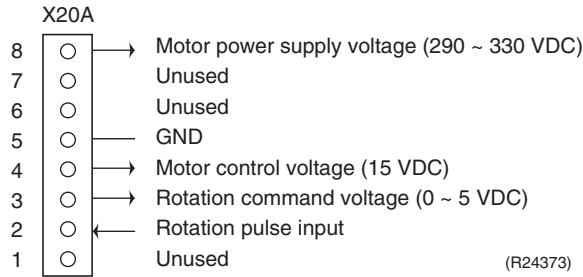

## 8.3 Power Supply Waveform Check

**Check No.11**

Measure the power supply waveform between No. 1 and No. 2 on the terminal strip, and check the waveform disturbance.

- Check if the power supply waveform is a sine wave (Fig.1).
- Check if there is waveform disturbance near the zero-cross (sections circled in Fig.2).

[Fig.1]

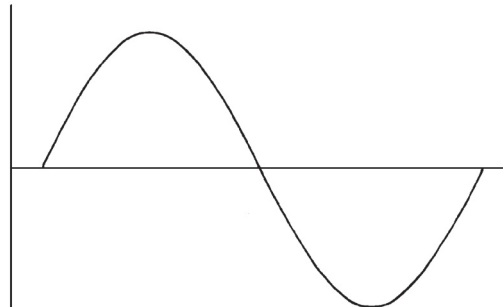

(R1736)

[Fig.2]

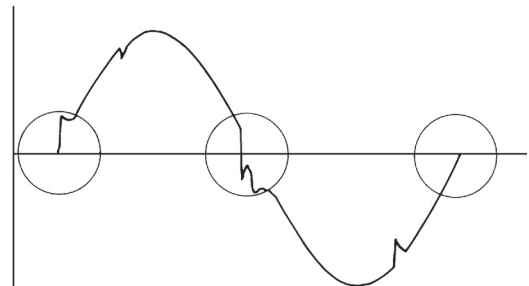

(R1444)



## 8.4 Electronic Expansion Valve Check

### Check No.12

Conduct the following to check the electronic expansion valve (EV).

1. Check if the EV connector is correctly connected to the PCB.
2. Turn the power off and on again, and check if the EV generates a latching sound.
3. If the EV does not generate a latching sound in step 2, disconnect the connector and check the continuity using a multimeter.
4. Check the continuity between the pins 5 - 1, 5 - 2, 5 - 3, 5 - 4 (between the pins 6 - 1, 6 - 2, 6 - 3, and 6 - 4 for the 6P connector models). If there is no continuity between the pins, the EV coil is faulty.
5. If the continuity is confirmed in step 3, the outdoor unit PCB (main PCB) is faulty.

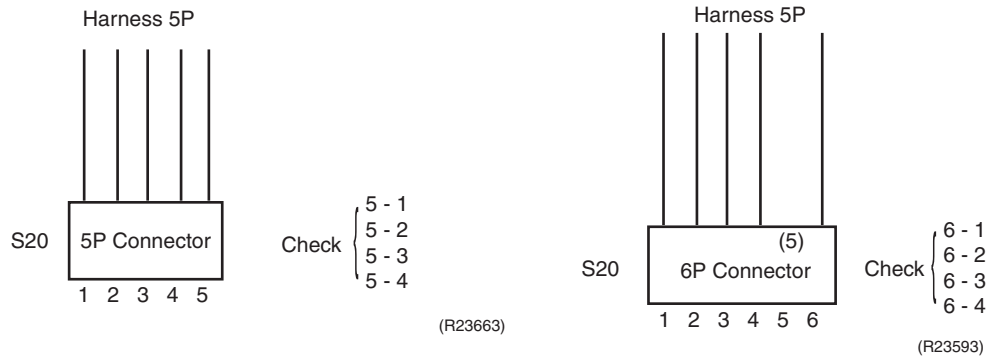

## 8.5 Four Way Valve Performance Check

### Check No.13

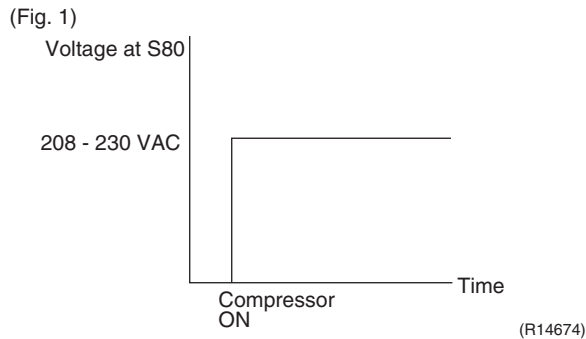
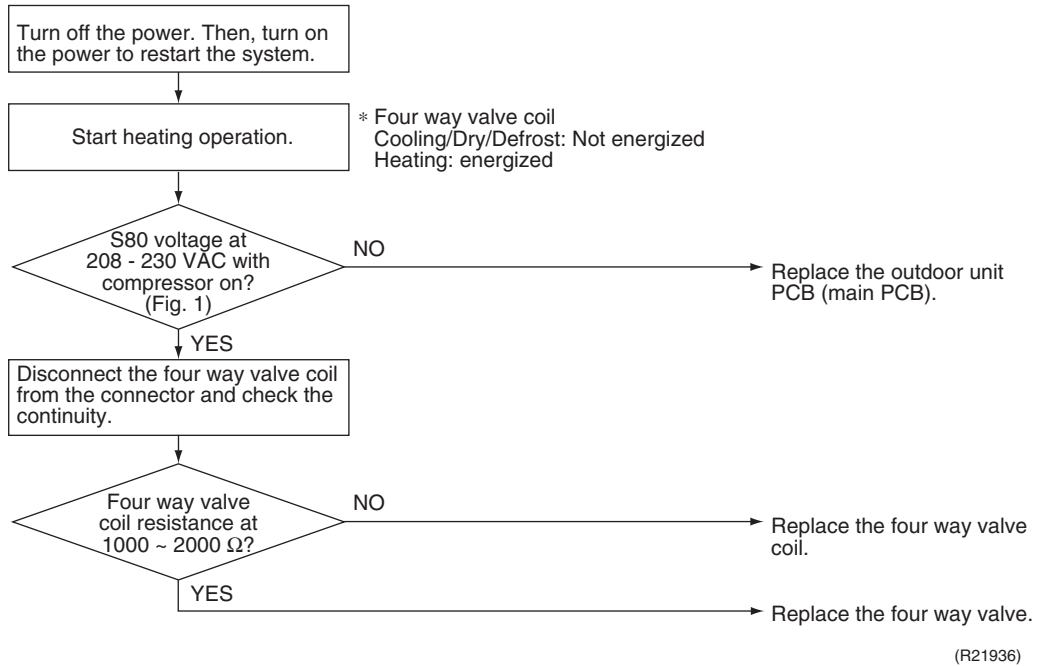

## 8.6 Inverter Unit Refrigerant System Check

### Check No.14

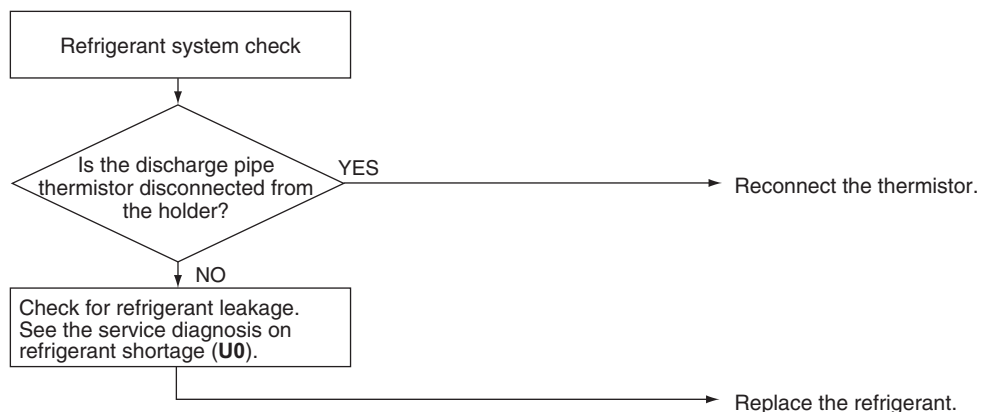

## 8.7 Inverter Analyzer Check

### Check No.15

#### ■ Characteristics

Inverter analyzer: RSUK0917C

If an abnormal stop occurs due to compressor startup failure or overcurrent output when using an inverter unit, it is difficult to judge whether the stop is caused by the compressor failure or some other failure (main PCB, power module, etc.). The inverter analyzer makes it possible to judge the cause of trouble easily and securely. Connect an inverter analyzer as a quasi-compressor instead of compressor and check the output of the inverter.

#### ■ Operation Method

##### Step 1

Be sure to turn the power off.

##### Step 2

Install an inverter analyzer instead of a compressor.

Note:

Make sure the charged voltage of the built-in smoothing electrolytic capacitor drops to 10 VDC or below before carrying out the service work.

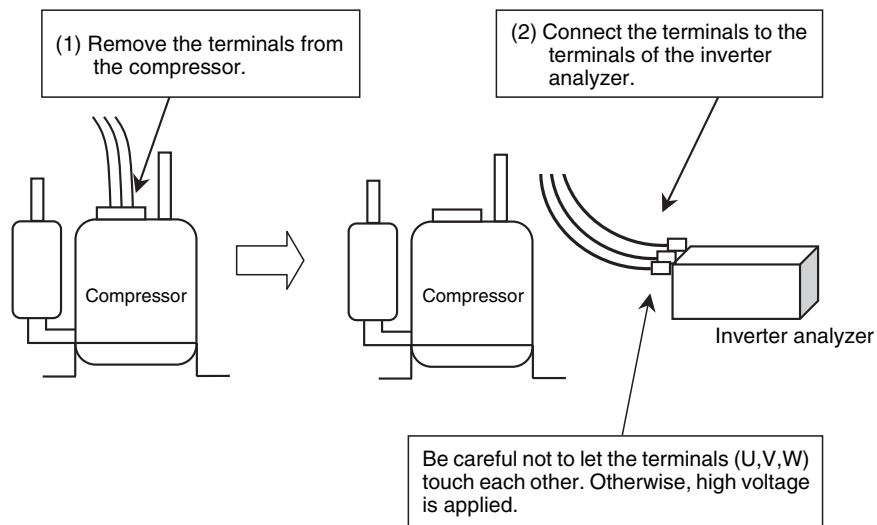

R6000682

Reference:

If the terminals of the compressor are not FASTON terminals (difficult to remove the wire on the terminals), it is possible to connect wires available on site to the outdoor unit from output side of PCB. Do not connect them to the compressor at the same time, otherwise it may result in incorrect detection.

##### Step 3

Activate the power transistor test operation from the outdoor unit.



#### Note

Power transistor test operation can be activated only once after turning on the power supply. If reactivation of the power supply transistor operation is needed, turn the power supply off and then on again.

**FTXR Series**

1. Turn the power on.
2. Select FAN operation with the **Mode** button on the remote controller.
3. Press the center of the **Temp** button and the **Mode** button at the same time.
4. Select **T** with the **Temp▲** or **Temp▼** button.
5. Press the **Mode** button to start the power transistor test operation.

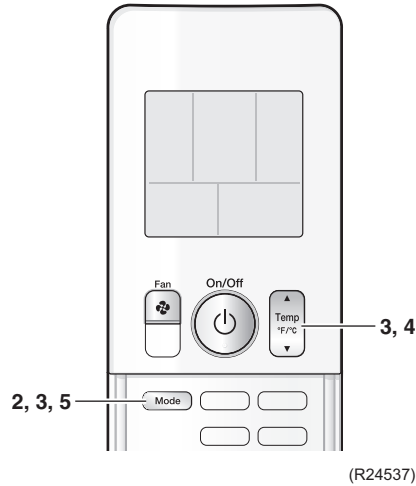

**FDMQ, FFQ Series with Wired Remote Controller (BRC1E73)**

1. Turn the power on.
  2. Set FAN operation using the remote controller.
  3. Press and hold **Cancel** button for 4 seconds or longer.
  4. Select **Test Operation** in the service settings menu, then press **Menu/OK** button.  
→ Basic screen returns and “Test Operation” is displayed at the bottom.
  5. Press **On/Off** button within 10 seconds.  
→ 3 minutes after pressing **On/Off** button, power transistor test operation will start.
- Test operation will stop automatically after about 30 minutes.  
To stop the operation, press **On/Off** button.

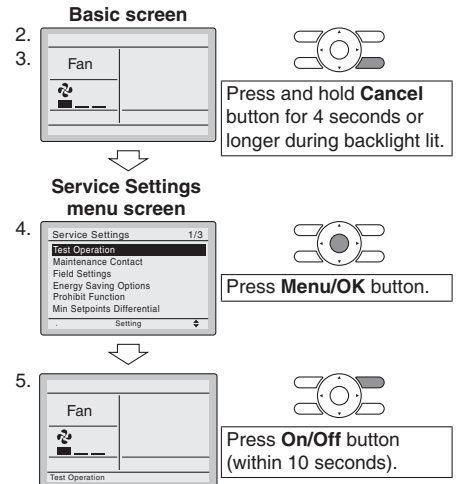

**FDMQ, FFQ Series with Wireless Remote Controller (BRC082A43, BRC082A41W, BRC082A42W(S))**

1. Turn the power on.
  2. Press and select FAN operation.
  3. Press twice. “TEST” is displayed.
  4. Press within 10 seconds.  
→ 3 minutes after pressing , power transistor test operation will start.
- Test operation will stop automatically after about 30 minutes.  
To stop the operation, press .

■ **Diagnose method (Diagnose according to 6 LEDs lighting status.)**

1. If all the LEDs are lit uniformly, the compressor is defective.  
→ Replace the compressor.
2. If the LEDs are not lit uniformly, check the power module.  
→ Refer to **Check No.22**.
3. If NG in **Check No.22**, replace the power module.  
(Replace the main PCB. The power module (IPM1) is united with the main PCB.)  
If OK in **Check No.22**, check if there is any solder cracking on the PCB.
4. If any solder cracking is found, replace the PCB or repair the soldered section.  
If there is no solder cracking, replace the PCB.



**Caution**

1. When the output frequency is low, the LEDs blink slowly. As the output frequency increases, the LEDs blink quicker. (The LEDs look like they are lit.)
2. On completion of the inverter analyzer diagnosis, be sure to re-crimp the FASTON terminals. Otherwise, the terminals may be burned due to loosening.

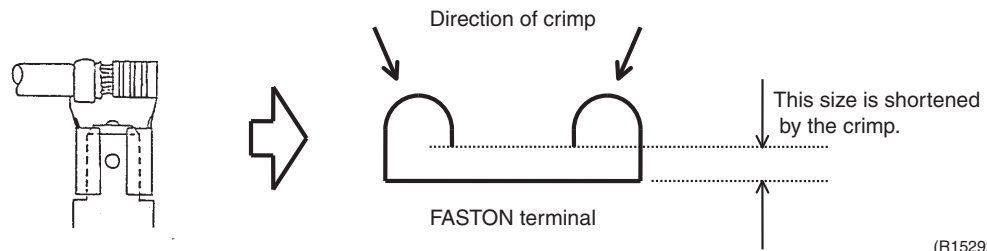

## 8.8 Outdoor Fan Motor Check

### Check No.16

Make sure that the voltage is within  $320^{+100}_{-50}$  VDC.

1. Set operation off and power off. Disconnect the connector S70 or S71.
2. Check that the voltage between the pins 4 - 7 is 320 VDC.
3. Check that the control voltage between the pins 4 - 3 is 15 VDC.
4. Check that the rotation command voltage between the pins 4 - 2 is 0 ~ 6.5 VDC.
5. Keep operation off and power off. Connect the connector S70 or S71.
6. Check whether 4 rotation pulses (0 ~ 15 VDC) are input at the pins 4 - 1 when the fan motor is rotated 1 turn by hand.

When the fuse is melted, check the outdoor fan motor for proper function.

If NG in step 2 → Defective PCB → Replace the outdoor unit PCB (main PCB).

If NG in step 4 → Defective Hall IC → Replace the outdoor fan motor.

If OK in both steps 2 and 4 → Replace the outdoor unit PCB (main PCB).

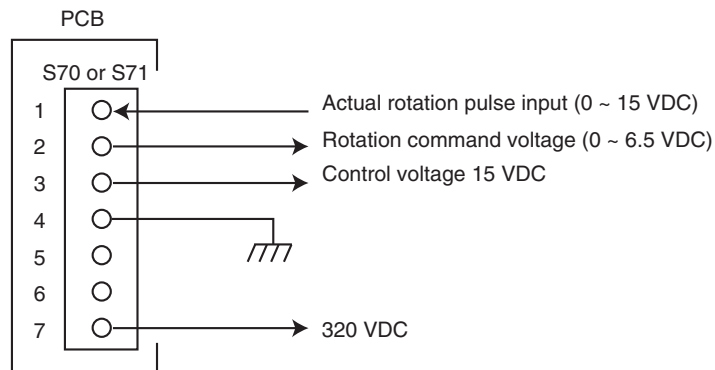

(R20507)

## 8.9 Installation Condition Check

### Check No.17

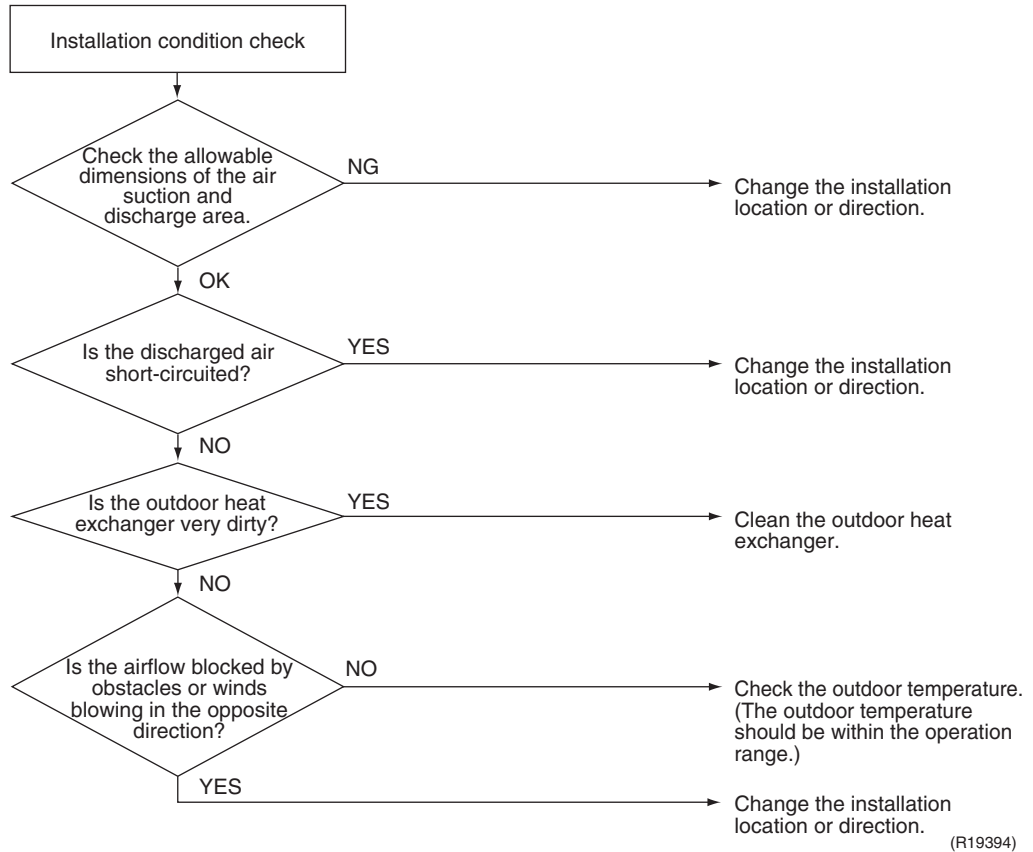

## 8.10 Discharge Pressure Check

### Check No.18

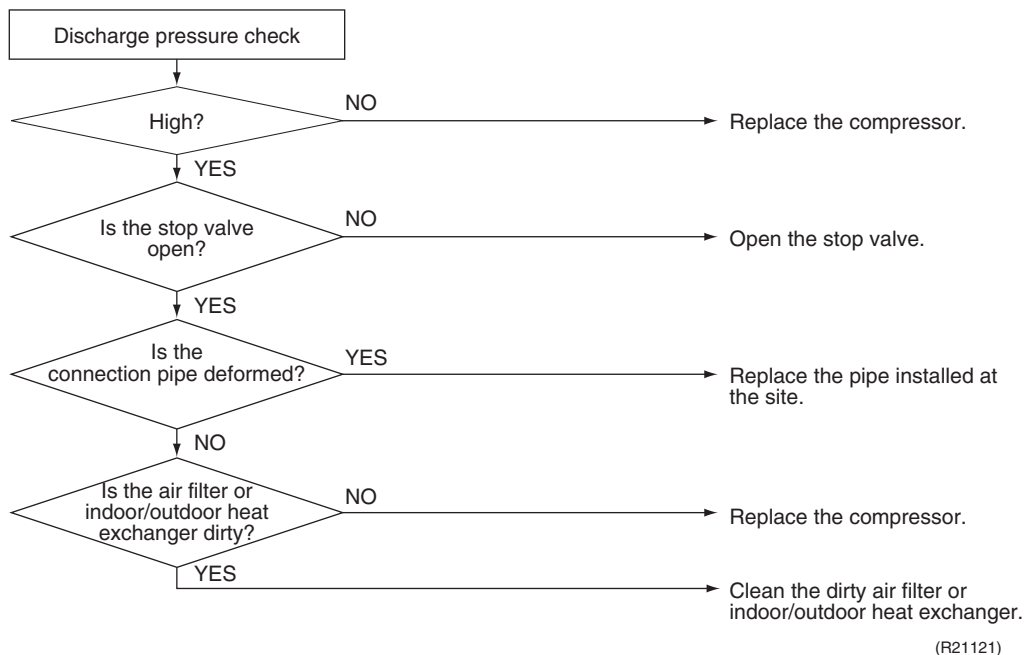

# 8.11 Outdoor Fan System Check

Check No.19

DC motor

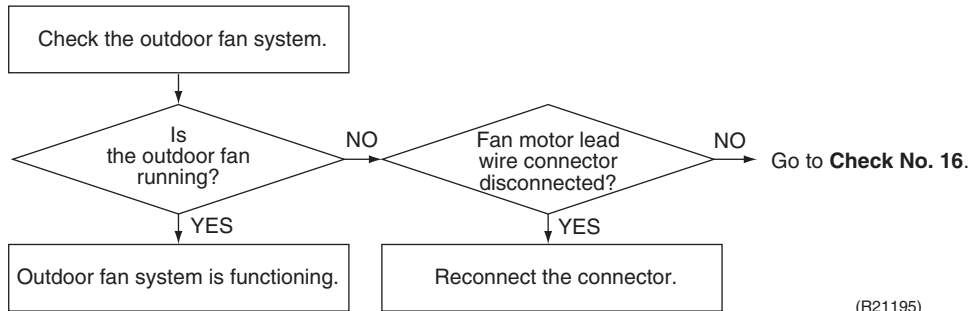

(R21195)

# 8.12 Main Circuit Short Check

Check No.20

Check to make sure that the voltage between (+) and (-) of the diode bridge (DB1) is about 0 V before checking

- Measure the resistance between the pins of the DB1 referring to the table below.
- If the resistance is  $\infty$  or less than 1 k $\Omega$ , short circuit occurs on the main circuit.

Positive terminal (+) of digital multimeter	~ (2, 3)	+ (4)	~ (2, 3)	- (1)
Negative terminal (-) of digital multimeter	+ (4)	~ (2, 3)	- (1)	~ (2, 3)
Resistance is OK.	several k $\Omega$ ~ several M $\Omega$			
Resistance is NG.	0 $\Omega$ or $\infty$			

09/12 class

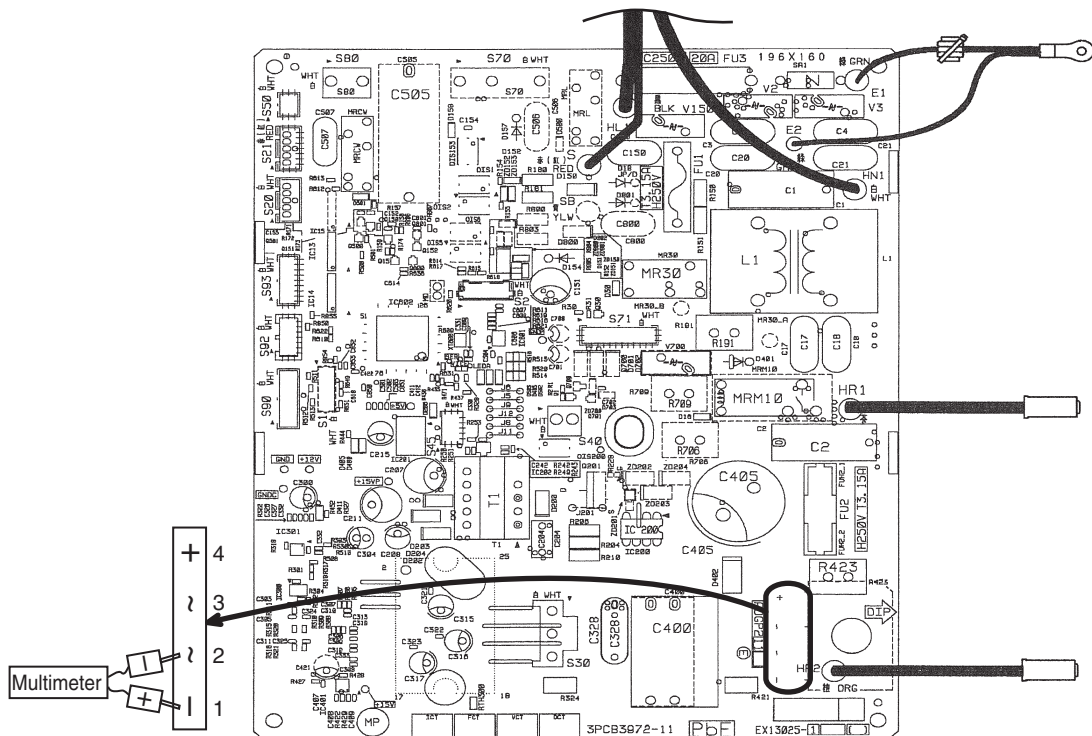

(R20698)



15/18/24 class

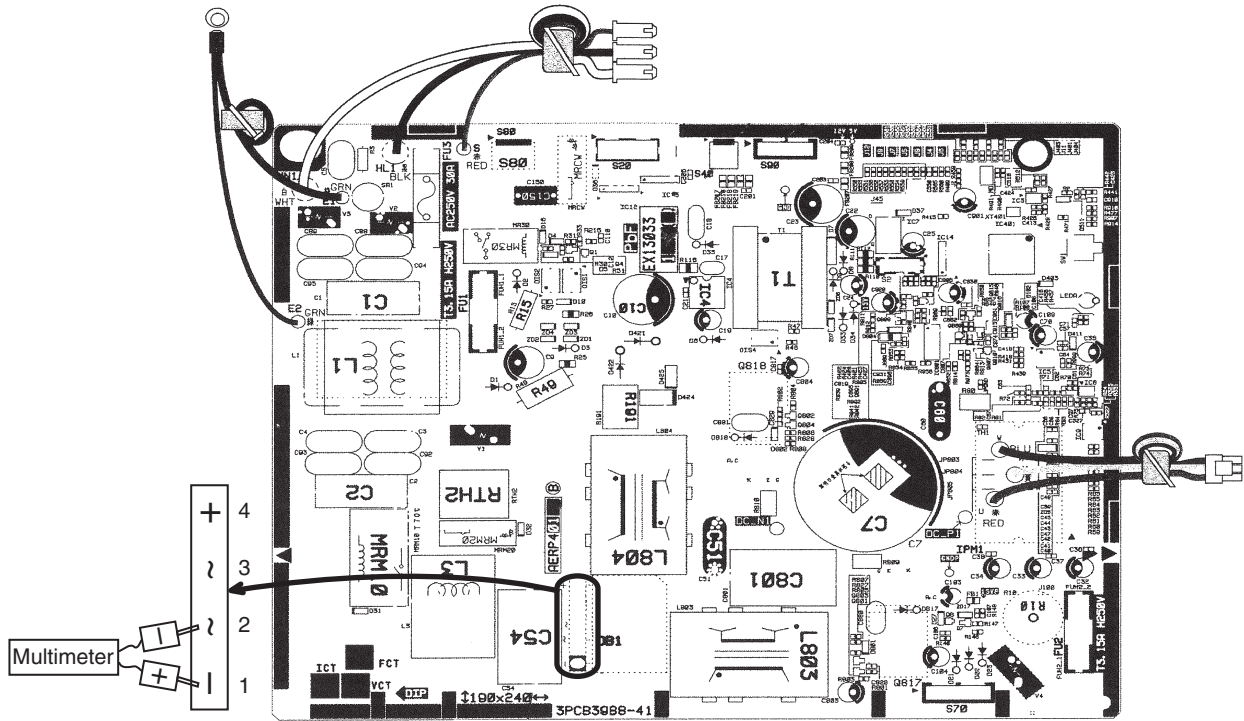

(R25105)

# 8.13 Power Module Check

## Check No.22

Check to make sure that the voltage between (+) and (-) of the power module is about 0 V before checking.

- Disconnect the compressor harness connector from the outdoor unit PCB. To disengage the connector, press the protrusion on the connector.
- Follow the procedure below to measure resistance between the terminals of the power module and the terminals of the compressor with a multimeter. Evaluate the measurement results referring to the following table.

Positive terminal (+) of digital multimeter	Power module (+)	UVW	Power module (-)	UVW
Negative terminal (-) of digital multimeter	UVW	Power module (+)	UVW	Power module (-)
Resistance is OK.	several kΩ ~ several MΩ			
Resistance is NG.	0 Ω or ∞			

09/12 class

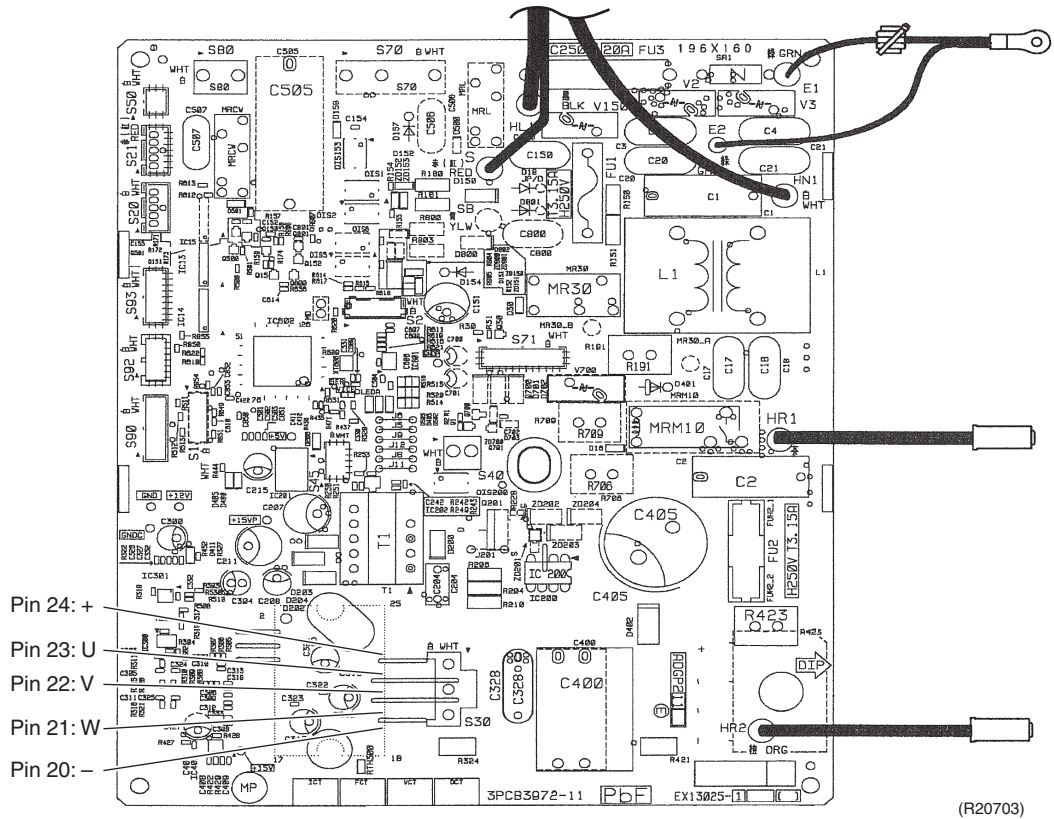

15/18/24 class

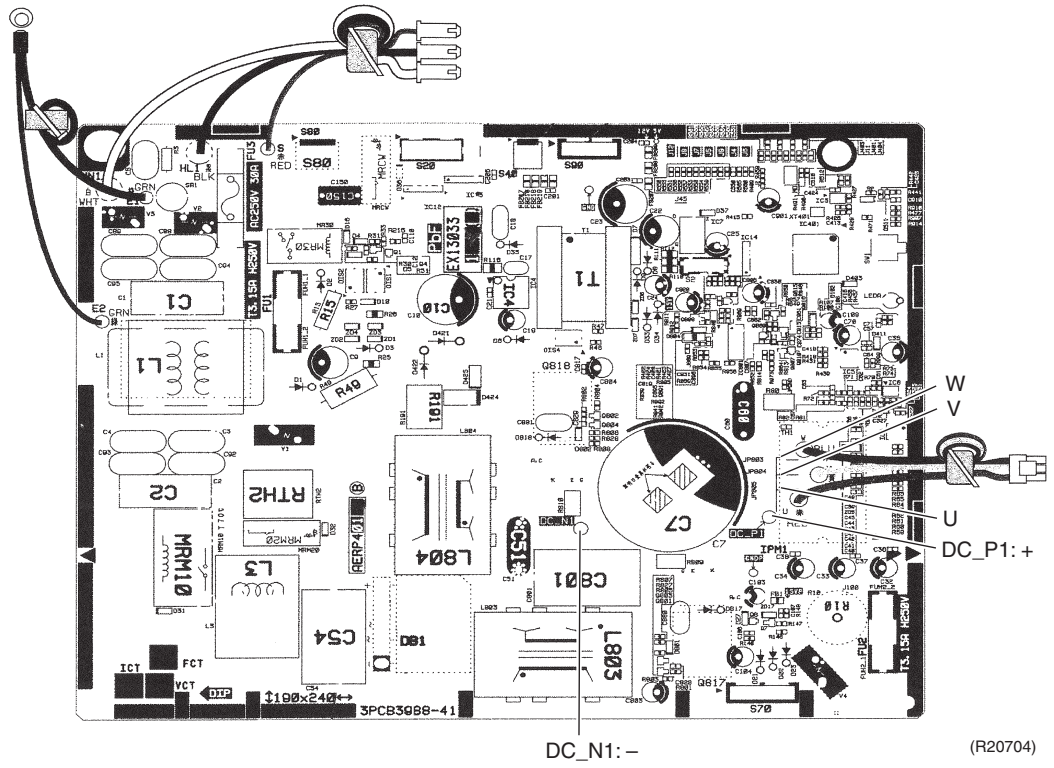

---

# Part 7

## Trial Operation and Field Settings

1. Pump Down Operation .....	203
2. Forced Cooling Operation .....	204
3. Trial Operation .....	206
3.1 FTXR Series .....	206
3.2 FDMQ, FFQ Series .....	207
4. Field Settings for FTXR Series .....	210
4.1 Temperature Display Switch .....	210
4.2 When 2 Units are Installed in 1 Room .....	210
4.3 Jumper and Switch Settings .....	211
5. Field Settings for FDMQ, FFQ Series .....	212
5.1 How to Change the Field Settings .....	212
5.2 Overview of Field Settings for FDMQ Series .....	215
5.3 Overview of Field Settings for FFQ Series .....	216
5.4 MAIN/SUB Setting when Using 2 Wired Remote Controllers .....	217
5.5 MAIN/SUB and Address Setting for Wireless Remote Controller for FDMQ Series .....	218
5.6 MAIN/SUB and Address Setting for Wireless Remote Controller for FFQ Series .....	221
6. Field Settings for Outdoor Unit .....	224
6.1 Facility Setting (cooling at low outdoor temperature) .....	224
6.2 Warmer Airflow Setting .....	225
6.3 Drain Pan Heater .....	226
7. Silicone Grease on Power Transistor/Diode Bridge .....	227

# 1. Pump Down Operation

## Outline

In order to protect the environment, be sure to conduct pump down operation when relocating or disposing of the unit.

## Details

1. Remove the valve caps from the liquid stop valve and the gas stop valve.
2. Carry out forced cooling operation.
3. After 5 to 10 minutes, close the liquid stop valve with a hexagonal wrench.
4. After 2 to 3 minutes, close the gas stop valve and stop the forced cooling operation.
5. Attach the valve cap once procedures are complete.

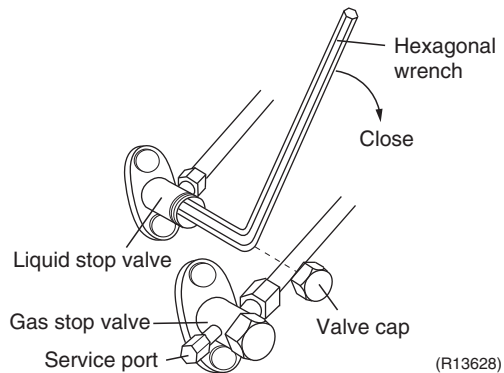

## Reference

Refer to Forced Cooling Operation on page 204 for details.

## 2. Forced Cooling Operation

### Outline

The forced cooling operation is allowed when both the following conditions are met.

1. The outdoor unit is not abnormal and not in the 3-minute standby mode.
2. The outdoor unit is not operating.

Protection functions have priority over all other functions during forced cooling operation.

### Details

#### FTXR Series

##### ■ With indoor unit ON/OFF switch

Press indoor unit **ON/OFF** switch for at least 5 seconds. The operation will start.

Forced cooling operation will stop automatically after about 15 minutes.

To stop the operation, press indoor unit **ON/OFF** switch.

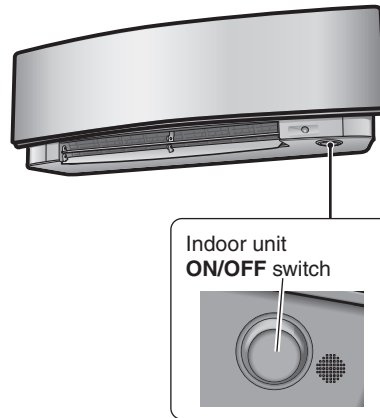

R7000226

##### ■ With the indoor unit's remote controller

1. Press **Temp▲, ▼** buttons and **Mode** button at the same time.
2. Press **Temp▲, ▼** buttons, select "T", and press **Mode** button for confirmation.
3. Press **Mode** button and select the cooling operation.
4. Press **On/Off** button to turn on the system.

Forced cooling operation will stop automatically after about 30 minutes.

To stop the operation, press **On/Off** button.

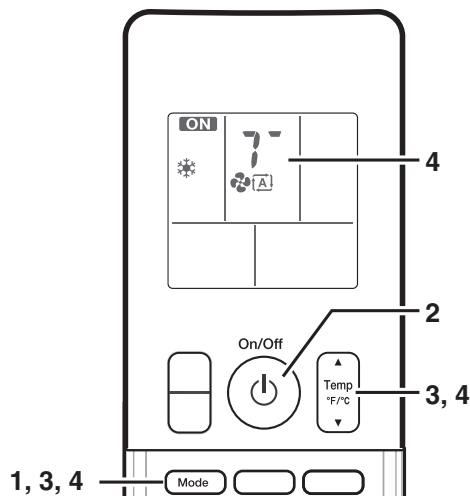

R7000227

### FDMQ, FFQ Series

#### ■ With Wired Remote Controller (BRC1E73)

1. Set to COOL operation using the remote controller.
2. Press and hold **Cancel** button for 4 seconds or longer. Service settings menu is displayed.
3. Select **Test Operation** in the service settings menu, and press **Menu/OK** button. Basic screen returns and “Test Operation” is displayed at the bottom.
4. Press **On/Off** button within 10 seconds, and the forced cooling operation starts.
  - ◆ Forced cooling operation will stop automatically after about 15 minutes. To stop the operation, press **On/Off** button.

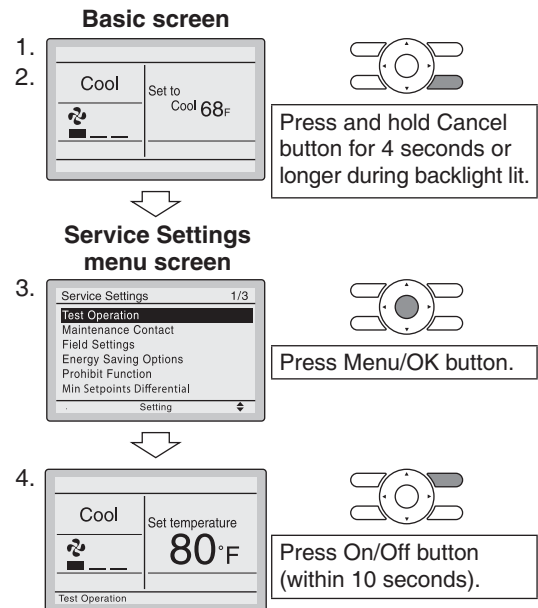

#### ■ With Wireless Remote Controller (BRC082A43, BRC082A41W, BRC082A42W(S))

1. Press **MODE** button and select the COOL operation.
2. Press **TEST** button twice. “TEST” is displayed.
3. Press **ON/OFF** button within 10 seconds, and the forced cooling operation starts.
  - ◆ Forced cooling operation will stop automatically after about 15 minutes. To stop the operation, press **ON/OFF** button.

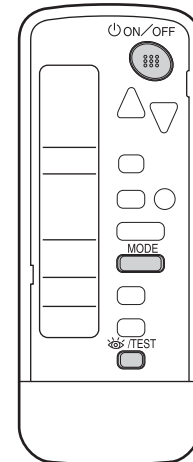

R7000383

# 3. Trial Operation

## 3.1 FTXR Series

### Outline

Trial operation should be carried out in either cooling or heating operation.

1. Measure the supply voltage and make sure that it is within the specified range.
2. In cooling operation, select the lowest programmable temperature; in heating operation, select the highest programmable temperature.
3. Carry out the trial operation following the instructions in the operation manual to ensure that all functions and parts, such as the movement of the louvers, are working properly.
  - To protect the air conditioner, restart operation is disabled for 3 minutes after the system has been turned off.
4. After trial operation is complete, set the temperature to a normal level (78°F to 82°F (26°C to 28°C) in cooling operation, 68°F to 75°F (20°C to 24°C) in heating operation).

When operating the air conditioner in cooling operation in winter, or heating operation in summer, set it to the trial operation mode using the following method.

### Procedure

#### ARC466 Series

1. Press the center of **Temp** button and **Mode** button at the same time.
2. Select **T** (trial operation) with **Temp ▲** or **Temp ▼** button and press **Mode** button for confirmation.
3. Press **On/Off** button to turn on the system.
  - Trial operation will stop automatically after about 30 minutes. To quit trial operation, press **On/Off** button.
  - Some of the functions cannot be used in the trial operation mode.

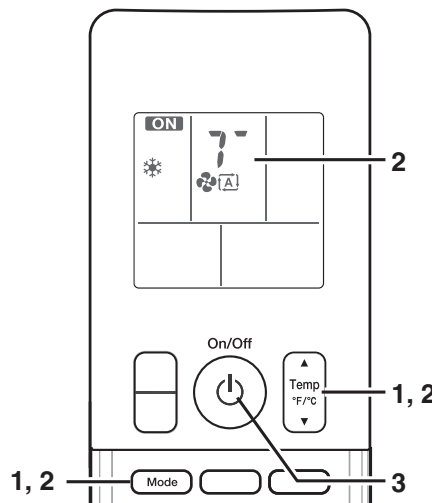

R7000370



## Test Items

Test items	Symptom
Indoor and outdoor units are installed securely.	Fall, vibration, noise
No refrigerant gas leaks.	Incomplete cooling/heating function
Refrigerant gas and liquid pipes and indoor drain hose extension are thermally insulated.	Water leakage
Draining line is properly installed.	Water leakage
System is properly grounded.	Electrical leakage
Only specified wires are used for all wiring, and all wires are connected correctly.	No operation or burn damage
Indoor or outdoor unit's air inlet or air outlet.	Incomplete cooling/heating function
Stop valves are opened.	Incomplete cooling/heating function
Indoor unit properly receives remote controller commands.	No operation
☀ will be displayed when the <b>Mode</b> button is pressed.*	No heating
Pipes and wires are connected to the corresponding terminal blocks / connection ports for the connected unit.	No cooling/heating



## Note(s)

\* Check that the jumper (J8) has not been cut. If it has been cut, contact the service shop.

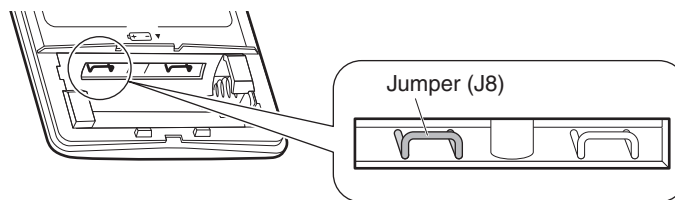

R7000230

## 3.2 FDMQ, FFQ Series

## Outline

- Make sure to install the decoration panel before carrying out trial operation if the wireless remote controller is used (FFQ series only).
  - Trial operation should be carried out in either cooling or heating operation.
1. Measure the supply voltage and make sure that it is within the specified range.
  2. In cooling operation, select the lowest programmable temperature; in heating operation, select the highest programmable temperature.
  3. Carry out the trial operation following the instructions in the operation manual to ensure that all functions and parts, such as the movement of the flaps, are working properly.
    - To protect the air conditioner, restart operation is disabled for 3 minutes after the system has been turned off.
  4. After trial operation is complete, set the temperature to a normal level (26°C to 28°C (78°F to 82°F) in cooling operation, 20°C to 24°C (68°F to 75°F) in heating operation).



## Caution

When performing field settings or trial operation without attaching the decoration panel, do not touch the drain pump. This may cause electric shock.  
After finishing the construction of refrigerant piping, drain piping, and electric wiring, conduct trial operation accordingly to protect the unit (FFQ series only).

## Procedure



When operating the air conditioner in cooling operation in winter, or heating operation in summer, set it to the trial operation mode using the following method.

■ With BRC1E73 Wired Remote Controller

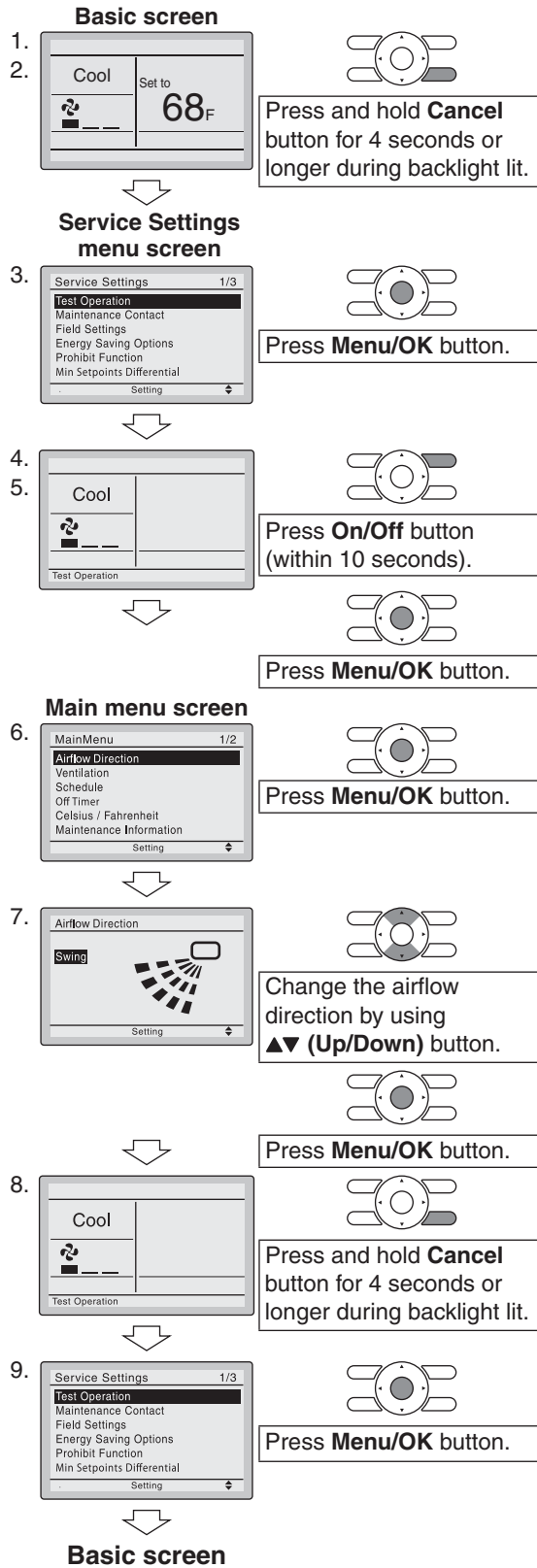
1. Set to COOL or HEAT operation using the remote controller.
2. Press and hold **Cancel** button for 4 seconds or longer. Service settings menu is displayed.
3. In the case of a model having airflow direction function, select **Test Operation** in the service settings menu, and press **Menu/OK** button. Basic screen returns and "Test Operation" is displayed at the bottom.
4. Press **On/Off** button within 10 seconds, and the test operation starts. Monitor the operation of the indoor unit for a minimum of 10 minutes. During test operation, the indoor unit will continue to cool/heat regardless of the temperature setpoint and room temperature.
  - ◆ In the case of above-mentioned procedures 3 and 4 in reverse order, test operation can start as well.
5. Press **Menu/OK** button in the basic screen. Main menu is displayed.
6. Select **Airflow Direction** in the main menu and press **Menu/OK** button. Check that airflow direction is actuated according to the setting. For operation of airflow direction setting, see the operation manual.
7. After the operation of airflow direction is confirmed, press **Menu/OK** button. Basic screen returns.
8. Press and hold **Cancel** button for 4 seconds or longer in the basic screen. Service settings menu is displayed.
9. Select **Test Operation** in the service settings menu, and press **Menu/OK** button. Basic screen returns and normal operation is conducted.
  - ◆ Test operation will stop automatically after 15 ~ 30 minutes. To stop the operation, press **On/Off** button.
10. If the decoration panel has not been installed, turn off the power after the test operation (FFQ series only).



■ **With BRC082A43, BRC082A41W, BRC082A42W(S) Wireless Remote Controller**

1. Press  button and select the COOL or HEAT operation.
2. Press  button twice. "TEST" is displayed.
3. Press  button within 10 seconds, and the test operation starts.

Monitor the operation of the indoor unit for a minimum of 10 minutes. During test operation, the indoor unit will continue to cool/heat regardless of the temperature setpoint and room temperature.

- ◆ In the case of above-mentioned procedures (1) and (2) in reverse order, test operation can start as well.
- ◆ Test operation will stop automatically after 15 ~ 30 minutes.

To stop the operation, press  button.

- ◆ Some of the functions cannot be used in the test operation mode.

### Test Items

Test items	Symptoms
Indoor and outdoor units are installed securely.	Fall, vibration, noise
Is the outdoor unit fully installed?	No operation or burn damage
No refrigerant gas leaks.	Incomplete cooling/heating function
Refrigerant gas and liquid pipes and indoor drain hose extension are thermally insulated.	Water leakage
Draining line is properly installed.	Water leakage
Does the power supply voltage correspond to that shown on the name plate?	No operation or burn damage
Only specified wires are used for all wiring, and all wires are connected correctly.	No operation or burn damage
System is properly grounded.	Electrical leakage
Is wiring size according to specifications?	No operation or burn damage
Is something blocking the air outlet or inlet of either the indoor or outdoor units?	Incomplete cooling/heating function
Are refrigerant piping length and additional refrigerant charge noted down?	The refrigerant charge in the system is not clear
Pipes and wires are connected to the corresponding connection ports/terminal blocks for the connected unit.	No cooling/heating
Stop valves are opened.	Incomplete cooling/heating function
Check that the connector of the lead wires of the decoration panel is connected securely.	Louvers do not move
Indoor unit properly receives wireless remote control commands.	No operation
The external static pressure is set correctly.	Incomplete cooling/heating function or water leakage

# 4. Field Settings for FTXR Series

## 4.1 Temperature Display Switch

**Procedure**

- Press the upper side of **Temp** button and **On** button at the same time for 5 seconds to change the unit of temperature display.

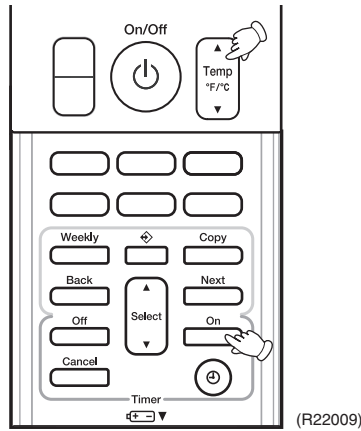

## 4.2 When 2 Units are Installed in 1 Room

**Outline**

When 2 indoor units are installed in 1 room, 1 of the 2 indoor units and the corresponding wireless remote controller can be set for different address.

**Indoor Unit PCB**

1. Remove the front grille.
2. Remove the shield plate of the electrical box.
3. Cut the address setting jumper JA on the PCB.

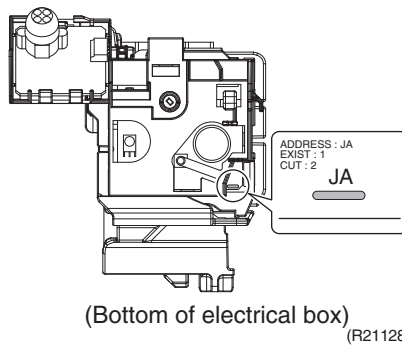

**Replace the PCB if you cut a jumper unintentionally.**

Jumpers are necessary for electronic circuit. Improper operation may occur if you cut any of them.

**Wireless Remote Controller**

1. Slide down the cover and take it off.
2. Cut the address setting jumper J4.
  - Be careful not to cut the jumper J8.

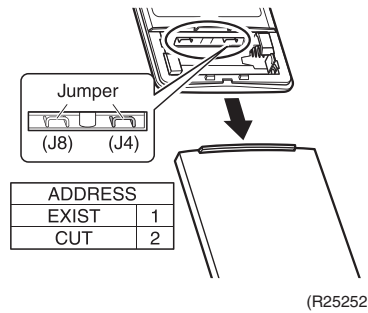
**Caution**

**Replace the remote controller if you cut a jumper unintentionally.**

Jumpers are necessary for electronic circuit. Improper operation may occur if you cut any of them.

### 4.3 Jumper and Switch Settings

Jumper on indoor unit PCB	Function	When connected (factory setting)	When cut
JB	Fan speed setting when compressor stops for thermostat OFF. (effective only at cooling operation)	The fan stops.	Fan speed setting; Remote controller setting
JC	Power failure recovery function	Auto-restart	The unit does not resume operation after recovering from a power failure. Timer settings are cleared.

**Reference**

For the location of the jumper, refer to 23 page.

# 5. Field Settings for FDMQ, FFQ Series

## 5.1 How to Change the Field Settings

**Outline**

If optional accessories are mounted on the indoor unit, the indoor unit setting may have to be changed. Refer to the instruction manual for each optional accessory.

**i Note**

When using 2 remote controllers for 1 indoor unit, change the field settings from MAIN remote controller. Note that the field settings cannot be set from SUB remote controller.

**Procedure**

**BRC1E73 Wired Remote Controller**

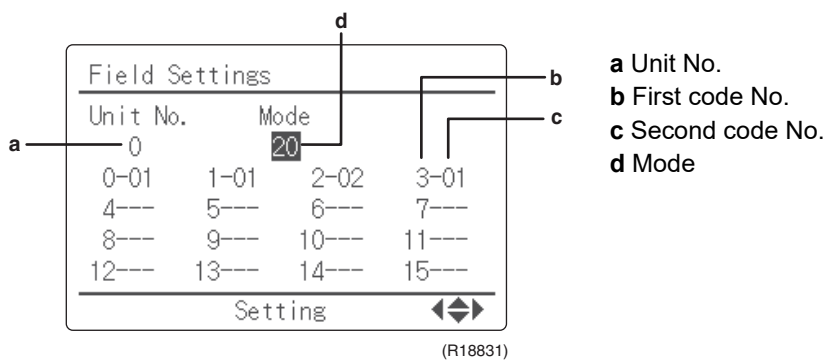

1. Press and hold **Cancel** button for 4 seconds or longer. Service settings menu is displayed.

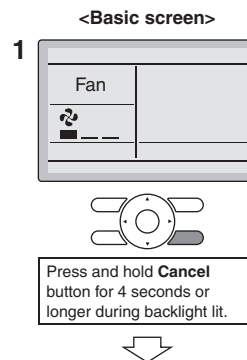

2. Select **Field Settings** in the Service Settings menu, and press **Menu/OK** button. Field settings screen is displayed.

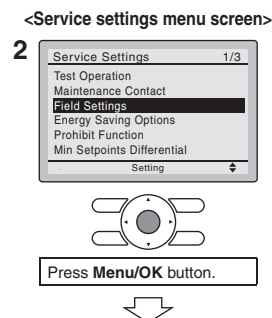

3. Highlight the mode, and select desired "Mode No." by using ▲ ▼ (Up/Down) button.
4. In the case of setting per indoor unit during group control (When Mode No. such as **20**, **22**, **23**, **25** are selected), highlight the unit No. and select "Indoor unit No." to be set by using ▲ ▼ (Up/Down) button. (In the case of group setting, this operation is not needed.)  
[ In the case of individual setting per indoor unit, current settings are displayed. And, SECOND CODE NO. " - " means no function. ]
5. Highlight SECOND CODE NO. of the FIRST CODE NO. to be changed, and select desired "SECOND CODE NO." by using ▲ ▼ (Up/Down) button. Multiple identical mode number settings are available.  
[ In the case of setting for all indoor units in the remote control group, available SECOND CODE NO. is displayed as " \* " which means it can be changed. When SECOND CODE NO. is displayed as " - ", there is no function. ]

<Service settings screen>

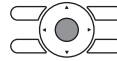
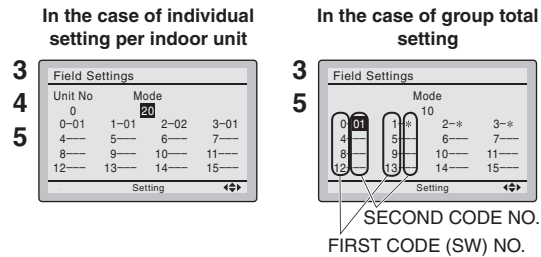

Press Menu/OK button.

6. Press **Menu/OK** button. Setting confirmation screen is displayed.
7. Select **Yes** and press **Menu/OK** button. Setting details are determined and field settings screen returns.
8. In the case of multiple setting changes, repeat 3 to 7.
9. After all setting changes are completed, press **Cancel** button twice.
10. Backlight goes out, and **[Checking the connection. Please stand by.]** is displayed for initialization. After the initialization, the basic screen returns.



<Setting confirmation screen>

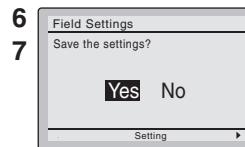

Press Menu/OK button.



Setting confirmation



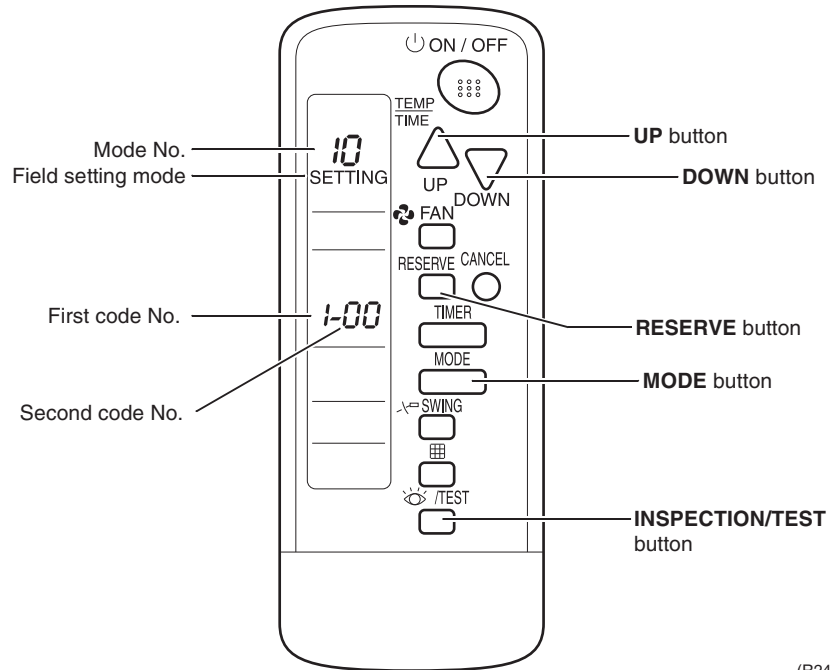

**BRC082A43, BRC082A41W, BRC082A42W(S) Wireless Remote Controller**



(R24061)

To set the field settings, you have to change:

- Mode No.
- First code No.
- Second code No.

1. When in normal mode, hold down /TEST button for at least 4 seconds to enter the Field Set mode.
2. Select the desired Mode No. with **MODE** button.
3. Press  button and select the First code No.
4. Press  button and select the Second code No.
5. Press **RESERVE** button to confirm the settings.
6. Press /TEST button to quit the Field Set mode and to return to normal display again.



## 5.2 Overview of Field Settings for FDMQ Series

Mode No.	First Code No.	Description of setting		Second Code No.							
				01	02	03	04	05	06		
10 (20)	0	Filter cleaning sign interval (used to change filter cleaning display interval according to filter contamination)	Longlife filter	Light★	Approx. 2,500 hrs.	Heavy	Approx. 1,250 hrs.	—	—	—	—
			Standard filter		Approx. 200 hrs.		Approx. 100 hrs.	—	—	—	—
	3	Filter cleaning sign (used to set filter cleaning display ON/OFF)		Display★	No display	—	—	—	—	—	
11 (21)	7	Air volume adjustment		OFF★	Air volume adjustment completion	Air volume adjustment start	—	—	—		
13 (23)	6	External static pressure		Refer to the table below.							

★ Factory Setting



### Note(s)

- The Second Code No. is factory set to "01".
- Do not use any settings not listed in the table.
- For group control with a wireless remote controller, initial settings for all the indoor units of the group are equal.  
For group control, refer to the installation manual attached to the indoor unit for group control.

### External Static Pressure Settings

Mode No.	First Code No.	Second Code No.		External static pressure
		09/12 Class	15/18/24 Class	
13 (23)	6	03	—	30 Pa (0.12 inH <sub>2</sub> O)
		04	—	40 Pa (0.16 inH <sub>2</sub> O)
		05★	05★	50 Pa (0.20 inH <sub>2</sub> O)★
		06	06	60 Pa (0.24 inH <sub>2</sub> O)
		07	07	70 Pa (0.28 inH <sub>2</sub> O)
		08	08	80 Pa (0.32 inH <sub>2</sub> O)
		09	09	90 Pa (0.36 inH <sub>2</sub> O)
		10	10	100 Pa (0.40 inH <sub>2</sub> O)
		11	11	110 Pa (0.44 inH <sub>2</sub> O)
		12	12	120 Pa (0.48 inH <sub>2</sub> O)
		13	13	130 Pa (0.52 inH <sub>2</sub> O)
		14	14	140 Pa (0.56 inH <sub>2</sub> O)
15	15	150 Pa (0.60 inH <sub>2</sub> O)		

★ Factory Setting

## 5.3 Overview of Field Settings for FFQ Series

Mode No.	First Code No.	Description of setting		Second Code No.					
				01	02	03	04	05	06
10 (20)	0	Filter cleaning sign interval	Longlife filter	Light★ Approx. 2,500 hrs.	Heavy Approx. 1,250 hrs.	—	—	—	—
	2	Remote controller thermistor		Enabled	Disabled★	—	—	—	—
	3	Filter cleaning sign		Display★	No display	—	—	—	—
12 (22)	0	Optional accessories output selection (field selection of output for adaptor for wiring)		Compressor★	—	Operation output	Error output	Outdoor air intake	Presence sensor
13 (23)	0	High air outlet velocity (for high ceiling applications)		≤ 2.7 m★ (≤ 8-7/8 ft)	2.7 ~ 3.0 m (8-7/8~9-13/16 ft)	3.0 ~ 3.5 m (9-13/16~11-1/2 ft)	—	—	—
	1	Selection of airflow direction (setting for when a blocking pad kit has been installed)		4-way flow★	3-way flow	2-way flow	—	—	—
	4	Airflow direction range setting		Upper	Normal★	Lower	—	—	—
15 (25)	3	Drain pump operation with humidifying		Not equipped★	Equipped	—	—	—	—

★ Factory Setting



**Note(s)** Any function that is not available on the indoor unit is not displayed.

## 5.4 MAIN/SUB Setting when Using 2 Wired Remote Controllers

### Outline

The MAIN/SUB setting is necessary when 1 indoor unit is controlled by 2 remote controllers. When you use 2 remote controllers, set one to MAIN and the other to SUB.

### Details

- The following message is displayed after power-on.

#### Checking the connection.

#### Please stand by.

When the above message is displayed, the backlight will not be ON.

#### [In the case that 1 indoor unit is controlled by 2 remote controllers:]

Make sure to set the sub remote controller when the above message is displayed.

Hold **Mode** button for 4 seconds or longer to set.

When the display is changed from “Main RC” to “Sub RC”, the setting is completed.

- Basic screen is displayed.

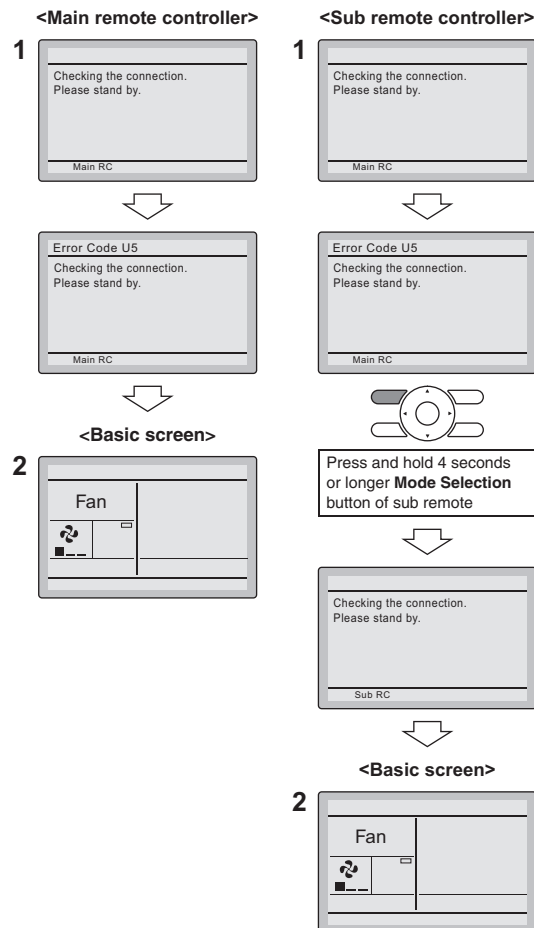

## 5.5 MAIN/SUB and Address Setting for Wireless Remote Controller for FDMQ Series

### Outline

- If setting multiple wireless remote controllers to operate in one room, perform address setting for the receiver and the wireless remote controller.
- If using both a wired remote controller and a wireless remote controller with 1 indoor unit, change the MAIN/SUB switch of the signal receiver PCB.

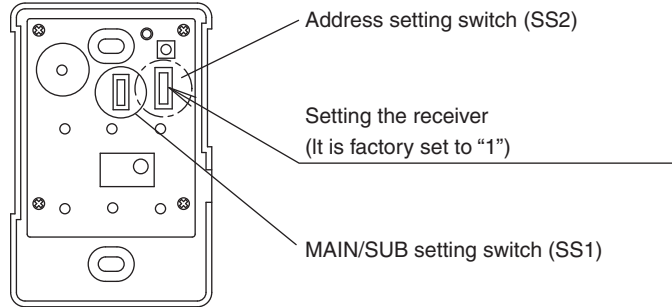

### Signal Receiver PCB Setting



(R24951)



#### MAIN/SUB switch

Set the MAIN/SUB setting switch (SS1) on the signal receiver PCB to SUB.

	MAIN	SUB
MAIN/SUB setting switch (SS1)	 R7000181	 R7000182

#### Wireless address switch

Set the address setting switch (SS2) on the signal receiver PCB according to the table below.

	No.1	No.2	No.3
Address setting switch (SS2)	 R7000183	 R7000184	 R7000185

**Wireless Remote Controller Address**

Factory set is 1. Change the wireless remote controller address setting by the following steps, if necessary.

1. Hold down button and /TEST button at the same time for at least 4 seconds to enter the field setting mode. (SETTING is indicated on the display).
2. Press FAN button and select display setting (A or B). Each time the button is pressed, the display switches between A and B.
3. Press button and button to set the address.

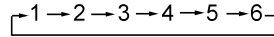

Address can be set from 1 ~ 6, but set it to 1 ~ 3 and to same address as the receiver. The receiver does not work with address 4 ~ 6.

4. Press **RESERVE** button to confirm the setting.
5. Hold down /TEST button to quit the field setting mode and return to the normal display.

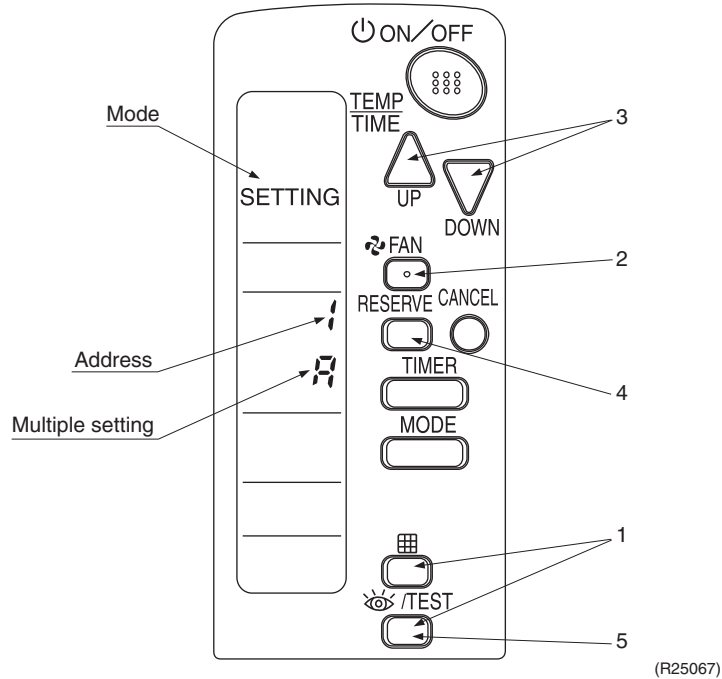

**Multiple Settings  
A or b**

When the indoor unit is controlled by an outside controller (central remote controller, etc.), the indoor unit sometimes does not respond to ON/OFF command or temperature setting command from the wireless remote controller. Check what setting the customer needs and make the multiple setting as shown below.

Remote Controller		Indoor Unit	
Multiple settings	Remote controller display	To control other air conditions and units	For other than on left
<b>A: Standard</b>	All items displayed.	Commands other than ON/OFF and temperature setting accepted. (1 LONG BEEP or 3 SHORT BEEPS emitted)	All commands accepted. (2 SHORT BEEPS)
<b>b: Multi System</b>	Operations remain displayed shortly after execution	All commands accepted. (2 SHORT BEEPS)	

**After Setting**

Stick the Unit No. label on the receiver and the back of the wireless remote controller.

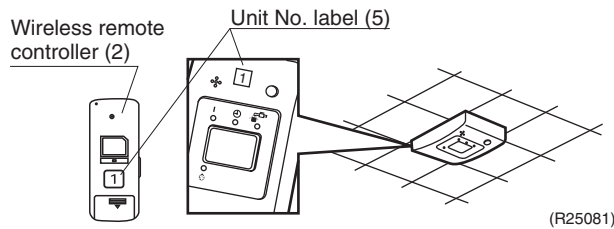

**i Note(s)**

Set the Unit No. of the receiver and the wireless remote controller to be the equal. If the settings differ, the signal from the remote controller cannot be transmitted.

## 5.6 MAIN/SUB and Address Setting for Wireless Remote Controller for FFQ Series

### Outline

- If setting multiple wireless remote controllers to operate in one room, perform address setting for the receiver and the wireless remote controller.
- If using both a wired remote controller and a wireless remote controller with 1 indoor unit, change the MAIN/SUB switch of the transmitter board.

### Transmitter Board

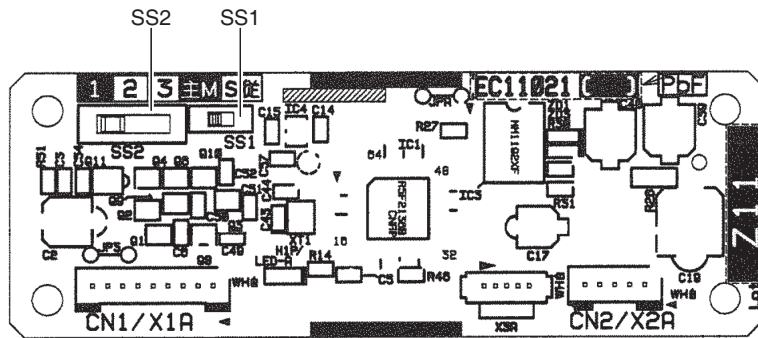

R7000371

#### MAIN/SUB switch

When using both a wired and a wireless remote controller for 1 indoor unit, the wired controller should be set to MAIN. Therefore, set the MAIN/SUB switch (SS1) of the transmitter board to SUB.

	MAIN	SUB
MAIN/SUB setting switch (SS1)	 M S (R24062)	 M S (R24063)

#### Wireless address switch

Set the wireless address setting switch (SS2) on the transmitter board according to the table below.

Unit No.	No.1	No.2	No.3
Address setting switch (SS2)	 1 2 3 (S1935)	 1 2 3 (S1936)	 1 2 3 (S1937)

**Wireless Remote Controller Address**

Factory set is 1. Change the wireless remote controller address setting by the following steps, if necessary.

1. Hold down button and /TEST button at the same time for at least 4 seconds to enter the field setting mode. (SETTING is indicated on the display).  
Press FAN button and select display setting (**A** or **b**). Each time the button is pressed, the display switches between **A** and **b**.
2. Press button and button to set the address.

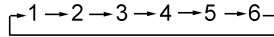

Address can be set from 1 ~ 6, but set it to 1 ~ 3 and to same address as the transmitter board. The transmitter board does not work with address 4 ~ 6.

3. Press **RESERVE** button to confirm the setting.
4. Hold down /TEST button to quit the field setting mode and return to the normal display.

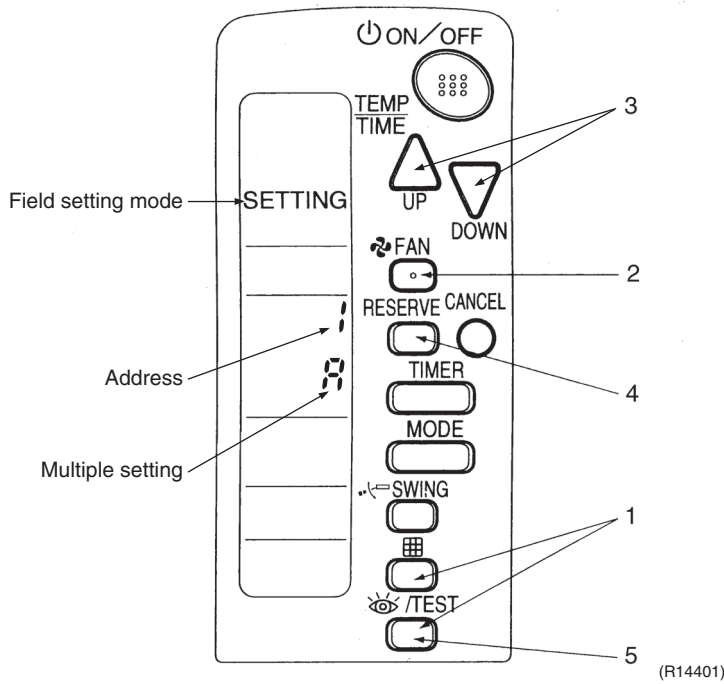



### Multiple Settings A or b

When the indoor unit is controlled by an outside controller (central remote controller, etc.), the indoor unit sometimes does not respond to ON/OFF command or temperature setting command from the wireless remote controller. Check what setting the customer needs and make the multiple setting as shown below.

Remote Controller		Indoor Unit	
Multiple settings	Remote controller display	To control other air conditions and units	For other than on left
<b>A: Standard</b>	All items displayed.	Commands other than ON/OFF and temperature setting accepted. (1 LONG BEEP or 3 SHORT BEEPS emitted)	All commands accepted. (2 SHORT BEEPS)
<b>b: Multi System</b>	Operations remain displayed shortly after execution	All commands accepted. (2 SHORT BEEPS)	

### After Setting

Affix corresponding unit number labels onto both air outlet of the decoration panel and onto back of the wireless remote controller.

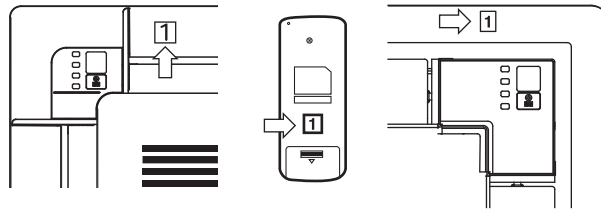

(R24066)



### Note(s)

Set the Unit No. of the receiver and the wireless remote controller to be the equal. If the settings differ, the signal from the remote controller cannot be transmitted.

## 6. Field Settings for Outdoor Unit

### 6.1 Facility Setting (cooling at low outdoor temperature)

#### Outline

This function is limited only for facilities (the target of air conditioning is equipment such as computers). Never use it in a residence or office (the space where there is a human).

#### Details

- Cutting jumper J6 on the outdoor unit PCB will extend the operation range to 14°F (–10°C). Installing an air direction adjustment grille (sold separately) will further extend the operation range to –4°F (–20°C). In these cases, the unit will stop operating if the outdoor temperature falls below –4°F (–20°C), restarting once the temperature rises above this level.
  - (1) Remove the top plate of the outdoor unit. (09/12 class: 4 screws, 15/18/24 class: 6 screws)
  - (2) Remove the front plate. (09/12 class: 5 screws, 15/18/24 class: 8 screws)
  - (3) Cut the jumper J6 of the PCB inside.

#### ● 09/12 class

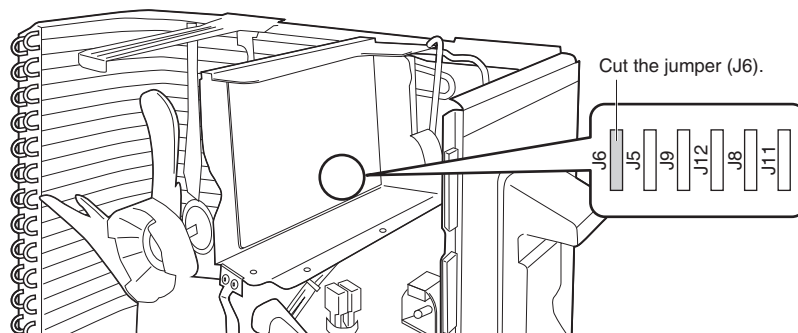

R7000390

#### ● 15/18/24 class

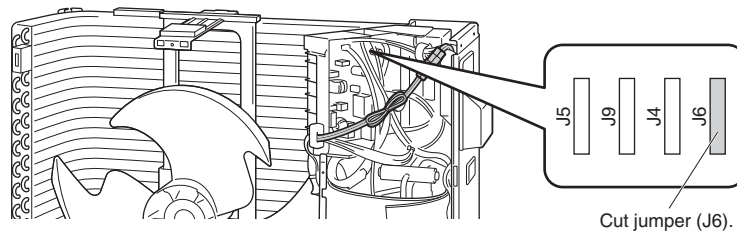

R7000391



#### Reference

For the location of the jumper, refer to pages 32, 34.



#### Caution

- If the outdoor unit is installed where the heat exchanger of the unit is exposed to direct wind, provide a windbreak wall.
- Intermittent noises may be produced by the indoor unit due to the outdoor fan turning on and off when using facility settings.
- Do not place humidifiers or other items which might raise the humidity in rooms where facility settings are being used.
 

A humidifier might cause dew jumping from the indoor unit outlet vent.
- Cutting jumper 6 (J6) sets the indoor fan tap to the highest position. Notify the user about this.



#### Caution

**Replace the remote controller if you cut a jumper unintentionally.**

Jumpers are necessary for electronic circuit. Improper operation may occur if you cut any of them.

## 6.2 Warmer Airflow Setting

### Outline

The temperature of discharge airflow in heating operation can be adjusted warmer.

- The room temperature will be high when getting close to the set temperature.
- The discharge airflow does not become warmer in other than heating operation.

### Procedure

Warmer airflow can be enabled from outdoor unit.

Cut the jumper (J5) of the PCB inside.

#### ■ 09/12 Class

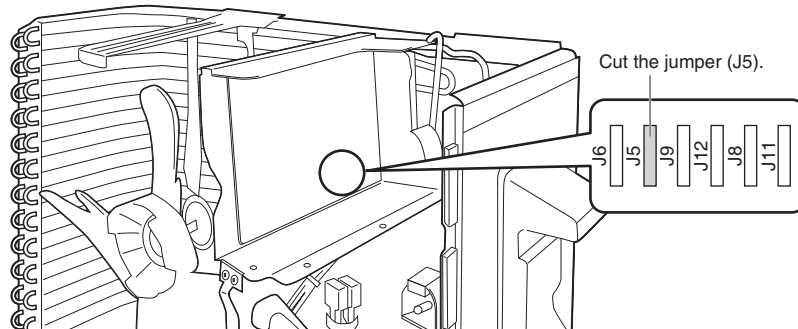

R7000387

#### ■ 15/18/24 Class

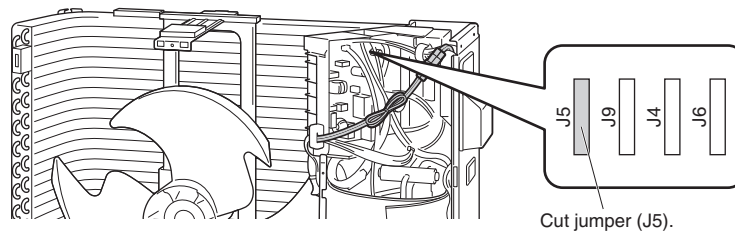

R7000388



### Reference

For the location of the jumper, refer to page 32, 34.



### Note(s)

Warmer airflow can be enabled from either indoor or outdoor unit.

Warmer airflow becomes available when either one of the RC or outdoor unit setting is enabled. For example, if the outdoor unit has the switch for warmer airflow, it can be set even when it is disabled on the indoor unit.

Also, for the wireless remote controller with field setting function, warmer airflow is enabled when set on indoor unit with the remote controller field setting, even when it is disabled on outdoor unit.

## 6.3 Drain Pan Heater

In high humidity areas or heavy snow areas, it is recommended to attach a drain pan heater to prevent ice build-up from the bottom frame.

1. Attach the drain pan heater in accordance with the installation manual included with the drain pan heater.
2. Cut the jumper (J9) of the PCB inside.

■ **09/12 class**

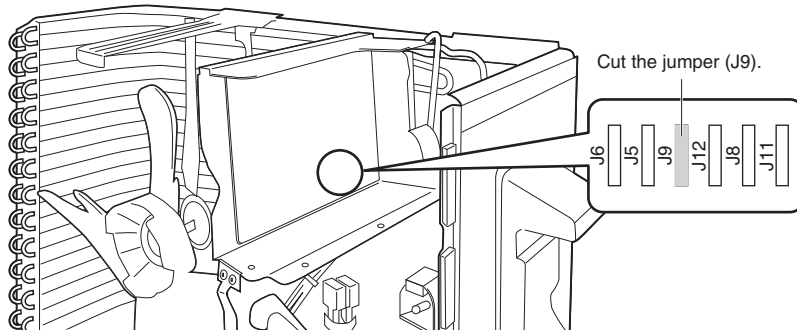

R7000384

■ **15/18/24 class**

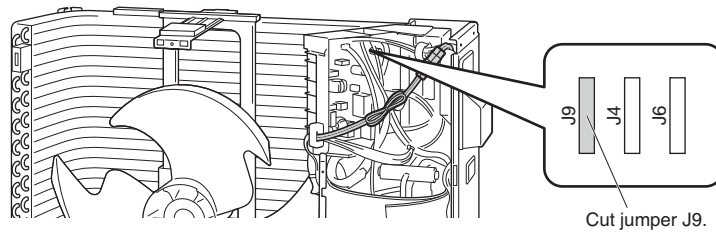

R7000385



**Reference**

For the location of the jumper, refer to page 32, 34.

## 7. Silicone Grease on Power Transistor/Diode Bridge

### Outline

Apply the specified silicone grease to the heat generation part of a power transistor/diode bridge when you replace an outdoor unit PCB. The silicone grease encourages the heat dissipation of a power transistor/diode bridge.

### Details

1. Wipe off the old silicone grease completely.
2. Apply the silicone grease evenly. See the illustrations below for examples of application.
3. Tighten the screws of the power transistor/diode bridge.
4. Make sure that the heat generation parts are firmly contacted to the radiation fin.

Note: Smoke emission may be caused by bad heat radiation when the silicone grease is not appropriately applied.

- OK: Evenly applied

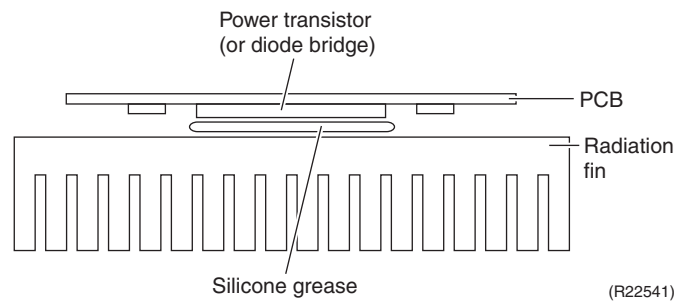

- NG: Not evenly applied

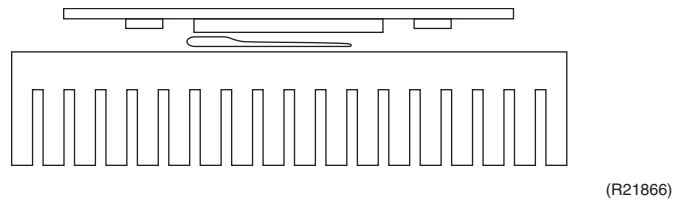

- NG: Foreign matter is stuck.

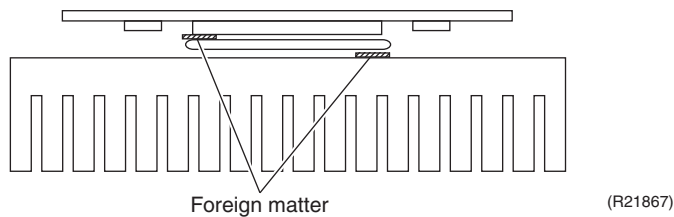

---

# Part 8 Appendix

1. Piping Diagrams.....	229
1.1 Indoor Unit.....	229
1.2 Outdoor Unit.....	230
2. Wiring Diagrams.....	232
2.1 Indoor Unit.....	232
2.2 Outdoor Unit.....	235
3. Operation Limit.....	237

# 1. Piping Diagrams

## 1.1 Indoor Unit

FTXR09/12WVJUW(S)9

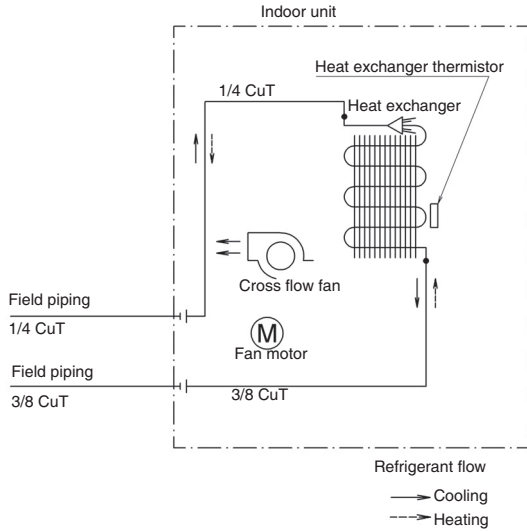

4D101008B

FTXR18WVJUW(S)9

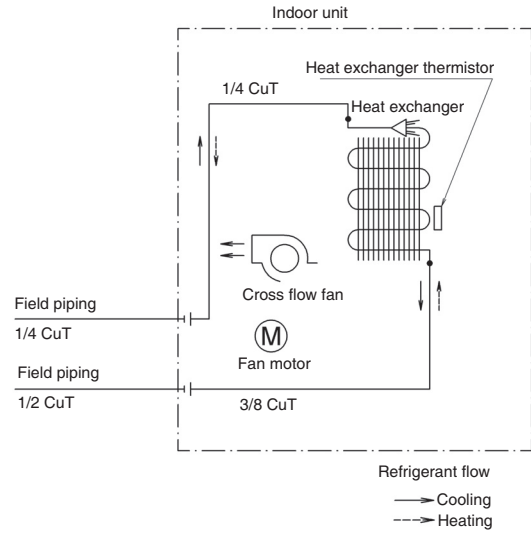

4D101010B

FDMQ09/12/15/18/24WVJU9

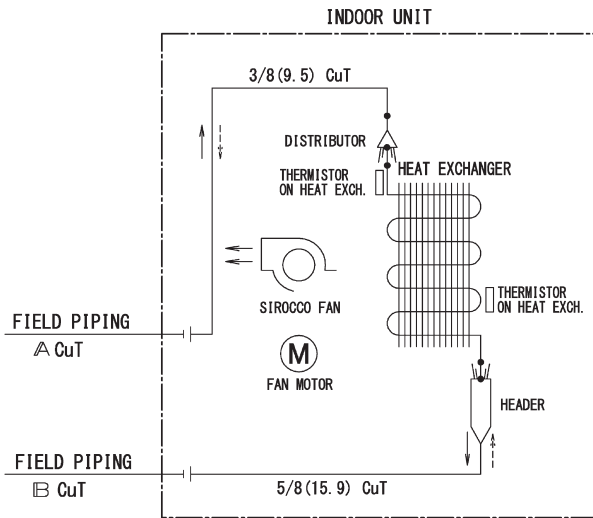

MODEL	A	B
FDMQ09 · 12	1/4 (6.4)	3/8 (9.5)
FDMQ15 · 18	1/4 (6.4)	1/2 (12.7)
FDMQ24	1/4 (6.4)	5/8 (15.9)

C: 4D112974B

FFQ09/12/15/18W2VJU9

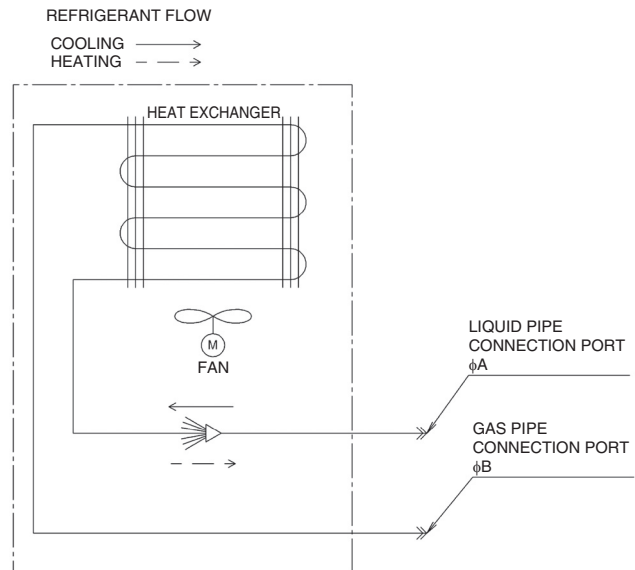

MODEL	A	B
FFQ09W2VJU9	1/4 (6.4)	3/8 (9.5)
FFQ12W2VJU9		
FFQ15W2VJU9		1/2 (12.7)
FFQ18W2VJU9		

C: 4D106033A

# 1.2 Outdoor Unit

## RX09/12WMVJU9

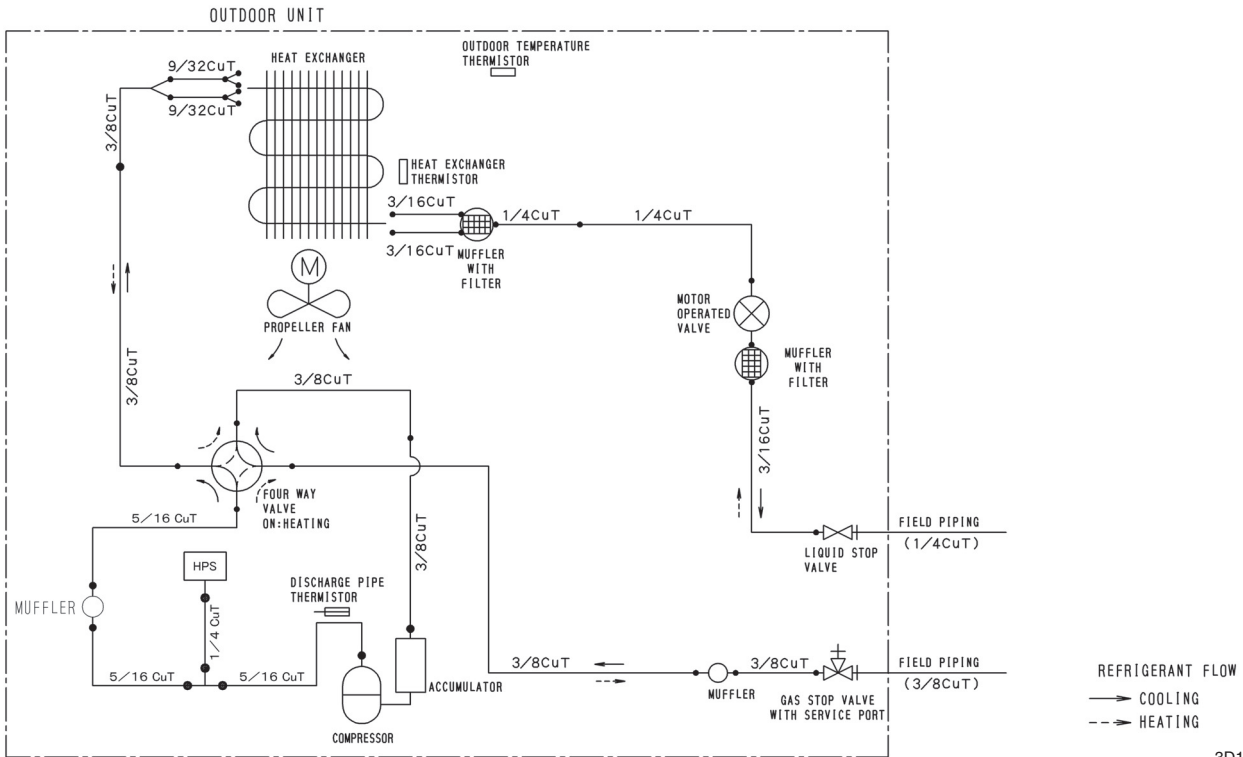

## RX15/18WMVJU9

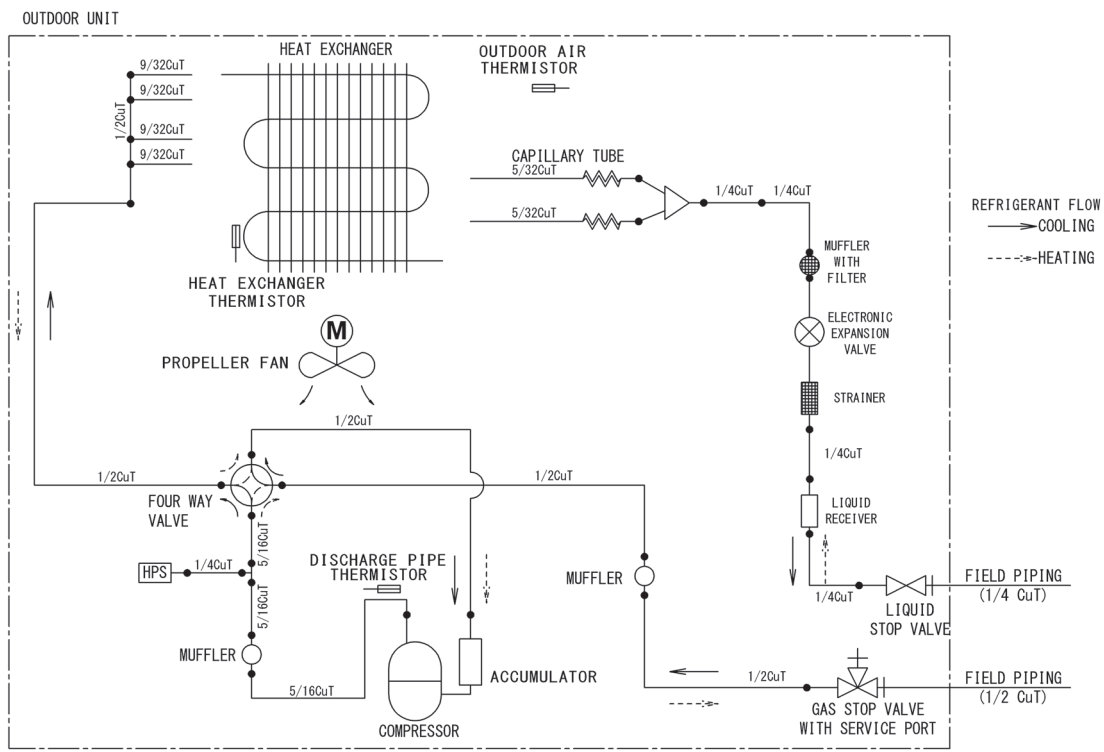



RX24WMVJU9

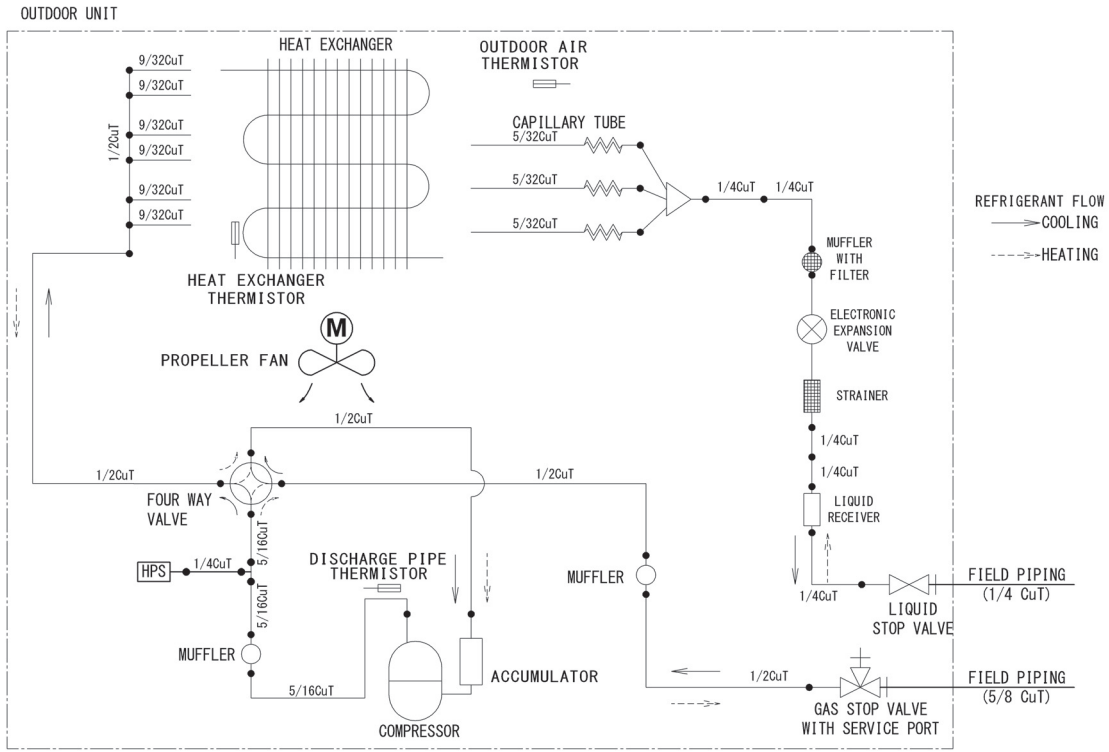

# 2. Wiring Diagrams

## 2.1 Indoor Unit

### FTXR09/12/18WVJUW(S)9

Wiring diagram

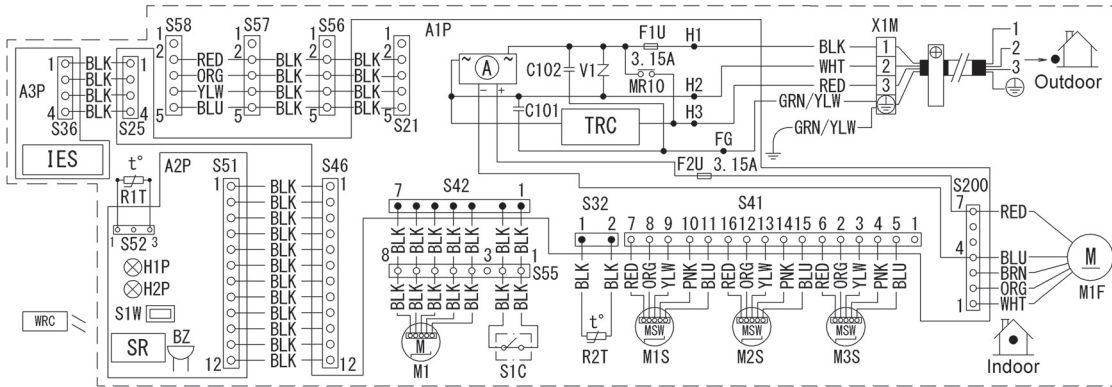

Field wiring

**NOTE** When the main power is turned off and then back on again, operation will resume automatically.

- |          |                           |            |                   |
|----------|---------------------------|------------|-------------------|
| FG       | : Frame ground            | SR         | : Signal receiver |
| F1U, F2U | : Fuse                    | ⊕          | : Ground          |
| H1P, H2P | : Pilot lamp              | H1-H3      | : Harness         |
| R1T, R2T | : Thermistor              | MR10       | : Magnetic relay  |
| S25-S200 | : Connector               | V1         | : Varistor        |
| S1W      | : Operation switch        | C101, C102 | : Capacitor       |
| S1C      | : Limit switch            |            |                   |
| X1M      | : Terminal strip          |            |                   |
| BZ       | : Buzzer                  |            |                   |
| M1F      | : Fan motor               |            |                   |
| M1S-M3S  | : Swing motor             |            |                   |
| M1       | : Stepper motor           |            |                   |
| A1P-A3P  | : Printed circuit board   |            |                   |
| TRC      | : Transmission circuit    |            |                   |
| WRC      | : Wireless remote control |            |                   |
| IES      | : Intelligent Eye sensor  |            |                   |
| (A)      | : Rectifier               |            |                   |

3D103375B



**Note**

A1P: Control PCB  
 A2P: Display/signal receiver PCB  
 A3P: INTELLIGENT EYE sensor PCB  
 Refer to page 23 for Printed Circuit Board Connector Wiring Diagram.

FDMQ09/12/15/18/24WVJU9

WIRING DIAGRAM

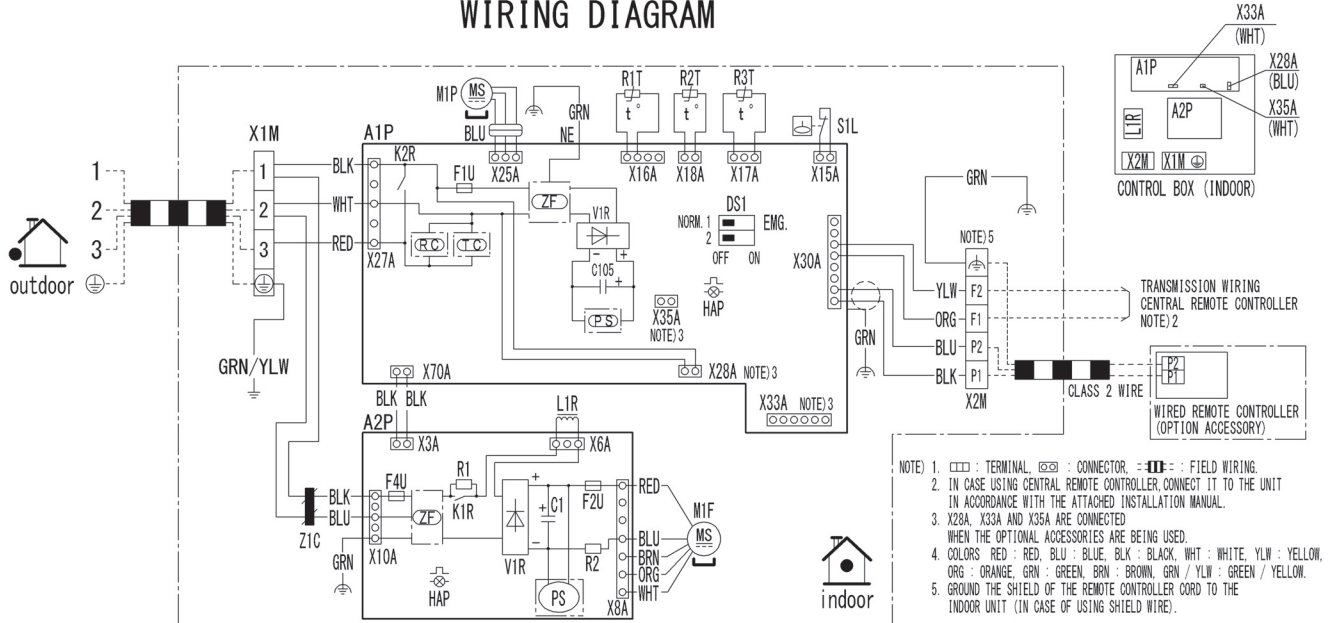

INDOOR UNIT	CONNECTOR	OPTIONAL ACCESSORY
A 1 P PRINTED CIRCUIT BOARD	X28A	CONNECTOR (POWER SUPPLY FOR WIRING)
A 2 P PRINTED CIRCUIT BOARD (FAN)	X33A	CONNECTOR (FOR WIRING)
C 1 CAPACITOR	X35A	CONNECTOR (ADAPTOR)
C105 CAPACITOR		
DS1 DIP SWITCH (EMERGENCY)		
F1U FUSE (T, 3.15A, 250V)		
F2U FUSE (T, 5A, 250V)		
F4U FUSE		
HAP PILOT LAMP (SERVICE MONITOR-GREEN)		
K1R MAGNETIC RELAY		
K2R MAGNETIC RELAY		
L1R REACTOR		
M1F MOTOR (FAN INDOOR)		
M1P MOTOR (DRAIN PUMP)		
R1 RESISTOR (CURRENT LIMITING)		
R2 CURRENT SENSING DEVICE		
R1T THERMISTOR (SUCTION AIR)		
R2T THERMISTOR (HEAT EXCHANGER)		
S1L FLOAT SWITCH		
V1R DIODE BRIDGE		
X1M TERMINAL BLOCK (POWER SUPPLY)		
X2M TERMINAL BLOCK (CONTROL)		
ZF NOISE FILTER		
Z1C FERRITE CORE		
PS SWITCHING POWER SUPPLY		
RC RECEIVER		
TC TRANSMITTER		

- NOTE) 1. □ : TERMINAL, ⊞ : CONNECTOR, - - - : FIELD WIRING.  
 2. IN CASE USING CENTRAL REMOTE CONTROLLER, CONNECT IT TO THE UNIT IN ACCORDANCE WITH THE ATTACHED INSTALLATION MANUAL.  
 3. X28A, X33A AND X35A ARE CONNECTED WHEN THE OPTIONAL ACCESSORIES ARE BEING USED.  
 4. COLORS : RED : RED, BLU : BLUE, BLK : BLACK, WHT : WHITE, YLW : YELLOW, ORG : ORANGE, GRN : GREEN, BRN : BROWN, GRN / YLW : GREEN / YELLOW.  
 5. GROUND THE SHIELD OF THE REMOTE CONTROLLER CORD TO THE INDOOR UNIT (IN CASE OF USING SHIELD WIRE).

3D112629B

**i** Note

A1P: Control PCB  
 A2P: Indoor fan PCB  
 Refer to page 25 for Printed Circuit Board Connector Wiring Diagram.

FFQ09/12/15/18W2VJU9

WIRING DIAGRAM

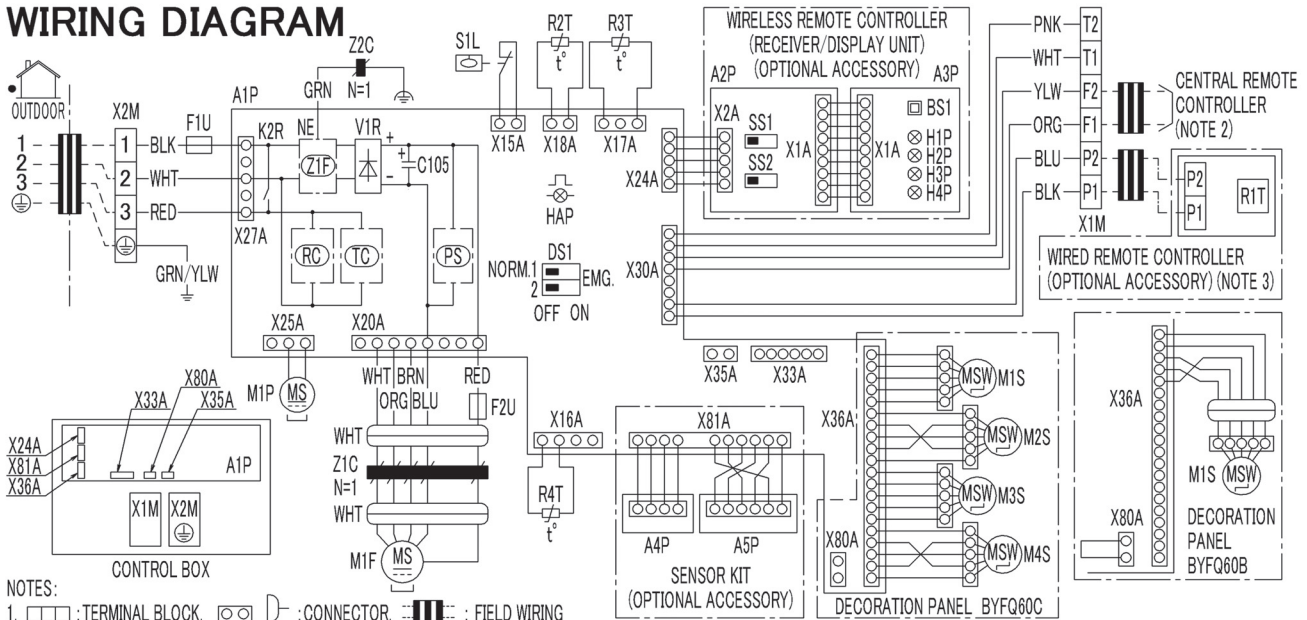

NOTES:

1. : TERMINAL BLOCK, : CONNECTOR, : FIELD WIRING
2. IN CASE USING CENTRAL REMOTE CONTROLLER, CONNECT IT TO THE UNIT IN ACCORDANCE WITH THE ATTACHED INSTALLATION MANUAL.
3. IN CASE OF MAIN/SUB CHANGEOVER, SEE THE INSTALLATION MANUAL ATTACHED TO WIRELESS REMOTE CONTROLLER.
4. SYMBOLS SHOW AS FOLLOWS: BLK:BLACK RED:RED BLU:BLUE WHT:WHITE YLW:YELLOW GRN:GREEN ORG:ORANGE BRN:BROWN PNK:PINK

INDOOR UNIT		WIRELESS REMOTE CONTROLLER (RECEIVER/DISPLAY UNIT)	
A1P	PRINTED CIRCUIT BOARD	A2P-A3P	PRINTED CIRCUIT BOARD
C105	CAPACITOR(M1F)	BS1	PUSH BUTTON SWITCH ON PCB
DS1	DIP SWITCH ON PCB	H1P	PILOT LAMP (ON-RED)
F1U	FUSE(F.5A,250V)	H2P	PILOT LAMP (TIMER-GREEN)
F2U	FUSE(F.3.15A,500V)	H3P	PILOT LAMP (FILTER SIGN-RED)
HAP	FLASHING LAMP (SERVICE MONITOR GREEN)	H4P	PILOT LAMP (DEFROST-ORANGE)
K2R	MAGNETIC RELAY	SS1	SELECTOR SWITCH (MAIN-SUB)
M1F	FAN MOTOR	SS2	SELECTOR SWITCH (WIRELESS ADDRESS SET)
M1P	DRAIN PUMP MOTOR	SENSOR KIT	
M1S-M2S	SWING MOTOR	A4P	PRINTED CIRCUIT BOARD
M3S-M4S		A5P	PRINTED CIRCUIT BOARD
R2T-R3T	THERMISTOR(COIL)	CONNECTOR FOR OPTIONAL PARTS	
R4T	THERMISTOR(AIR)	X24A	CONNECTOR (WIRING REMOTE CONTROLLER)
S1L	FLOAT SWITCH	X33A	CONNECTOR (ADAPTOR FOR WIRING)
V1R	DIODE BRIDGE	X35A	CONNECTOR (POWER SUPPLY FOR ADAPTOR)
X1M	TERMINAL BLOCK	X81A	CONNECTOR (SENSOR KIT)
X2M	TERMINAL BLOCK		
Z1F	NOISE FILTER		
Z1C	FERRITE CORE		
Z2C	FERRITE CORE		
PS	SWITCHING POWER SUPPLY		
RC	RECEIVER		
TC	TRANSMITTER		
WIRED REMOTE CONTROLLER			
R1T	THERMISTOR(AIR)		

3D139759B

Note

- A1P: Control PCB
  - A2P: Transmitter board for wireless remote controller
  - A3P: Receiver for wireless remote controller
  - A4P: Thermopile sensor
  - A5P: Pyroelectric sensor
- Refer to page 27 for Printed Circuit Board Connector Wiring Diagram.

## 2.2 Outdoor Unit

### RX09/12WMVJU9

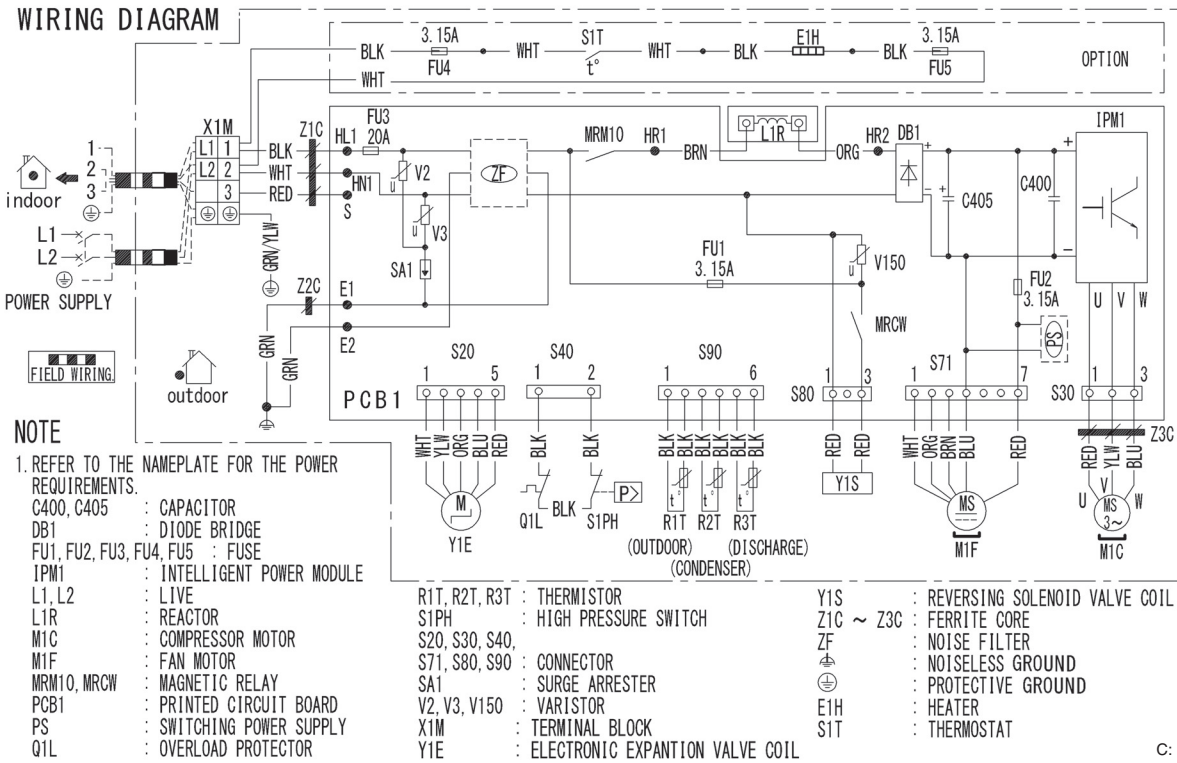

**Note(s)**

PCB1: Main PCB

Refer to page 32 for Printed Circuit Board Connector Wiring Diagram.

RX15/18/24WMVJU9

WIRING DIAGRAM

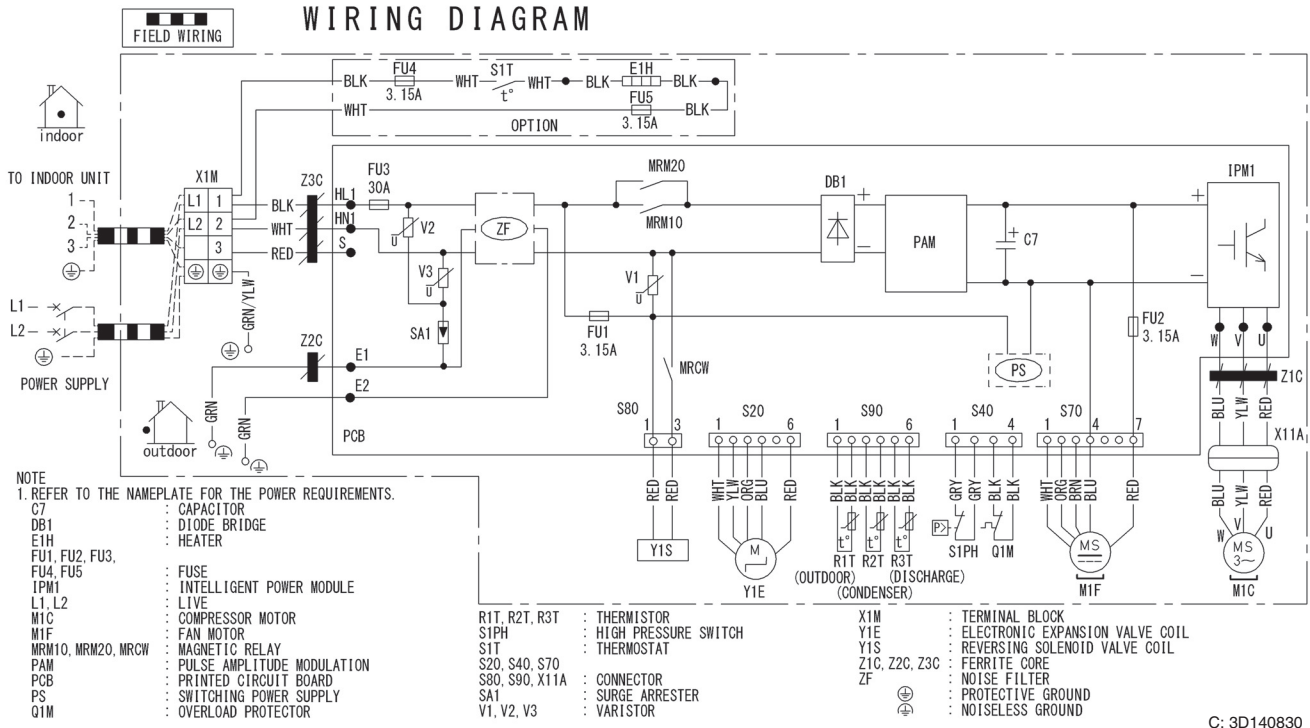

Note(s)

PCB: Main PCB  
 Refer to page 34 for Printed Circuit Board Connector Wiring Diagram.

# 3. Operation Limit

RX09/12/15/18/24WMVJU9

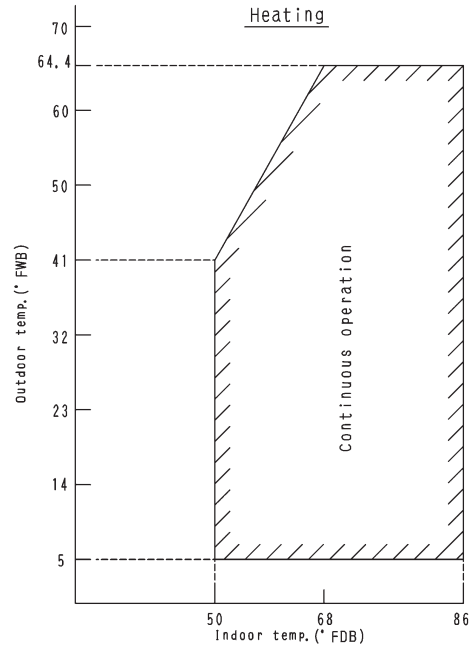
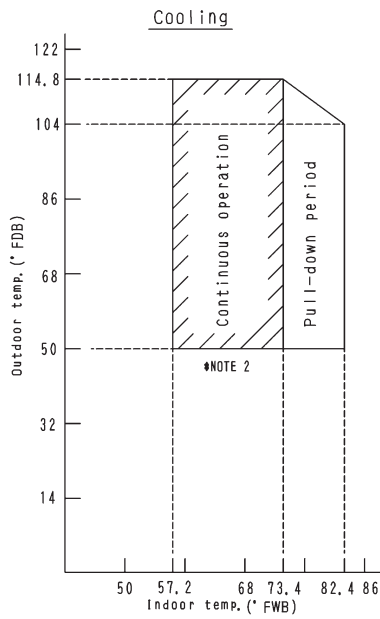

**Notes)**

- 1, The graphs are based on the following conditions.
- Equivalent piping length 25ft
  - Level difference 0ft

- 2, Facility Setting (cooling at low outdoor temperature : only for RX model)  
 This function is limited only for facilities (the target of air conditioning is equipment such as computer).  
 Never use it in a residence or office (The space where there is a human).  
 Indoor fan tap should be fixed to high.
- Cutting Jumper 6 (J6) on the circuit board : extend the operation range to 14° F(-10°C).
  - Installing an air direction adjustment grille (wind baffle)(sold separately) : extend the operation range to -4° F(-20°C).

3D092209F

**Warning**

- Daikin products are manufactured for export to numerous countries throughout the world. Prior to purchase, please confirm with your local authorized importer, distributor and/or retailer whether this product conforms to the applicable standards, and is suitable for use, in the region where the product will be used. This statement does not purport to exclude, restrict or modify the application of any local legislation.
- Ask a qualified installer or contractor to install this product. Do not try to install the product yourself. Improper installation can result in water or refrigerant leakage, electrical shock, fire or explosion.
- Use only those parts and accessories supplied or specified by Daikin. Ask a qualified installer or contractor to install those parts and accessories. Use of unauthorized parts and accessories or improper installation of parts and accessories can result in water or refrigerant leakage, electrical shock, fire or explosion.
- Read the user's manual carefully before using this product. The user's manual provides important safety instructions and warnings. Be sure to follow these instructions and warnings.

If you have any inquiries, please contact your local importer, distributor and/or retailer.

**Cautions on product corrosion**

1. Air conditioners should not be installed in areas where corrosive gases, such as acid gas or alkaline gas, are produced.
2. If the outdoor unit is to be installed close to the sea shore, direct exposure to the sea breeze should be avoided. If you need to install the outdoor unit close to the sea shore, contact your local distributor.

© All rights reserved