

Service Manual

Inverter Split Wall Mounted Heatpump [60Hz] Type FTXC Series



[Applied Models]
● Inverter Split : Heat Pump Unit

Introduction	1
1. Safety Cautions.....	2
1.1 Warnings and Cautions Regarding Safety of Workers.....	2
1.2 Warnings and Cautions Regarding Safety of Users.....	8
2. Icons Used	10
3. Revision History	11
Part 1 General Information	12
1. Applicable Models	13
Part 2 Specifications	15
1. Specification Data	16
2. Functions.....	20
Part 3 Functions and Control	21
1. Main Functions.....	22
1.1 Temperature Control	22
1.2 Frequency Control.....	22
1.3 Airflow Direction Control.....	24
1.4 Fan Speed Control for Indoor Unit	24
1.5 Dry Mode.....	25
1.6 Automatic Operation.....	26
1.7 Thermostat Control.....	27
1.8 ECO+ Operation.....	28
1.9 Sleep Mode	29
1.10 POWERFUL Operation	29
1.11 Other Functions.....	30
2. Thermistor Functions	31
3. Control Specification	32
3.1 Mode Hierarchy.....	32
3.2 Frequency Control.....	33
3.3 Standby Electricity Saving (Suspend Function)	35
3.4 Controls at Mode Changing/Start-up.....	35
3.5 Discharge Pipe Temperature Control.....	37
3.6 Input Current Control.....	38
3.7 Freeze-up Protection Control	39
3.8 Heating Peak-cut Control	40
3.9 Outdoor Fan Control.....	41
3.10 Liquid Compression Protection Function.....	42
3.11 Defrost Control	42
3.12 Electronic Expansion Valve Control	43
3.13 Malfunctions	47

Part 4 Remote Controller	48
1. Applicable Remote Controller	49
2. BRC52B63	50
Part 5 Service Diagnosis	51
1. General Problem Symptoms and Check Items	52
2. Troubleshooting with LED	53
2.1 Indoor Unit.....	53
2.2 Outdoor Unit.....	53
3. Error Diagnosis	54
3.1 To enter error diagnosis	54
4. Troubleshooting	55
4.1 Error Codes and Description	55
4.2 Indoor Unit PCB Abnormality	57
4.3 Freeze-up Protection Control	58
4.4 Indoor Fan Motor (DC Motor) or Related Abnormality	59
4.5 Thermistor or Related Abnormality (Indoor Unit).....	60
4.6 Thermistor or Related Abnormality (Indoor Unit).....	61
4.7 Low-voltage Detection or Over-voltage Detection	63
4.8 Signal Transmission Error (Between Indoor Unit and Outdoor Unit).....	65
4.9 Installation error.....	68
4.10 Outdoor Unit PCB Abnormality.....	71
4.11 Actuation of High Pressure Switch	72
4.12 OL Activation (Compressor Overload)	73
4.13 OL Activation (Compressor Overload) or HPS Activation (High Pressure Switch).....	75
4.14 Compressor Lock	77
4.15 DC Fan Lock	78
4.16 Input Overcurrent Detection	79
4.17 Discharge Pipe Temperature Control.....	80
4.18 High Pressure Control in Cooling	81
4.19 Compressor System Sensor Abnormality	83
4.20 Position Sensor Abnormality	84
4.21 Thermistor or Related Abnormality (Outdoor Unit).....	85
4.22 Electrical Box Temperature Rise	87
4.23 Radiation Fin Temperature Rise	88
4.24 Output Overcurrent Detection	90
4.25 Four Way Valve Abnormality.....	92
5. Actuator Check.....	94
5.1 Thermistor Resistance Check	94
5.2 Power Supply Waveform Check.....	95
5.3 Electronic Expansion Valve Check.....	95
5.4 Four Way Valve Performance Check	96
5.5 Inverter Unit Refrigerant System Check.....	97
5.6 Rotation Pulse Check on the Outdoor Unit PCB	97
5.7 Installation Condition Check.....	99
5.8 Discharge Pressure Check.....	99
5.9 Outdoor Fan System Check	100
5.10 Main Circuit Short Check.....	100
5.11 Power Module Check	102



Part 6 Trial Operation and Field Settings	103
1. Pump Down Operation	104
2. Forced Cooling Operation	105
3. Silicone Grease on Power Transistor/Diode Bridge	106
Part 7 Appendix	107
1. Piping Diagrams	108
1.1 Indoor Unit	108
1.2 Outdoor Unit	110
2. Wiring Diagrams	112
2.1 Indoor Unit	112
2.2 Outdoor Unit	113
2.3 Printed Circuit Board Connector Wiring Diagram	114
2.4 Printed Circuit Board Connector Wiring Diagram	115
3. Operation Limit	117

Introduction

1. Safety Cautions.....	2
1.1 Warnings and Cautions Regarding Safety of Workers.....	2
1.2 Warnings and Cautions Regarding Safety of Users.....	8
2. Icons Used	10
3. Revision History	11

1. Safety Cautions

Be sure to read the following safety cautions before conducting repair work. After the repair work is complete, be sure to conduct a test operation to ensure that the equipment operates normally, and explain the cautions for operating the product to the customer.

	This manual is for the person in charge of maintenance and inspection.		This appliance is filled with R32.
---	--	---	------------------------------------







Caution Items





The caution items are classified into **Warning** and **Caution**. The **Warning** items are especially important since death or serious injury can result if they are not followed closely. The **Caution** items can also lead to serious accidents under some conditions if they are not followed. Therefore, be sure to observe all the safety caution items described below.









Pictograms

- △ This symbol indicates an item for which caution must be exercised. The pictogram shows the item to which attention must be paid.
- This symbol indicates a prohibited action. The prohibited item or action is shown in the illustration or near the symbol.
- This symbol indicates an action that must be taken, or an instruction. The instruction is shown in the illustration or near the symbol.

1.1 Warnings and Cautions Regarding Safety of Workers

 Warning	
Do not store equipment in a room with fire sources (e.g., naked flames, gas appliances, electric heaters).	
Be sure to disconnect the power cable from the socket before disassembling equipment for repair. Working on equipment that is connected to the power supply may cause an electrical shock. If it is necessary to supply power to the equipment to conduct the repair or inspect the circuits, do not touch any electrically charged sections of the equipment.	
If refrigerant gas is discharged during repair work, do not touch the discharged refrigerant gas. Refrigerant gas may cause frostbite.	
When disconnecting the suction or discharge pipe of the compressor at the welded section, evacuate the refrigerant gas completely at a well-ventilated place first. If there is gas remaining inside the compressor, the refrigerant gas or refrigerating machine oil discharges when the pipe is disconnected, and it may cause injury.	
If refrigerant gas leaks during repair work, ventilate the area. Refrigerant gas may generate toxic gases when it contacts flames.	
Be sure to discharge the capacitor completely before conducting repair work. The step-up capacitor supplies high-voltage electricity to the electrical components of the outdoor unit. A charged capacitor may cause an electrical shock.	

 Warning	
<p>Do not turn the air conditioner on or off by plugging in or unplugging the power cable. Plugging in or unplugging the power cable to operate the equipment may cause an electrical shock or fire.</p>	
<p>Be sure to wear a safety helmet, gloves, and a safety belt when working in a high place (more than 2 m). Insufficient safety measures may cause a fall.</p>	
<p>In case of R-32 / R-410A refrigerant models, be sure to use pipes, flare nuts and tools intended for the exclusive use with the R-32 / R-410A refrigerant. The use of materials for R-22 refrigerant models may cause a serious accident, such as a damage of refrigerant cycle or equipment failure.</p>	
<p>Do not mix air or gas other than the specified refrigerant (R-32 / R-410A / R-22) in the refrigerant system. If air enters the refrigerant system, an excessively high pressure results, causing equipment damage and injury.</p>	

 Caution	
<p>Do not repair electrical components with wet hands. Working on the equipment with wet hands may cause an electrical shock.</p>	
<p>Do not clean the air conditioner with water. Washing the unit with water may cause an electrical shock.</p>	
<p>Be sure to provide an earth / grounding when repairing the equipment in a humid or wet place, to avoid electrical shocks.</p>	
<p>Be sure to turn off the power switch and unplug the power cable when cleaning the equipment. The internal fan rotates at a high speed, and may cause injury.</p>	
<p>Be sure to conduct repair work with appropriate tools. The use of inappropriate tools may cause injury.</p>	
<p>Be sure to check that the refrigerating cycle section has cooled down enough before conducting repair work. Working on the unit when the refrigerating cycle section is hot may cause burns.</p>	
<p>Conduct welding work in a well-ventilated place. Using the welder in an enclosed room may cause oxygen deficiency.</p>	

Safety Checklist

■ **Checking the area**

Before beginning work, conduct safety checks to minimise the risk of ignition. When repairing the refrigerating system, take the following precautions before work.

■ **Work procedure**

Work shall be conducted under a controlled procedure so as to minimise the risk of working in the presence of R32 or vapour.

■ **General working area**

All maintenance staff and others working in the local area shall be instructed on the nature of work being carried out.

Work in confined spaces shall be avoided.

The area around the workspace shall be sectioned off. Ensure that the conditions within the area have been made safe by control of flammable materials.

■ **Checking for presence of refrigerant**

The working area shall be checked with an appropriate refrigerant detector before and during work, to ensure the technician is aware of potentially flammable atmospheres.

Ensure that the leak detection equipment being used is suitable for use with R32, i.e. non-sparking, adequately sealed or intrinsically safe.

■ **Fire extinguishing equipment**

If any hot work is to be conducted on the refrigeration equipment or any associated parts, appropriate fire extinguishing equipment shall be made available at hand. Prepare a dry powder or CO₂ fire extinguisher adjacent to the working area.

■ **No ignition sources**

During work on a refrigeration system which involves exposing any piping work that contains or has contained R32, any sources of ignition shall not be used in a manner that may lead to the risk of fire or explosion. All possible ignition sources, including cigarette smoking, should be kept at a safe distance from the site of installation, repairing, or removing space. Before starting work, the area around the equipment shall be examined to make sure that there are no flammable hazard or ignition risks. No Smoking signs shall be displayed.

■ **Ventilated area**

Ensure that the working area is open or that it is adequately ventilated before work.

Adequate ventilation shall be maintained during the entire period of work.

The ventilation should disperse any released refrigerant and preferably discharge it into the external atmosphere.

■ **Checking the refrigeration equipment**

Where electrical components are to be changed, the new components shall be fit for the purpose and have the correct specifications.

The manufacturer's maintenance and service guidelines shall be followed at all times.

If there are any unclear points, consult the manufacturer's technical department for assistance.

The following checks shall be applied to any installation work involving R32:

- The amount of charge is in accordance with the size of the room where the refrigerant containing parts are installed;
- The ventilation machinery and outlets are operating adequately and are not obstructed;
- If an indirect refrigerating circuit is being used, the secondary circuit shall be checked for the presence of refrigerant;
- Marking on the equipment is visible and legible. Markings and signs that are illegible shall be corrected;
- Refrigeration pipes or components are installed in a position where they are unlikely to be exposed to any substance which may corrode refrigerant containing components, or the refrigerant containing components are constructed of materials which are inherently resistant to corrosion or are suitably protected against corrosion.

Safety Checklist (con't)

■ **Checking electrical devices**

Repair and maintenance to electrical components shall include initial safety checks and component inspection procedures. In case there is any fault that could endanger safety, no electrical supply shall be connected to the circuit until the fault is satisfactorily dealt with.

Initial safety checks shall include:

- that capacitors are discharged: this shall be done in a safe manner to avoid possibility of sparking;
- that no live electrical components and wiring are exposed while charging, recovering or purging the system;
- that the equipment is earthed at all times.

■ **Repairs to sealed components**

During repairs to sealed components, all electrical supplies shall be disconnected from the equipment being worked upon before the removal of any sealed covers, etc. If it is absolutely necessary to have power supplied to equipment during servicing, continuously operating leak detection shall be installed at the most dangerous point of the system in order to warn of a potentially hazardous situation.

Particular attention shall be paid to the following: ensure that working on electrical components does not alter the casing in such a way that affects the level of protection including damage to cables, excessive number of connections, terminals different from the original specification, damage to seals, incorrect fitting of glands, etc.

Ensure that the equipment is mounted securely.

Ensure that seals or sealing materials have not degraded such that they no longer serve the purpose of preventing the ingress of flammable atmospheres. Replacement parts shall be in accordance with the manufacturer's specifications.

The use of silicon sealant may inhibit the effectiveness of some types of leak detection equipment. Intrinsically safe components do not have to be isolated before working on them.

■ **Repair to intrinsically safe components**

Do not apply any permanent inductive or capacitance load to the circuit without ensuring that this will not exceed the permissible voltage and current for the equipment in use.

Only intrinsically safe components can be worked on in the presence of a flammable atmosphere.

The test apparatus shall be of correct rating.

Replace components only with parts specified by the manufacturer. Using other parts may result in ignition of the refrigerant leaked into the atmosphere.

■ **Wiring**

Check that wiring is not subject to wear, corrosion, excessive pressure, vibration, sharp edges or any other adverse environmental effects. The check shall also take into account the effects of ageing or continuous vibration from sources such as compressors or fans.

■ **Detecting of R32**

Under no circumstances shall potential sources of ignition be used in the search for or detection of refrigerant leaks. A halide torch (or any other detector using a naked flame) shall not be used.

Safety Checklist (con't)

■ **Leak detection methods**

The following leak detection methods can be applied for systems containing R32. Electronic leak detectors shall be used to detect R32, but the sensitivity may not be adequate or may need re-calibration (detection equipment shall be calibrated in a refrigerant-free area). Ensure that the detector is not a potential source of ignition and that it is suitable for the refrigerant used. Leak detection equipment shall be set to the percentage of the lower flammability limit (LFL) of the refrigerant and calibrated to fit the refrigerant employed. The appropriate percentage of gas (maximum 25%) shall be confirmed.

Leak detection fluids are suitable for use with most refrigerants but the use of detergents containing chlorine shall be avoided as the chlorine may react with the refrigerant and corrode the copper piping work.

If a leak is suspected, all naked flames shall be removed or extinguished.

If a refrigerant leakage which requires brazing is found, all of the refrigerant shall be recovered from the system, or isolated (by means of shut off valves) in a part of the system remote from the point of the leakage. Oxygen free nitrogen (OFN) shall then be purged through the system both before and during the brazing process.

■ **Removal and evacuation**

When breaking the refrigerant circuit to make repairs or any other purpose, conventional procedures may be used. However, flammability must be taken into consideration. The following procedure shall be adhered to:

- Remove refrigerant;
- Purge the circuit with inert gas;
- Evacuate the inert gas;
- Purge again with inert gas;
- Carry out cutting or brazing of the circuit.

The refrigerant shall be recovered into the correct recovery cylinders. The system shall be cleaned with OFN to render the unit safe. (= Flushing) This process may need to be repeated several times. Compressed air or oxygen shall not be used for this task.

Flushing shall be achieved through breaking the vacuum by filling the system with OFN until the working pressure is achieved, then venting the OFN into the atmosphere, and finally pulling the system down to vacuum again. This process shall be repeated until no refrigerant remains within the system. After the last OFN charge is finished, the system shall be vented down to atmospheric pressure to enable work. This operation is especially important if brazing operations on the piping work are to take place.

Ensure that the outlet for the vacuum pump is not close to any ignition sources and that there is ventilation available.

■ **Charging procedures**

In addition to conventional charging procedures, the following requirements shall be met. Ensure that the charging equipment to be used is not contaminated by different refrigerants. Hoses or lines shall be as short as possible to minimise the amount of refrigerant contained in them.

- Cylinders shall be kept upright.
- Ensure that the refrigeration system is earthed before charging the system with refrigerant.
- Label the system when charging is complete (if not already).
- Extreme care shall be taken not to overfill the refrigeration system.

Before recharging, the system shall be tested for leakage with OFN. On completion of charging, the system shall be tested before commissioning. Follow up leakage test shall be carried out before leaving the site.

Safety Checklist (con't)

■ Decommissioning

Before carrying out this procedure, it is essential that the technician is completely familiar with the equipment and all its details. It is recommended to train technicians so that all of the refrigerant is recovered safely. In case analysis is required before re-using the reclaimed refrigerant, an oil and refrigerant sample shall be taken before proceeding with decommissioning. It is essential that electrical power is available before work.

- (1) Comprehend the equipment and its operation.
- (2) Isolate the system electrically.
- (3) Before starting work, ensure that:
 - ♦ mechanical handling equipment is available if required, for handling refrigerant cylinders;
 - ♦ protective equipment can be used in compliance with specifications;
 - ♦ the recovery process is supervised by a competent person at all times;
 - ♦ recovery equipment and cylinders conform to the appropriate standards.
- (4) Pump down the refrigerant system, if possible.
- (5) If vacuum can not be ensured, apply a manifold so that refrigerant can be removed from various parts of the system.
- (6) Make sure that the cylinder is situated on the scale before recovery takes place.
- (7) Start the refrigerant recovery device and operate it in accordance with the manufacturer's instructions.
- (8) Do not overfill cylinders. (Do not exceed 80% liquid charge volume).
- (9) Do not exceed the maximum working pressure of the cylinder, even temporarily.
- (10) When the cylinders have been filled correctly and the process is completed, make sure that the cylinders and the equipment are removed from site promptly and all valves on the equipment are closed.
- (11) Recovered refrigerant shall not be charged into another refrigeration system before it has been cleaned and checked.

■ Labelling

Equipment shall be labelled stating that it has been decommissioned and emptied of refrigerant. The label shall be dated and signed. Ensure that there are labels on the equipment stating the equipment contains R32.

■ Refrigerant recovery

When removing refrigerant from a system, either for servicing or decommissioning, it is recommended to conduct training so that all refrigerants can be removed safely.

When transferring refrigerant into cylinders, ensure that only appropriate refrigerant recovery cylinders are used.













Ensure that the correct number of cylinders for holding the total system charge are available. All cylinders to be used must be designated for the recovered refrigerant and labelled for that refrigerant (i.e. special cylinders for the recovery of refrigerant). Cylinders shall be equipped with a pressure relief valve and associated shut-off valves in good working order. If possible, empty recovery cylinders shall be cooled in a separate place before recovery is conducted.



The recovery equipment shall be in good working order with instructions concerning the equipment at hand, and shall be suitable for the recovery of R32. In addition, a set of calibrated weighing scales shall be available and in good working order. Hoses shall be equipped with leak-free disconnect couplings and in good condition. Before using the recovery device, check that it has undergone proper maintenance, that it is in satisfactory working order, and that any associated electrical components are sealed to prevent ignition in the event of a refrigerant leakage. Consult manufacturer if in doubt.









The recovered refrigerant shall be returned to the refrigerant supplier in the correct recovery cylinder, with the relevant Waste Transfer Note attached. Do not mix refrigerants in recovery units and especially not in cylinders.

If compressors or compressor oil are to be removed, ensure that the refrigerant melted into the oil has been evacuated to an acceptable level to make certain that R32 does not remain within the oil. The evacuation process shall be carried out before returning the compressor to the supplier. Only electric heating to the compressor body shall be employed to accelerate this process. Oil drained from the system shall be treated safely.

1.2 Warnings and Cautions Regarding Safety of Users





 Warning	
Do not store the equipment in a room with fire sources (e.g., naked flames, gas appliances, electric heaters).	
Be sure to use parts listed in the service parts list of the applicable model and appropriate tools to conduct repair work. Never attempt to modify the equipment. The use of inappropriate parts or tools may cause an electrical shock, excessive heat generation or fire.	
If the power cable and lead wires are scratched or have deteriorated, be sure to replace them. Damaged cable and wires may cause an electrical shock, excessive heat generation or fire.	
Do not use a joined power cable or extension cable, or share the same power outlet with other electrical appliances, since it may cause an electrical shock, excessive heat generation or fire.	
Be sure to use an exclusive power circuit for the equipment, and follow the local technical standards related to the electrical equipment, the internal wiring regulations, and the instruction manual for installation when conducting electrical work. Insufficient power circuit capacity and improper electrical work may cause an electrical shock or fire.	
Be sure to use the specified cable for wiring between the indoor and outdoor units. Make the connections securely and route the cable properly so that there is no force pulling the cable at the connection terminals. Improper connections may cause excessive heat generation or fire.	
When wiring between the indoor and outdoor units, make sure that the terminal cover does not lift off or dismount because of the cable. If the cover is not mounted properly, the terminal connection section may cause an electrical shock, excessive heat generation or fire.	
Do not damage or modify the power cable. Damaged or modified power cables may cause an electrical shock or fire. Placing heavy items on the power cable, or heating or pulling the power cable may damage it.	
Do not mix air or gas other than the specified refrigerant (R32 / R410A / R22) in the refrigerant system. If air enters the refrigerant system, an excessively high pressure results, causing equipment damage and injury.	
If the refrigerant gas leaks, be sure to locate the leaking point and repair it before charging the refrigerant. After charging the refrigerant, make sure that there is no leak. If the leaking point cannot be located and the repair work must be stopped, be sure to pump-down, and close the service valve, to prevent refrigerant gas from leaking into the room. Refrigerant gas itself is harmless, but it may generate toxic gases when it contacts flames, such as those from fan type and other heaters, stoves and ranges.	
When relocating the equipment, make sure that the new installation site has sufficient strength to withstand the weight of the equipment. If the installation site does not have sufficient strength or the installation work is not conducted securely, the equipment may fall and cause injury.	

 Warning	
Check to make sure that the power cable plug is not dirty or loose, then insert the plug into a power outlet securely. If the plug is dusty or has a loose connection, it may cause an electrical shock or fire.	
When replacing the coin battery in the remote controller, be sure to dispose of the old battery to prevent children from swallowing it. If a child swallows the coin battery, see a doctor immediately.	

 Caution	
Installation of a leakage breaker is necessary in some cases depending on the conditions of the installation site, to prevent electrical shocks.	
Do not install the equipment in a place where there is a possibility of combustible gas leaks. If combustible gas leaks and remains around the unit, it may cause a fire.	
Check to see if parts and wires are mounted and connected properly, and if connections at the soldered or crimped terminals are secure. Improper installation and connections may cause excessive heat generation, fire or an electrical shock.	
If the installation platform or frame has corroded, replace it. A corroded installation platform or frame may cause the unit to fall, resulting in injury.	
Check the earth / grounding, and repair it if the equipment is not properly earthed / grounded. Improper earth / grounding may cause an electrical shock.	
Be sure to measure insulation resistance after the repair, and make sure that the resistance is 1 MΩ or higher. Faulty insulation may cause an electrical shock.	
Be sure to check the drainage of the indoor unit after the repair. Faulty drainage may cause water to enter the room and wet the furniture and floor.	
Do not tilt the unit when removing it. The water inside the unit may spill and wet the furniture and floor.	

2. Icons Used

The following icons are used to attract the attention of the reader to specific information.

Icon	Type of Information	Description
 Warning	Warning	Warning is used when there is danger of personal injury.
 Caution	Caution	Caution is used when there is danger that the reader, through incorrect manipulation, may damage equipment, lose data, get an unexpected result or have to restart (part of) a procedure.
 Note	Note	Note provides information that is not indispensable, but may nevertheless be valuable to the reader, such as tips and tricks.
 Reference	Reference	Reference guides the reader to other places in this binder or in this manual, where he/she will find additional information on a specific topic.

3. Revision History

Month/Year	Version	Revised contents
12/2023	DAMA-SM-23-020	First edition

Part 1

General Information

1. Applicable Models13

1. Applicable Models

Model Name and Power Supply

Indoor Unit	Outdoor Unit	Power Supply
FTXC09AXVJU	RXC09AXVJU	1Phase, 208/230V, 60Hz
FTXC12AXVJU	RXC12AXVJU	
FTXC18AXVJU	RXC18AXVJU	
FTXC24AXVJU	RXC24AXVJU	

Nomenclature

Indoor Unit

Definition	Description
Unit Category	F : Air-Cooled Split Indoor Unit
Product Type	T : Wall Mounted
System	X : Inverter, Heatpump
Classification	C : R32, Standard
Capacity Indication*	09 : 9,000 Btu/h
Major Design Category	A : A Series
Factory Origin	X : Malaysia
Power Supply	VJ : 208/230V / 1Phase / 60Hz
Country	U : United States

Outdoor Unit

Definition	Description
Unit Category	R : Air-Cooled Split Outdoor Unit
System	X : Inverter, Heatpump
Classification	C : R32, Standard
Capacity Indication*	09 : 9,000 Btu/h
Major Design Category	A : A Series
Factory Origin	X : Malaysia
Power Supply	VJ : 208/230V / 1Phase / 60Hz
Country	U : United States

Remark:

*Capacity value under Nomenclature is an indication.
Please refer to Specifications for exact capacity value.

Part 2 Specifications

1. Specification Data	16
2. Functions.....	20

1. Specification Data

MODEL	INDOOR UNIT		FTXC09A	
	OUTDOOR UNIT		RXC09A	
			Cooling	Heating
Rated Capacity (Min. ~ Max.)		kW	2.64 (1.30 - 3.00)	2.75 (1.30 - 3.80)
		Btu/h	9000 (4400 - 10200)	9400 (4400 - 13000)
Moisture Removal		gal/h	0.05	
Rated Running Current		A	3.56	3.33
Rated Power Consumption		W	818	765
EER2		Btu/h/W	11.00	N/A
SEER2			18.00	N/A
COP		W/W	N/A	3.60
HSPF2			N/A	9.00
Power Factor (Rated)			N/A	
Piping Connections	Liquid	inch (mm)	1/4" (6.35)	
	Gas	inch (mm)	3/8" (9.52)	
Refrigerant	Type		R32	
	Charge	lbs (kg)	1.65 (0.75)	
Max. Interunit Piping Length		ft (m)	65-5/8 (20)	
Max. Interunit Height Difference		ft (m)	32-13/16 (10)	
Chargeless		ft (m)	32-13/16 (10)	
Amount of Additional Charge of Refrigerant		oz/ft (g/m)	0.18 (17)	
Drawing No.			3D148846	
INDOOR UNIT			FTXC09A	
Front Panel Colour			WHITE	
Airflow Rate	Turbo	CFM	466	
	High	CFM	431	402
	Medium	CFM	322	
	Low	CFM	249	
	Quiet	CFM	142	219
Sound Pressure Level (H/M/L/Q)		dBA	43/36/29/19	42/35/29/25
Fan	Type		CROSS FLOW	
	Drive		DIRECT	
	Speed		3 STEPS, AUTO, QUIET, TURBO	
Fan Motor	Type		DIRECT CURRENT	
	Motor Output	W	22	
	Running Current (Rated)	A	0.10	
	Power Consumption (Rated)	W	29	
Air Direction Control			UP, DOWN, LEFT, RIGHT	
Air Filter			CATECHIN	
Dimensions (H x W x D)		inch (mm)	11-1/3 x 30-5/16 x 9-11/16 (288 x 770 x 246)	
Packaged Dimensions (H x W x D)		inch (mm)	12-3/8 x 32-11/16 x 14-1/16 (314 x 830 x 357)	
Weight		lbs (kg)	19.8 (9.0)	
Gross Weight		lbs (kg)	24.3 (11.0)	
Condensate Drain Size		inch (mm)	5/8 (16)	
Document No.			3D148845	
OUTDOOR UNIT			RXC09A	
Casing Colour			IVORY WHITE	
Airflow Rate	High	CFM	1051	966
Sound Pressure Level		dBA	46	48
Fan	Type		PROPELLER	
	Drive		DIRECT	
Fan Motor	Type		DIRECT CURRENT	
	Index of protection (IP)		24	
	Insulation Grade		E	
	Running Current (Rated)	A	0.61	
	Power Consumption (Rated)	W	46	
	Motor Output	W	26	
Compressor	Poles		8	
	Type		HERMETIC SWING	
	Model		1Y091BKCX1A#G	
	Oil type		DAPHNE FW68DA	
	Oil amount	oz (cm ³)	12.7 (375)	
Heat Exchanger Type			FIN TUBE	
Dimensions (H x W x D)		inch (mm)	21-11/16 x 26-1/2 x 11-3/16 (550 x 675 x 284)	
Packaged Dimensions (H x W x D)		inch (mm)	24-1/64 x 31-3/8 x 15-1/8 (610 x 801 x 384)	
Weight		lbs (kg)	60 (27)	
Gross Weight		lbs (kg)	66 (30)	
Document No.			3D148691	

1) ALL UNITS ARE BEING TESTED ACCORDING TO AHRI 210/240 STANDARD.

2) ALL SPECIFICATIONS ARE SUBJECTED TO CHANGE BY THE MANUFACTURER WITHOUT PRIOR NOTICE.

COOLING		HEATING	
INDOOR: 80°FDB (26.7°CDB) / 67°FWB (19.4°CWB)		INDOOR: 70°FDB (21.1°CDB)	
OUTDOOR: 95°FDB (35°CDB)		OUTDOOR: 47°FDB (8.3°CDB) / 43°FWB(6.1°CWB)	

MODEL	INDOOR UNIT		FTXC12A	
	OUTDOOR UNIT		RXC12A	
			Cooling	Heating
Rated Capacity (Min. ~ Max.)	kW		3.52 (1.30 - 3.90)	3.31 (1.30 - 4.81)
	Btu/h		12000 (4400 - 13300)	11300 (4400 - 16400)
Moisture Removal	gal/h		0.16	
Rated Running Current	A		6.14	4.36
Rated Power Consumption	W		1412	1004
EER2	Btu/h/W		8.50	N/A
SEER2			18.00	N/A
COP	W/W		N/A	3.30
HSPF2			N/A	9.00
Power Factor (Rated)			N/A	
Piping Connections	Liquid	inch (mm)	1/4" (6.35)	
	Gas	inch (mm)	3/8" (9.52)	
Refrigerant	Type		R32	
	Charge	lbs (kg)	1.65 (0.75)	
Max. Interunit Piping Length	ft (m)		65-5/8 (20)	
Max. Interunit Height Difference	ft (m)		32-13/16 (10)	
Chargeless	ft (m)		32-13/16 (10)	
Amount of Additional Charge of Refrigerant	oz/ft (g/m)		0.18 (17)	
Drawing No.			3D148846	
INDOOR UNIT			FTXC12A	
Front Panel Colour			WHITE	
Airflow Rate	Turbo	CFM	473	
	High	CFM	436	412
	Medium	CFM	316	
	Low	CFM	247	
	Quiet	CFM	132	210
Sound Pressure Level (H/M/L/Q)	dBA		45/37/31/19	43/36/30/26
Fan	Type		CROSS FLOW	
	Drive		DIRECT	
	Speed		3 STEPS, AUTO, QUIET, TURBO	
Fan Motor	Type		DIRECT CURRENT	
	Motor Output	W	22	
	Running Current (Rated)	A	0.10	
	Power Consumption (Rated)	W	29	
Air Direction Control			UP, DOWN, LEFT, RIGHT	
Air Filter			CATECHIN	
Dimensions (H x W x D)		inch (mm)	11-1/3 x 30-5/16 x 9-11/16 (288 x 770 x 246)	
Packaged Dimensions (H x W x D)		inch (mm)	12-3/8 x 32-11/16 x 14-1/16 (314 x 830 x 357)	
Weight		lbs (kg)	20.9 (9.5)	
Gross Weight		lbs (kg)	25.4 (11.5)	
Condensate Drain Size		inch (mm)	5/8 (16)	
Document No.			3D148845	
OUTDOOR UNIT			RXC12A	
Casing Colour			IVORY WHITE	
Airflow Rate	High	CFM	1051	966
Sound Pressure Level		dBA	48	
Fan	Type		PROPELLER	
	Drive		DIRECT	
Fan Motor	Type		DIRECT CURRENT	
	Index of protection (IP)		24	
	Insulation Grade		E	
	Running Current (Rated)	A	0.61	
	Power Consumption (Rated)	W	46	
	Motor Output	W	26	
	Poles		8	
Compressor	Type		HERMETIC SWING	
	Model		1Y091BKCX1A#G	
	Oil type		DAPHNE FW68DA	
	Oil amount	oz (cm³)	12.7 (375)	
Heat Exchanger Type			FIN TUBE	
Dimensions (H x W x D)		inch (mm)	21-11/16 x 26-1/2 x 11-3/16 (550 x 675 x 284)	
Packaged Dimensions (H x W x D)		inch (mm)	24-1/64 x 31-3/8 x 15-1/8 (610 x 801 x 384)	
Weight		lbs (kg)	60 (27)	
Gross Weight		lbs (kg)	66 (30)	
Document No.			3D148691	

1) ALL UNITS ARE BEING TESTED ACCORDING TO AHRI 210/240 STANDARD.

2) ALL SPECIFICATIONS ARE SUBJECTED TO CHANGE BY THE MANUFACTURER WITHOUT PRIOR NOTICE.

COOLING	HEATING
INDOOR: 80°FDB (26.7°CDB) / 67°FWB (19.4°CWB)	INDOOR: 70°FDB (21.1°CDB)
OUTDOOR: 95°FDB (35°CDB)	OUTDOOR: 47°FDB (8.3°CDB) / 43°FWB (6.1°CWB)

MODEL	INDOOR UNIT		FTXC18A	
	OUTDOOR UNIT		RXC18A	
			Cooling	Heating
Rated Capacity (Min. ~ Max.)	kW		5.30 (2.02 - 5.86)	5.28 (1.70 - 6.60)
	Btu/h		18100 (6900 - 20000)	18000 (5800 - 22500)
Moisture Removal	gal/h		0.61	
Rated Running Current	A		7.49	6.95
Rated Power Consumption	W		1724	1599
EER2	Btu/h/W		10.50	N/A
SEER2			18.00	N/A
COP	W/W		N/A	3.30
HSPF2			N/A	9.00
Power Factor (Rated)			N/A	
Piping Connections	Liquid	inch (mm)	1/4" (6.35)	
	Gas	inch (mm)	1/2" (12.70)	
Refrigerant	Type		R32	
	Charge	lbs (kg)	3.31 (1.50)	
Max. Interunit Piping Length	ft (m)		98-1/2 (30)	
Max. Interunit Height Difference	ft (m)		32-13/16 (10)	
Chargeless	ft (m)		32-13/16 (10)	
Amount of Additional Charge of Refrigerant	oz/ft (g/m)		0.18 (17)	
Drawing No.			3D148846	
INDOOR UNIT			FTXC18A	
Front Panel Colour			WHITE	
Airflow Rate	Turbo	CFM	754	
	High	CFM	716	
	Medium	CFM	605	
	Low	CFM	467	
	Quiet	CFM	395	
Sound Pressure Level (H/M/L/Q)		dBA	48/43/37/33	46/41/36/33
Fan	Type		CROSS FLOW	
	Drive		DIRECT	
	Speed		3 STEPS, AUTO, QUIET, TURBO	
Fan Motor	Type		DIRECT CURRENT	
	Motor Output	W	39	
	Running Current (Rated)	A	0.17	
	Power Consumption (Rated)	W	54	
Air Direction Control			UP, DOWN, LEFT, RIGHT	
Air Filter			CATECHIN	
Dimensions (H x W x D)		inch (mm)	11-11/16 x 39-9/16 x 11-1/3 (297 x 990 x 288)	
Packaged Dimensions (H x W x D)		inch (mm)	14-3/4 x 14-5/8 x 42-1/4 (375 x 371 x 1073)	
Weight		lbs (kg)	30.5 (13.8)	
Gross Weight		lbs (kg)	36 (16.5)	
Condensate Drain Size		inch (mm)	5/8 (16)	
Document No.			3D148845	
OUTDOOR UNIT			RXC18A	
Casing Colour			IVORY WHITE	
Airflow Rate	High	CFM	1879	1833
Sound Pressure Level		dBA	53	
Fan	Type		PROPELLER	
	Drive		DIRECT	
Fan Motor	Type		DIRECT CURRENT	
	Index of protection (IP)		23	
	Insulation Grade		E	
	Running Current (Rated)	A	1.30	
	Power Consumption (Rated)	W	85	
	Motor Output	W	55	
Compressor			8	
Compressor	Type		HERMETIC SWING	
	Model		2Y147BKBX1A#A	
	Oil type		DAPHNE FW68DA	
	Oil amount	oz (cm³)	22.0 (650)	
Heat Exchanger Type			FIN TUBE	
Dimensions (H x W x D)		inch (mm)	27-13/32 x 36-5/8 x 13-13/16 (696 x 930 x 351)	
Packaged Dimensions (H x W x D)		inch (mm)	29-7/8 x 42-3/8 x 18-7/8 (760 x 1075 x 480)	
Weight		lbs (kg)	101 (46)	
Gross Weight		lbs (kg)	110 (50)	
Document No.			3D148691	

1) ALL UNITS ARE BEING TESTED ACCORDING TO AHRI 210/240 STANDARD.

2) ALL SPECIFICATIONS ARE SUBJECTED TO CHANGE BY THE MANUFACTURER WITHOUT PRIOR NOTICE.

COOLING	HEATING
INDOOR: 80°FDB (26.7°CDB) / 67°FWB (19.4°CWB)	INDOOR: 70°FDB (21.1°CDB)
OUTDOOR: 95°FDB (35°CDB)	OUTDOOR: 47°FDB (8.3°CDB) / 43°FWB (6.1°CWB)

MODEL	INDOOR UNIT		FTXC24A	
	OUTDOOR UNIT		RXC24A	
			Cooling	Heating
Rated Capacity (Min. ~ Max.)	kW		6.57 (2.02 - 7.09)	6.74 (1.70 - 8.00)
	Btu/h		22400 (6900 - 24200)	23000 (5800 - 27300)
Moisture Removal	gal/h		0.88	
Rated Running Current	A		9.28	8.62
Rated Power Consumption	W		2133	1983
EER2	Btu/h/W		10.50	N/A
SEER2			18.00	N/A
COP	W/W		N/A	3.40
HSPF2			N/A	9.00
Power Factor (Rated)			N/A	
Piping Connections	Liquid	inch (mm)	1/4" (6.35)	
	Gas	inch (mm)	5/8" (15.88)	
Refrigerant	Type		R32	
	Charge	lbs (kg)	3.31 (1.50)	
Max. Interunit Piping Length	ft (m)		98-1/2 (30)	
Max. Interunit Height Difference	ft (m)		32-13/16 (10)	
Chargeless	ft (m)		32-13/16 (10)	
Amount of Additional Charge of Refrigerant	oz/ft (g/m)		0.18 (17)	
Drawing No.			3D148846	
INDOOR UNIT			FTXC24A	
Front Panel Colour			WHITE	
Airflow Rate	Turbo	CFM	754	
	High	CFM	716	
	Medium	CFM	605	
	Low	CFM	467	
	Quiet	CFM	395	
Sound Pressure Level (H/M/L/Q)	dBA		51/44/38/34	48/42/37/34
Fan	Type		CROSS FLOW	
	Drive		DIRECT	
	Speed		3 STEPS, AUTO, QUIET, TURBO	
Fan Motor	Type		DIRECT CURRENT	
	Motor Output	W	39	
	Running Current (Rated)	A	0.17	
	Power Consumption (Rated)	W	54	
Air Direction Control			UP, DOWN, LEFT, RIGHT	
Air Filter			CATECHIN	
Dimensions (H x W x D)	inch (mm)		11-11/16 x 39-9/16 x 11-1/3 (297 x 990 x 288)	
Packaged Dimensions (H x W x D)	inch (mm)		14-3/4 x 14-5/8 x 42-1/4 (375 x 371 x 1073)	
Weight	lbs (kg)		30.5 (13.8)	
Gross Weight	lbs (kg)		36 (16.5)	
Condensate Drain Size	inch (mm)		5/8 (16)	
Document No.			3D148845	
OUTDOOR UNIT			RXC24A	
Casing Colour			IVORY WHITE	
Airflow Rate	High	CFM	1879	1833
Sound Pressure Level		dBA	53	52
Fan	Type		PROPELLER	
	Drive		DIRECT	
Fan Motor	Type		DIRECT CURRENT	
	Index of protection (IP)		23	
	Insulation Grade		E	
	Running Current (Rated)	A	1.30	
	Power Consumption (Rated)	W	88	
	Motor Output	W	55	
	Poles		8	
Compressor	Type		HERMETIC SWING	
	Model		2Y147BKBX1A#A	
	Oil type		DAPHNE FW68DA	
	Oil amount	oz (cm³)	22.0 (650)	
Heat Exchanger Type			FIN TUBE	
Dimensions (H x W x D)	inch (mm)		27-13/32 x 36-5/8 x 13-13/16 (696 x 930 x 351)	
Packaged Dimensions (H x W x D)	inch (mm)		29-7/8 x 42-3/8 x 18-7/8 (760 x 1075 x 480)	
Weight	lbs (kg)		101 (46)	
Gross Weight	lbs (kg)		110 (50)	
Document No.			3D148691	

1) ALL UNITS ARE BEING TESTED ACCORDING TO AHRI 210/240 STANDARD.

2) ALL SPECIFICATIONS ARE SUBJECTED TO CHANGE BY THE MANUFACTURER WITHOUT PRIOR NOTICE.

COOLING	HEATING
INDOOR: 80°FDB (26.7°CDB) / 67°FWB (19.4°CWB)	INDOOR: 70°FDB (21.1°CDB)
OUTDOOR: 95°FDB (35°CDB)	OUTDOOR: 47°FDB (8.3°CDB) / 43°FWB (6.1°CWB)

2. Functions

Category	Functions	FTXC09/12A RXC09/12A	FTXC18/24A RXC18/24A
Basic Function	Inverter		●
	Operation Limit for Cooling (°CDB)(O/D)		10 ~ 46
	Operation Limit for Cooling (°FDB)(O/D)		50 ~ 114.8
	Operation Limit for Heating (°CWB)(O/D)		-15 ~ 18
	Operation Limit for Heating (°FWB)(O/D)		5 ~ 64.4
Compressor	Scroll Compressor		—
	Rotary Compressor		—
	Swing Compressor		●
Comfortable Airflow	Power-airflow Flap	●	—
	Power-airflow Dual Flaps	—	●
	Power-airflow Diffuser		—
	Wide Angle Louvers		●
	Vertical Auto-Swing (Up and Down)		●
	Horizontal Auto-Swing (Right and Left)		—
	3D Airflow		—
	Breeze Airflow		—
Comfort Control	Auto Fan Speed		●
	Indoor Unit Quiet Operation		●
	Intelligent Eye Operation		—
	Automatic Defrosting		●
Operation	Automatic Operation		●
	Programme Dry Function		●
	Fan Only		●
Lifestyle Convenience	Powerful Operation (Non Inverter)		—
	Inverter Powerful Operation		●
	Energy Saving Function		●
	Sleep Mode		●
	Indoor Unit ON/OFF Button		●
	R/C with Backlight		●
	Signal Receiving Sign (R/C)		●
	Set Temperature Display (R/C)		●
Health & Clean	Saranet Filter		—
	GIN-ION Filter		—
	Catechin Filter / Green Tea Filter		●
	Titanium Apatite Air-Purifying Filter		●
	Enzyme Blue Deodorizing Filter		—
	PM 2.5 Filter		—
	Streamer		—
	Plasma		—
	Wipe Clean Flat Panel		●
	Coil Clean (by APP control)		—
Timer	Weekly Timer Operation (Wired R/C)		—
	24-hour ON/OFF Timer (R/C)		●
	Countdown ON/OFF Timer (R/C)		—
Worry Free (Reliability & Durability)	Auto Restart (after Power Failure)		●
	Self-diagnosis		●
	Anti-corrosion Treatment of Outdoor Heat Exchanger		Blue Fin
	Low/High Voltage Shield (PCB Level / Unit Level)		—
Flexibility	Pre-charged Piping Length		32-13/16 ft
	Either Side Drain (Right or Left)		●
	Detachable Drain Pan		●
	Low ambient cooling operation (-15°C) (5°F)		—
Remote Control	Wireless LAN Connectivity		●*
	BAG Connectivity		●*
	iTM Connectivity		—
	DIII-NET Connectivity		—
Remote Controller	Wireless		BRC52B63
	Wired (Optional)		BRC51D61

Note: ● : Available
 — : Not available
 ●* : Optional (Refer to DAMA Spare Part team for more details on optional items.)

Part 3

Functions and Control

1. Main Functions	22
1.1 Temperature Control	22
1.2 Frequency Control	22
1.3 Airflow Direction Control	24
1.4 Fan Speed Control for Indoor Unit	24
1.5 Dry Mode	25
1.6 Automatic Operation	26
1.7 Thermostat Control	27
1.8 ECO+ Operation	28
1.9 Sleep Mode	29
1.10 POWERFUL Operation	29
1.11 Other Functions	30
2. Thermistor Functions	31
3. Control Specification	32
3.1 Mode Hierarchy	32
3.2 Frequency Control	33
3.3 Standby Electricity Saving (Suspend Function)	35
3.4 Controls at Mode Changing/Start-up	35
3.5 Discharge Pipe Temperature Control	37
3.6 Input Current Control	38
3.7 Freeze-up Protection Control	39
3.8 Heating Peak-cut Control	40
3.9 Outdoor Fan Control	41
3.10 Liquid Compression Protection Function	42
3.11 Defrost Control	42
3.12 Electronic Expansion Valve Control	43
3.13 Malfunctions	47

1. Main Functions

1.1 Temperature Control

Definitions of Temperatures

The definitions of temperatures are classified as following.

- Room temperature: temperature of lower part of the room
- Set temperature: temperature set by remote controller
- Room thermistor temperature: temperature detected by room temperature thermistor
- Target temperature: temperature determined by microcomputer

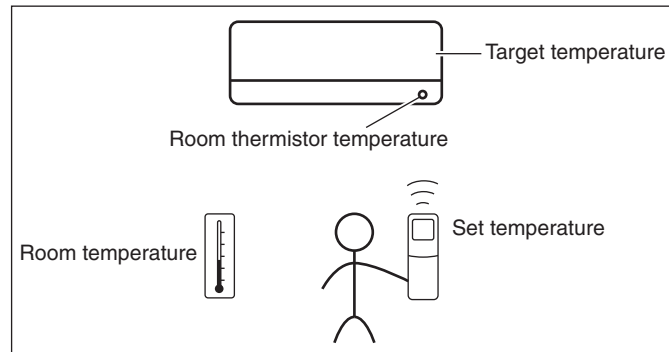

Temperature Control

The temperature of the room is detected by the room temperature thermistor. However, there is a difference between the temperature detected by room temperature thermistor and the temperature of lower part of the room, depending on the type of the indoor unit or installation condition. In practice, the temperature control is done by the target temperature appropriately adjusted for the indoor unit and the temperature detected by room temperature thermistor.

1.2 Frequency Control

Control Parameters

The frequency of the compressor is controlled by the following 2 parameters:

- The load condition of the operating indoor unit
- The difference between the room thermistor temperature and the target temperature

The target frequency is adapted by additional parameters in the following cases:

- Frequency restrictions
- Initial settings
- Forced cooling operation

Inverter Principle

To regulate the capacity, a frequency control is needed. The inverter makes it possible to control the rotation speed of the compressor. The following explain the inverter principle:

Phase 1

The supplied AC power source is converted into the DC power source for the present.

Phase 2

The DC power source is reconverted into the three phase AC power source with variable frequency.

- When the frequency increases, the rotation speed of the compressor increases resulting in an increase of refrigerant circulation. This leads to a larger amount of heat exchange per unit.
- When the frequency decreases, the rotation speed of the compressor decreases resulting in a decrease of refrigerant circulation. This leads to a smaller amount of heat exchange per unit.

The following drawing shows a schematic view of the inverter principle:

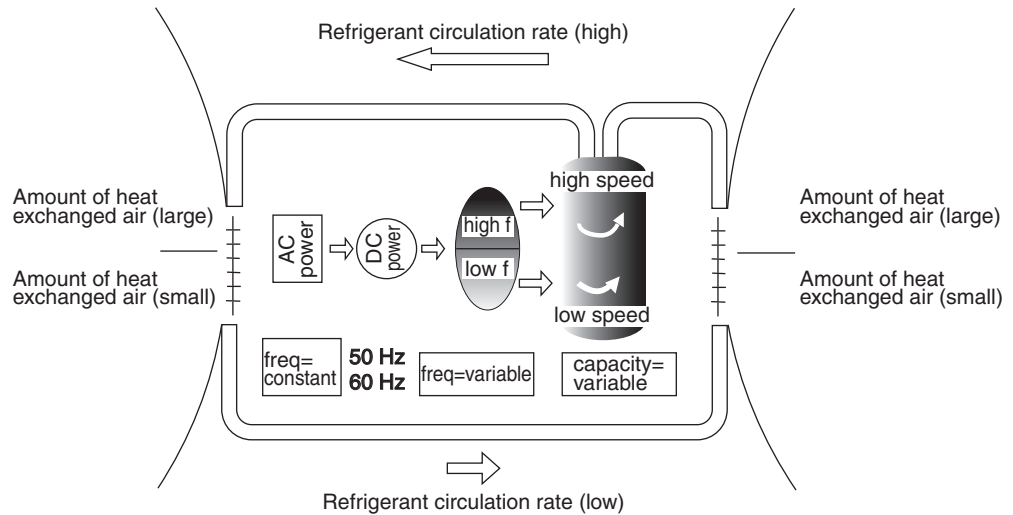

Inverter Features

The inverter provides the following features:

- The regulating capacity can be changed according to the changes in the outdoor temperature and cooling load.
- Quick cooling
The rotation speed of the compressor is increased when starting the cooling. This enables to reach the set temperature quickly.
- Comfortable air conditioning
A fine adjustment is integrated to keep the room temperature constant.
- Energy saving cooling
Once the set temperature is reached, the energy saving operation enables to maintain the room temperature at low power.

Frequency Limits

The following functions regulate the minimum and maximum frequency:

- Compressor protection function. Refer to page 35.
- Discharge pipe temperature control. Refer to page 37.
- Input current control. Refer to page 38.
- Freeze-up protection control. Refer to page 39.

Forced Cooling Operation

Refer to page 105 for details.

1.3 Airflow Direction Control

Power-Airflow Flap

The large flap sends a large volume of air downward to the floor and provides an optimum control in cooling and dry operation.

Cooling/Dry

During cooling or dry operation, the flap retracts into the indoor unit. Then, cool air can be blown far and distributed all over the room.

Wide-Angle Louvers

The louvers, made of elastic synthetic resin, provide a wide range of airflow that guarantees comfortable air distribution.

Auto-Swing

The followings explain the auto-swing process for cooling, dry and fan:

Class	Cooling / Dry / Fan (A-B)	Heating (A - B)
09/12	40 - 65	45 - 90
18/24	45 - 70	

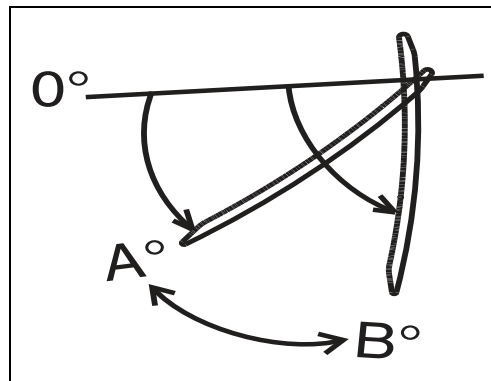

1.4 Fan Speed Control for Indoor Unit

FTXB Outline

Phase control and fan speed control contains 5 steps: SL, L, M, H, SH. The airflow rate can be automatically controlled depending on the difference between the room thermistor temperature and the set temperature.

In heating mode, the indoor fan speed will be regulated according to the indoor heat exchanger temperature and the difference between the room temperature and the required set temperature.

Automatic Fan Speed Control

In automatic fan speed operation, the step SL, & SH is not available.

Step	Cooling	Heating
L	↕	↕
M		
H		

↕ = The airflow rate is automatically controlled within this range when **FAN** setting button is set to automatic.

Series	Class	SL	L	M	H	SH
FTXB Series	09	142(C); 219(H)	249	322	431(C) 402(H)	466
	12	132(C); 210(H)	247	316	436(C) 412 (H)	473
	18	395	467	605	716	754
	24	395	467	605	716	754

Cooling

The following drawings explain the principle of fan speed control for cooling.

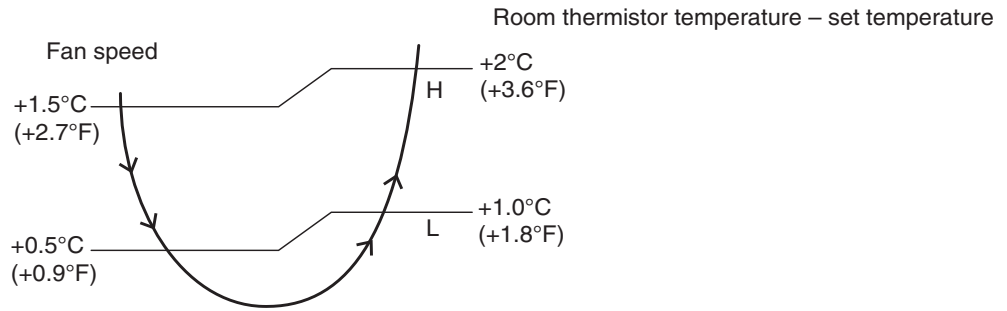

Heating

The following drawings explain the principle of fan speed control for heating.

On heating mode, the indoor fan speed will be regulated according to the heat exchanger temperature and the difference between the room temperature and the required target temperature.

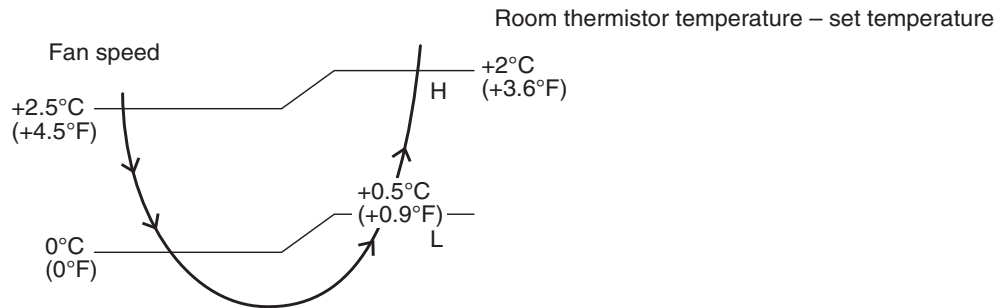

1.5 Dry Mode

Outline

Program dry operation removes humidity. Since the microcomputer controls the airflow rate, the FAN setting buttons are inoperable.

Details

The microcomputer automatically sets the airflow rate. The difference between the room thermistor temperature and the set temperature is divided into zones. Then, the unit operates in an appropriate capacity for each zone to maintain the temperature and humidity at a comfortable level. Zone B continues to stay for 120 seconds before the unit will turn to thermostat ON.

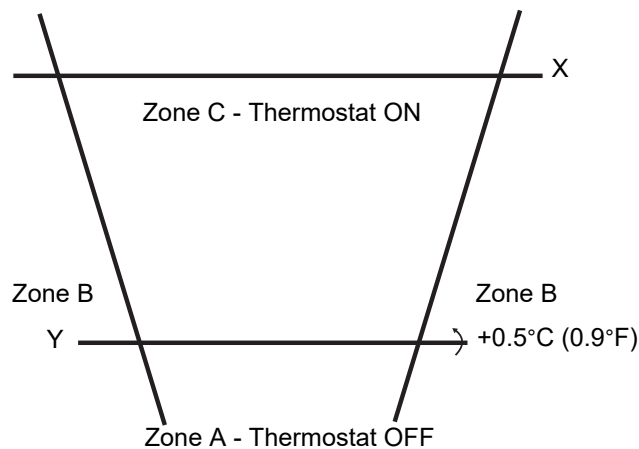

Target temperature X	Thermostat OFF point Y	Thermostat ON point Y
Setting temperature	Room thermistor temperature - X = (< -1.5° C) or (< -2.7° F)	Room thermistor temperature - X = (≥ -1.5° C) or (≥ -2.7° F)

1.6 Automatic Operation

Automatic Cooling / Heating Function (Heat Pump Only)

When the AUTO mode is selected with the remote controller, the microcomputer automatically determines the operation mode from cooling and heating according to the room temperature and setting temperature at the time of the operation startup, and automatically operates in that mode.

The unit automatically switches the operation mode to cooling or heating to maintain the room temperature at the main unit setting temperature.

Details

Explanation of the Function

1. Remote controller setting temperature is set as automatic cooling / heating setting temperature 16°C (60°F) to 30°C (86°F).
2. Main unit setting temperature equals remote controller setting temperature.
3. Operation ON / OFF point and mode switching point are as follows.
 - ① Heating → Cooling switching point:
Room temperature \geq Main unit setting temperature +2.5 deg (+4.5°F).
 - ② Cooling → Heating switching point:
Room temperature $<$ Main unit setting temperature -2.5 deg (-4.5°F)
 - ③ Thermostat ON / OFF point is the same as the ON / OFF point of cooling or heating operation.
4. During initial operation
Room temperature \geq Remote controller setting temperature: Cooling operation
Room temperature $<$ Remote controller setting temperature: Heating operation

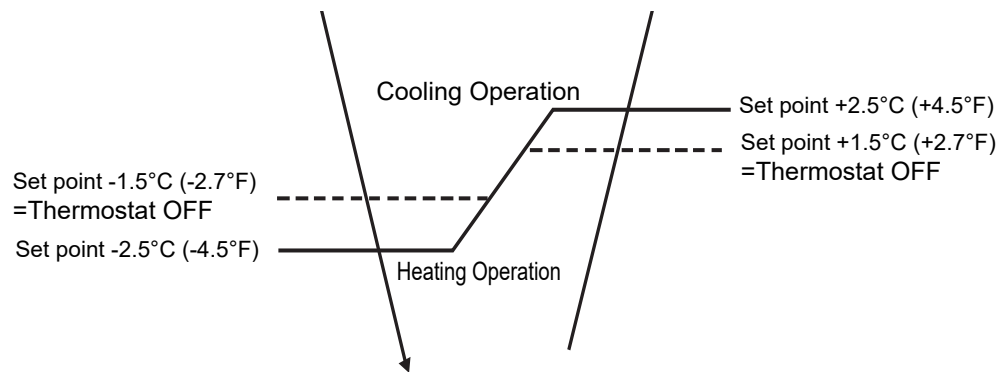

Ex : When the set temperature is 25°C (77°F),

Scenario 1 Thermostat OFF → 23.5°C (74.3°F). If room temperature continues to drop to 22.5°C (72.5°F) :

- Switch from Cooling Operation to Heating Operation

Scenario 2 Room temperature maintains at 25°C (77°F) :

- No Switch in Operation mode

Scenario 3 Thermostat OFF → 26.5°C (79.7°F). If room temperature continues to increase to 27.5°C (81.5°F) :

- Switch from Heating Operation to Cooling Operation

1.7 Thermostat Control

Outline Thermostat control is based on the difference between the room thermistor temperature and the set temperature.

Details

Thermostat OFF Conditions

- The temperature difference is in the zone A.

Thermostat ON Conditions

- The temperature difference returns to the zone C after being in the zone A.
- The operation turns on in any zones except A.
- The monitoring time has passed while the temperature difference is in the zone B. (Cooling/Dry/Heating: 2 minutes)

Cooling/Dry

Room thermistor temperature – set temperature

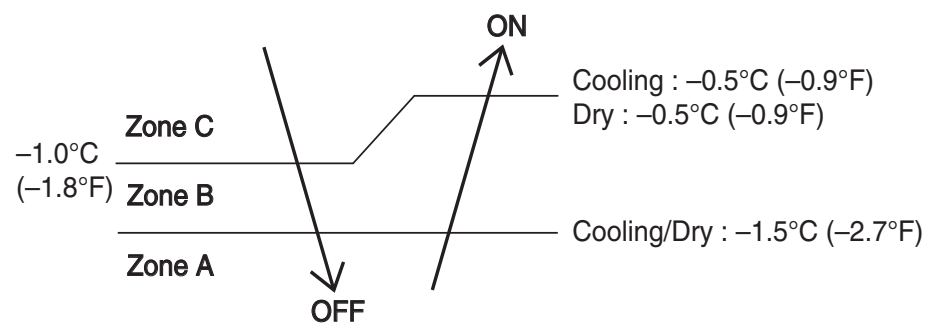

Heating

Room temperature – set temperature

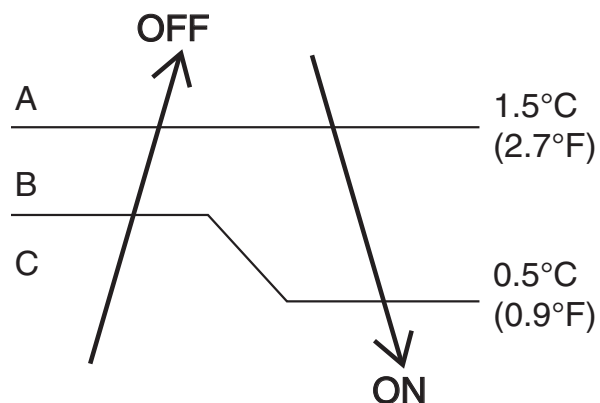

1.8 ECO+ Operation

Outline

ECO+ operation reduces the maximum operating power input and adjust the target temperature setting. This operation is particularly convenient for energy-saving. It is also a major bonus when breaker capacity does not allow the use of multiple electrical devices and air conditioners. It can be easily activated by pressing ECO+ button on the wireless remote controller.

Details

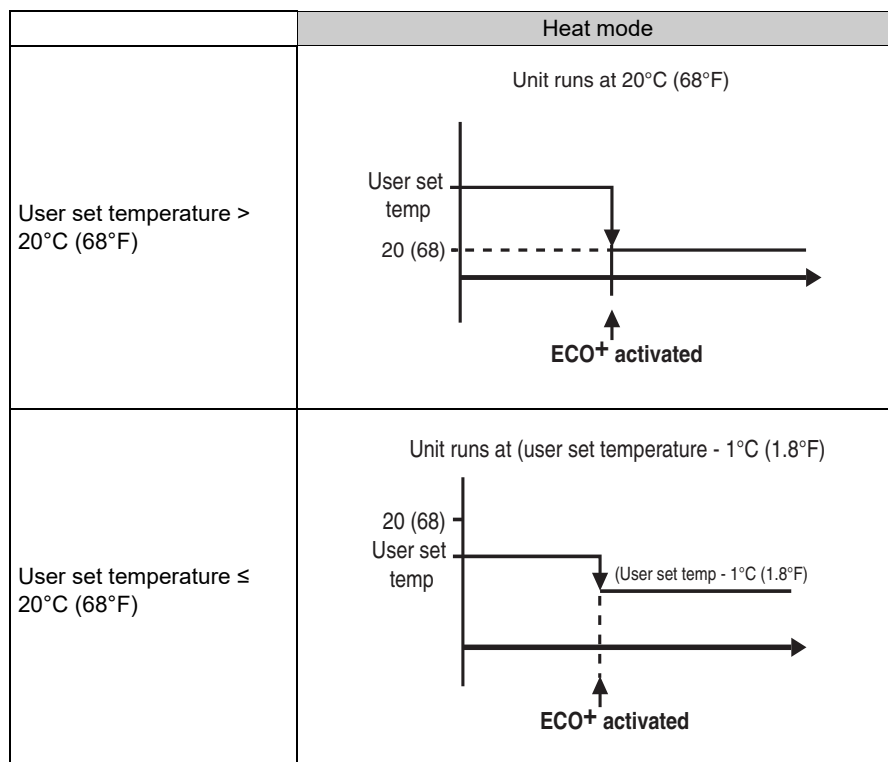
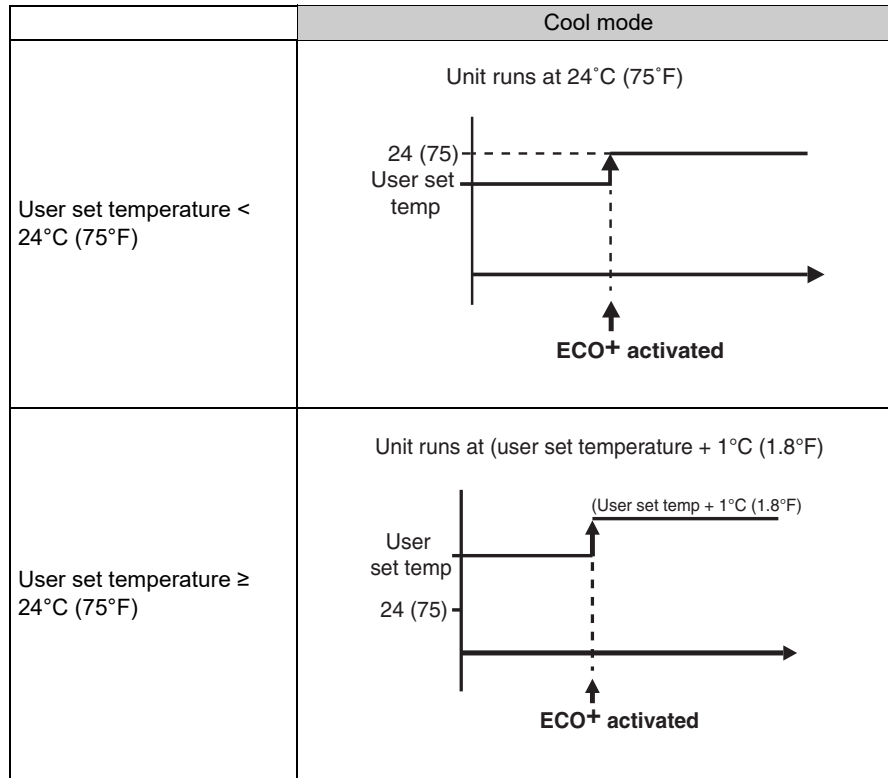

1.9 Sleep Mode

Outline SLEEP Mode can be activated through the remote controller to keep the thermal comfort while sleeping.

Details SLEEP Mode continues operation at the target temperature for the first hour, then automatically raises the target temperature slightly in case of cooling, or lowers it slightly in case of heating. This prevents excessive cooling in summer and excessive heating in winter to ensure comfortable sleeping conditions and also saves electricity.

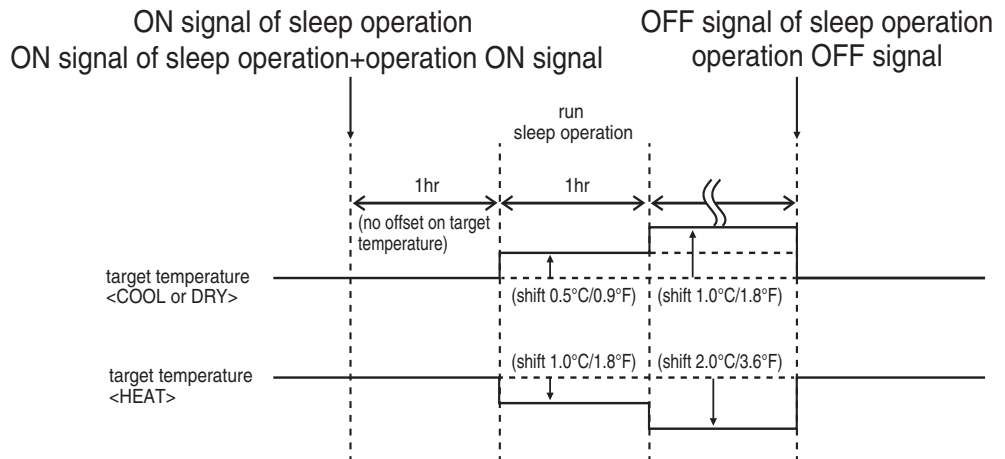

1.10 POWERFUL Operation

Outline In order to exploit the cooling capacity to full extent, the air conditioner can be operated by increasing the indoor fan rotating speed and the compressor frequency.

Details When **POWERFUL** button is pressed, the fan speed and target temperature are converted to the following states for 20 minutes.

Operation mode	Fan speed	Target temperature
COOL	H tap + A rpm	Setting temperature -4°C (-7.2°F)
HEAT	H tap + A rpm	Setting temperature +6°C (+10.8°F)

H = high fan
A = refer table below

		Class			
		09	12	18	24
Model	Mode	A			
FTXB	Cool	80	90	80	80
	Heat	150	150	80	80



Note

POWERFUL operation cannot be used together with ECO+ operation.

1.11 Other Functions

1.11.1 Signal Receiving Sign

When the indoor unit receives a signal from the remote controller, the unit emits a signal receiving sound.

1.11.2 Indoor Unit ON/OFF Switch

Indoor unit **ON/OFF** switch is provided on the display of the unit.

- Press **ON/OFF** switch once to start operation. Press once again to stop it.
- **ON/OFF** switch is useful when the remote controller is missing or the battery has run out.
- The operation mode refers to the following table.

	Operation mode	Temperature setting	Airflow rate
FTXB Series	AUTO	25°C (77°F)	Automatic

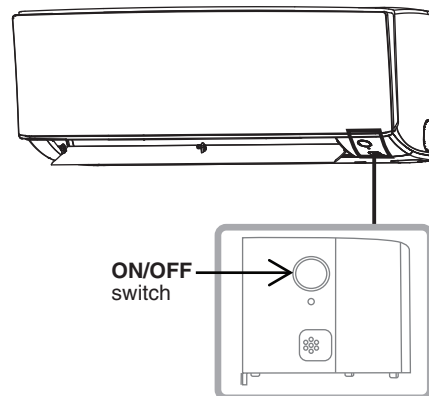

Forced Cooling Operation

Forced cooling operation can be started by pressing **ON/OFF** switch for 5 ~ 9 seconds while the unit is not operating.

Refer to page 105 for details.



Note

Forced cooling operation will not be started if the **ON/OFF** switch is pressed for 10 seconds or more.

1.11.3 Auto-restart Function

If a power failure (even a momentary one) occurs during the operation, the operation restarts automatically in the same conditions as before when the power supply is restored to the conditions prior to the power failure.



Note

It takes 3 minutes to restart the operation because 3-minute standby function is activated.

1.11.4 Hot-start function

In order to prevent the cold air blast that normally comes when heating is started, the temperature of the heat exchanger of the indoor is detected, and either the airflow is stopped or is made very weak thereby carrying out comfortable heating of the room.



Note

*The cold air blast is also prevented using a similar control when the defrosting operation is started or when the thermostat gets turned ON.

2. Thermistor Functions

(A)FTXB series only

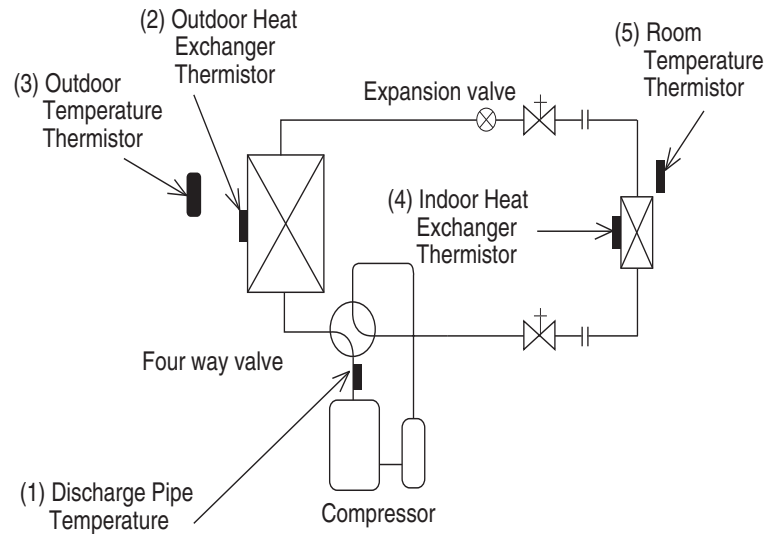

(1) Discharge Pipe Thermistor

- The discharge pipe thermistor is used for controlling discharge pipe temperature. If the discharge pipe temperature (used in place of the inner temperature of the compressor) rises abnormally, the operating frequency becomes lower or the operation halts.
- The discharge pipe thermistor is used for detecting disconnection of the discharge pipe thermistor.

(2) Outdoor Heat Exchanger Thermistor

- The outdoor heat exchanger thermistor is used for controlling the target discharge pipe temperature. The system sets the target discharge pipe temperature according to the outdoor and indoor heat exchanger temperature, and controls the electronic expansion valve opening so that the target discharge pipe temperature can be obtained.
- In cooling operation, the outdoor heat exchanger thermistor is used for detecting the disconnection of the discharge pipe thermistor. When the discharge pipe temperature drops below the outdoor heat exchanger temperature by more than a certain value, the discharge pipe thermistor is judged as disconnected.
- In cooling operation, the outdoor heat exchanger thermistor is used for high pressure protection.

(3) Outdoor Temperature Thermistor

- The outdoor temperature thermistor detects the outdoor air temperature and is used for refrigerant shortage detection, input current control, outdoor fan control, liquid compression protection function, and so on.

(4) Indoor Heat Exchanger Thermistor

- The indoor heat exchanger thermistor is used for controlling the target discharge pipe temperature. The system sets the target discharge pipe temperature according to the outdoor and indoor heat exchanger temperature, and controls the electronic expansion valve opening so that the target discharge pipe temperature can be obtained.
- In cooling operation, the indoor heat exchanger thermistor is used for freeze-up protection control. If the indoor heat exchanger temperature drops abnormally, the operating frequency becomes lower or the operation halts.
- During heating, the indoor heat exchanger thermistor is used for detecting disconnection of the discharge pipe thermistor. When the discharge pipe temperature becomes lower than the indoor heat exchanger temperature, the discharge pipe thermistor is judged as disconnected. The indoor heat exchanger thermistor is also used for preventing abnormal high pressure.

(5) Room Temperature Thermistor

- The room temperature thermistor detects the room air temperature and is used for controlling the room air temperature.

3. Control Specification

3.1 Mode Hierarchy

Outline The air conditioner control has normal operation mode, forced operation mode, and power transistor test mode for installation and servicing.

Details Applicable for FTXB series.
 There are following modes; Fan, Cooling (includes drying), Stop.

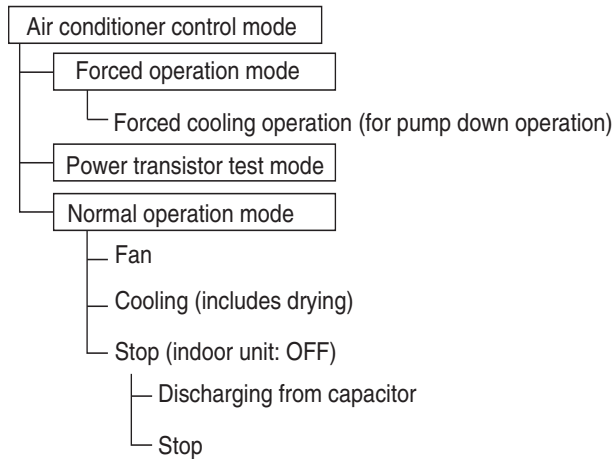

Applicable for FTX series.
 There are following modes; Cooling (includes drying), Heating (includes defrosting), Stop.

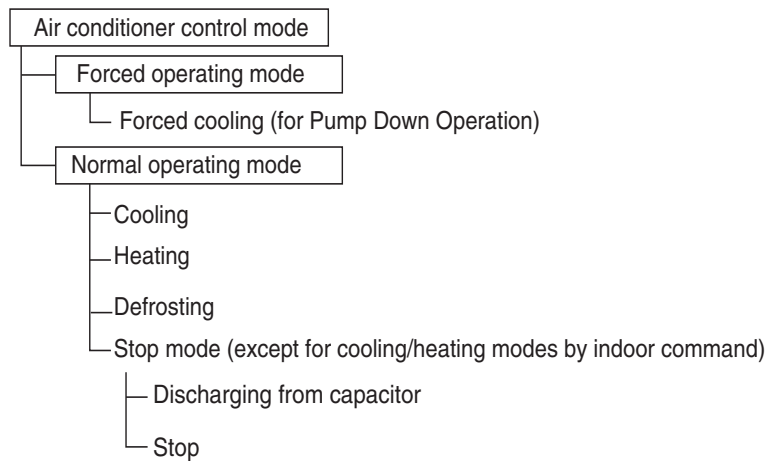

i Note Unless specified otherwise, dry operation command is regarded as cooling operation.

3.2 Frequency Control

Outline

The compressor frequency is determined according to the difference between the room thermistor temperature and the target temperature.

When the shift of the frequency is less than zero ($\Delta F < 0$) by PI control, the target frequency is used as the command frequency.

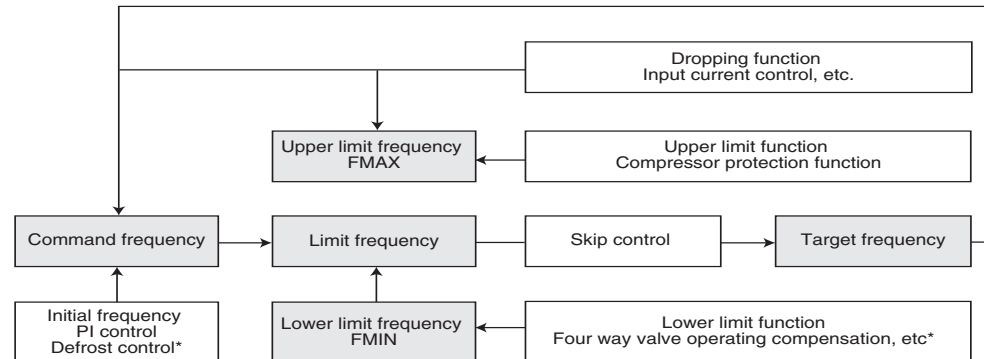

*Only applicable for heat-pump model

Details

For Cooling Only model:

1. Determine command frequency

Command frequency is determined in the following order of priority.

- (1) Forced cooling
- (2) Indoor frequency command

2. Determine upper limit frequency

The minimum value is set as the upper limit frequency among the frequency upper limits of the following functions:

Compressor protection, input current, discharge pipe temperature, freeze-up protection.

3. Determine lower limit frequency

The maximum value is set as the lower limit frequency among the frequency lower limits of the following function:

Pressure difference upkeep.

4. Determine prohibited frequency

There is a certain prohibited frequency such as a power supply frequency.

For Heat-pump model:

1. Determine command frequency

- ◆ Command frequency will be determined in the following order of priority.
 - 1.1 Limiting frequency by drooping function
 - ◆ Input current, discharge pipes, peak cutting, freeze-up protection, dew prevention, fin thermistor temperature.
 - 1.2 Limiting defrost control time
 - 1.3 Forced cooling
 - 1.4 Indoor frequency command

2. Determine upper limit frequency

- ◆ Set a minimum value as an upper limit frequency among the frequency upper limits of the following functions:
Compressor protection, input current, discharge pipes, peak cutting, freeze-up protection, defrost.

3. Determine lower limit frequency

- ◆ Set a maximum value as an lower limit frequency among the frequency lower limits of the following functions:
Four way valve operating compensation, draft prevention, pressure difference upkeep.

4. Determine prohibited frequency

- ◆ There is a certain prohibited frequency such as a power supply frequency.

Initial Frequency

When starting the compressor, the frequency is initialized according to the ΔD value of the indoor unit.

 ΔD signal: Indoor frequency command

The difference between the room thermistor temperature and the target temperature is taken as the ΔD value and is used for ΔD signal of frequency command.

In Cooling Mode

Temperature difference (°C)	ΔD signal
-1.5	0
-1.0	1
-0.5	2
0.0	3
0.5	4
1.0	5
1.5	6
2.0	7
2.5	8
3.0	

In Heating Mode

Temperature difference (°C)	ΔD signal
-1.5	0
-1.0	1
-0.5	2
0.0	3
0.5	4
1.0	5
1.5	6
2.0	7
2.5	8
3.0	9
3.5	
4.0	

In Dry Mode

Temperature difference (°C)	ΔD signal
-1.5	0
-1.0	1
-0.5	2
0.0	3
0.5	4
1.0	5
1.5	6
2.0	7
2.5	8

Temperature difference (°F)	ΔD signal
-2.7	0
-1.8	1
-0.9	2
0.0	3
0.9	4
1.8	5
2.7	6
3.6	7
4.5	8
5.4	

Temperature difference (°F)	ΔD signal
-2.7	0
-1.8	1
-0.9	2
0.0	3
0.9	4
1.8	5
2.7	6
3.6	7
4.5	8
5.4	9
6.3	
7.2	

Temperature difference (°F)	ΔD signal
-2.7	0
-1.8	1
-0.9	2
0.0	3
0.9	4
1.8	5
2.7	6
3.6	7
4.5	8

PI Control**1. P control**

ΔD value is calculated in each sampling time (20 seconds), and the frequency is adjusted according to its difference from the frequency previously calculated.

2. I control

If the operating frequency does not change for more than a certain fixed time, the frequency is adjusted according to ΔD value.

When ΔD is low, the frequency is lowered.

When ΔD is high, the frequency is increased.

3. Frequency control when other controls are functioning

- When frequency is dropping:
Frequency control is carried out only when the frequency drops.
- For controlling lower limit:
Frequency control is carried out only when the frequency rises.

4. Upper and lower limit of frequency by PI control

The frequency upper and lower limits are set according to the command of the indoor unit. When the indoor unit quiet operation command comes from the indoor unit, the upper limit frequency is lower than the usual setting.

3.3 Standby Electricity Saving (Suspend Function)

Outline

This function is to save standby electricity consumption while the air conditioner is not in operation by partially separating the electrical circuit of indoor and outdoor units from the power source.

Details

- When standby electricity saving is ON, the system enters suspend state if both indoor and outdoor units are not in operation.
- The system will not go into suspend state when some voltage is applied to the outdoor unit for protection purpose even if the indoor unit is not in operation.
- In suspend state, power supply to the outdoor unit is halted and there is no communication between the indoor unit and the outdoor unit.
Also the service monitor LED (LED A) lights off.
- To return from the suspend state, start fan or other operation to turn on the indoor unit.

3.4 Controls at Mode Changing/Start-up

3.4.1 3-Minute Standby

Turning on the compressor is prohibited for 3 minutes after turning off.

3.4.2 Compressor Protection Function

When turning the compressor from OFF to ON, the upper limit of frequency is set as follows.

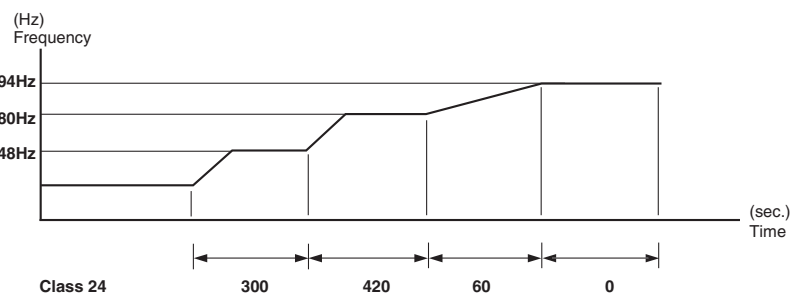
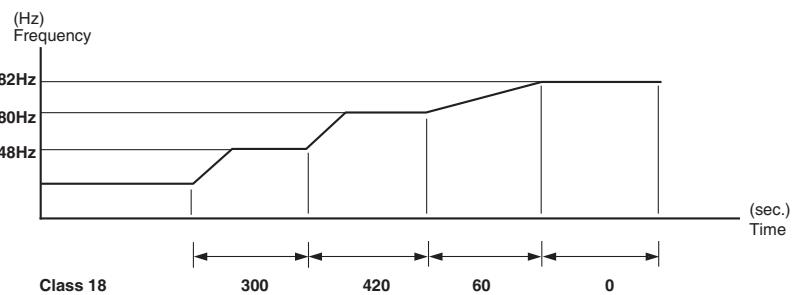
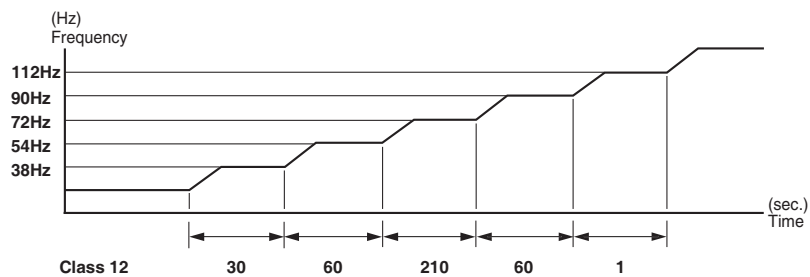
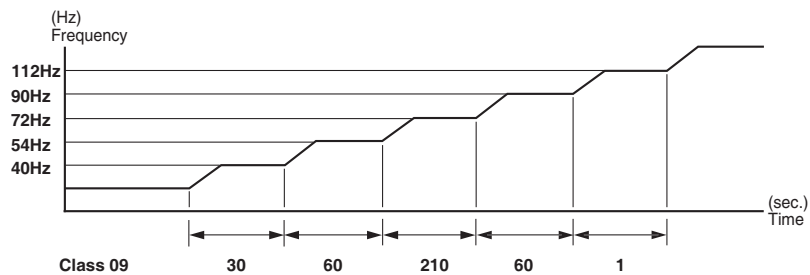

3.4.3 Four Way Valve Switching

Outline

Heat Pump Only

During the heating operation current must be conducted and during cooling and defrosting current must not be conducted. In order to eliminate the switching sound (as the four way valve coil switches from ON to OFF) when the heating is stopped, the delay switch of the four way valve must be carried out after the operation stopped.

Details

The OFF delay of four way valve
Energize the coil for x sec after unit operation is stopped.

Class	X
09/12/18/24	160 seconds

3.4.4 Four Way Valve Operation Compensation

Outline

Heat Pump Only

At the beginning of the operation as the four way valve is switched, acquire the differential pressure required for activating the four way valve by having output the operating frequency, which is more than a certain fixed frequency, for a certain fixed time.

Details

Starting Conditions

1. When starting compressor for heating.
2. When the operating mode changes to cooling from heating.
3. When starting compressor for rushing defrosting or resetting.
4. When starting compressor for the first time after the reset with the power is ON.
5. When starting compressor for heating next to the suspension of defrosting.
6. When starting compressor next to the fault of switching over cooling/heating.

3.5 Discharge Pipe Temperature Control

Outline

The discharge pipe temperature is used as the internal temperature of the compressor. If the discharge pipe temperature rises above a certain level, the upper limit of frequency is set to keep the discharge pipe temperature from rising further.

Details

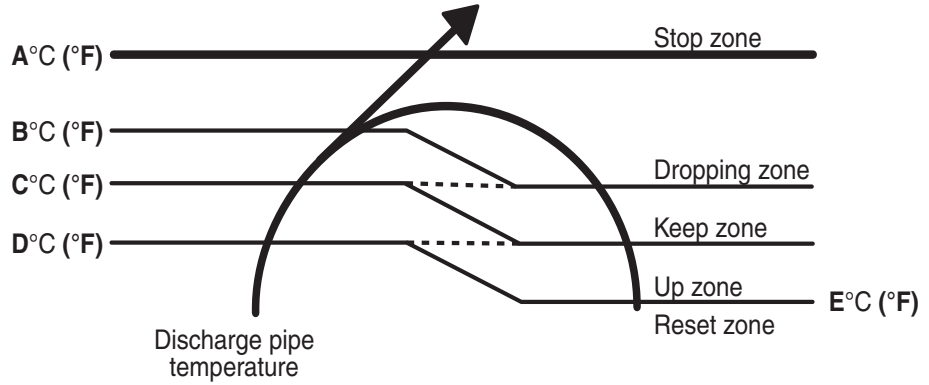

Zone	Control
Stop zone	When the temperature reaches the stop zone, the compressor stops.
Dropping zone	The upper limit of frequency decreases.
Keep zone	The upper limit of frequency is kept.
Up zone	The upper limit of frequency increases.
Reset zone	The upper limit of frequency is cancelled

	Class	
	09/12	18/24
A (°C)	110	118
B (°C)	105	104
C (°C)	98	99
D (°C)	93	93
E (°C)	88	81

	Class	
	09/12	18/24
A (°F)	230	244.4
B (°F)	221	219.2
C (°F)	208.4	210.2
D (°F)	199.4	199.4
E (°F)	190.4	177.8

3.6 Input Current Control

Outline

The microcomputer calculates the input current while the compressor is running, and sets the frequency upper limit based on the input current.

Details

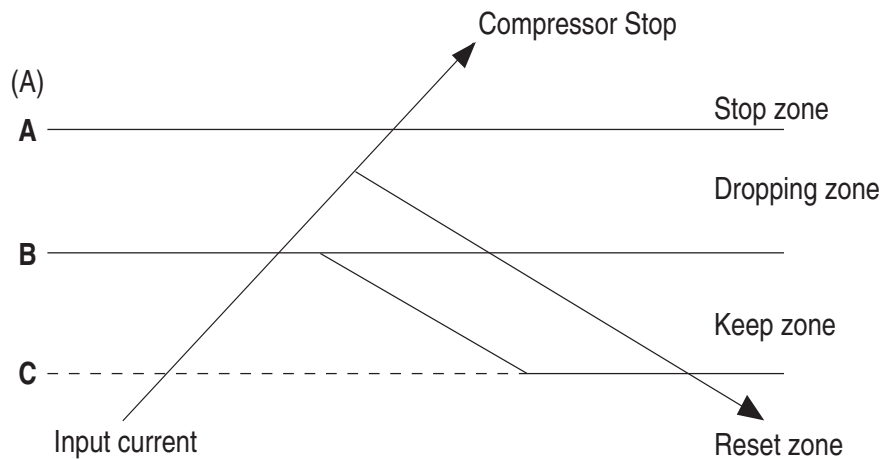

■ Frequency control in each zone

Zone	Control
Stop zone	After the input current remains in the stop zone for 2.5 seconds, the compressor is stopped.
Dropping	The upper limit of the compressor frequency is defined as operation frequency – 2 Hz. After this, the output frequency is lowered by 2 Hz every second until it reaches the keep zone.
Keep zone	The present maximum frequency goes on.
Reset zone	Limit of the frequency is cancelled.

Mode	Current (A)	Class			
		09	12	18	24
Cooling	A	14	14	13	13
	B	7	7	11	11
	C	6.25	6.25	10	10

Mode	Current (A)	Class			
		09	12	18	24
Heating	A	14	14	16	16
	B	7.75	7.75	13	13
	C	7	7	12	12

■ Limitation of current dropping and stop value according to the outdoor temperature

- ◆ The current drops when outdoor temperature becomes higher than a certain level (depending on the model).

3.7 Freeze-up Protection Control

Outline During cooling operation, the signals sent from the indoor unit control the operating frequency limitation and prevent freezing of the indoor heat exchanger. The signal from the indoor unit is divided into zones.

Details The operating frequency limitation is judged with the indoor heat exchanger temperature.

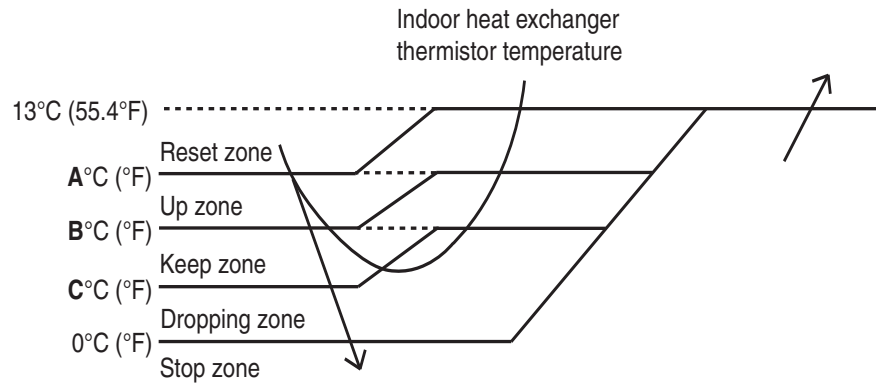

■ Frequency control in each zone

Zone	Control
Reset zone	The upper limit of frequency is cancelled
Up zone	The upper limit of frequency increases
Keep zone	The upper limit of frequency is kept
Dropping zone	The upper limit of frequency decreases
Stop zone	When indoor coil temperature <0°C for >80s, compressor is stopped

All classes

A (°C)	7.0
B (°C)	5.0
C (°C)	3.0

All classes

A (°F)	44.6
B (°F)	41.0
C (°F)	37.4

3.8 Heating Peak-cut Control

Outline

Heat Pump Only

During heating operation, the signals being sent from the indoor unit allow the operating frequency limitation and prevent abnormal high pressure. (The signal from the indoor unit must be divided as follows.)

Details

Conditions for Start Controlling

Judge the controlling start with the indoor heat exchanger temperature after 2 sec. from operation start.

Control in Each Zone

The heat exchange intermediate temperature of indoor unit controls the following.

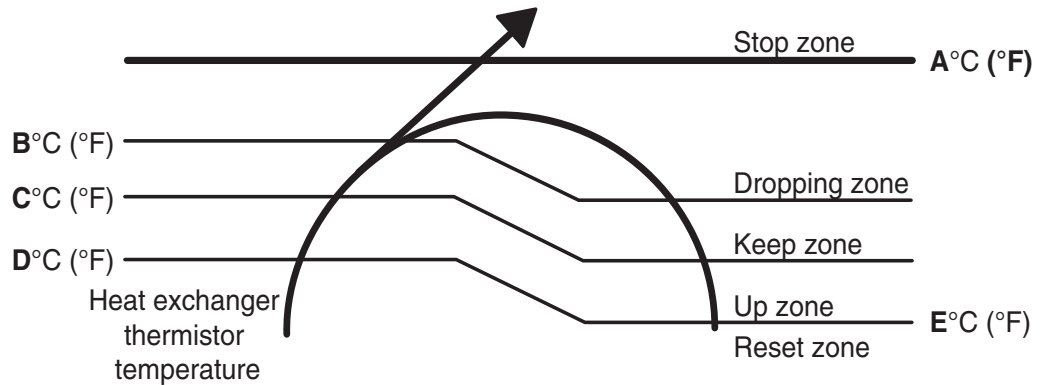

■ Frequency control in each zone

Zone	Control
Stop zone	When indoor coil temperature stop zone, the compressor stops
Dropping zone	The upper limit of frequency decreases
Keep zone	The upper limit of frequency is kept
Up zone	The upper limit of frequency increases
Reset zone	The upper limit of frequency is cancelled

	Class			
	09	12	18	24
A (°C)	59.0		64.0	
B (°C)	55.0		54.0	
C (°C)	52.0		53.0	
D (°C)	50.0		51.0	
E (°C)	45.0		49.0	

	Class			
	09	12	18	24
A (°F)	138.2		147.2	
B (°F)	131.0		129.2	
C (°F)	125.6		127.4	
D (°F)	122.0		123.8	
E (°F)	113.0		120.2	

3.9 Outdoor Fan Control

1. Fan ON control to cool down the electrical box

The outdoor fan is turned ON when the electrical box temperature is high while the compressor is OFF.

2. Fan OFF delay when stopped

The outdoor fan is turned OFF x seconds after the compressor stops.

Model	X
Class 09/12	70 seconds
Class 18/24	90 seconds

3. Fan speed control for pressure difference upkeep

The rotation speed of the outdoor fan is controlled for keeping the pressure difference during cooling operation with low outdoor temperature.

- When the pressure difference is low, the rotation speed of the outdoor fan is reduced.
- When the pressure difference is high, the rotation speed of the outdoor fan is controlled as well as normal operation.

4. Fan speed control during forced cooling operation

The outdoor fan is controlled as well as normal operation during forced cooling operation.

5. Fan speed control during POWERFUL operation

The rotation speed of the outdoor fan is increased during POWERFUL operation.

6. Fan speed control during indoor unit quiet operation

The rotation speed of the outdoor fan is reduced by the command of the indoor unit quiet operation.

7. Fan ON/OFF control when operation (cooling, dry) starts/stops

The outdoor fan is turned ON when the operation starts. The outdoor fan is turned OFF when the operation stops.

8. Fan control when defrosting

9. Fan control when the compressor starts for heating

3.10 Liquid Compression Protection Function

Outline In order to increase the dependability of the compressor, the compressor is stopped according to the outdoor temperature.

Details Operation stops depending on the outdoor temperature. The compressor turns off under the conditions that the system is in cooling operation and outdoor temperature is below X°C (X°F).

X refer to table below based on models

	Class 09/12/18/24
X (°C)	-12

	Class 09/12/18/24
X (°F)	10.4

3.11 Defrost Control

Outline **Heat Pump Only**
Defrosting is carried out by the cooling cycle (reverse cycle). The defrosting time or outdoor heat exchanger temperature must be more than its fixed value when finishing.

Details **Conditions for Starting Defrost**
The starting conditions must be made with the outdoor air temperature and heat exchanger temperature. Under the conditions that the system is in heating operation, 6 minutes after the compressor is started and more than 28 minutes of accumulated time pass since the start of the operation or ending the defrosting.

Conditions for Canceling Defrost
The judgment must be made with heat exchanger temperature. (4°C-22°C) or (39.2°F to 71.6°F)

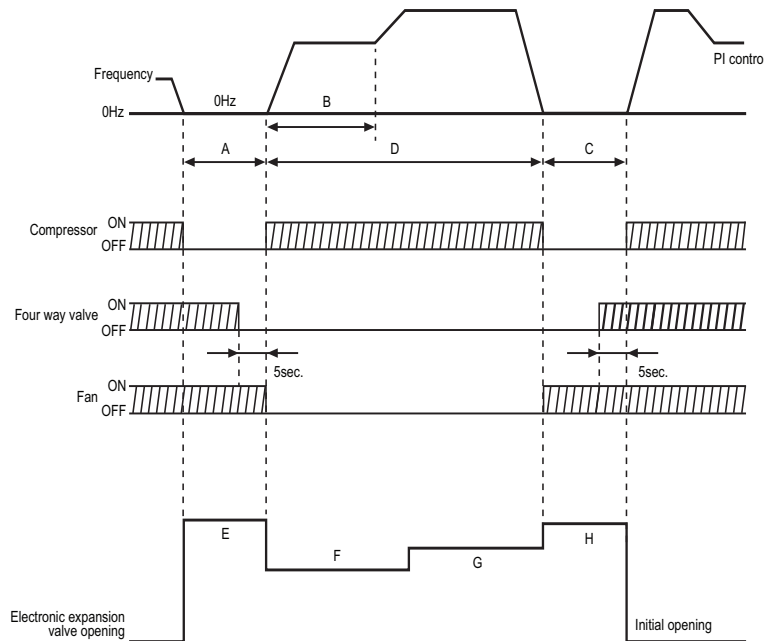

Class	Time (sec)				Pulse			
	A	B	C	D	E	F	G	H
09	40	120	40	630	400	300	300	350
12	40	120	40	630	400	300	300	350
18	60	120	60	570	450	400	400	400
24	60	120	60	570	450	400	400	400

3.12 Electronic Expansion Valve Control

3.12.1 Summary of Electronic Expansion Valve Control

Controlling the electronic expansion valve is to ensure the reliability while optimizing the refrigerating cycle responding to the operation status. The summary of electronic expansion valve control is shown as below.

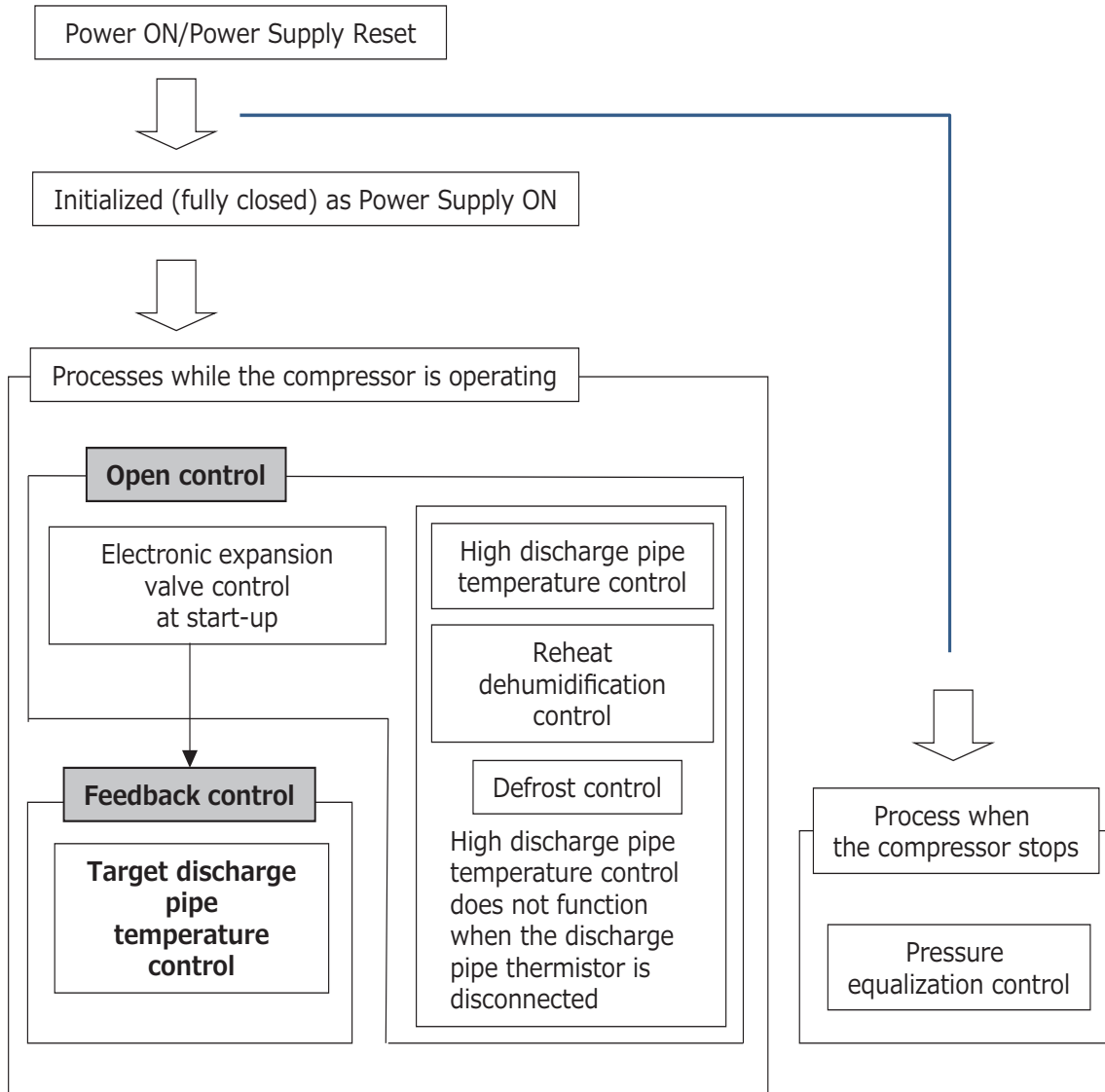

3.12.2 Full Close as Power Supply ON

When the power is turned ON, the electronic expansion valve is initialized to position the valve opening and facilitate pressure equalization. (Prevent the compressor from being locked by start-up with differential pressure)

Processes as power supply ON

- Turn the power ON, close P_{ON} pulses and set the current opening at 0 pulse.
- Open P_x pulses after the full close process completed.

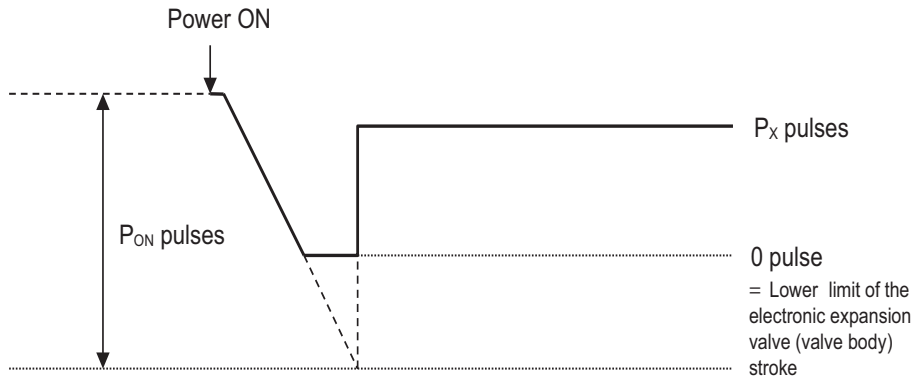

Process after resuming from stand-by electricity saving (suspend) mode

Set the electronic expansion valve opening at P_x pulses after resuming from stand-by electricity saving mode.

Class	09	12	18	24
P_{ON}	700	700	720	720
P_x	400	400	450	450

3.12.3 Pressure Equalization Control

When the compressor is switched from ON to OFF, open the electronic expansion valve to facilitate pressure equalization while preventing the sound produced from refrigerant flow at pressure equalization.

Summary of operation

Open the electronic expansion valve in a phased manner for 90-120 seconds when operation stop (including abnormal stoppage) or the thermostat is turned OFF.

→ Fully closed → open P_x pulses

3.12.4 Initialization as Power Supply On

The electronic expansion valve is initialized (fully closed) when the power is turned on. Then, the valve opening position is set and the pressure is equalized.

3.12.5 Pressure Equalizing Control

When the compressor is stopped, the pressure equalizing control is activated. The electronic expansion valve opens and the pressure is equalized.

3.12.6 Opening Limit Control

The maximum and minimum opening of the electronic expansion valve are limited.

Electronic Expansion valve opening (pulse)	09	12	18	24
Maximum	470	470	480	480
Minimum	52	52	52	52

3.12.7 Starting Operation Control

The electronic expansion valve opening is controlled when the operation starts, thus preventing superheating or liquid compression.

3.12.8 Control when the Frequency Changes

When the target discharge pipe temperature control is active, if the target frequency changes to a specified value in a certain period of time, the target discharge pipe temperature control is canceled and the target opening of the electronic expansion valve is changed according to the frequency shift.

3.12.9 High Discharge Pipe Temperature Control

When the compressor is operating, if the discharge pipe temperature exceeds a certain value, the electronic expansion valve opens and the refrigerant runs to the low pressure side. This procedure lowers the discharge pipe temperature by cooling the compressor with refrigerant.

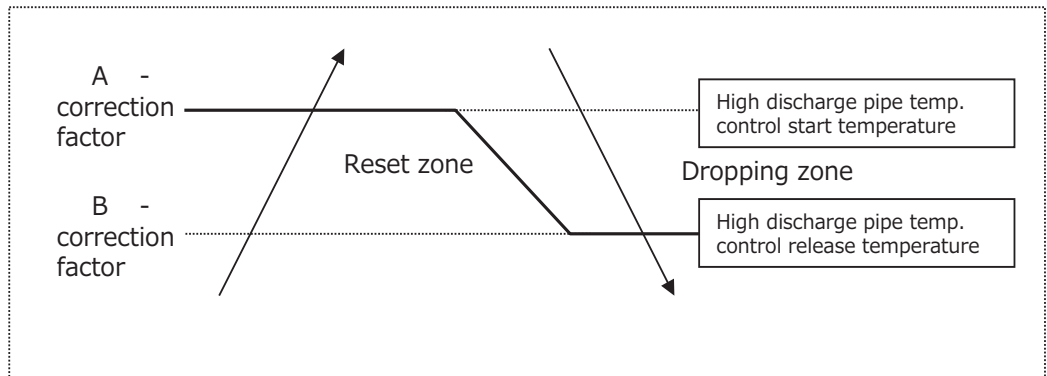

		Class			
		09	12	18	24
A (°C)		102	102	101	101
B (°C)		100	100	96	96

		Class			
		09	12	18	24
A (°F)		215.6	215.6	213.8	213.8
B (°F)		213.8	213.8	204.8	204.8

3.12.9-1 Determine Zones

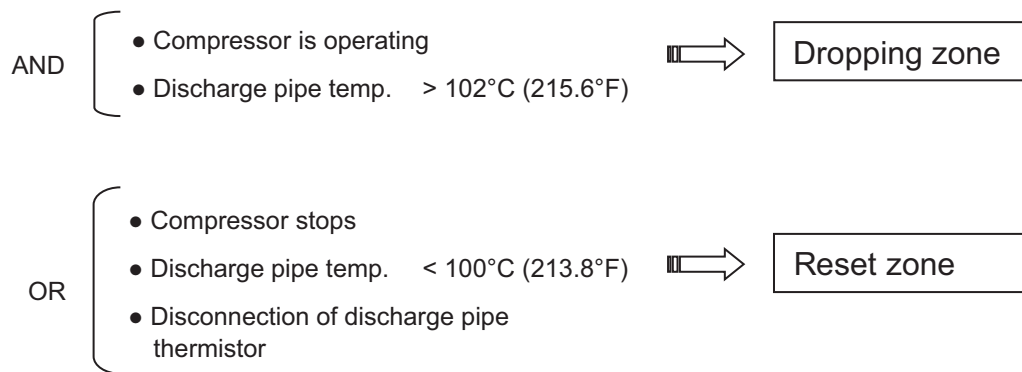

3.12.9-2 Process for Each Zone

Dropping zone: Open the current opening by +X pulses every Y seconds
 Reset zone: Release control and shift to target discharge pipe temperature control

Applicable Model: RK(X)09/12/18/24AXVJU			
X	20	Y	30

3.12.10 Discharge Pipe Thermistor Disconnection Control

Outline

The disconnection of the discharge pipe thermistor is detected by comparing the discharge pipe temperature with the condensing temperature. If the discharge pipe thermistor is disconnected, the electronic expansion valve opens according to the outdoor temperature and the operation frequency, operates for a specified time, and then stops. After 3 minutes, the operation restarts and checks if the discharge pipe thermistor is disconnected. If the discharge pipe thermistor is disconnected, the system stops after operating for a specified time. If the disconnection is detected repeatedly, the system is shut down. When the compressor runs for 60 minutes without any error, the error counter is reset.

Details

Determining thermistor disconnection

When the starting control (**A** seconds) finishes, the detection timer for disconnection of the discharge pipe thermistor (**B** seconds) starts. When the timer is over, the following adjustment is made. When the following condition is fulfilled, the discharge pipe thermistor disconnection is ascertained.

For cooling mode:

$$\text{Discharge pipe temperature} + C^{\circ}\text{C} (^{\circ}\text{F}) < \text{outdoor heat exchanger temperature}$$

Class	09/12	18/24
A	10	10
B	720	540
C (°C)	6	6
C (°F)	42.8	42.8

For heating mode:

$$\text{Discharge pipe temperature} + D^{\circ}\text{C} (^{\circ}\text{F}) < \text{indoor heat exchanger temperature}$$

Class	09/12	18/24
A	120	30
B	720	540
D (°C)	6	6
D (°F)	42.8	42.8

When the thermistor is disconnected

When the disconnection is ascertained, the compressor continues operation for 9 minutes and then stops. If the compressor stops repeatedly, the system is shut down.

3.12.11 Target Discharge Pipe Temperature Control

The target discharge pipe temperature is obtained from the indoor and outdoor heat exchanger temperature, and the electronic expansion valve opening is adjusted so that the actual discharge pipe temperature becomes close to the target discharge pipe temperature. (Indirect SH (superheating) control using the discharge pipe temperature)

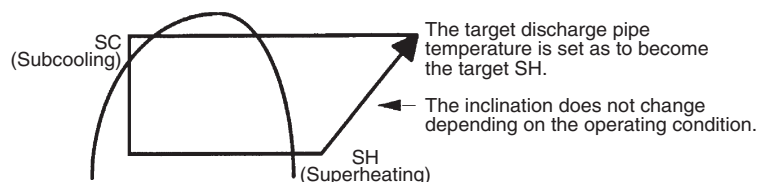

The electronic expansion valve opening and the target discharge pipe temperature are adjusted every **A** seconds. The opening degree of the electronic expansion valve is adjusted by the following.

- Target discharge pipe temperature
- Actual discharge pipe temperature
- Previous discharge pipe temperature

A (seconds)	20
--------------------	----

3.13 Malfunctions

3.13.1 Sensor Malfunction Detection

Sensor malfunction can be detected in the following thermistors in open or short circuit.

1. Outdoor heat exchanger thermistor
2. Discharge pipe thermistor
3. Radiation fin thermistor
4. Outdoor temperature thermistor

3.13.2 Detection of Overcurrent and Overload

Outline

In order to protect the inverter, an excessive output current is detected in wire labelled as No 1 at outdoor terminal block and the OL temperature is observed to protect the compressor.

Details

- If the inverter current exceeds **A** (A), the system shuts down the compressor.
- If the OL (compressor body) temperature exceeds **B**°C (°F), the compressor stops.

During Cooling

Class	09/12	18/24
A (A)	14.0	13.0
B (°C)	125.0	125.0
B (°F)	257.0	257.0

During Heating

Class	09/12	18/24
A (A)	14.0	16.0
B (°C)	125.0	125.0
B (°F)	257.0	257.0

Part 4 Remote Controller

1. Applicable Remote Controller	49
2. BRC52B63	50

1. Applicable Remote Controller

Series	Model Name	Remote Controller
FTXC	FTXF09/12/18/24AXVJU	BRC52B63

2. BRC52B63

FTXB09/12/18/24BXVJU

REMOTE CONTROLLER OVERVIEW

For cooling/heating model

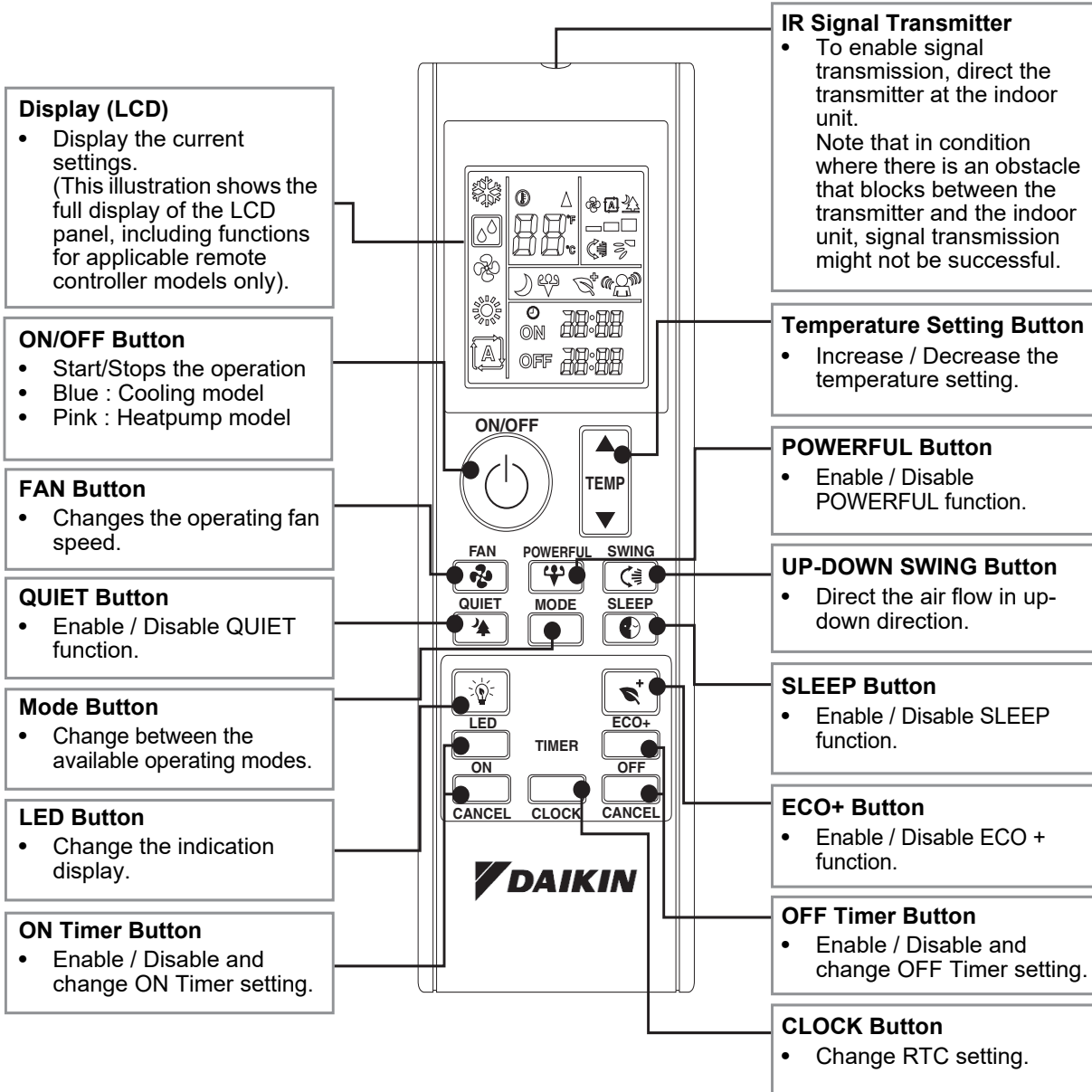

Part 5

Service Diagnosis

1. General Problem Symptoms and Check Items	52
2. Troubleshooting with LED	53
2.1 Indoor Unit.....	53
2.2 Outdoor Unit.....	53
3. Error Diagnosis	54
3.1 To enter error diagnosis	54
4. Troubleshooting	55
4.1 Error Codes and Description	55
4.2 Indoor Unit PCB Abnormality	57
4.3 Freeze-up Protection Control	58
4.4 Indoor Fan Motor (DC Motor) or Related Abnormality	59
4.5 Thermistor or Related Abnormality (Indoor Unit).....	60
4.6 Thermistor or Related Abnormality (Indoor Unit).....	61
4.7 Low-voltage Detection or Over-voltage Detection	63
4.8 Signal Transmission Error (Between Indoor Unit and Outdoor Unit).....	65
4.9 Installation error.....	68
4.10 Outdoor Unit PCB Abnormality.....	71
4.11 Actuation of High Pressure Switch	72
4.12 OL Activation (Compressor Overload)	73
4.13 OL Activation (Compressor Overload) or HPS Activation (High Pressure Switch).....	75
4.14 Compressor Lock	77
4.15 DC Fan Lock	78
4.16 Input Overcurrent Detection	79
4.17 Discharge Pipe Temperature Control.....	80
4.18 High Pressure Control in Cooling	81
4.19 Compressor System Sensor Abnormality	83
4.20 Position Sensor Abnormality	84
4.21 Thermistor or Related Abnormality (Outdoor Unit).....	85
4.22 Electrical Box Temperature Rise	87
4.23 Radiation Fin Temperature Rise	88
4.24 Output Overcurrent Detection	90
4.25 Four Way Valve Abnormality.....	92
5. Actuator Check.....	94
5.1 Thermistor Resistance Check	94
5.2 Power Supply Waveform Check.....	95
5.3 Electronic Expansion Valve Check.....	95
5.4 Four Way Valve Performance Check	96
5.5 Inverter Unit Refrigerant System Check.....	97
5.6 Rotation Pulse Check on the Outdoor Unit PCB	97
5.7 Installation Condition Check.....	99
5.8 Discharge Pressure Check.....	99
5.9 Outdoor Fan System Check	100
5.10 Main Circuit Short Check.....	100
5.11 Power Module Check	102

1. General Problem Symptoms and Check Items

Symptom	Check Item	Details	Reference Page
The unit does not operate.	Check the power supply.	Check if the rated voltage is supplied.	—
	Check the type of the indoor unit.	Check if the indoor unit type is compatible with the outdoor unit.	—
	Check the outdoor temperature.	Cooling operation is not available when the outdoor temperature is out of the operation limit. Check the reference page for the operation limit.	117
	Diagnose with remote controller indication	—	50
	Check the remote controller addresses.	Check if address settings for the remote controller and indoor unit are correct.	—
Operation sometimes stops.	Check the power supply.	A power failure of 2 to 10 cycles can stop air conditioner operation. (Operation lamp OFF)	—
	Check the outdoor temperature.	Cooling operation is not available when the outdoor temperature is out of the operation limit. Check the reference page for the operation limit.	117
	Diagnose with remote controller indication.	—	50
The unit operates but does not cool.	Check for wiring and piping errors in the connection between the indoor and outdoor units.	—	—
	Check for thermistor detection errors.	Check if the thermistor is mounted securely.	—
	Check for faulty operation of the electronic expansion valve.	Set the unit to cooling operation, and check the temperatures of the liquid pipe to see if the electronic expansion valve works.	—
	Diagnose with remote controller indication.	—	50
	Diagnose by service port pressure and operating current.	Check for refrigerant shortage.	—
Large operating noise and vibrations	Check the output voltage of the power module.	—	102
	Check the power module.	—	—
	Check the installation condition.	Check if the required spaces for installation (specified in the installation manual) are provided.	—

2. Troubleshooting with LED

2.1 Indoor Unit

Operation Lamp

The operation lamp blinks when any of the following errors is detected.

1. A protection device of the indoor or outdoor unit is activated, or the thermistor malfunctions.
2. A signal transmission error occurs between the indoor and outdoor units.

In either case, conduct the diagnostic procedure described in the following pages.

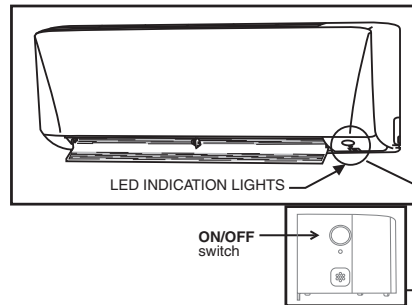

2.2 Outdoor Unit

The outdoor unit has a green LED (LED A) on the PCB.

When the microcomputer works in order, the LED A blinks.

Refer to pages 115, 116 for the location of LED A

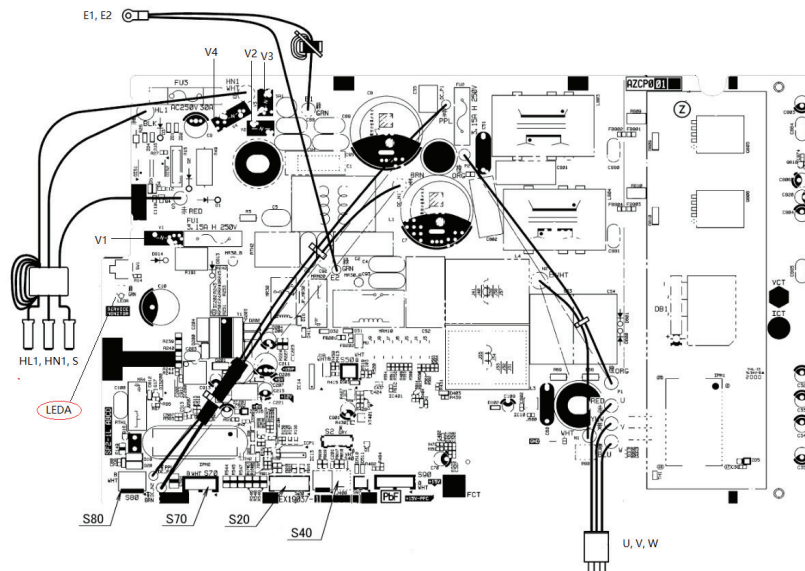
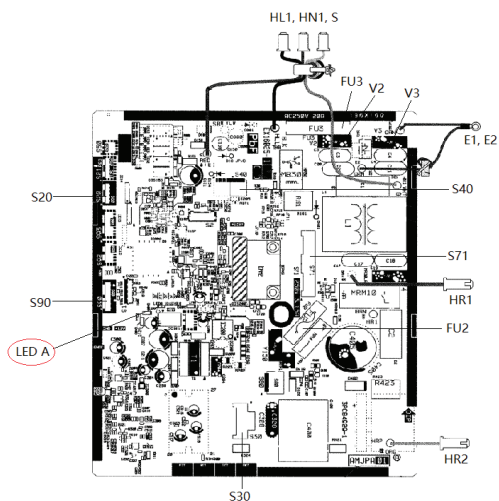

3. Error Diagnosis

3.1 To enter error diagnosis

GV : Press [Timer CANCEL] to scroll to next

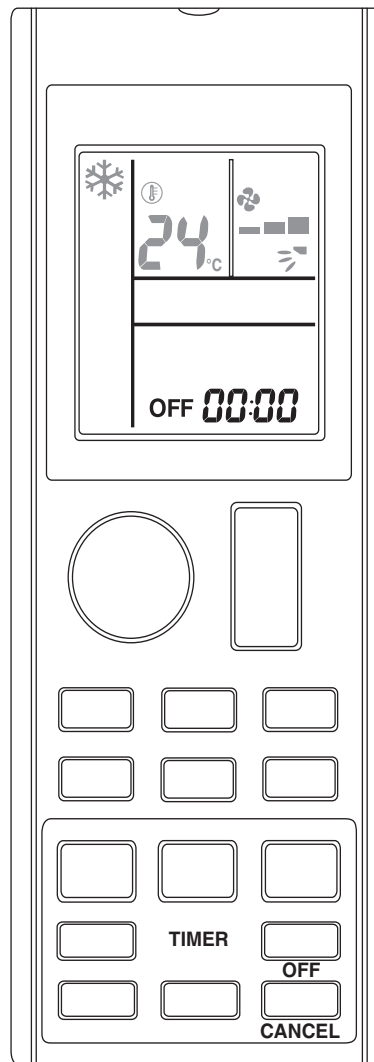

GV

i Notes

1. A short beep and two consecutive beeps indicate non-corresponding codes.
2. To return to the normal mode.

GV : Press [Timer CANCEL] for 5 seconds

When the remote controller is left untouched for 60 seconds, it also returns to the normal mode.

4. Troubleshooting

4.1 Error Codes and Description

	Error Codes	Description	Reference Page
System	00	Normal condition	-
	U2	Low-voltage detection or over-voltage detection	63
	U4	Signal transmission error (between indoor unit and outdoor unit)	65
	UA	Installation error (between indoor unit and outdoor unit)	68
Indoor Unit	A1	Indoor unit PCB abnormality	57
	A5	Freeze-up protection control	58
	A6	Indoor fan motor (DC motor) or related abnormality	59
	C4	Indoor heat exchanger thermistor or related abnormality	60
	C9	Room temperature thermistor or related abnormality	61
Outdoor Unit	E1	Outdoor unit PCB abnormality	71
	E3	Actuation of high pressure switch	72
	E5 ★	OL activation (compressor overload)	73
		OL activation (compressor overload) or HPS activation (high pressure switch)	75
	E6 ★	Compressor lock	77
	E7 ★	DC fan lock	78
	E8	Input overcurrent detection	79
	F3	Discharge pipe temperature control	80
	F6	High pressure control in cooling	81
	EA	Four way valve abnormality	92
	H0	Compressor sensor system abnormality	83
	H6	Position sensor abnormality	84
	H9	Outdoor temperature thermistor or related abnormality	85
	J3 ★	Discharge pipe thermistor or related abnormality	85
	J6	Outdoor heat exchanger thermistor or related abnormality	85
	L3	Electrical box temperature rise	87
	L4	Radiation fin temperature rise	88
	L5	Output overcurrent detection	90
P4	Radiation fin thermistor or related abnormality	85	

★Displayed only when the system is shut down.

■ Error Code Definition

Error Code	Checklist	Meaning
00	○	Normal
A1	○	Indoor PCB error
A3		Drain pump abnormal
A5	○	Antifreeze
A6	○	Indoor fan motor abnormal
AH		Electrical air cleaner abnormal
C4	○	Indoor heat exchanger (1) thermistor short / open
C5		Indoor heat exchanger (2) thermistor short / open
C7		Louver limit switch error
C9	○	Indoor room thermistor short / open
E1	○	Outdoor PCB error
E3	○	High pressure protection
E4		Low pressure protection
E5	○	Compressor motor lock / compressor overload
E6	○	Compressor start-up error
E7	○	Outdoor DC fan motor lock
E8	○	AC input overcurrent
E9		EXV error
EA	○	4 way valve error
F3	○	Discharge pipe overheat
F6	○	Heat exchanger overheat
H0	○	Compressor sensor system error
H3	○	High pressure switch error
H6	○	Compressor feedback detection error
H7		Fan motor overload / overcurrent / sensor abnormal
H8		AC current sensor error
H9	○	Outdoor air thermistor short / open
J1		Pressure sensor error
J3	○	Compressor discharge pipe thermistor short / open / misplaced
J5		Suction pipe thermistor short / open
J6	○	Outdoor heat exchanger thermistor short / open
J7		Subcooling heat exchanger thermistor short / open
J8		Liquid pipe thermistor short / open
J9		Gas pipe thermistor short / open
L1		Inverter outdoor PCB error
L3	○	Outdoor control box overheat
L4	○	Heat sink overheat
L5	○	IPM error / IGBT error
L8		Inverter compressor overcurrent
L9		Compressor overcurrent prevention
LC		Communication error (outdoor control PCB and inverter PCB)
P1		Open phase or voltage unbalance
P4	○	Heat sink thermistor short / open
PJ		Capacity setting error
U0		Insufficient gas
U2	○	DC voltage out of range
U4	○	Communication error
U7		Communication error (outdoor control PCB and IPM PCB)
UA	○	Installation error (wrong combination of ID and OD units / wrong or defective ID/OD PCB installed)
UF		Piping & wiring installation mismatch / wrong wiring / insufficient gas

4.2 Indoor Unit PCB Abnormality

Error Code	A1
Description	Indoor unit ON/OFF switch abnormality or indoor control PCB EEPROM error.
Method of Error Detection	The system checks if the ON/OFF switch works properly.
Error Decision Conditions	ON/OFF switch malfunction.
Possible root cause	1. Defective indoor unit ON/OFF switch. 2. Defective indoor unit control PCB (EEPROM).

Troubleshooting

 **Caution** Be sure to turn off the power switch before connecting or disconnecting connectors, or parts may be damaged.

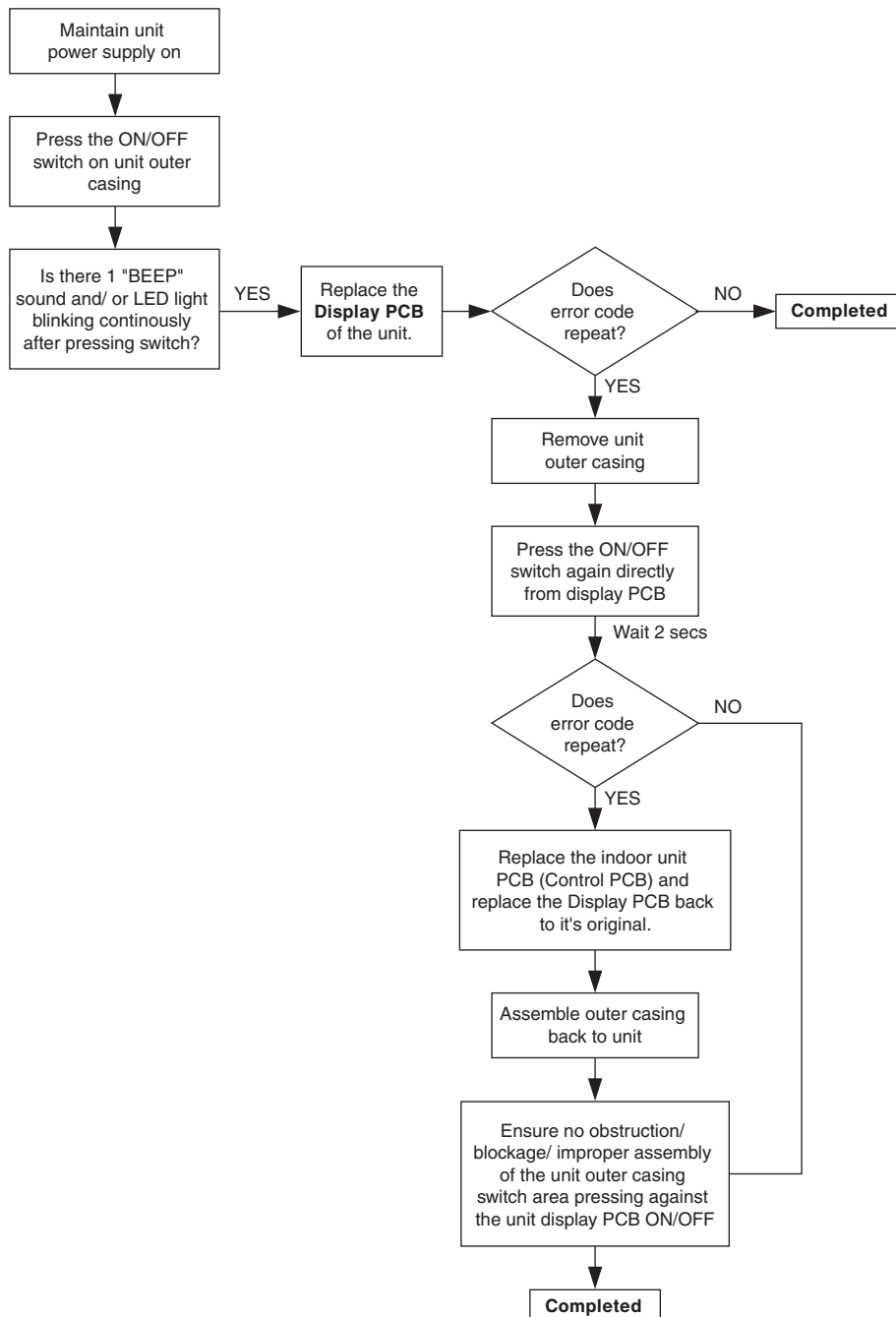

4.3 Freeze-up Protection Control

Error Code	A5
Method of Error Detection	<p>During cooling operation, the freeze-up protection control (operation halt) is activated according to the temperature detected by the indoor heat exchanger thermistor.</p> <p>High pressure control (heat pump model only).</p> <p>During heating operations, the temperature detected by the indoor heat exchanger thermistor is used for the high pressure control (stop, outdoor fan stop, etc.).</p>
Error Decision Conditions	<p>During cooling operation, the indoor heat exchange temperature is below 0°C (32°F).</p> <p>High pressure control</p> <p>During heating operations, the temperature detected by the indoor heat exchanger thermistor is above 61°C (141.8°F).</p>
Supposed Causes	<ul style="list-style-type: none"> ■ Indoor Short-circuited air ■ Clogged air filter of the indoor unit ■ Dust accumulation on the indoor heat exchanger ■ Defective indoor heat exchanger thermistor ■ Defective indoor unit PCB

Troubleshooting

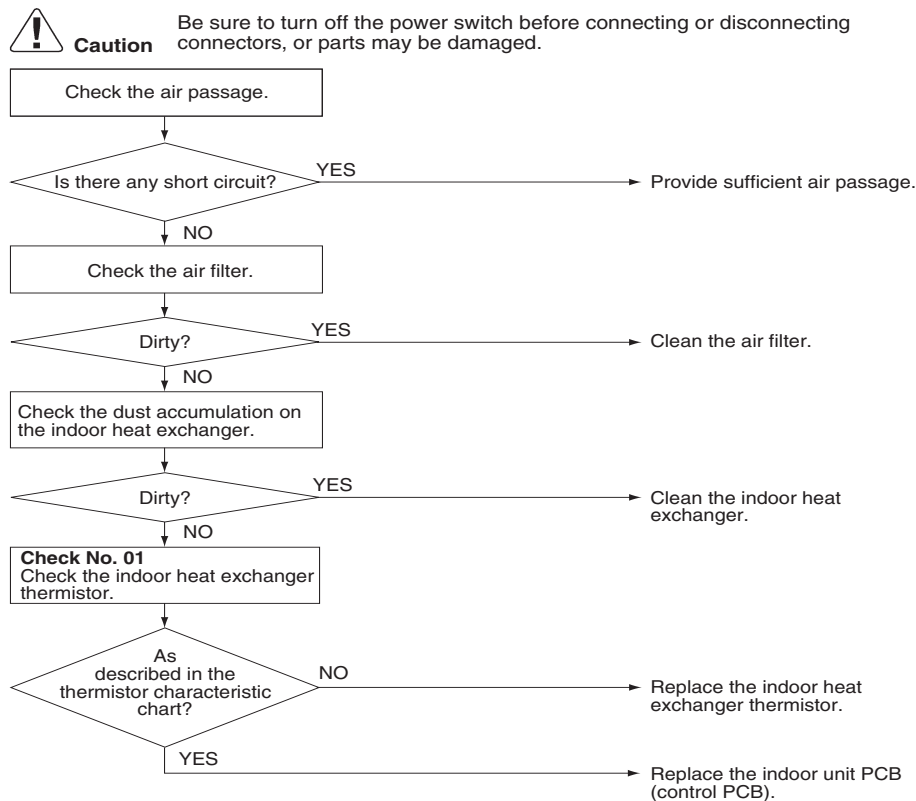

 **Reference**

Check No.01 Refer to P.94

 **Note**

When replacing the defective thermistor(s), replace the thermistor as ASSY.

4.4 Indoor Fan Motor (DC Motor) or Related Abnormality

Error Code	A6
Description	Abnormality of indoor fan motor or indoor unit PCB.
Objectives	<ol style="list-style-type: none"> 1. To check on the connection and functionality of indoor fan motor. 2. To check on the connection and functionality of indoor unit PCB.
Method of Error Detection	The rotation speed detected by the Hall IC during fan motor operation is used to determine abnormal fan motor operation.
Error Decision Conditions	The detected rotation speed does not reach the demanded rotation speed of the target tap, and is less than 50% of the maximum fan motor rotation speed.
Possible Root Causes	<ol style="list-style-type: none"> 1. Indoor fan motor winding short, or the motor lead wire broken. 2. Indoor PCB faulty.

Troubleshooting

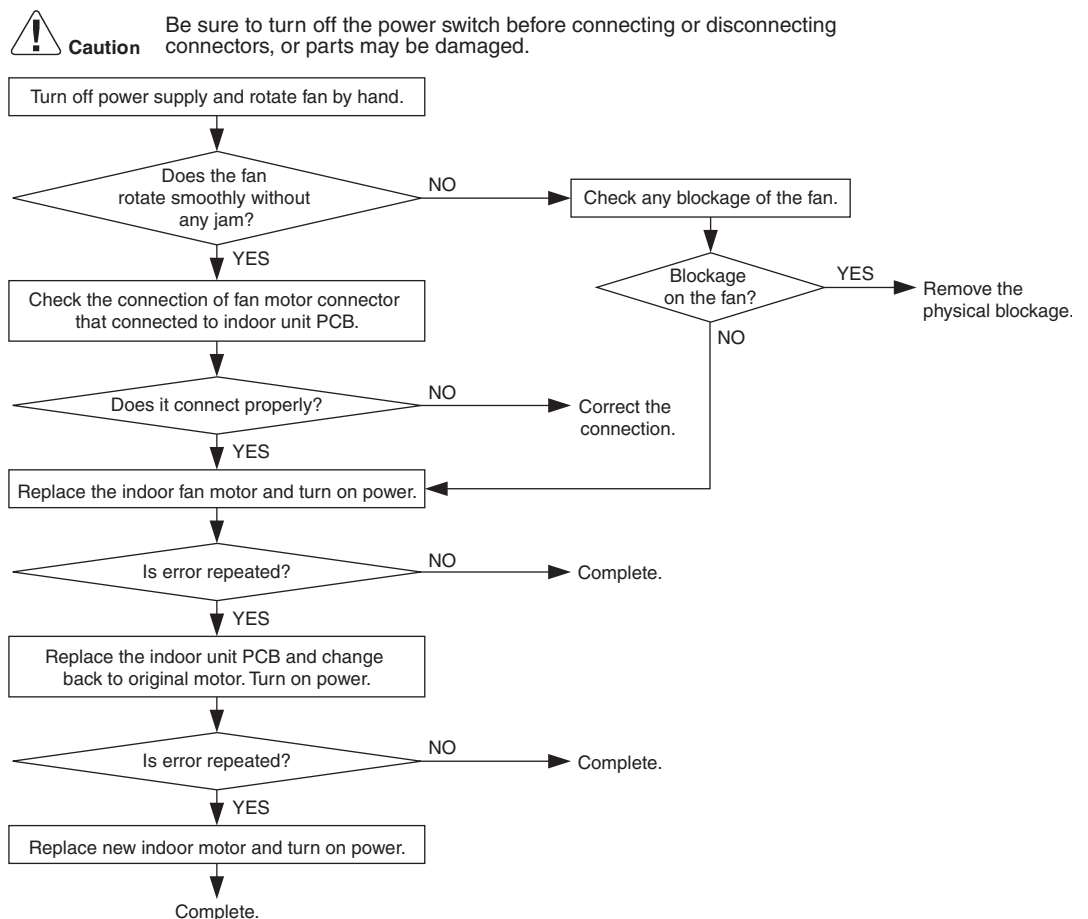

4.5 Thermistor or Related Abnormality (Indoor Unit)

Error Code	C4
Description	Abnormality of indoor coil thermistor or indoor unit PCB.
Objectives	<ol style="list-style-type: none"> 1. To check on the connection and functionality of indoor coil thermistor. 2. To check on the connection and functionality of indoor unit PCB.
Method of Error Detection	The temperature detected by the thermistors determine thermistor errors.
Error Decision Conditions	The resistance of the thermistor is out of range (0Ω or $\infty \Omega$)
Supposed Causes	<ul style="list-style-type: none"> ■ Disconnection of connector ■ Defective thermistor(s) ■ Defective indoor unit PCB

Troubleshooting

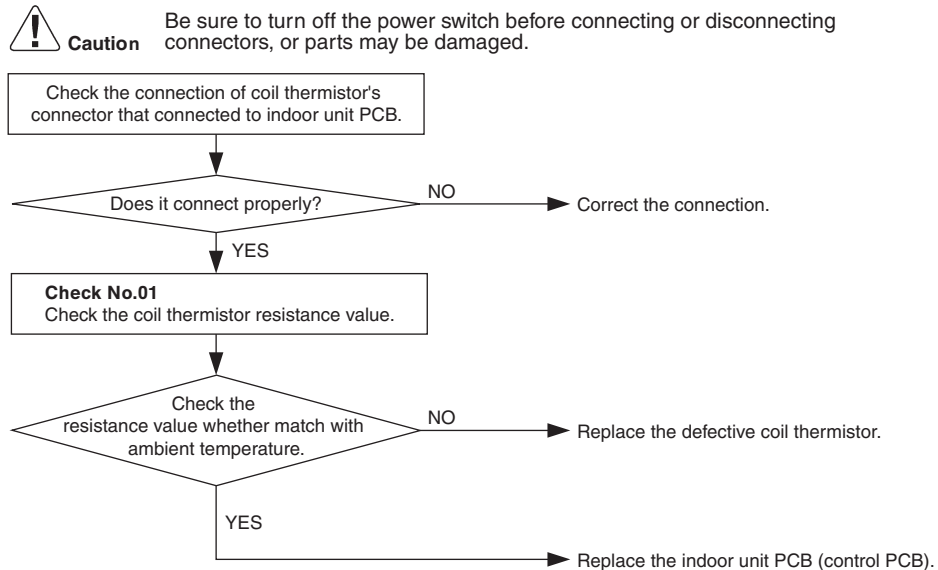

C4 : Indoor heat exchanger thermistor



Reference

Check No.01 Refer to P.94



Note

When replacing the defective thermistor(s), replace the thermistor as ASSY.

4.6 Thermistor or Related Abnormality (Indoor Unit)

Error Code	C9
Description	Abnormality of indoor room temperature thermistor or indoor unit PCB.
Objectives	<ol style="list-style-type: none"> 1. To check on the connection and functionality of indoor room temperature thermistor. 2. To check on the connection and functionality of indoor unit PCB.
Method of Error Detection	The temperature detected by the thermistors determine thermistor errors.
Error Decision Conditions	The resistance of the thermistor is out of range (0Ω or $\infty \Omega$)
Supposed Causes	<ul style="list-style-type: none"> ■ Disconnection of connector ■ Defective thermistor(s) ■ Defective indoor unit PCB

Troubleshooting

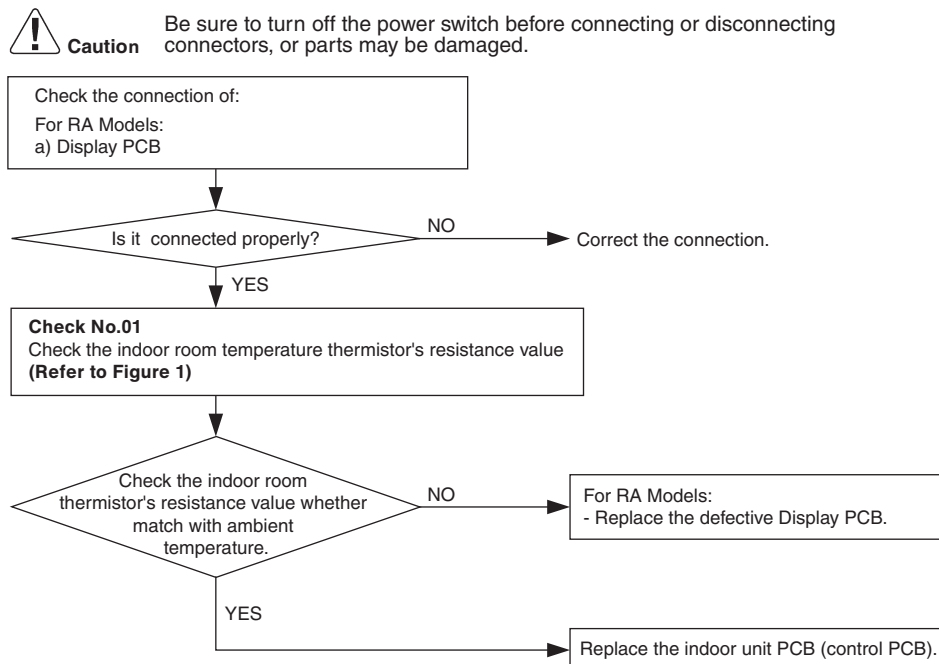

C9 : Room temperature thermistor



Reference

Check No.01 Refer to P.62

Check No.01

Measure the resistance of each thermistor using multimeter.

The resistance values are defined by below table.

If the measured resistance value does not match the listed value, the Display PCB or thermistor must be replaced.

- Disconnect the connector of thermistor ASSY from the PCB to measure the resistance between the pins using multimeter.
- To check the soldered thermistor on the Display PCB (applicable for all RA Indoor Inverter Models) disconnect the PCB from other PCB/parts, and measure the resistance as shown in Figure 1.

Figure 1

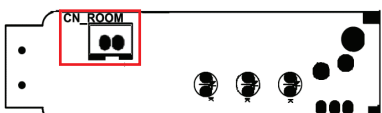
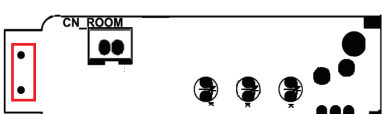
Illustration	Description	Models Involved
For all RA Indoor Inverter Models		
	Remove the Display PCB from its holder, turn it to the back and measure the point, CN_ROOM (boxed in red).	FTKU/FTKH
	Remove the Display PCB from its holder, turn it to the back and measure the point, CN_ROOM (boxed in red).	FTKF series
	Remove the Display PCB from its holder, turn it to the back and measure the point, CN_ROOM (boxed in red).	Entry Step 3

- To check the thermistor ASSY, measure the resistance between the both ends of the thermistor as shown below.

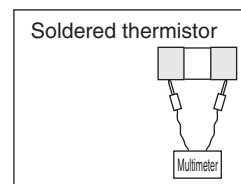
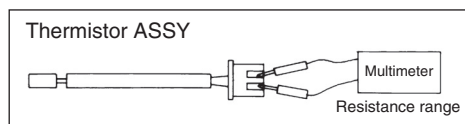

Thermistor's Resistance Value

T (°C)	T (°F)	R _{range} (Ω)
20.0	68.0	12.01 - 12.31
21.0	69.8	11.55 - 11.82
22.0	71.6	11.11 - 11.36
23.0	73.4	10.69 - 10.92
24.0	75.2	10.29 - 10.50
25.0	77.0	9.90 - 10.10
26.0	78.8	9.52 - 9.72
27.0	80.6	9.16 - 9.36

T (°C)	T (°F)	R _{range} (Ω)
28.0	82.4	8.82 - 9.02
29.0	84.2	8.49 - 8.69
30.0	86.0	8.17 - 8.37
31.0	87.8	7.87 - 8.07
32.0	89.6	7.58 - 7.78
33.0	91.4	7.31 - 7.50
34.0	93.2	7.04 - 7.23
35.0	95.0	6.79 - 6.98

Note

When replacing the defective thermistor(s), replace the thermistor as ASSY.

4.7 Low-voltage Detection or Over-voltage Detection

Error Code	U2
Method of Error Detection	<p>Low-voltage detection: An abnormal voltage drop is detected by the DC voltage detection circuit.</p> <p>Over-voltage detection: An abnormal voltage rise is detected by the DC over-voltage detection circuit.</p>
Error Decision Conditions	<p>Low-voltage detection:</p> <ul style="list-style-type: none"> ■ The voltage detected by the DC voltage detection circuit is below 180 - 196 V (depending on the model). ■ The compressor stops if the error occurs, and restarts automatically after 3-minute standby. <p>Over-voltage detection:</p> <ul style="list-style-type: none"> ■ An over-voltage signal is fed from the over-voltage detection circuit to the microcomputer. ■ The compressor stops if the error occurs, and restarts automatically after 3-minute standby.
Supposed Causes	<ul style="list-style-type: none"> ■ Power supply voltage out of specification ■ Defective DC voltage detection circuit ■ Defective over-voltage detection circuit ■ Defective PAM control part ■ Disconnection of compressor harness ■ Short circuit inside the fan motor winding ■ Noise ■ Momentary drop of voltage ■ Momentary power failure ■ Defective outdoor unit PCB

Troubleshooting

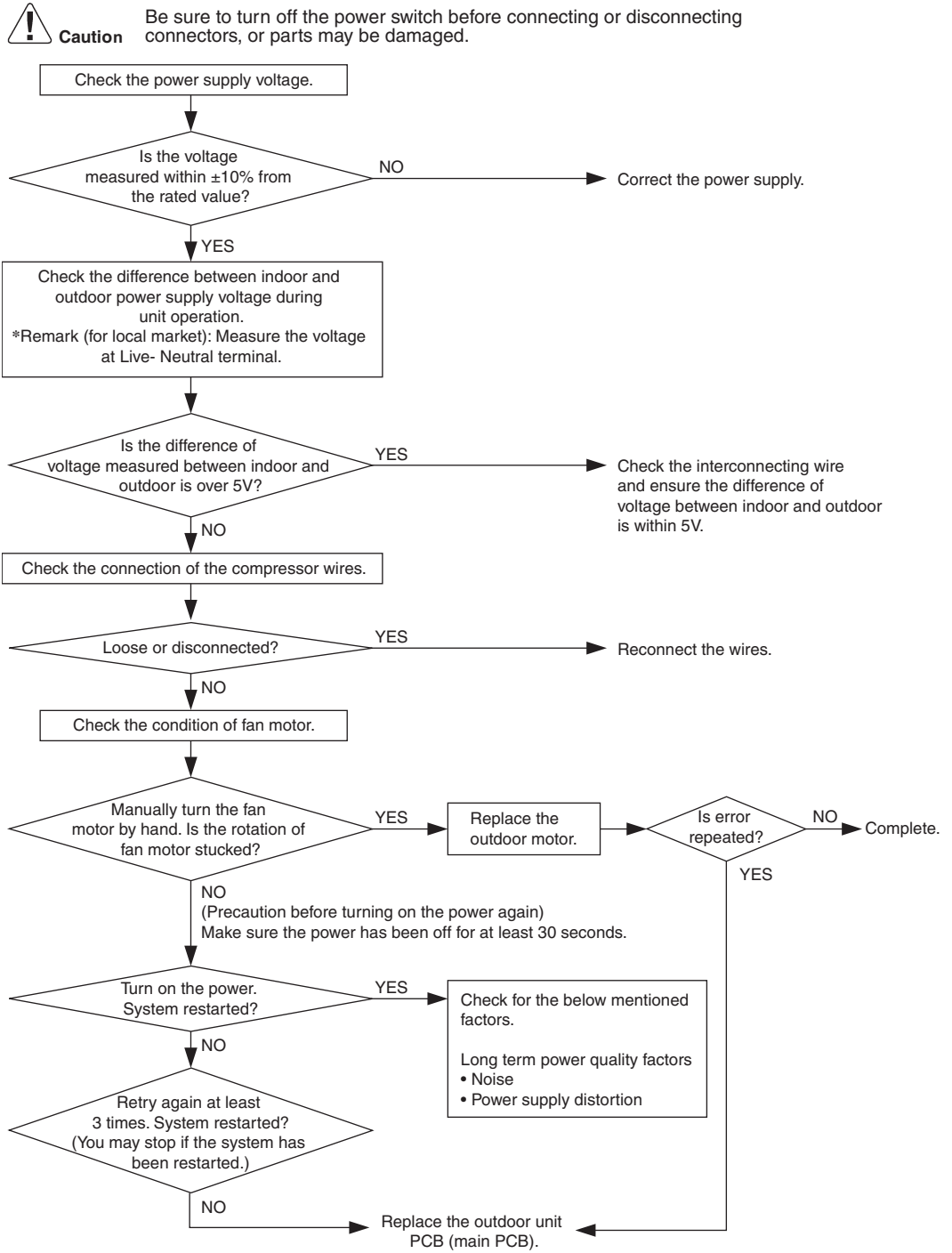

4.8 Signal Transmission Error (Between Indoor Unit and Outdoor Unit)

Error Code	U4
Method of Error Detection	The signal transmission data received from the outdoor unit is checked whether it is normal.
Error Decision Conditions	The data sent from the outdoor unit cannot be received normally, or the content of the data is abnormal.
Possible Root Cause	<ol style="list-style-type: none">1. Power Supply Abnormal2. Wrong wiring of connecting wires / wire breaking3. Defective of Indoor/ Outdoor PCB

Troubleshooting

Caution Be sure to turn off the power switch before connecting or disconnecting connectors, or parts may be damaged.

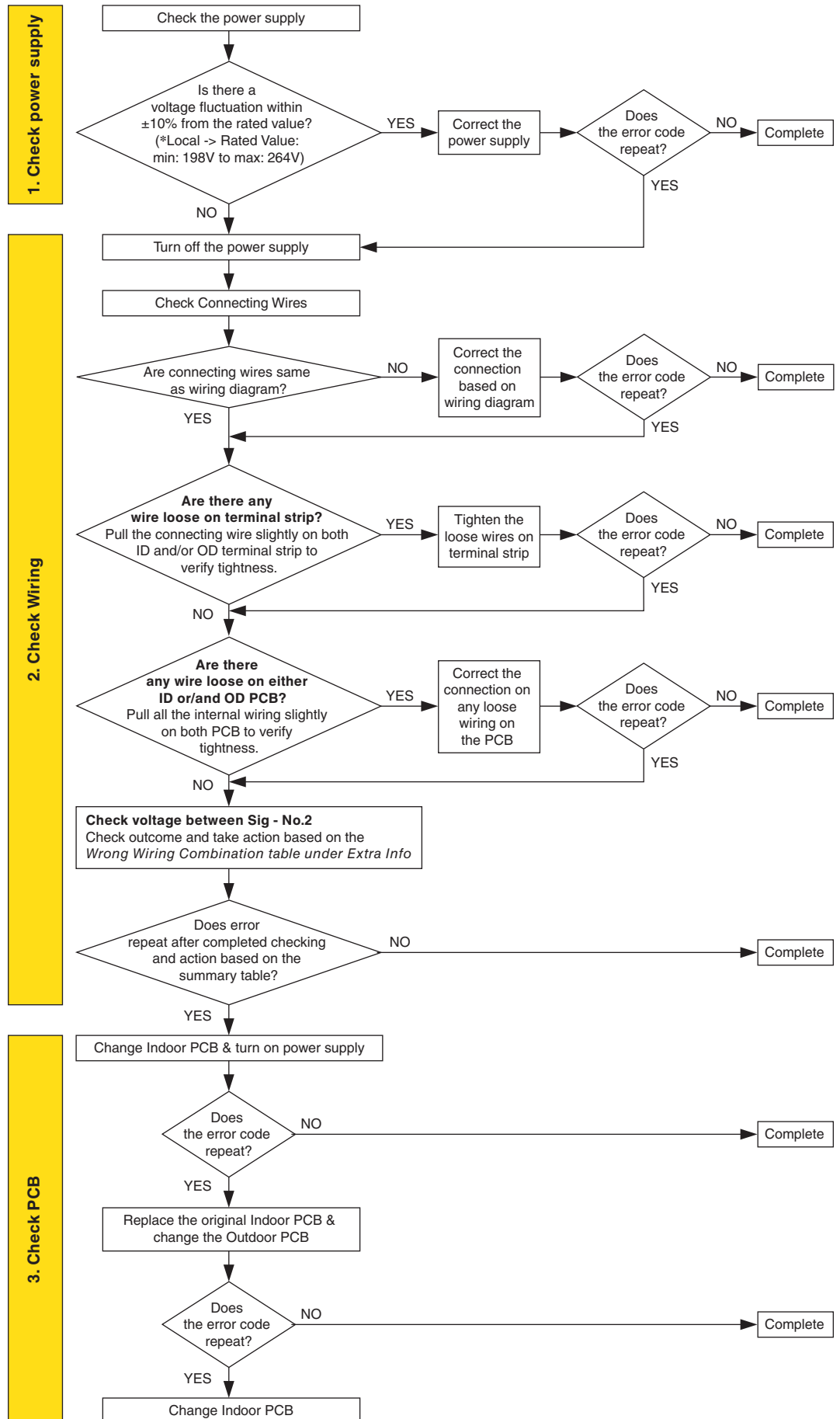

Extra Info:

Wrong Wiring Combination Table

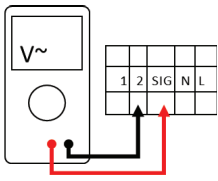

No	Combination	Model		Voltage at 2-3/SIG	Action to be taken
		FTKU / FTKH	FTKF		
1	Correct Wiring	-		5 - 20 VAC	-
2	Wrong Wiring	-		0 VAC or 230 VAC	Correct the wiring as per wiring diagram
3		U4	U4	0 VAC	
4		U4	-	230 VAC	
5		U4	U4	230 VAC	

4.9 Installation error

Error Code	UA
Method of Error Detection	The supply power is detected for its requirements (pair type is different from multi type) by the indoor/outdoor transmission signal.
Error Decision Conditions	The pair type and multi type are interconnected.
Possible root cause	<ol style="list-style-type: none">1. Wrong wiring of connecting wires.2. Model coupling error.

Troubleshooting

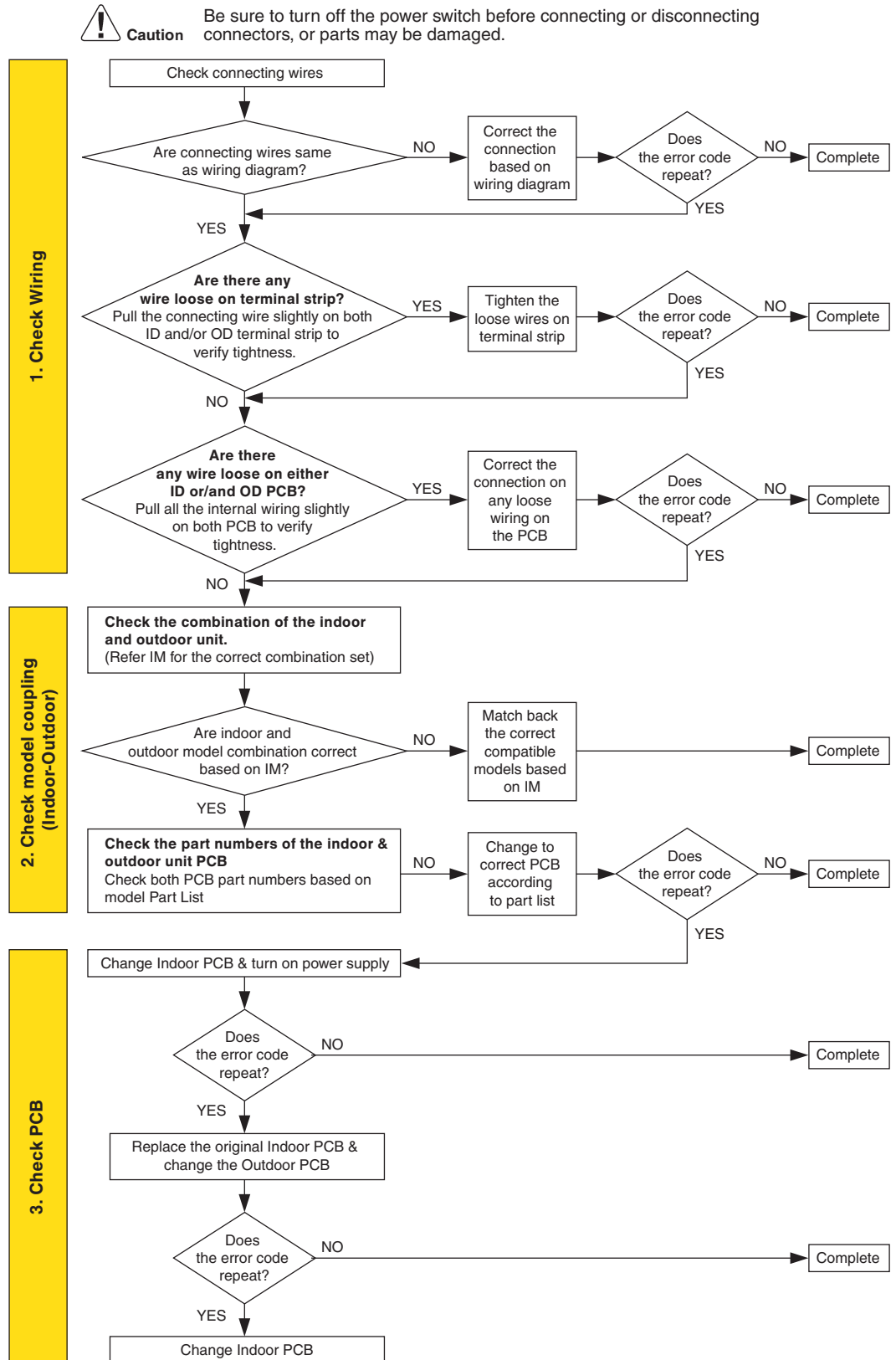

Extra Info:

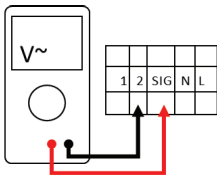

No	Combination	Model		Voltage at 2-3/SIG	Action to be taken
		FTKU / FTKH	FTKF		
1	Correct Wiring	-		5 - 20 VAC	-
2	Wrong Wiring	UA	UA	0 VAC or 230 VAC	Correct the wiring as per wiring diagram
3		UA	UA	230 VAC	
4		UA	UA	~50 VAC or 230 VAC	

4.10 Outdoor Unit PCB Abnormality

Error Code	E1
Method of Error Detection	<ul style="list-style-type: none"> ■ The system checks if the microcomputer is working in order. ■ The system checks if the zero-cross signal comes in properly.
Error Decision Conditions	<ul style="list-style-type: none"> ■ The microcomputer program runs out of control. ■ The zero-cross signal is not detected.
Supposed Causes	<ul style="list-style-type: none"> ■ Defective outdoor unit PCB ■ Noise ■ Momentary drop of voltage ■ Momentary power failure

Troubleshooting

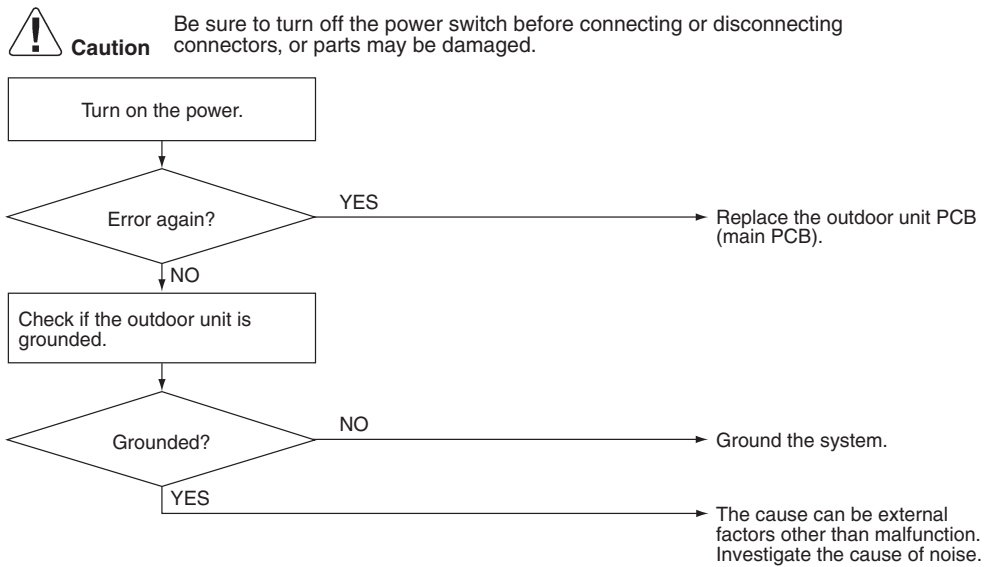

4.11 Actuation of High Pressure Switch

Error Code	E3
Applicable Models	Class 18/24
Method of Error Detection	Abnormality is detected when the contact of the high pressure switch opens.
Error Decision Conditions	<ul style="list-style-type: none"> ■ High pressure switch (S1PH) activating pressure: 4.15 MPa ■ High pressure switch (S1PH) recovery pressure: 3.2 MPa
Supposed Causes	<ul style="list-style-type: none"> ■ Actuation of high pressure switch (S1PH) ■ Closed stop valve ■ Disconnection of connector S40 ■ Disconnection of 2 terminals of high pressure switch (S1PH) ■ Defective outdoor unit PCB ■ Broke S1PH harness ■ Defective high pressure switch (S1PH)

Troubleshooting



Caution

Be sure to turn off the power switch before connecting or disconnecting connectors, or parts may be damaged.

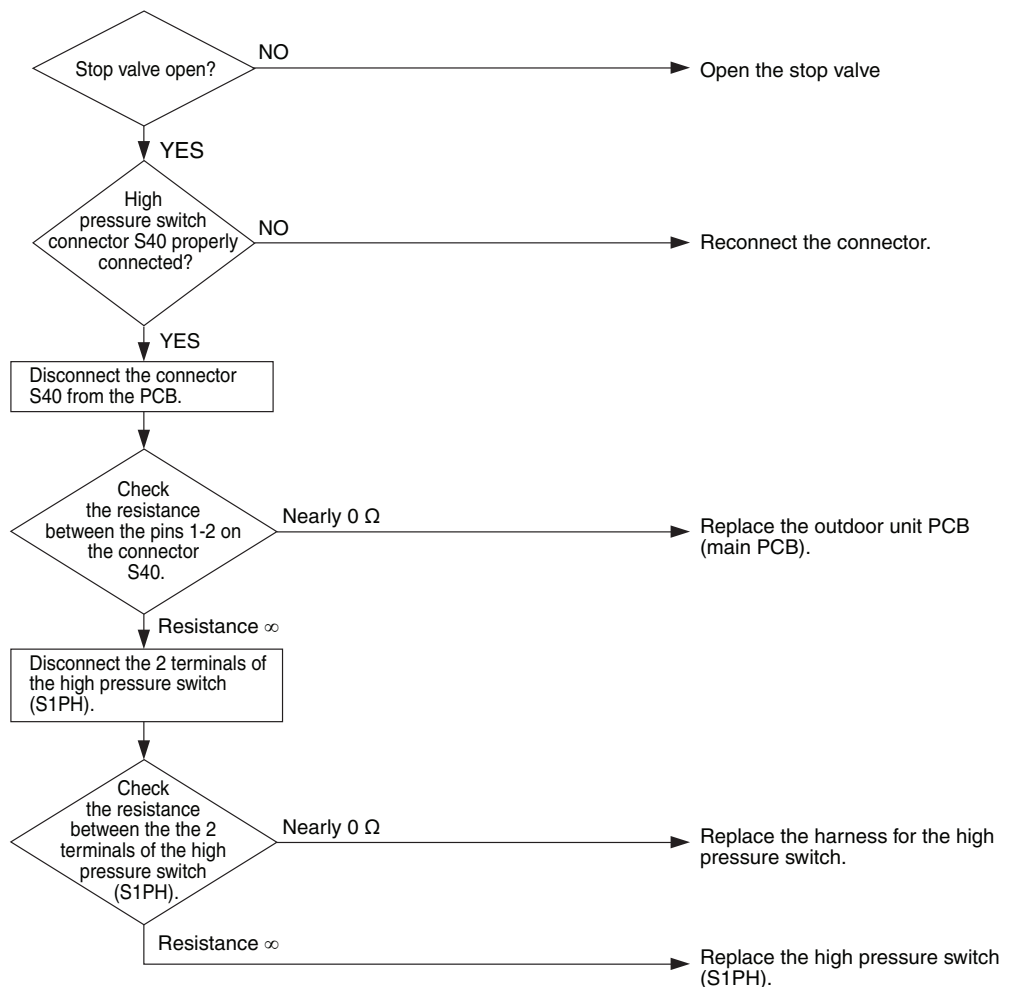

4.12 OL Activation (Compressor Overload)

Applicable Models	RXC18/24AXVJU
Error Code	E5
Method of Error Detection	Abnormality is detected when the contact of the high pressure switch opens.
Error Decision Conditions	<ul style="list-style-type: none"> ■ If the error repeats, the system is shut down. ■ Reset condition: Continuous run for about 60 minutes without any other error
Possible Root Causes	<ol style="list-style-type: none"> 1. Disconnection of discharge pipe thermistor 2. Defective discharge pipe thermistor 3. Disconnection of connector S40 4. Disconnection of 2 terminals of OL (Q1L) 5. Defective OL (Q1L) 6. Broken OL harness 7. Defective electronic expansion valve or coil 8. Defective four way valve or coil 9. Defective outdoor unit PCB 10. Refrigerant shortage 11. Water mixed in refrigerant 12. Defective stop valve

Troubleshooting

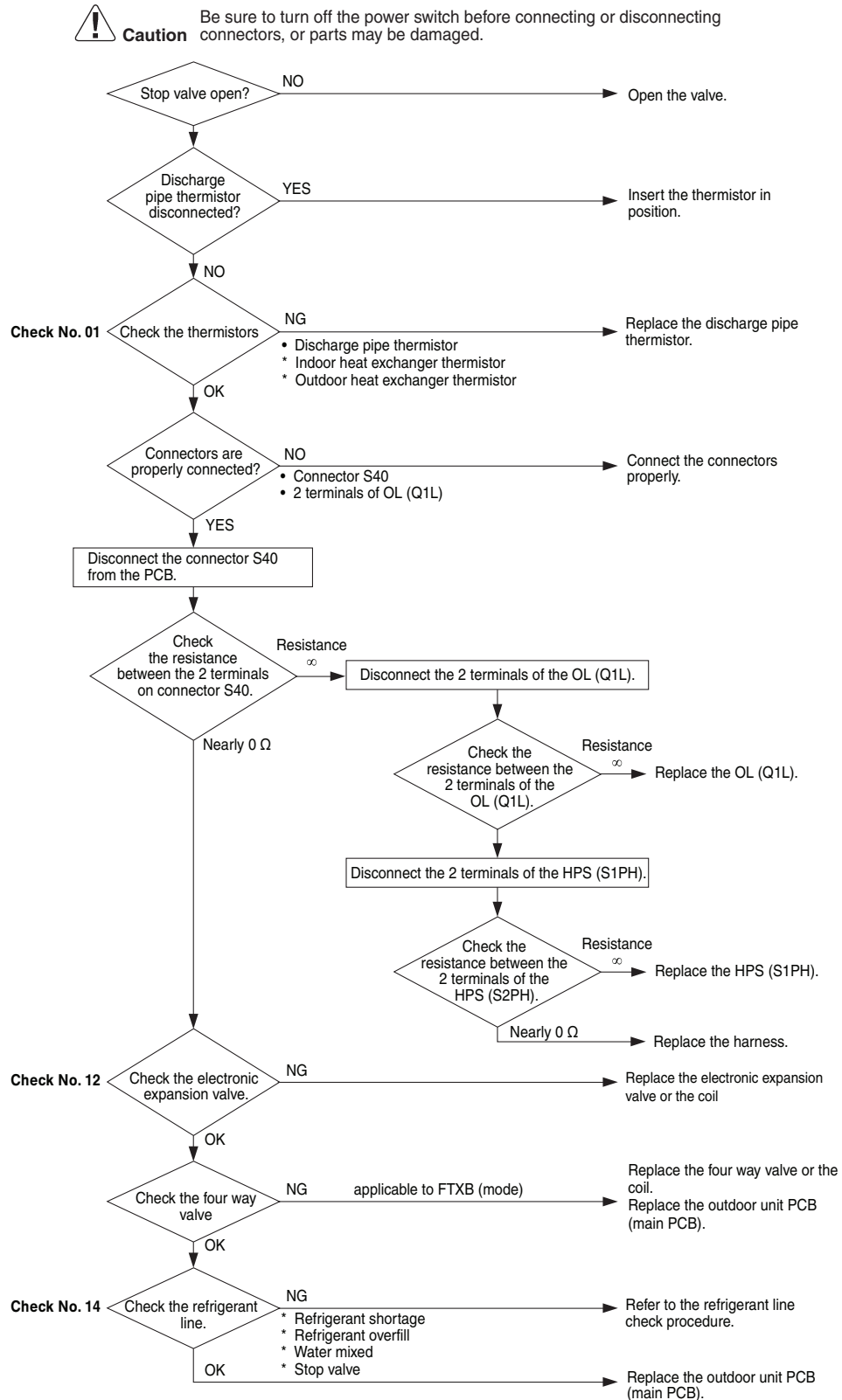

Reference

Check No.01 Refer to P.94



Reference

Check No.12 Refer to P.95



Reference

Check No.14 Refer to P.97



Note

When replacing the defective thermistor(s), replace the thermistor as ASSY.

4.13 OL Activation (Compressor Overload) or HPS Activation (High Pressure Switch)

Error Code	E5
Applicable Models	Class 09 and Class 12
Description	OL activation (compressor overload).
Method of Error Detection	A compressor overload is detected through compressor OL. Abnormality is detected when the contact of the high pressure switch opens.
Error Decision Conditions	<ul style="list-style-type: none"> ■ If the error repeats, the system is shut down. ■ Reset condition: Continuous run for about 60 minutes without any other error
Possible Root Causes	<ol style="list-style-type: none"> 1. Disconnection of discharge pipe thermistor 2. Defective discharge pipe thermistor 3. Disconnection of connector S40 4. Disconnection of 2 terminals of OL (Q1L) 5. Defective OL (Q1L) 6. Broken OL harness 7. Defective electronic expansion valve or coil 8. Defective four way valve or coil 9. Defective outdoor unit PCB 10. Refrigerant shortage 11. Water mixed in refrigerant 12. Defective stop valve 13. Defective outdoor unit PCB 14. Refrigerant shortage 15. Water mixed in refrigerant 16. Defective stop valve

Troubleshooting

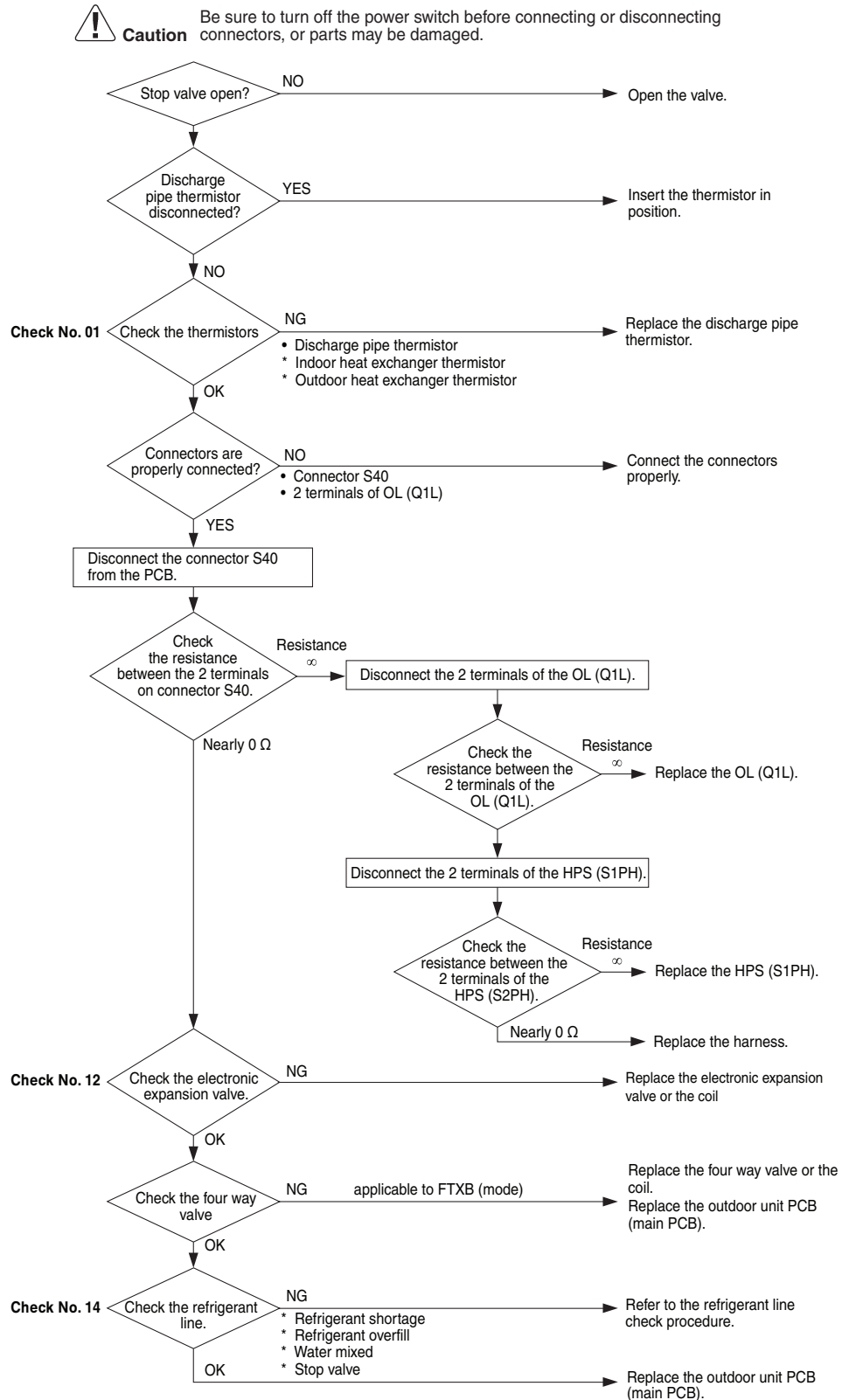

Reference

Check No.01 Refer to P.94



Reference

Check No.12 Refer to P.95



Reference

Check No.14 Refer to P.97



Note

When replacing the defective thermistor(s), replace the thermistor as ASSY.

4.14 Compressor Lock

Error Code	E6
Description	Compressor lock.
Method of Error Detection	A compressor lock is detected by checking the compressor running condition through the position detection circuit.
Error Decision Conditions	<ul style="list-style-type: none"> ■ If the error repeats, the system is shut down. ■ Reset condition: Continuous run for about 11 minutes without any other error.
Supposed Causes	<ul style="list-style-type: none"> ■ Closed stop valve ■ Compressor locked ■ Disconnection of compressor harness

Troubleshooting

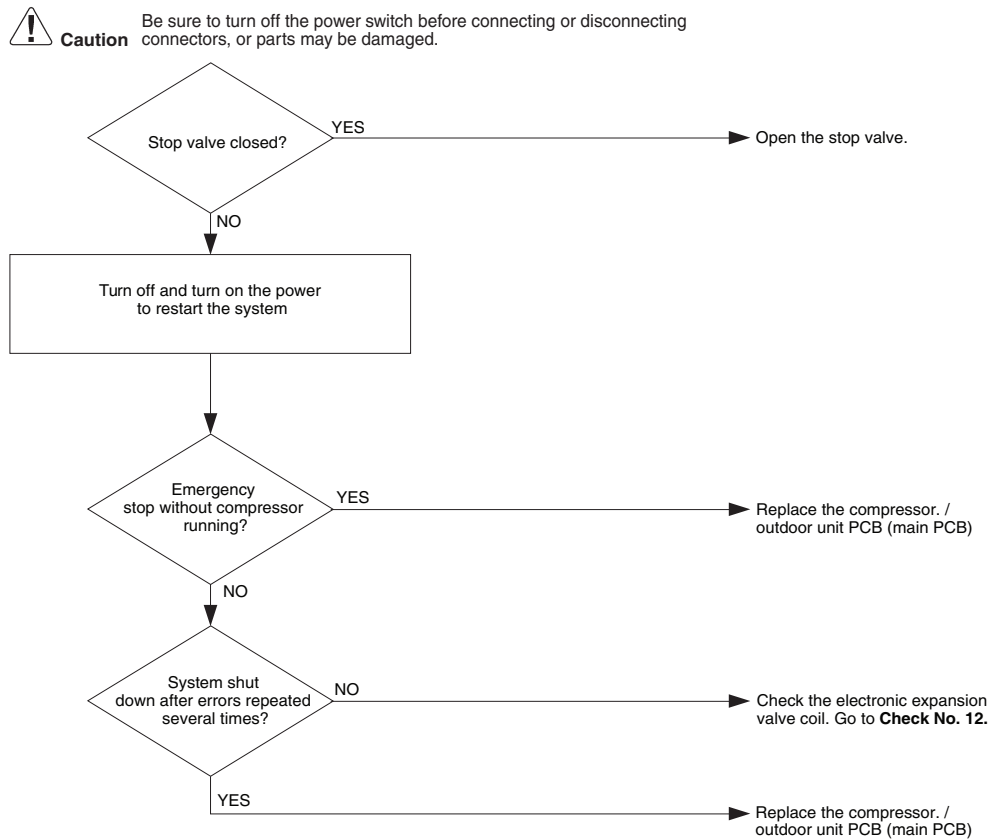

Reference

Check No.12 Refer to P.95

4.15 DC Fan Lock

Error Code	E7
Method of Error Detection	An error is determined with the high-voltage fan motor rotation speed detected by the Hall IC.
Error Decision Conditions	<ul style="list-style-type: none"> ■ The fan does not start in about 30 ~ 60 seconds (depending on the model) even when the fan motor is running. ■ If the error repeats, the system is shut down. ■ Reset condition: Continuous run for about 11 minutes without any other error
Supposed Causes	<ul style="list-style-type: none"> ■ Disconnection of the fan motor ■ Foreign matter stuck in the fan ■ Defective fan motor ■ Defective outdoor unit PCB

Troubleshooting

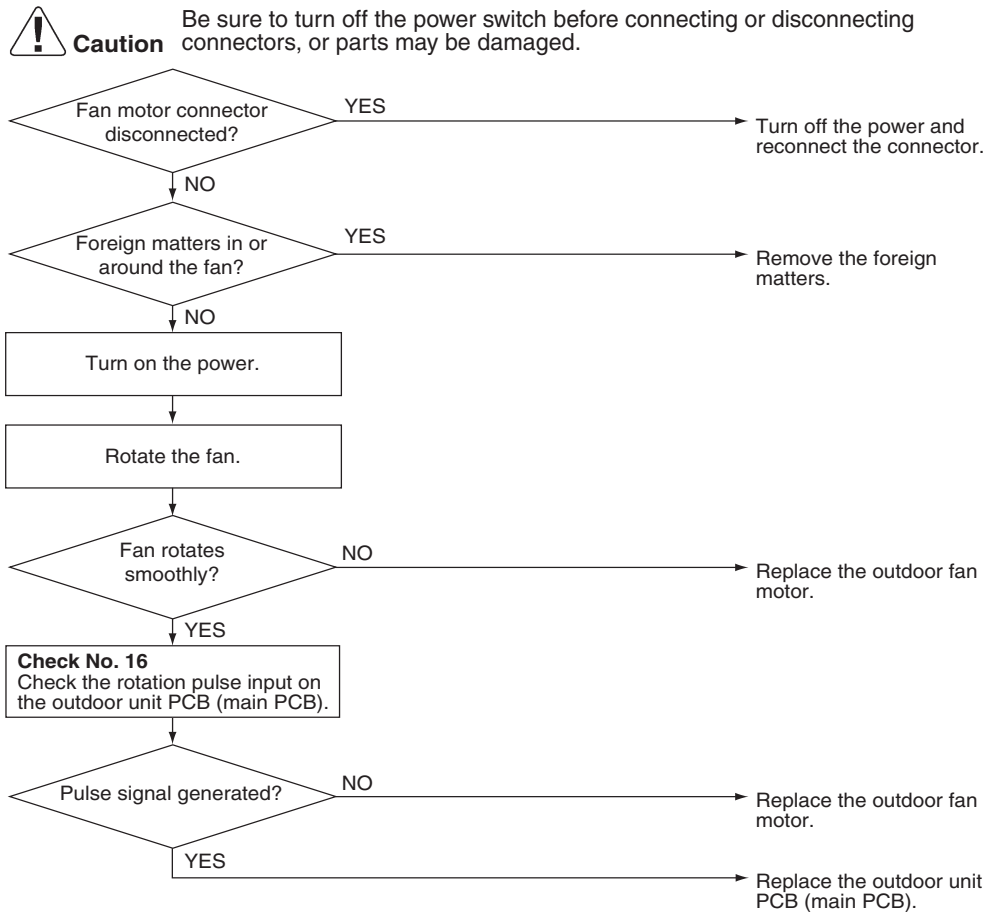

Reference

Check No.16 Refer to P.97

4.16 Input Overcurrent Detection

Error Code	E8
Description	Input Overcurrent Detection
Method of Error Detection	An input overcurrent is detected by checking the input current value with the compressor running.
Error Decision Conditions	<ul style="list-style-type: none"> ■ The current exceeds 13 ~ 16 A (depending on the model) for 2.5 seconds with the compressor running. ■ The upper limit of the current decreases when the outdoor temperature exceeds a certain level.
Supposed Causes	<ul style="list-style-type: none"> ■ Outdoor temperature out of operation range ■ Defective compressor ■ Defective power module ■ Defective outdoor unit PCB ■ Short circuit

Troubleshooting

 **Caution** Be sure to turn off the power switch before connecting or disconnecting connectors, or parts may be damaged.

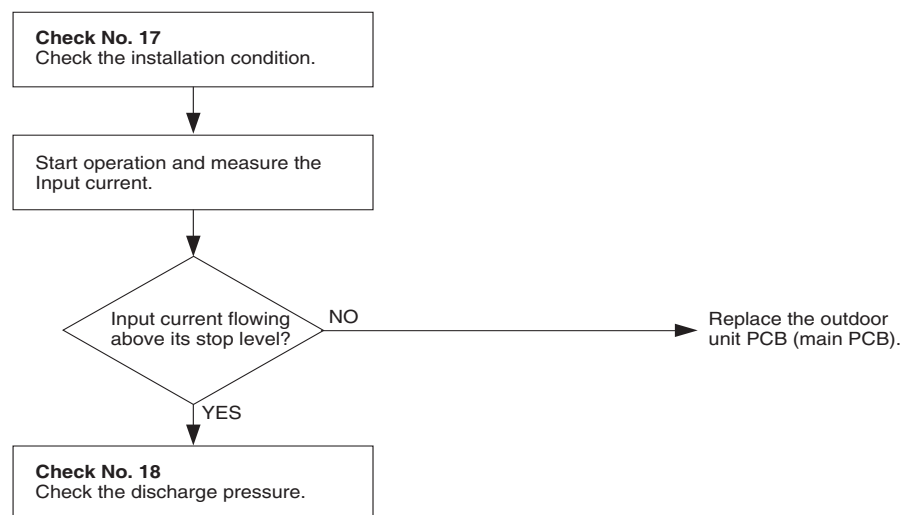

Cautions:

- Be sure to turn off the power switch before connecting or disconnecting connectors, or parts may be damaged.
- An input overcurrent may result from wrong internal wiring. If the system is interrupted by an input overcurrent after the wires have been disconnected and reconnected for part displacement, check the wiring again.



Reference

Check No.17 Refer to P.99



Reference

Check No.18 Refer to P.99

4.17 Discharge Pipe Temperature Control

Error Code F3

Method of Error Detection An error is determined with the temperature detected by the discharge pipe thermistor.

Error Decision Conditions

- If the temperature detected by the discharge pipe thermistor rises above A°C (°F), the compressor stops.
- The error is cleared when the discharge pipe temperature has dropped below B°C (°F).
- If the error repeats, the system is shut down.
- Reset condition: Continuous run for about 60 minutes without any other error

	Class	
	09/12	18/24
Maximum Limit, A (°C)	110	118
Reset Limit, B (°C)	88	81

	Class	
	09/12	18/24
Maximum Limit, A (°F)	230	231.8
Reset Limit, B (°F)	190.4	165.2

Supposed Causes

- Defective discharge pipe thermistor (Defective outdoor heat exchanger thermistor or outdoor temperature thermistor)
- Defective electronic expansion valve or coil
- Refrigerant shortage
- Water mixed in refrigerant
- Defective stop valve
- Defective outdoor unit PCB

Troubleshooting

 **Caution** Be sure to turn off the power switch before connecting or disconnecting connectors, or parts may be damaged.

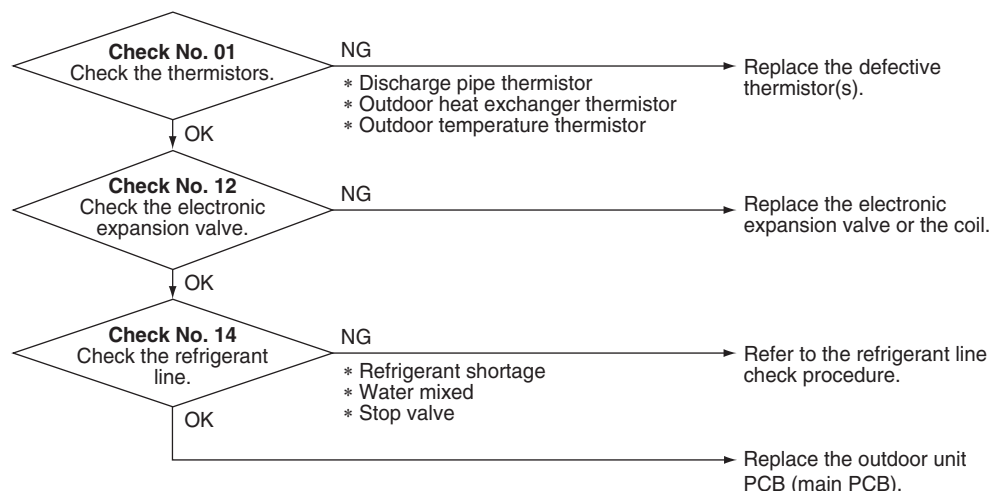

 **Reference** **Check No.01** Refer to P.94

 **Reference** **Check No.12** Refer to P.95

 **Reference** **Check No.14** Refer to P.97

 **Note** When replacing the defective thermistor(s), replace the thermistor as ASSY.

4.18 High Pressure Control in Cooling

Error Code	F6												
Method of Error Detection	High-pressure control (operation halt, frequency drop, etc.) is activated in cooling mode if the temperature sensed by the outdoor heat exchanger thermistor exceeds the limit.												
Error Decision Conditions	<ul style="list-style-type: none"> ■ The temperature sensed by the outdoor heat exchanger thermistor rises above A°C (°F). ■ The error is cleared when the temperature drops below B°C (°F). 												
	<table border="1"> <thead> <tr> <th rowspan="2"></th> <th colspan="2">Class</th> </tr> <tr> <th>09/12</th> <th>18/24</th> </tr> </thead> <tbody> <tr> <td>Maximum Limit, A (°C)</td> <td>58</td> <td>61</td> </tr> <tr> <td>Reset Limit, B (°C)</td> <td>48</td> <td>53</td> </tr> </tbody> </table>			Class		09/12	18/24	Maximum Limit, A (°C)	58	61	Reset Limit, B (°C)	48	53
	Class												
	09/12	18/24											
Maximum Limit, A (°C)	58	61											
Reset Limit, B (°C)	48	53											
	<table border="1"> <thead> <tr> <th rowspan="2"></th> <th colspan="2">Class</th> </tr> <tr> <th>09/12</th> <th>18/24</th> </tr> </thead> <tbody> <tr> <td>Maximum Limit, A (°F)</td> <td>136.4</td> <td>141.8</td> </tr> <tr> <td>Reset Limit, B (°F)</td> <td>118.4</td> <td>127.4</td> </tr> </tbody> </table>			Class		09/12	18/24	Maximum Limit, A (°F)	136.4	141.8	Reset Limit, B (°F)	118.4	127.4
	Class												
	09/12	18/24											
Maximum Limit, A (°F)	136.4	141.8											
Reset Limit, B (°F)	118.4	127.4											
Supposed Causes	<ul style="list-style-type: none"> ■ Installation space not large enough ■ Dirty outdoor heat exchanger ■ Defective outdoor fan motor ■ Defective stop valve ■ Defective electronic expansion valve or coil ■ Defective outdoor heat exchanger thermistor ■ Defective outdoor unit PCB 												

Troubleshooting

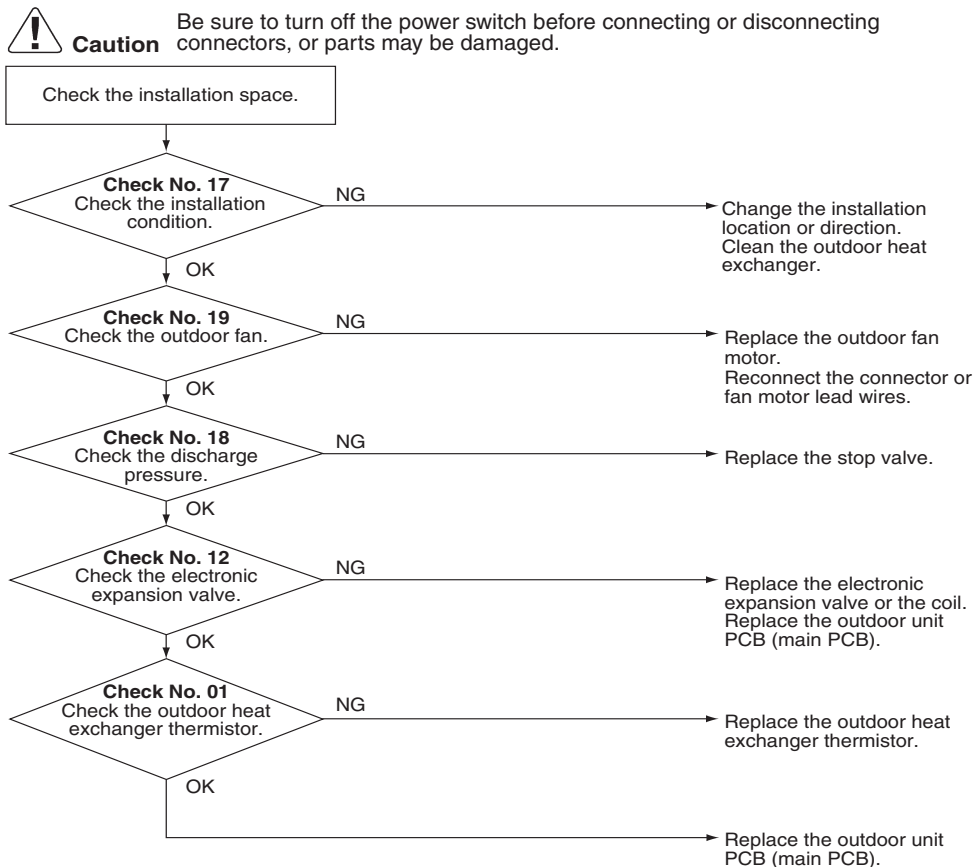



Reference **Check No.01** Refer to P.94



Reference **Check No.12** Refer to P.95



Reference **Check No.17** Refer to P.99



Reference **Check No.18** Refer to P.99



Reference **Check No.19** Refer to P.100



Note

When replacing the defective thermistor(s), replace the thermistor as ASSY.

4.19 Compressor System Sensor Abnormality

Error Code	H0
Method of Error Detection	The system checks the DC current before the compressor starts.
Error Decision Conditions	<ul style="list-style-type: none"> ■ The voltage converted from the DC current before compressor start-up is out of the range 0.5 ~ 4.5 V. ■ The DC voltage before compressor start-up is below 50 V.
Supposed Causes	<ul style="list-style-type: none"> ■ Broken or disconnected harness ■ Defective outdoor unit PCB

Troubleshooting

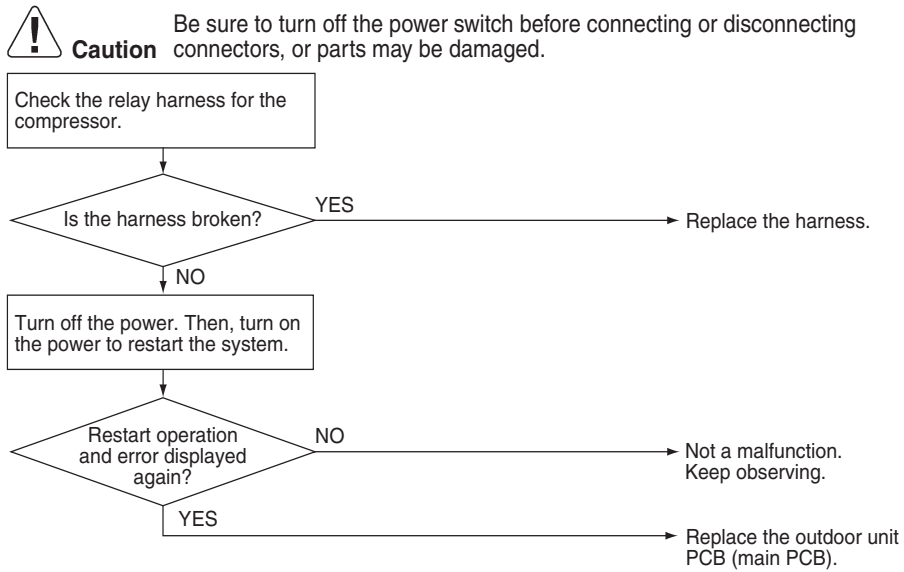

4.20 Position Sensor Abnormality

Error Code	H6
Description	Position Sensor Abnormality
Method of Error Detection	A compressor start-up failure is detected by checking the compressor running condition through the position detection circuit.
Error Decision Conditions	<ul style="list-style-type: none"> ■ The compressor fails to start in about 15 seconds after the compressor run command signal is sent. ■ If the error repeats, the system is shut down. ■ Reset condition: Continuous run for about 11 minutes without any other error
Supposed Causes	<ul style="list-style-type: none"> ■ Power supply voltage out of specification ■ Disconnection of the compressor harness ■ Defective compressor ■ Defective outdoor unit PCB ■ Start-up failure caused by the closed stop valve ■ Input voltage out of specified range

Troubleshooting

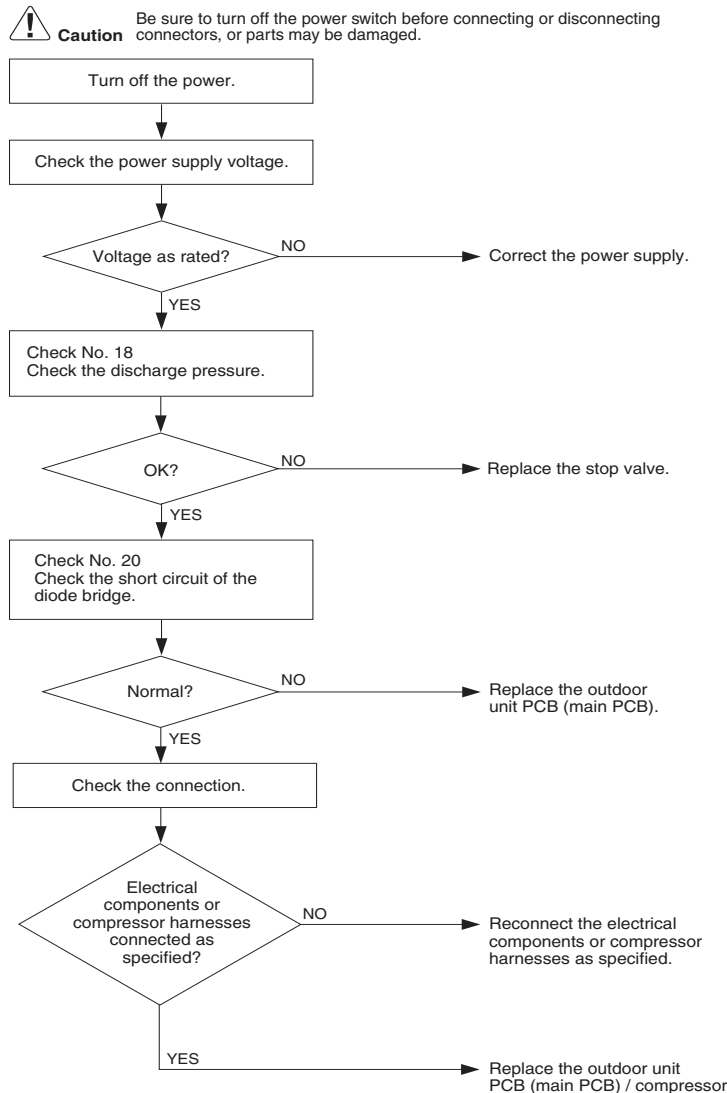

 **Reference** **Check No.18** Refer to P.99

 **Reference** **Check No.20** Refer to P.100

4.21 Thermistor or Related Abnormality (Outdoor Unit)

Error Code	H9, J3, J6 and P4
Description	Thermistor or Related Abnormality (Outdoor Unit)
Method of Error Detection	This fault is identified based on the thermistor input voltage to the microcomputer. A thermistor fault is identified based on the temperature sensed by each thermistor.
Error Decision Conditions	<ul style="list-style-type: none"> ■ The voltage between both ends of the thermistor is either 4.96 V or more, or 0.04 V or less with the power on. ■ J3 error is judged if the discharge pipe temperature is lower than the heat exchanger temperature.
Possible Root Causes	<ul style="list-style-type: none"> ■ Disconnection of the connector for the thermistor ■ Defective thermistor(s) ■ Defective outdoor heat exchanger thermistor in the case of J3 error ■ Defective outdoor unit PCB

Troubleshooting



In case of P4 (Radiation fin thermistor)
Be sure to turn off the power switch before connecting or disconnecting connectors, or parts may be damaged.
Replace the outdoor unit PCB (main PCB)

Troubleshooting



In case of H9, J3, J6 and P4
Be sure to turn off the power switch before connecting or disconnecting connectors, or parts may be damaged.

Caution Be sure to turn off the power switch before connecting or disconnecting connectors, or parts may be damaged.

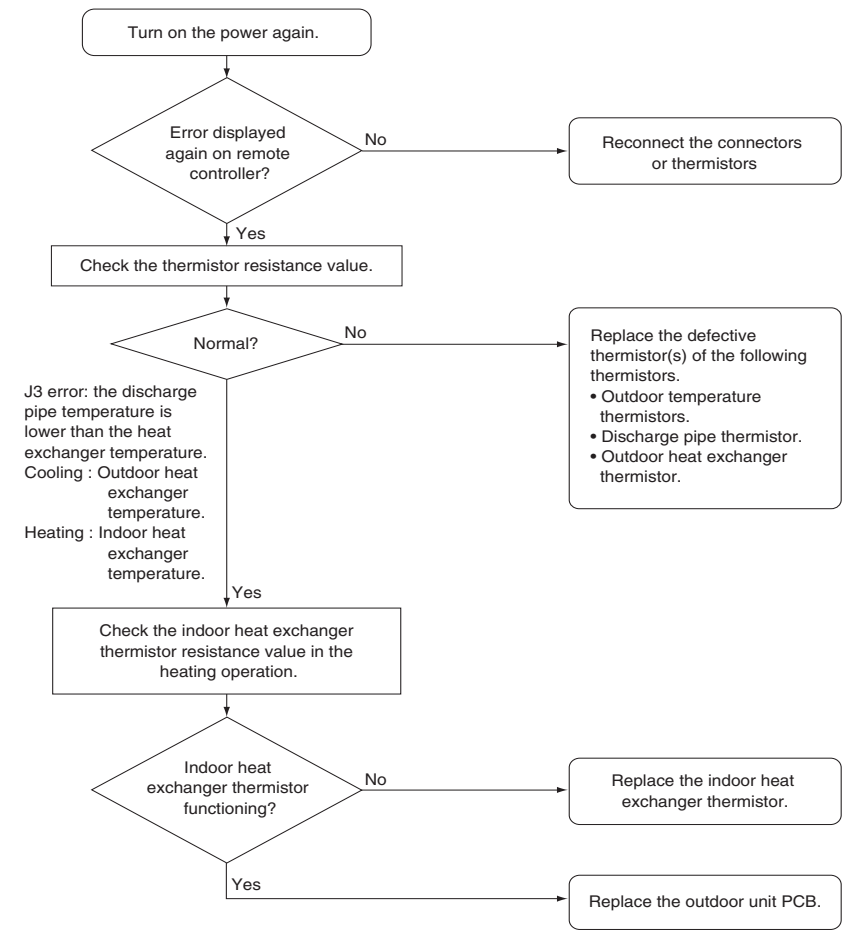

H9 : Outdoor temperature thermistor

**Reference****Check No.01** Refer to P.94**Note**

When replacing the defective thermistor(s), replace the thermistor as ASSY.

4.22 Electrical Box Temperature Rise

Error Code	L3		
Method of Error Detection	An electrical box temperature rise is detected by checking the radiation fin thermistor with the compressor off.		
Error Decision Conditions	<ul style="list-style-type: none"> ■ With the compressor off, the radiation fin temperature is above A °C (°F). ■ The error is cleared when the radiation fin temperature drops below B °C (°F). ■ To cool the electrical components, the outdoor fan starts when the radiation fin temperature rises above C °C and stops when the radiation fin temperature drops below B °C (°F). 		
	A (°C)	B (°C)	C (°C)
09/12	93	70	78
18/24	122	64	113
	A (°F)	B (°F)	C (°F)
09/12	199.4	158	172.4
18/24	251.6	147.2	235.4
Supposed Causes	<ul style="list-style-type: none"> ■ Defective outdoor fan motor ■ Short circuit ■ Defective radiation fin thermistor ■ Disconnection of connector ■ Defective outdoor unit PCB 		

Troubleshooting

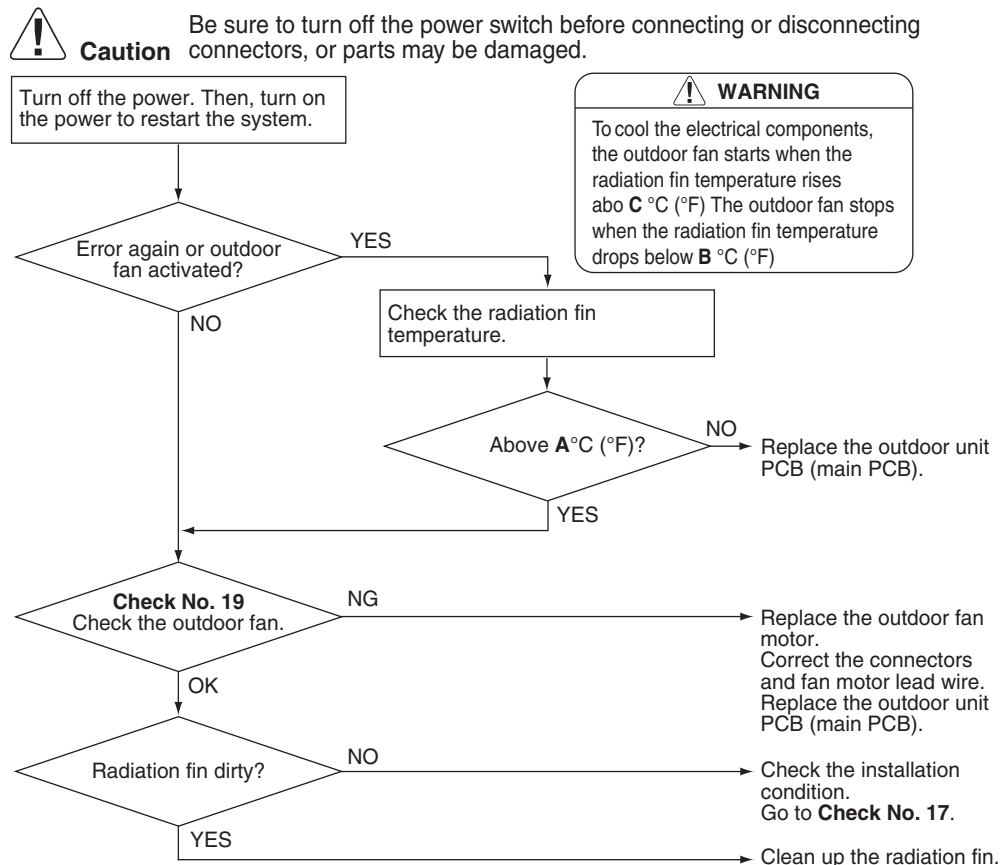

Reference **Check No.17** Refer to P.99

Reference **Check No.19** Refer to P.100

4.23 Radiation Fin Temperature Rise

Error Code	L4									
Method of Error Detection	A radiation fin temperature rise is detected by checking the radiation fin temperature with the compressor on.									
Error Decision Conditions	<ul style="list-style-type: none"> ■ The radiation fin temperature with the compressor on is above A °C (°F). ■ The error is cleared when the radiation fin temperature drops below B °C (°F). ■ If the error repeats, the system is shut down. ■ Reset condition: Continuous run for about 60 minutes without any other error 									
	<table border="1" style="margin: auto;"> <thead> <tr> <th colspan="2">Class</th> </tr> <tr> <th>09/12</th> <th>18/24</th> </tr> </thead> <tbody> <tr> <td>Maximum Limit, A (°C)</td> <td>93</td> </tr> <tr> <td>Reset Limit, B (°C)</td> <td>78</td> </tr> </tbody> </table>		Class		09/12	18/24	Maximum Limit, A (°C)	93	Reset Limit, B (°C)	78
Class										
09/12	18/24									
Maximum Limit, A (°C)	93									
Reset Limit, B (°C)	78									
	<table border="1" style="margin: auto;"> <thead> <tr> <th colspan="2">Class</th> </tr> <tr> <th>09/12</th> <th>18/24</th> </tr> </thead> <tbody> <tr> <td>Maximum Limit, A (°F)</td> <td>199.4</td> </tr> <tr> <td>Reset Limit, B (°F)</td> <td>172.4</td> </tr> </tbody> </table>		Class		09/12	18/24	Maximum Limit, A (°F)	199.4	Reset Limit, B (°F)	172.4
Class										
09/12	18/24									
Maximum Limit, A (°F)	199.4									
Reset Limit, B (°F)	172.4									
Supposed Causes	<ul style="list-style-type: none"> ■ Defective outdoor fan motor ■ Short circuit ■ Defective radiation fin thermistor ■ Disconnection of connector ■ Defective outdoor unit PCB ■ Silicone grease not applied properly on the radiation fin after replacing the outdoor unit PCB 									

Troubleshooting

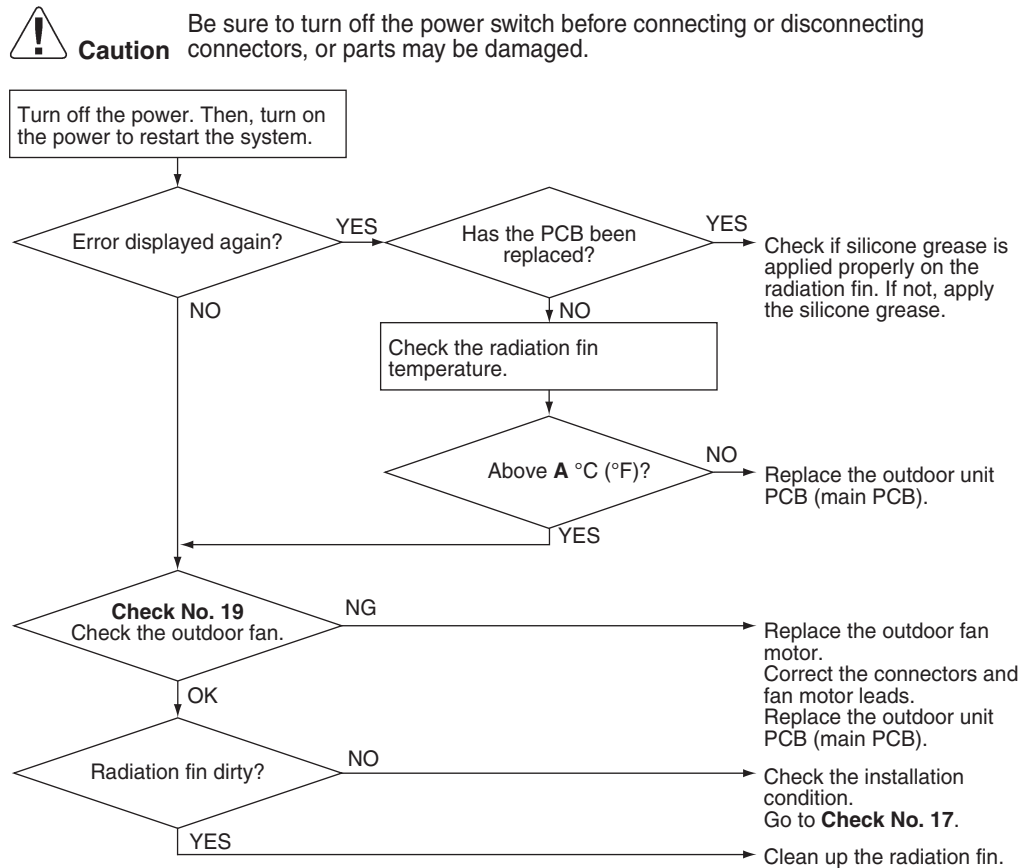



Reference Refer to Silicone Grease on Power Transistor/Diode Bridge on page 106 for details.



Reference **Check No.17** Refer to P.99



Reference **Check No.19** Refer to P.100

4.24 Output Overcurrent Detection

Error Code	L5
Description	Output Overcurrent Detection
Method of Error Detection	An output overcurrent is detected by checking the current that flows in the inverter DC section.
Error Decision Conditions	<ul style="list-style-type: none"> ■ A position signal error occurs while the compressor is running. ■ A rotation speed error occurs while the compressor is running. ■ An output overcurrent is fed from the output overcurrent detection circuit to the microcomputer. ■ If error repeats, the system is shut down. ■ Reset condition: Continuous run for about 5 minutes without any other error.
Possible root Causes	<ul style="list-style-type: none"> ■ Poor installation condition ■ Closed stop valve ■ Defective power module ■ Wrong internal wiring ■ Abnormal power supply voltage ■ Defective outdoor unit PCB ■ Power supply voltage out of installation ■ Defective compressor

Troubleshooting



Caution Be sure to turn off the power switch before connecting or disconnecting connectors, or parts may be damaged.

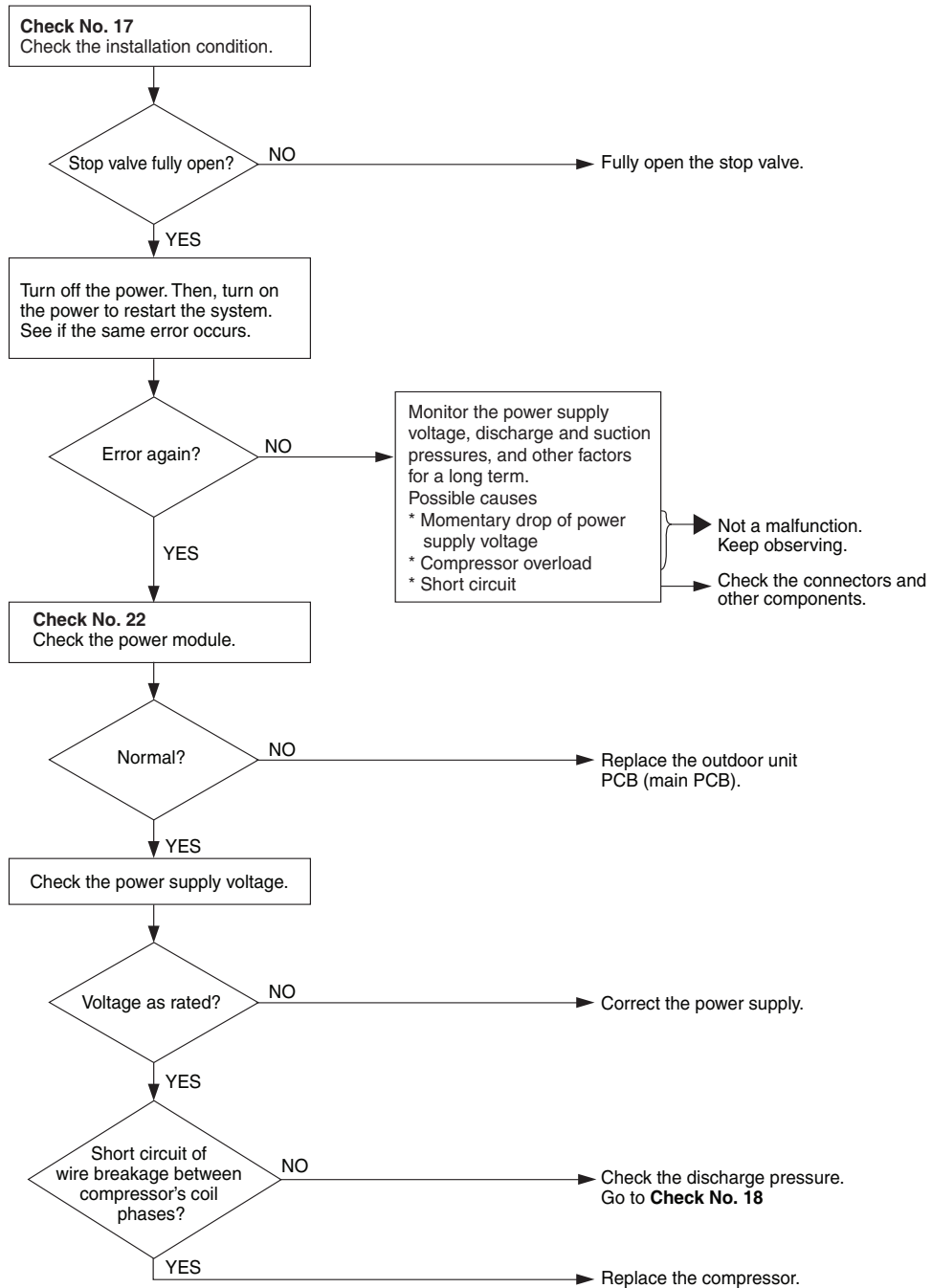

Reference Check No.17 Refer to P.99



Reference Check No.18 Refer to P.99



Reference Check No.22 Refer to P.102

4.25 Four Way Valve Abnormality

<p>Remote Controller Display</p>	<p>EA</p>
<p>Method of Malfunction Detection</p>	<p>The indoor air temperature thermistor, the indoor unit heat exchanger thermistor, the outdoor temperature thermistor and the outdoor unit heat exchanger thermistor are checked to see if the function within their normal ranges in the operating mode.</p>
<p>Malfunction Decision Conditions</p>	<p>A following condition continues over 10 minute after operating 5 minutes.</p> <ul style="list-style-type: none"> ■ Cooling / dry operation (room temp. - indoor heat exchanger temp.) < -5°C (23°F). ■ Heating (indoor unit heat exchanger temp. - room temp.) < -5°C (23°F).
<p>Supposed Causes</p>	<ul style="list-style-type: none"> ■ Connector in poor contact ■ Thermistor defective ■ Outdoor unit PCB defective ■ Four way valve coil or harness defective ■ Four way valve defective ■ Foreign substance mixed in refrigerant ■ Insufficient gas

Troubleshooting



Caution Be sure to turn off the power switch before connecting or disconnecting connectors, or parts may be damaged.

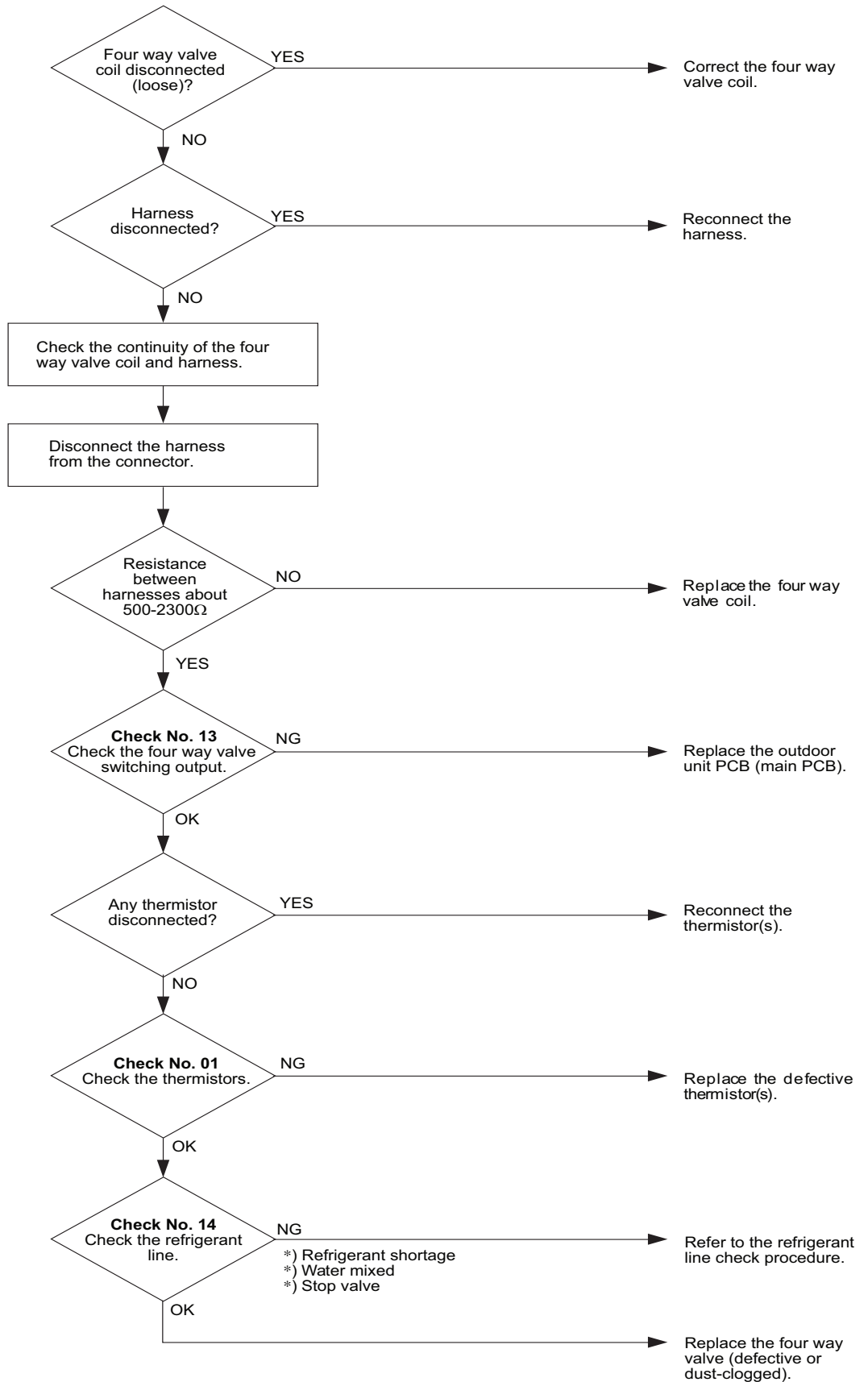

5. Actuator Check

5.1 Thermistor Resistance Check

Check No.01

Measure the resistance of each thermistor using multimeter.

The resistance values are defined by below table.

If the measured resistance value does not match the listed value, the thermistor must be replaced.

- Disconnect the connector of thermistor ASSY from the PCB to measure the resistance between the pins using multimeter.
- To check the thermistor soldered on a PCB, disconnect the PCB from other PCB/parts, and measure the resistance between the both ends of soldered thermistor.

Thermistor ASSY

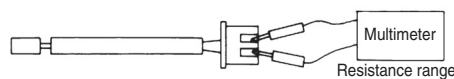

Soldered thermistor

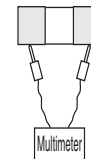

Thermistor temperature (°C)		Resistance (kΩ)	
°C	°F	Room temperature thermistor	Room temperature thermistor
-20	-4	73.4	197.8
-15	5	57.0	148.2
-10	14	44.7	112.1
-5	23	35.3	85.60
0	32	28.2	65.93
5	41	22.6	51.14
10	50	18.3	39.99
15	59	14.8	31.52
20	68	12.1	25.02
25	77	10.0	20.00
30	86	8.2	16.10
35	95	6.9	13.04
40	104	5.8	10.62
45	113	4.9	8.707
50	122	4.1	7.176

Thermistor		Resistance Type	R (25°C) or (77°F)
Indoor Unit	Room temperature thermistor	B	10 kΩ
	Indoor heat exchanger thermistor	B	10 kΩ
Outdoor Unit	Outdoor temperature thermistor	A	20 kΩ
	Outdoor heat exchanger thermistor	A	20 kΩ
	Discharge pipe thermistor	A	20 kΩ

Tolerance resistance type A : ±5%

Tolerance resistance type B : ±2%

5.2 Power Supply Waveform Check

Check No.11

Measure the power supply waveform between No. 1 and No. 2 on the terminal strip, and check the waveform disturbance.

- Check if the power supply waveform is a sine wave (Fig.1).
- Check if there is waveform disturbance near the zero-cross (sections circled in Fig.2).

[Fig.1]

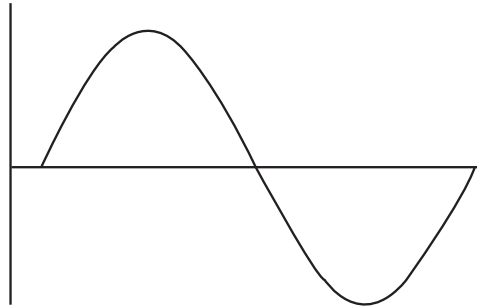

[Fig.2]

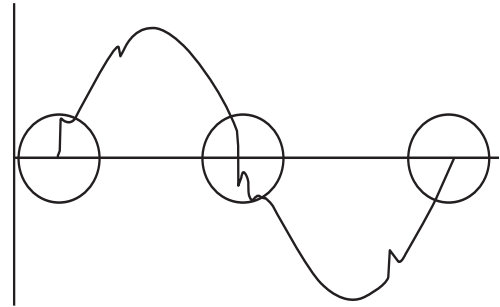

5.3 Electronic Expansion Valve Check

Check No.12

Conduct the followings to check the electronic expansion valve (EV).

1. Check if the EV connector is correctly connected to the PCB.
2. Turn the power off and on again, and check if the EV generates a latching sound.
3. If the EV does not generate a latching sound in the step 2 above, disconnect the connector and check the continuity using a multimeter.
4. Check the continuity between the pins 5 - 1, 5 - 2, 5 - 3, 5 - 4 (for 5P connectors) and 6 - 1, 6 - 3, 5 - 2, 5 - 4, (for 6P connectors). If there is no continuity between the pins, the EV coil is faulty.
5. If the continuity is confirmed in step 3, the outdoor unit PCB (main PCB) is faulty.

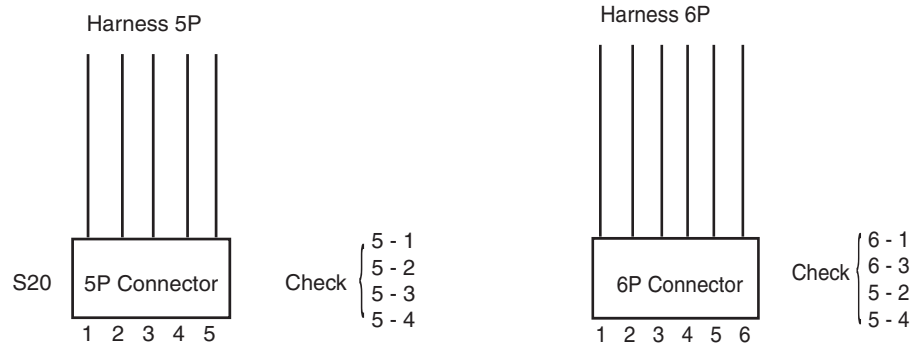

Class	09/12	18
	Harness 5P	Harness 6P

5.4 Four Way Valve Performance Check

Check No.13

Caution Be sure to turn off the power switch before connecting or disconnecting connectors, or parts may be damaged.

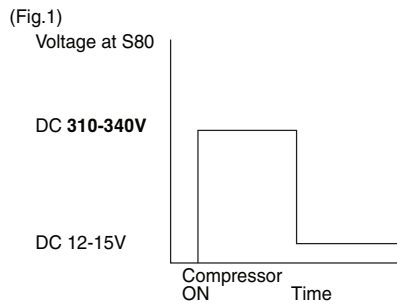
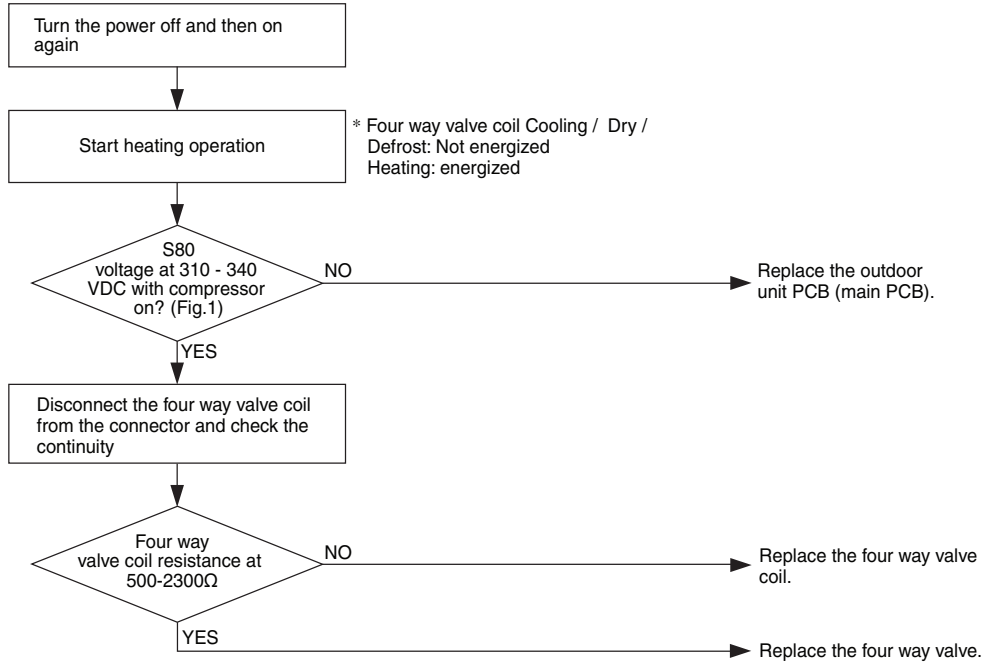

5.5 Inverter Unit Refrigerant System Check

Check No.14

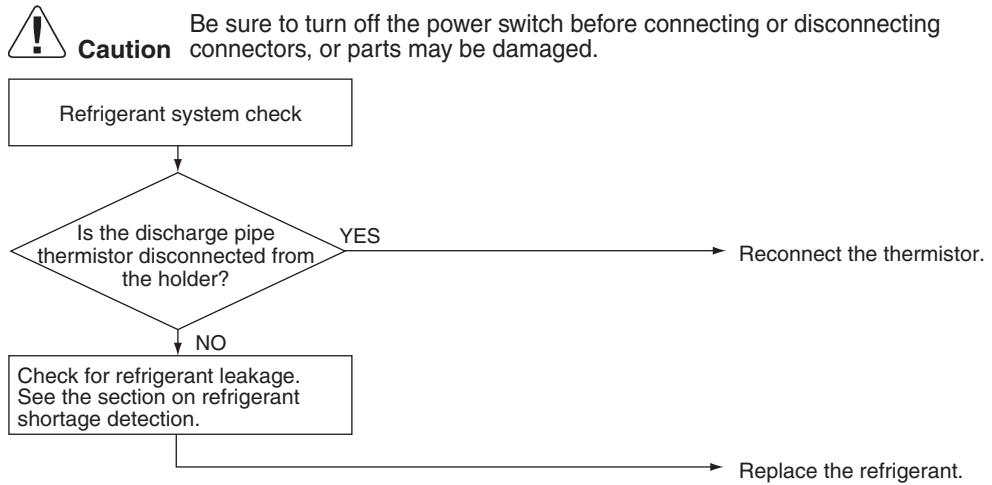

5.6 Rotation Pulse Check on the Outdoor Unit PCB

Check No.16

Class 09 and Class 12

Make sure that voltage supply of 208V/230 VAC are supplied to the unit.

1. Set operation off and power off. Disconnect the connector S71 and power on.
2. Check that the sensor voltage between the pins 11 - 10 is 5 VDC.
3. Ensure operation off and power off. Connect the connector S71 and power on.
4. Check whether rotation pulses (0 ~ 5 VDC) are output at the pins 12-10, 13-10 when the fan motor is rotated 1 turn by hand.
5. Ensure operation off and power off. Check the sinusoidal voltage is generated between pins 1-4 and 4-7 when the fan motor is manually rotated once.

When the fuse is melted, check the outdoor fan motor for proper function.

If NG in step 2 → Defective PCB → Replace the outdoor unit PCB (main PCB).

If NG in step 4 → Defective Hall IC → Replace the outdoor fan motor.

If NG in step 5 → Defective Fan Motor → Replace the outdoor fan motor.

If OK in all steps → Replace the outdoor unit PCB (main PCB).

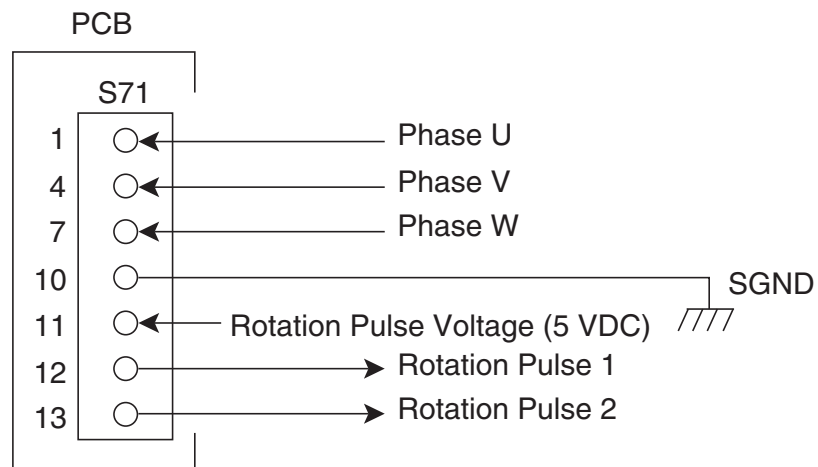

Class 18 and Class 24

Make sure that voltage supply of 208V/230 VAC are supplied to the unit.

1. Ensure operation off and power off. Check the sinusoidal voltage is generated between pins 1-3 and 3-5 when the fan motor is manually rotated once.

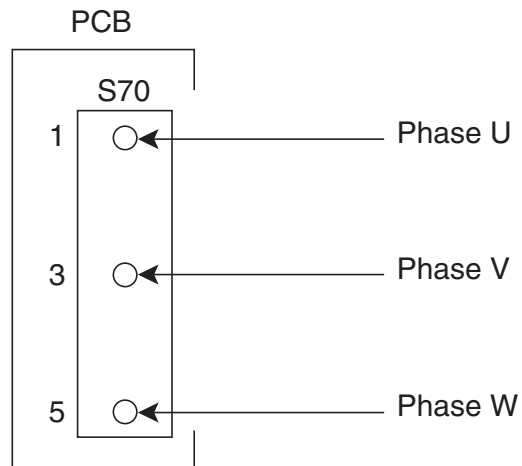

When the fuse is melted, check the outdoor fan motor for proper function.

If NG in step 1 → Defective Fan Motor → Replace the outdoor fan motor.

If OK in step 1 → Replace the outdoor unit PCB (main PCB).

5.7 Installation Condition Check

Check No.17

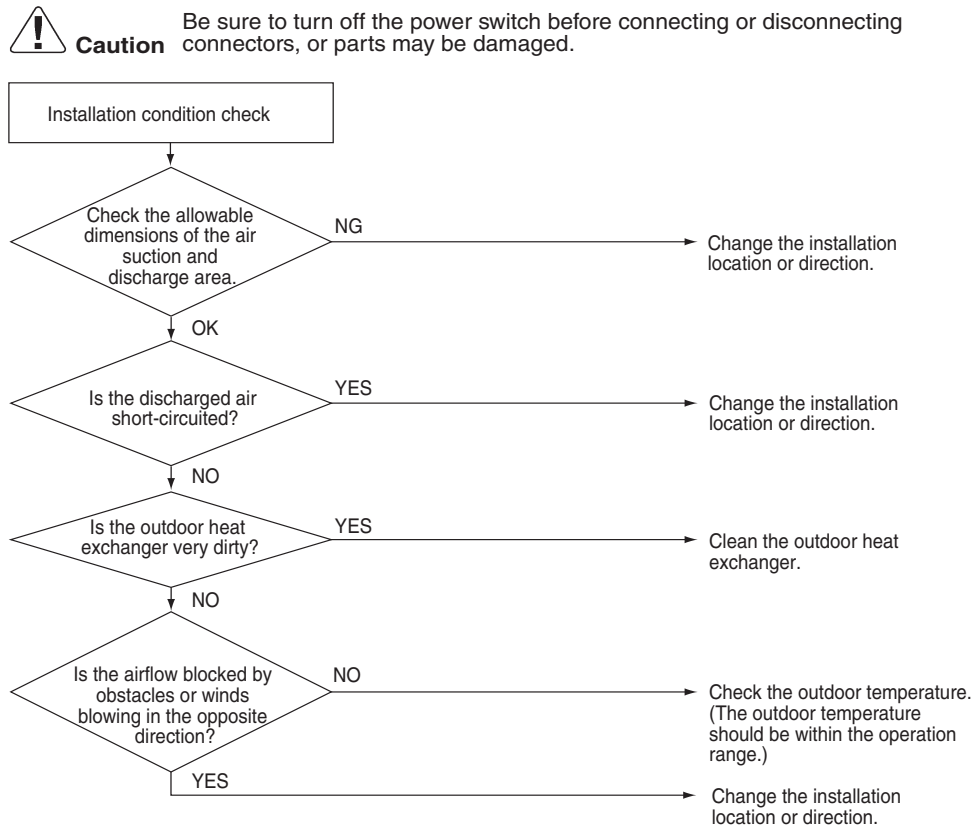

5.8 Discharge Pressure Check

Check No.18

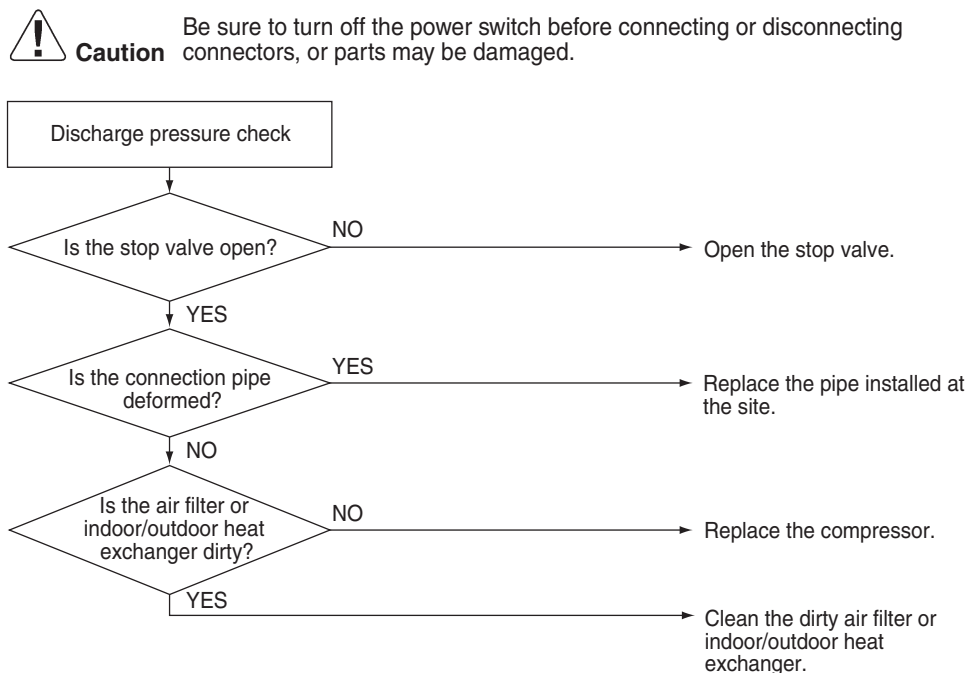

5.9 Outdoor Fan System Check

Check No.19

DC motor



Caution

Be sure to turn off the power switch before connecting or disconnecting connectors, or parts may be damaged.

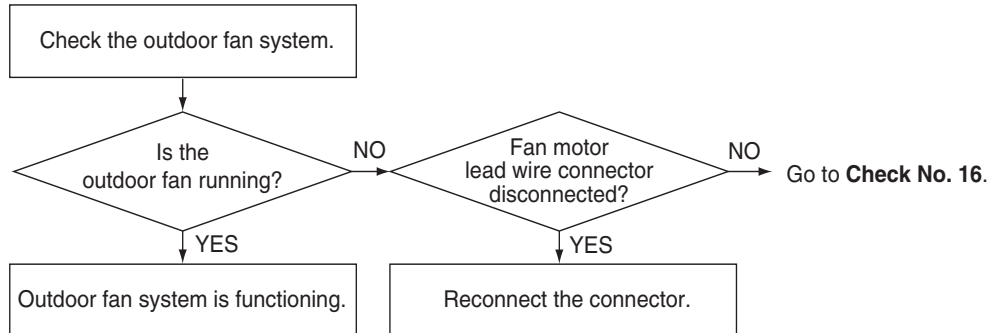

5.10 Main Circuit Short Check

Check No.20

Check to make sure that the voltage between (+) and (-) of the diode bridge (DB1) is approximately 0 V before checking.

- Measure the resistance between the pins of the DB1 referring to the table below.
- If the resistance is ∞ or less than 1 k Ω , short circuit occurs on the main circuit.

Positive terminal (+) of digital multimeter	~ (2, 3)	+ (4)	~ (2, 3)	- (1)
Negative terminal (-) of digital multimeter	+ (4)	~ (2, 3)	- (1)	~ (2, 3)
Resistance is OK.	several k Ω ~ several M Ω			
Resistance is NG.	0 Ω or ∞			

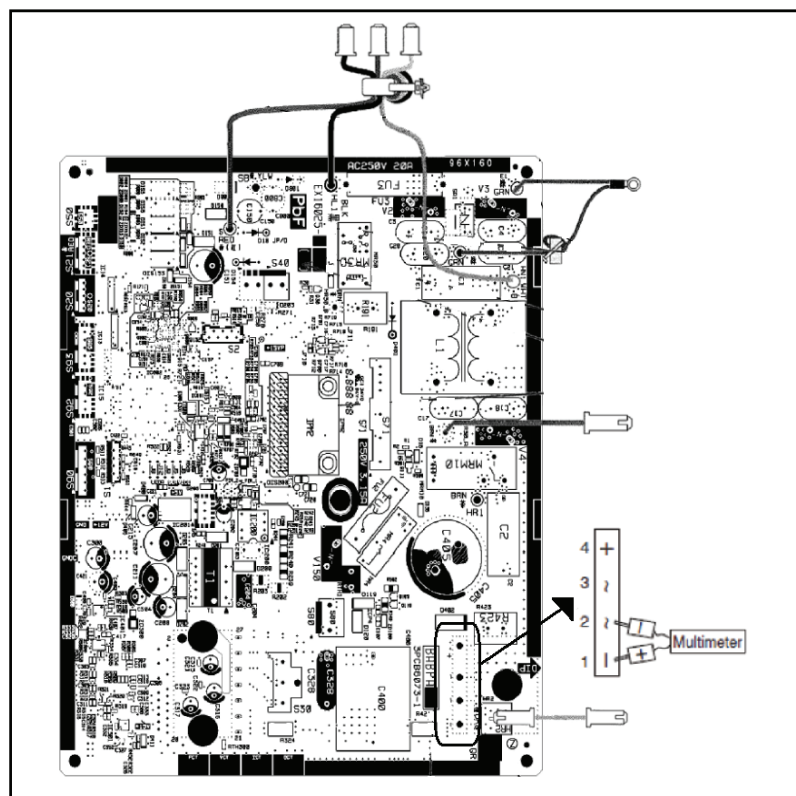

Diagram Main Circuit Short Check for Class 09 and Class 12

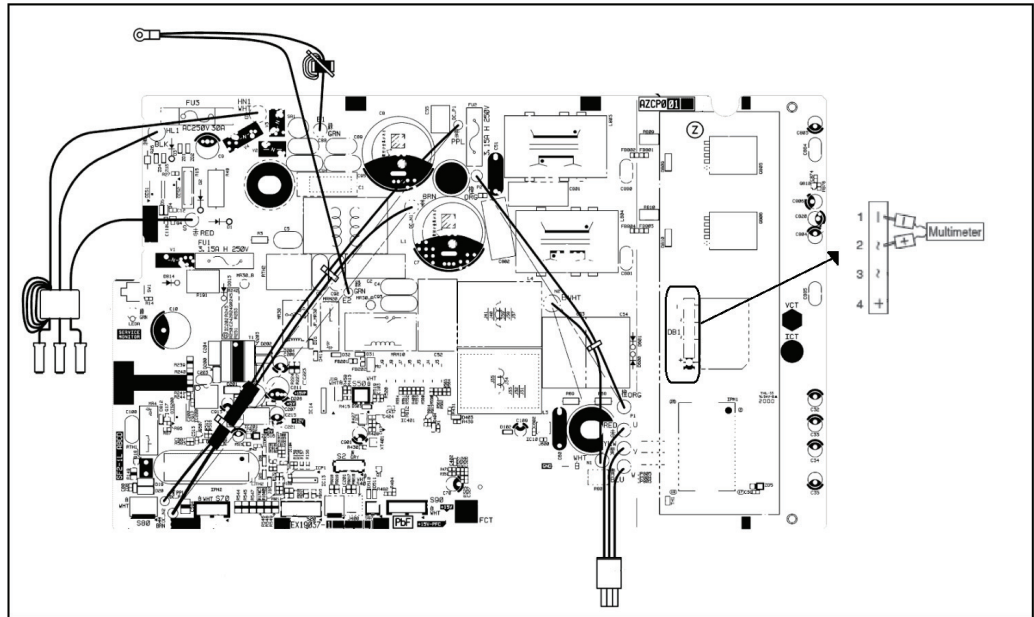

Diagram Main Circuit Short Check for Class 18 and Class 24

5.11 Power Module Check

Check No.22

Check to make sure that the voltage between (+) and (-) of the power module is approximately 0 V before checking.

- Disconnect the compressor harness connector from the outdoor unit PCB. To disengage the connector, press the protrusion on the connector.
- Follow the procedure below to measure resistance between the (+) or (-) terminal of the power module and the U, V, or W terminal of the compressor with a multimeter. Evaluate the measurement results referring to the following table.

Positive terminal (+) of digital multimeter	Power module (+)	UVW	Power module (-)	UVW
Negative terminal (-) of digital multimeter	UVW	Power module (+)	UVW	Power module (-)
Resistance is OK.	several kΩ ~ several MΩ			
Resistance is NG.	0 Ω or ∞			

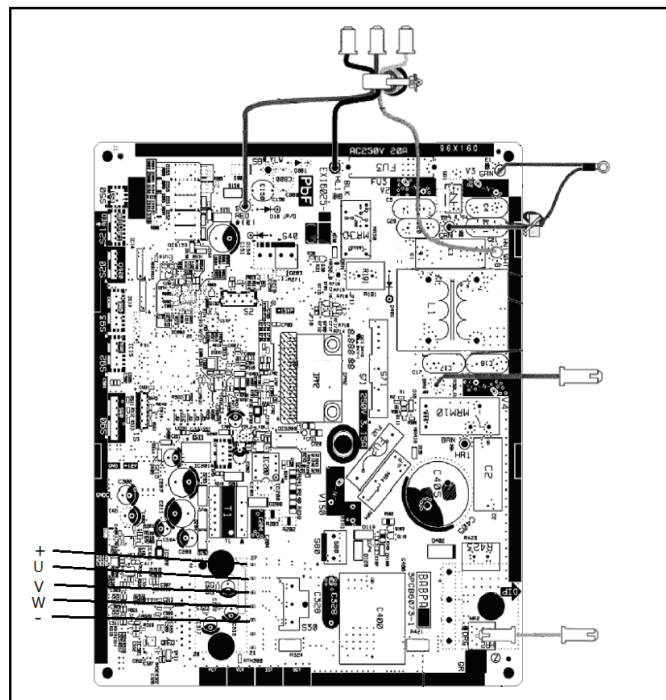

Diagram Power Module Check for Class 09 and Class 12

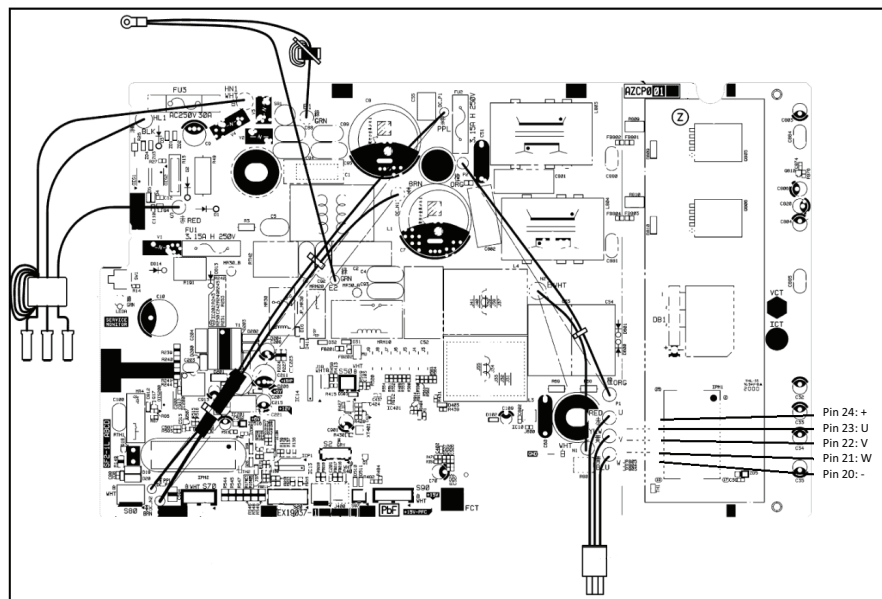

Diagram Power Module Check for Class 18 and Class 24

Part 6

Trial Operation and

Field Settings

1. Pump Down Operation.....	104
2. Forced Cooling Operation.....	105
3. Silicone Grease on Power Transistor/Diode Bridge.....	106

1. Pump Down Operation

Outline

In order to protect the environment, be sure to conduct pump down operation when relocating or disposing of the unit.

Details

1. Remove the valve caps from the liquid stop valve and the gas stop valve.
2. Carry out forced cooling operation.
3. After 5 to 10 minutes, close the liquid stop valve with a hexagonal wrench.
4. After 2 to 3 minutes, close the gas stop valve and stop the forced cooling operation.

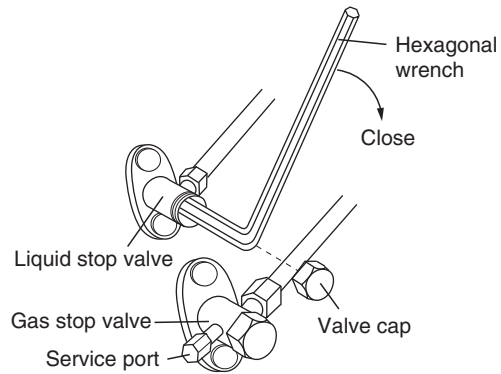

Reference

Refer to page 105 for forced cooling operation.

2. Forced Cooling Operation

Outline

The forced cooling operation is allowed when both the following conditions are met.

1. The outdoor unit is not abnormal and not in the 3-minute standby mode.
2. The outdoor unit is not operating.

Protection functions have priority over all other functions during forced cooling operation.

Details

■ With indoor unit ON/OFF switch

Press indoor unit **ON/OFF** switch (SW1) for at least 5 seconds. The operation will start.

Forced cooling operation will stop automatically after about 15 minutes.

To stop the operation, press indoor unit **ON/OFF** switch.

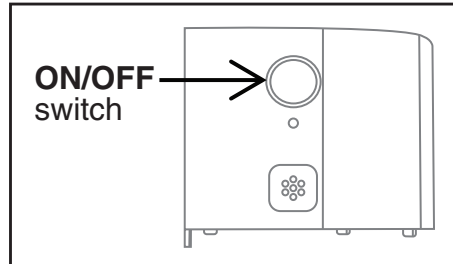

3. Silicone Grease on Power Transistor/Diode Bridge

Outline

Apply the specified silicone grease to the heat radiation part of a power transistor/diode bridge when you replace an outdoor unit PCB. The silicone grease encourages the heat radiation of a power transistor/diode bridge.

Details

1. Wipe off the old silicone grease completely.
2. Apply the silicone grease evenly. See the illustrations below for examples of application.
3. Tighten the screws of the power transistor/diode bridge.
4. Make sure that the heat radiation parts are firmly contacted to the radiation fin.

Note: Smoke emission may be caused by bad heat radiation when the silicone grease is not appropriately applied.

- OK: Evenly applied

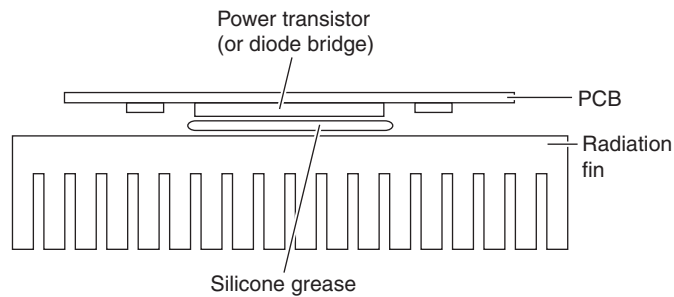

- NG: Not evenly applied

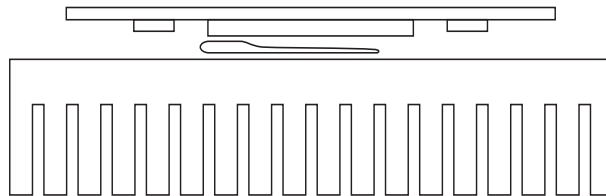

- NG: Foreign matter is stuck.

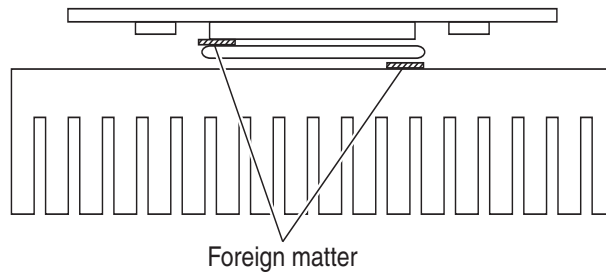

Part 7 Appendix

- 1. Piping Diagrams 108
 - 1.1 Indoor Unit..... 108
 - 1.2 Outdoor Unit..... 110
- 2. Wiring Diagrams..... 112
 - 2.1 Indoor Unit..... 112
 - 2.2 Outdoor Unit..... 113
 - 2.3 Printed Circuit Board Connector Wiring Diagram..... 114
 - 2.4 Printed Circuit Board Connector Wiring Diagram..... 115
- 3. Operation Limit..... 117

1. Piping Diagrams

1.1 Indoor Unit

Model: FTXC09A

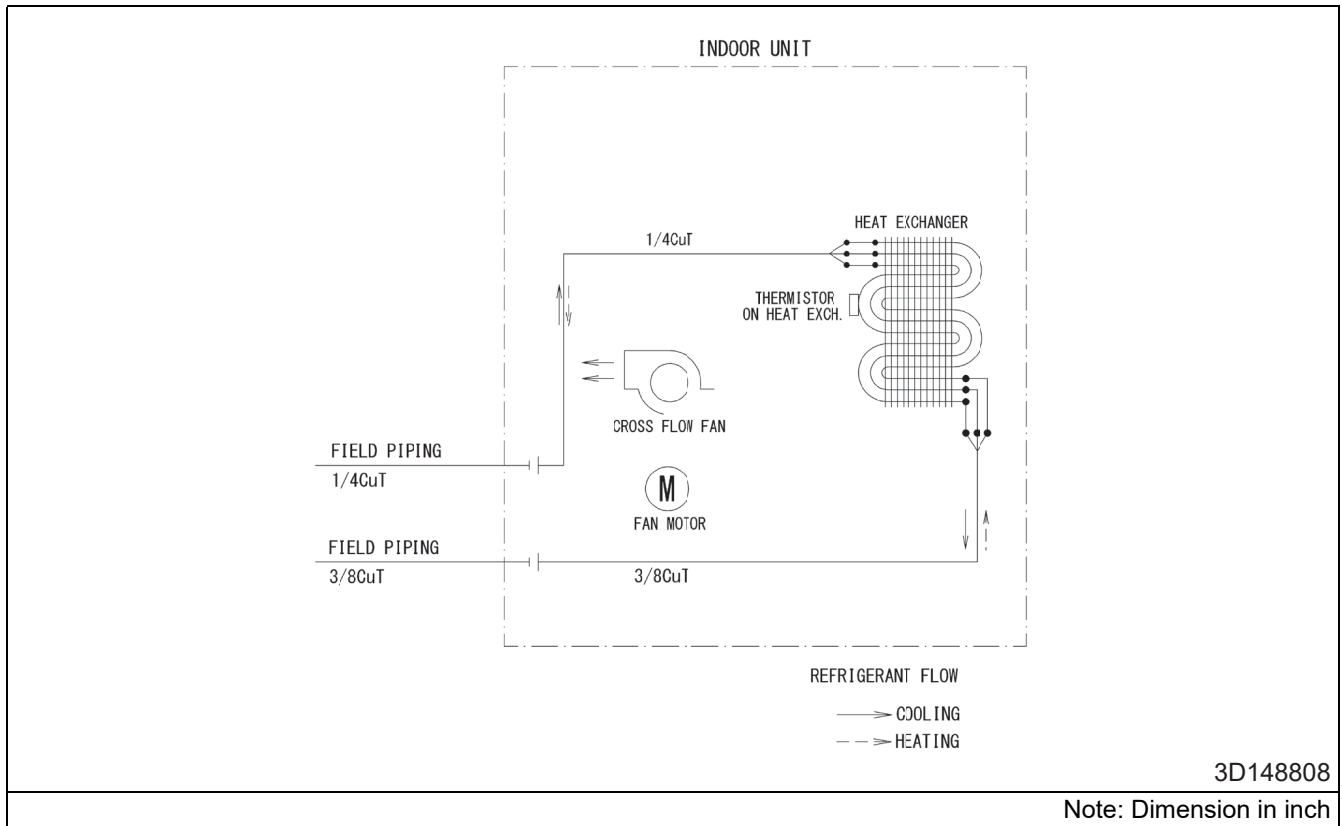

Model: FTXC12A

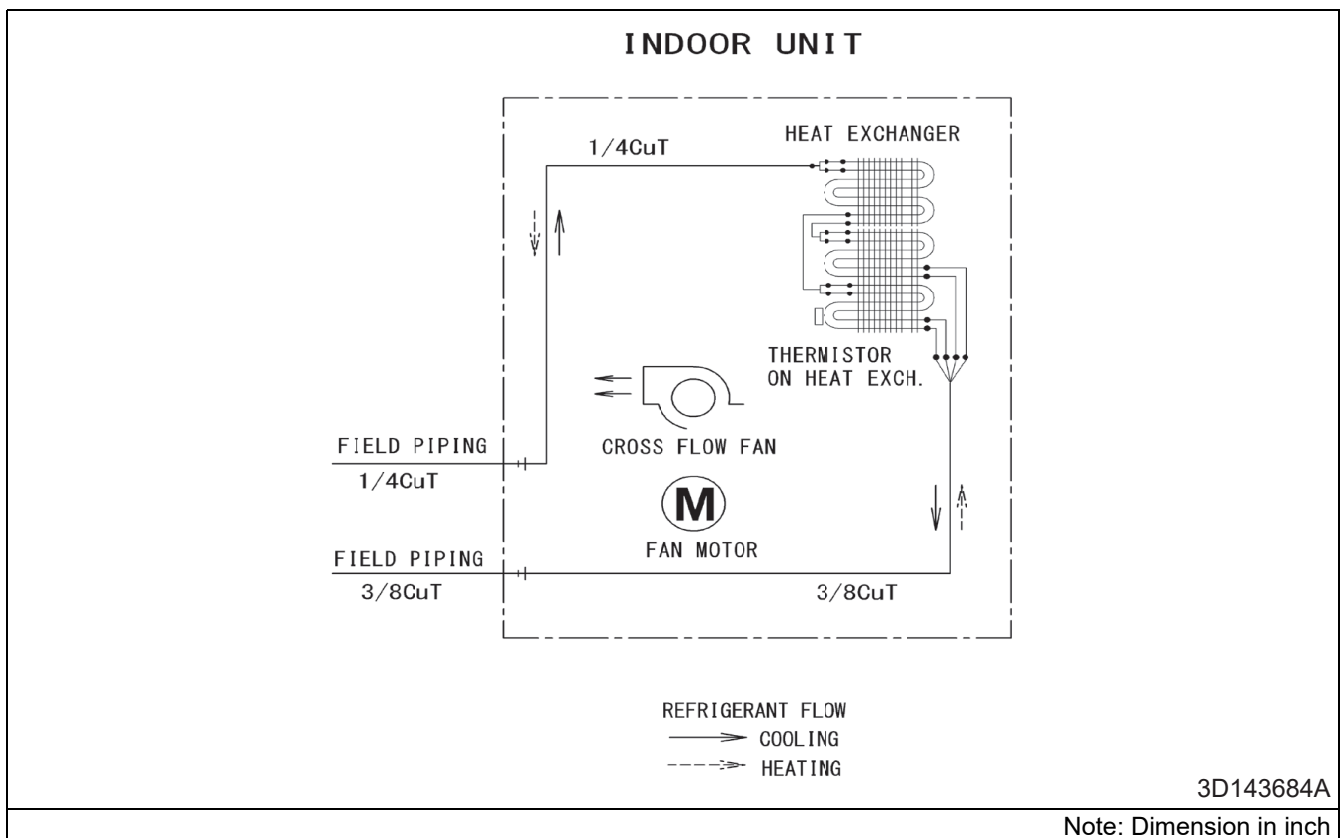

Model: FTXC18A

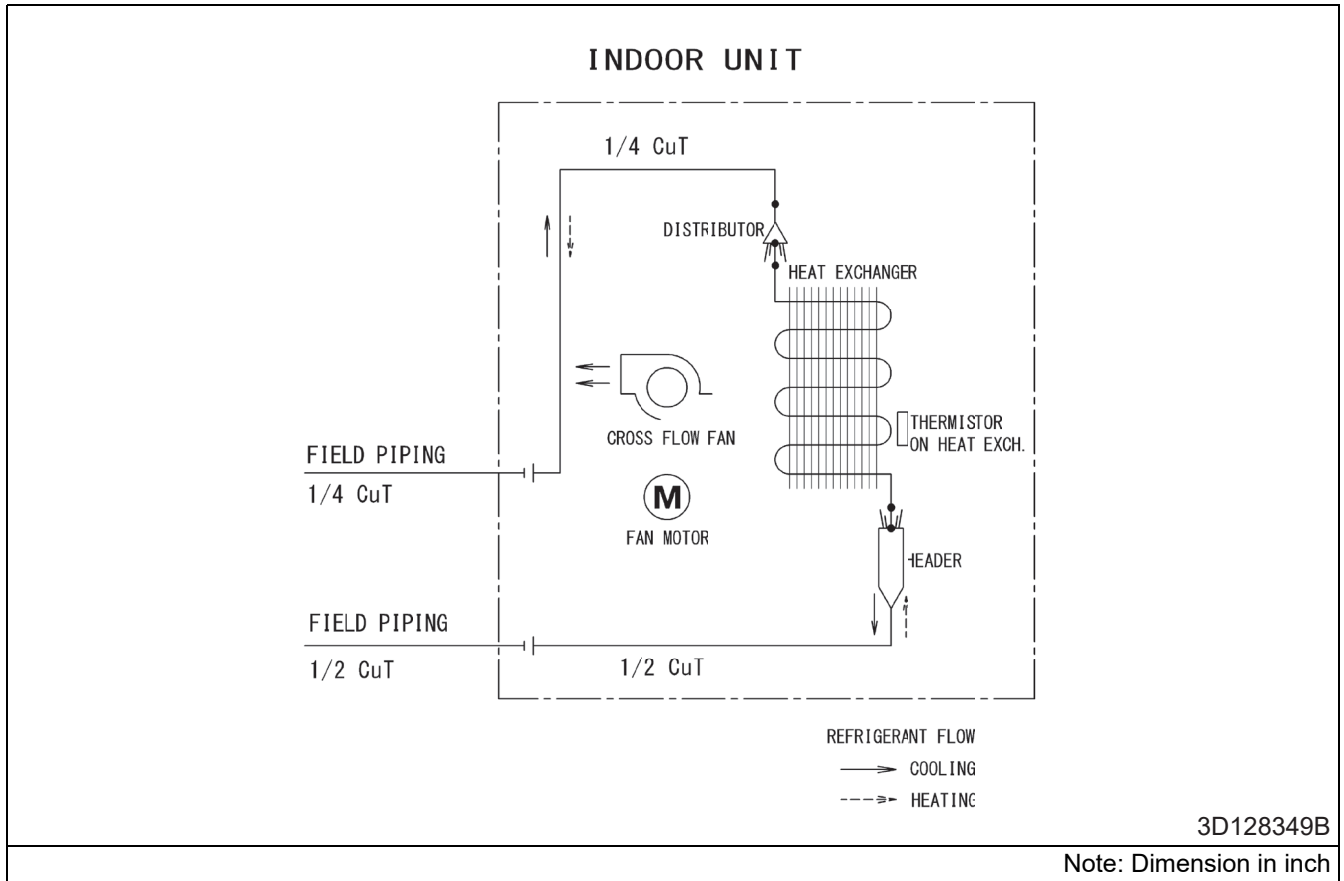

Model: FTXC24A

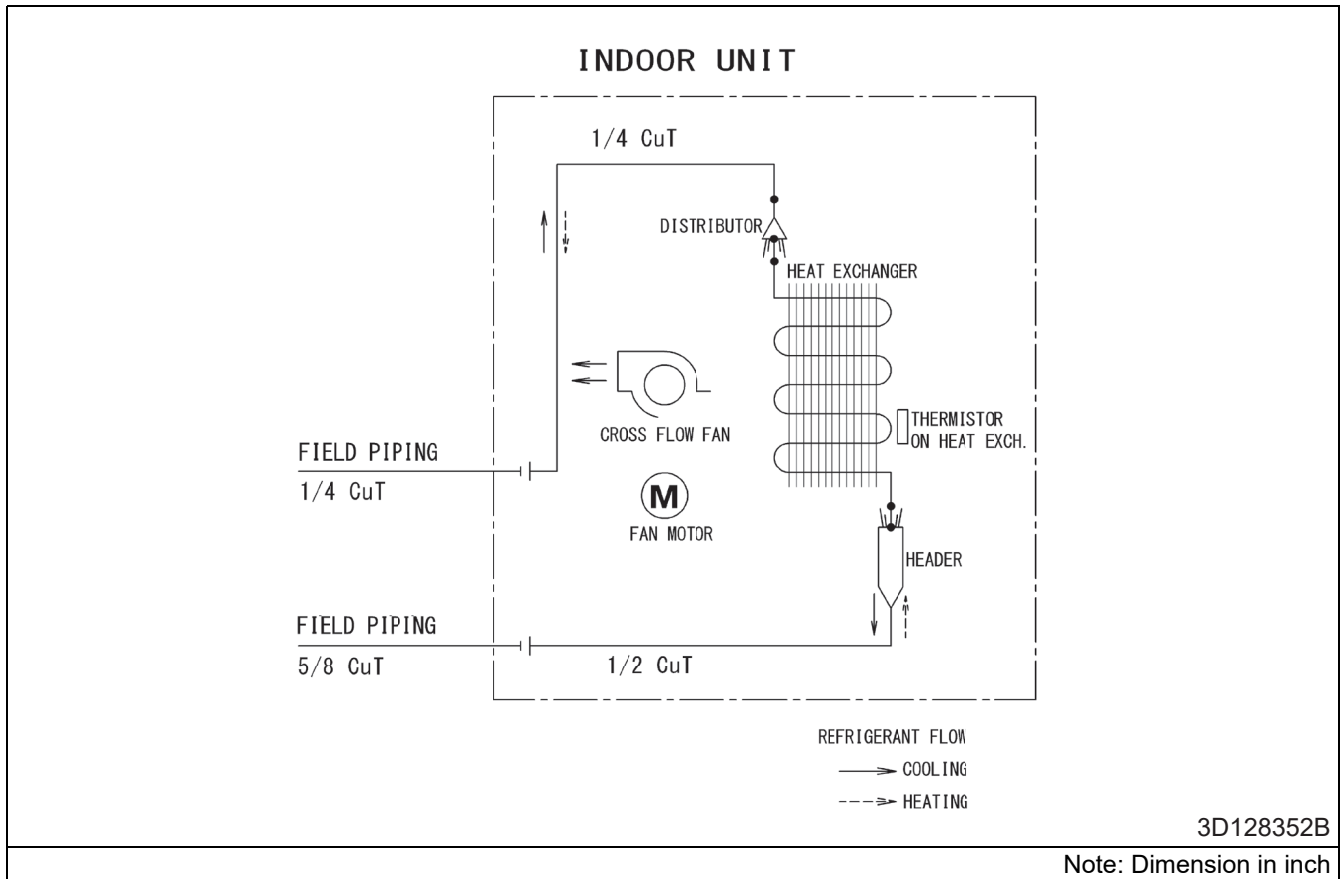

1.2 Outdoor Unit

Model: RXC09/12A

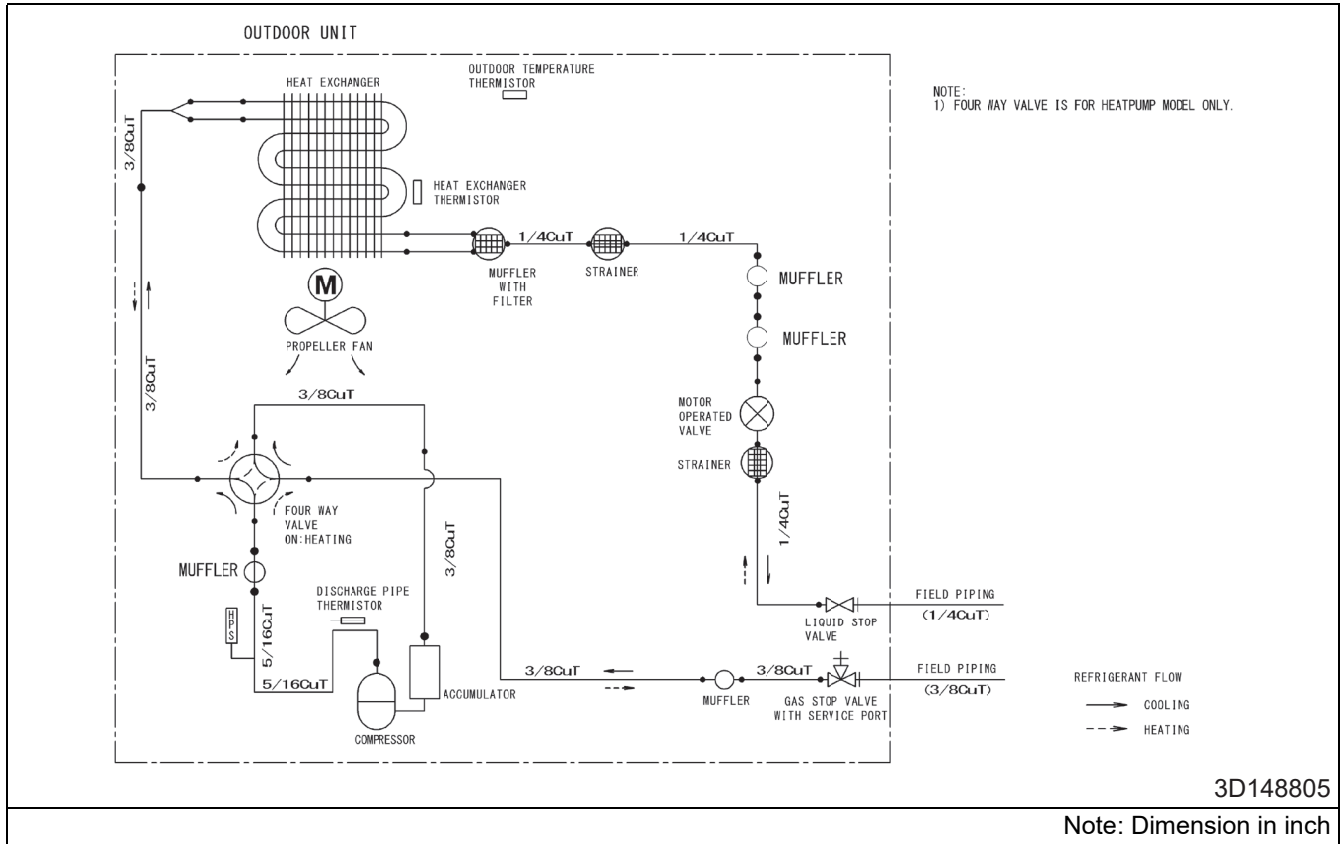

Model: RXC18A

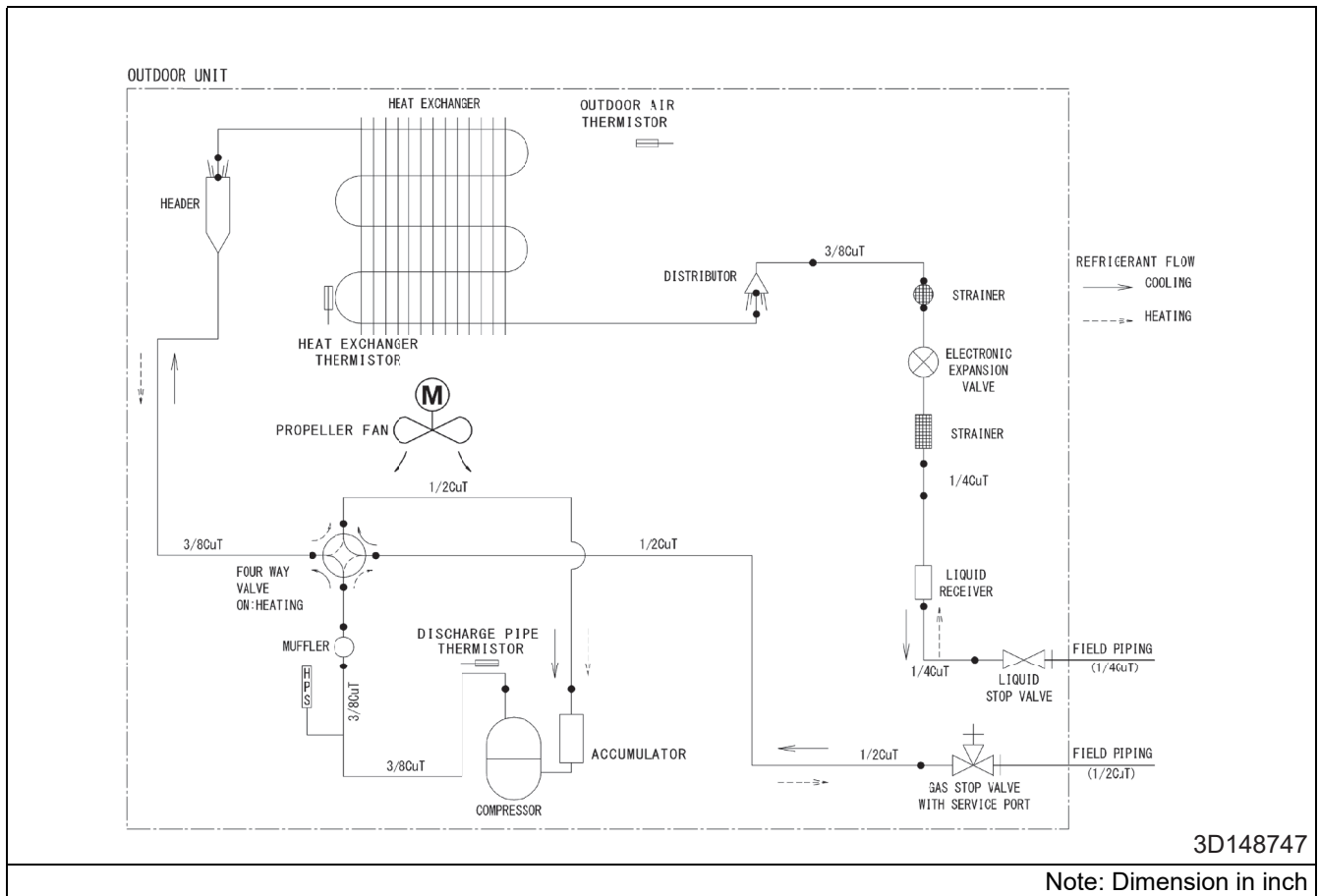

Model: RXC24A

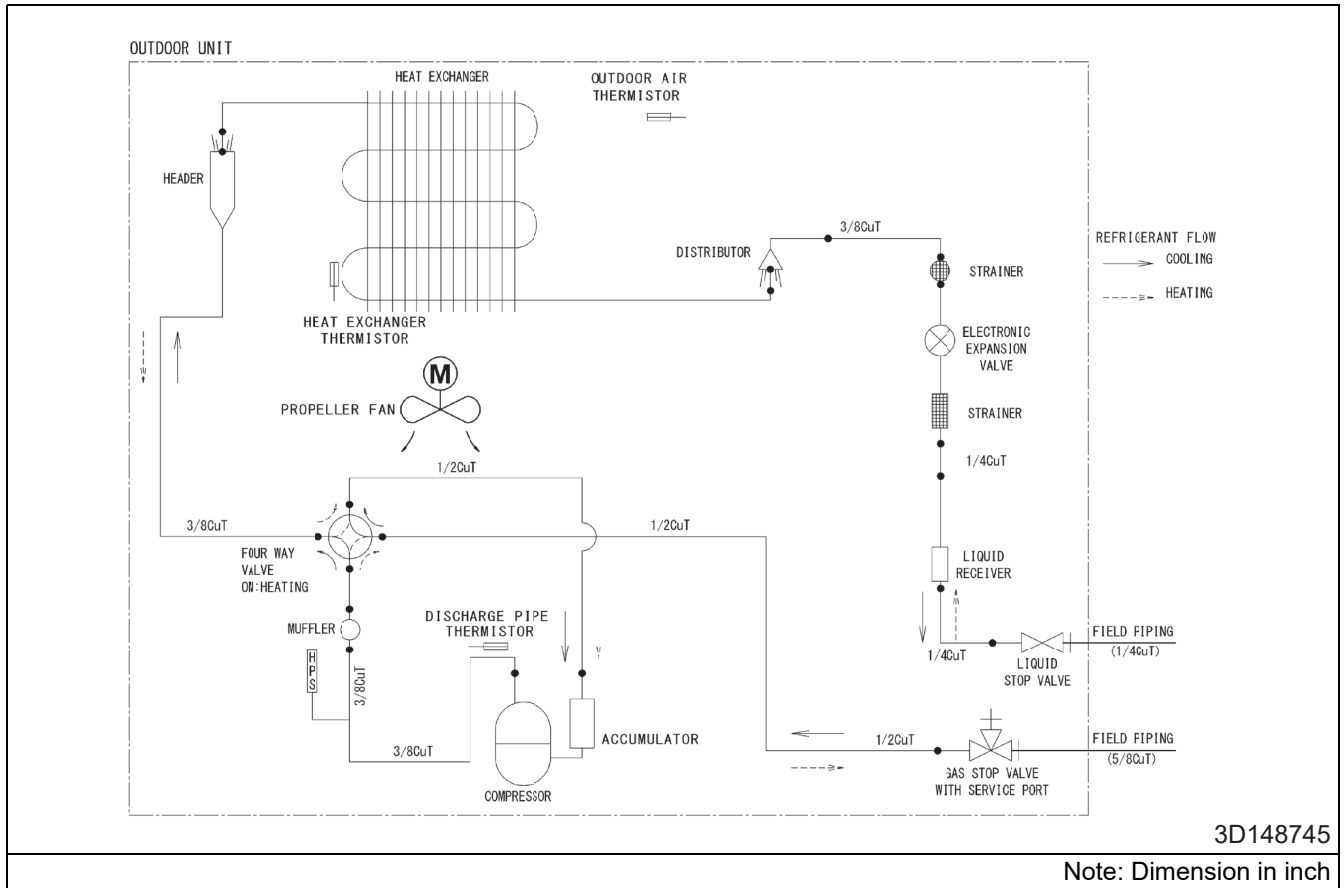

2. Wiring Diagrams

2.1 Indoor Unit

Cooling only

Model: FTXC-A

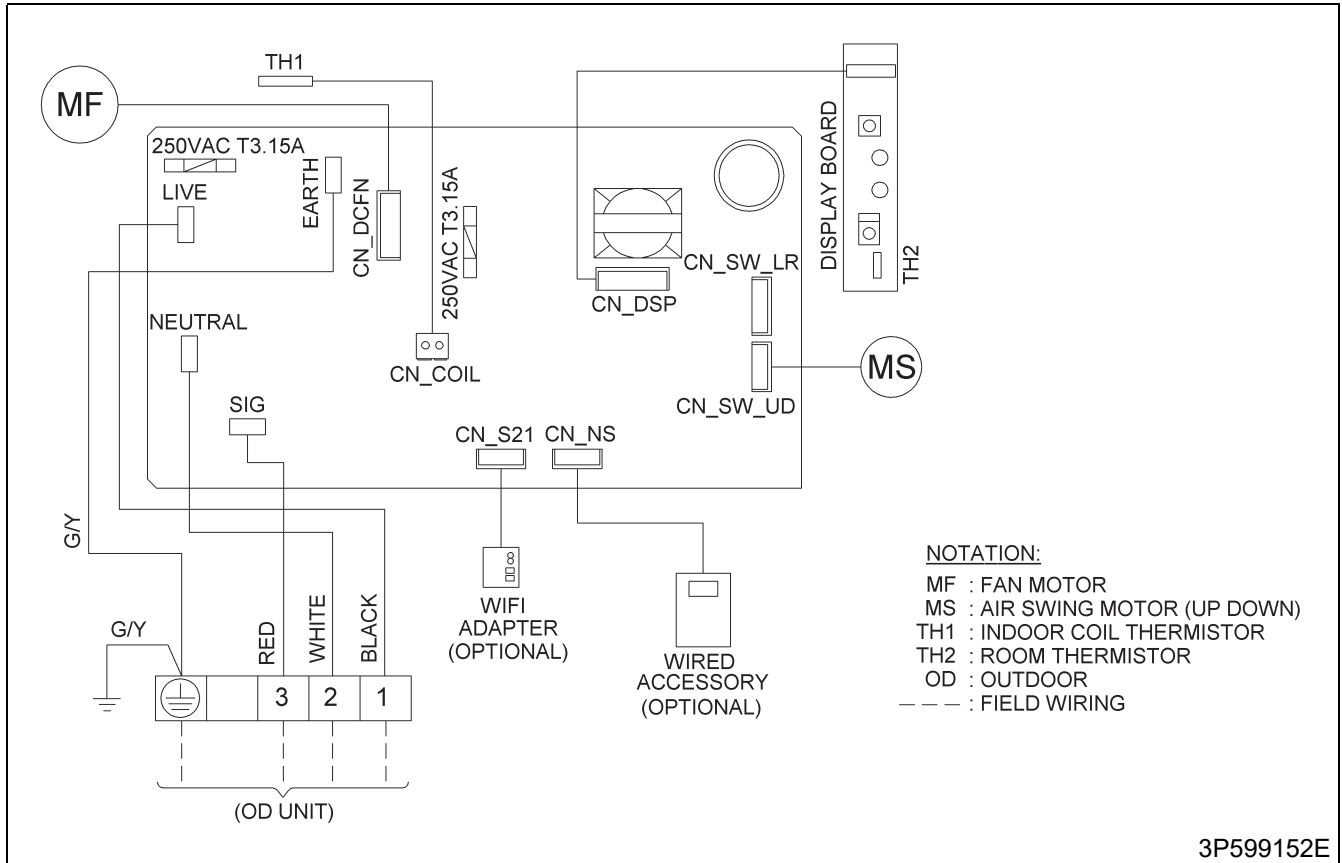

2.2 Outdoor Unit

Model: RXC09/12A

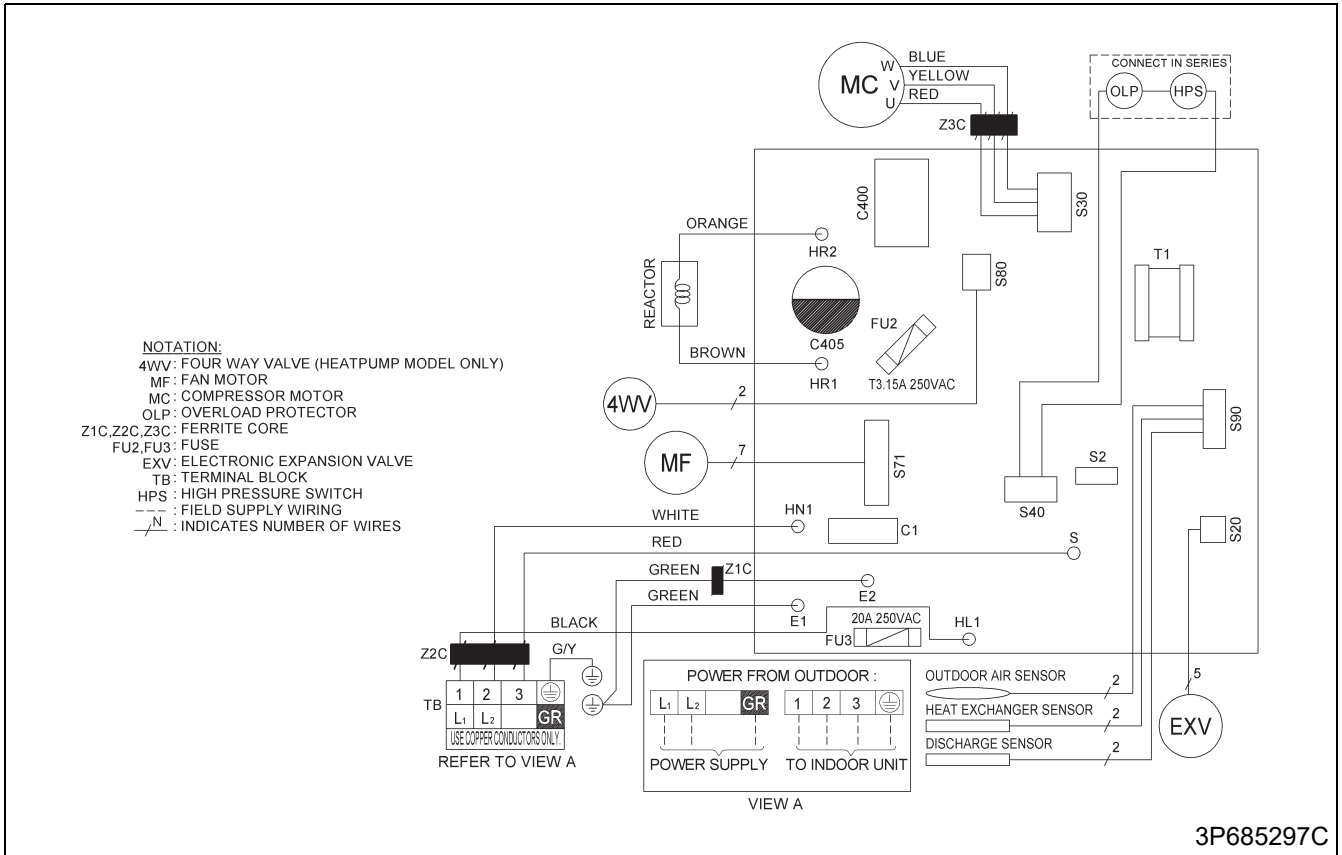

Model: RXC18/24A

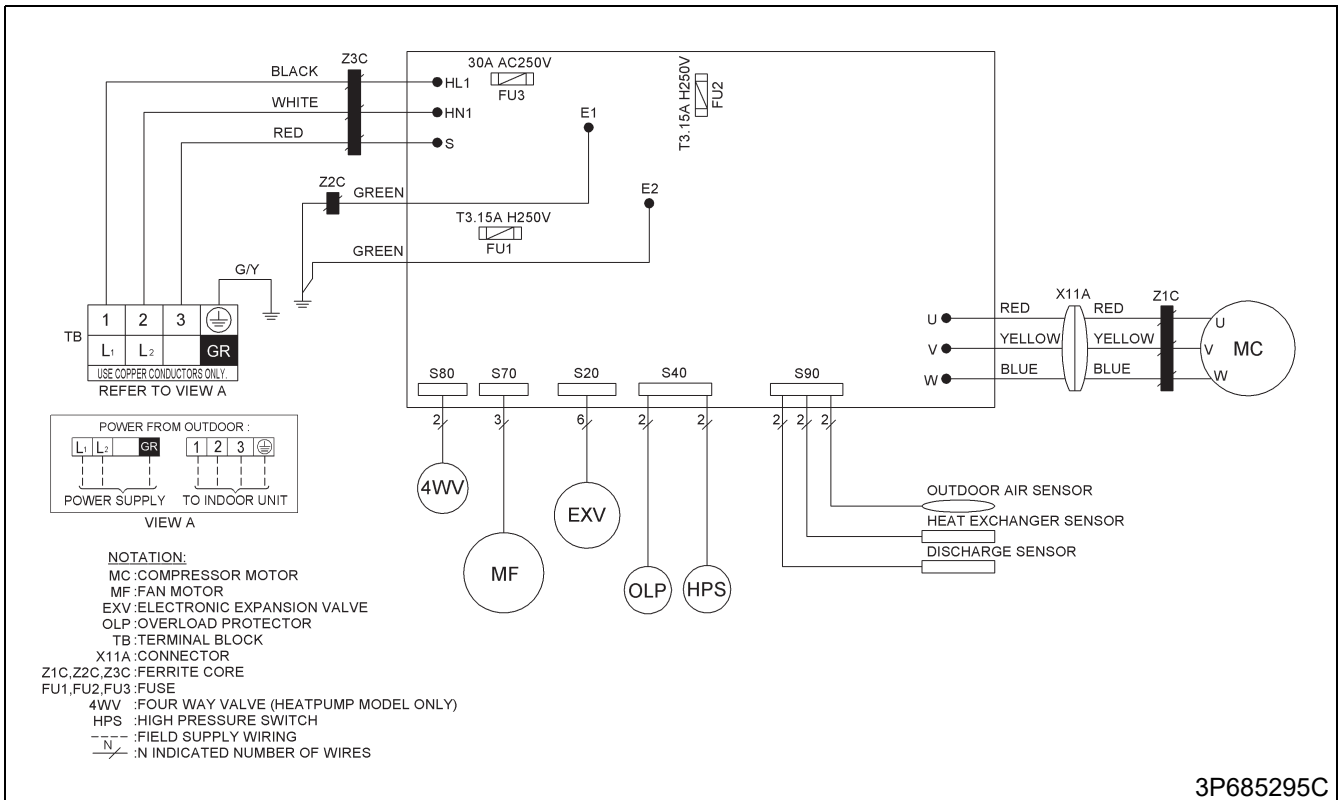

2.3 Printed Circuit Board Connector Wiring Diagram

Control PCB

- 1) CN_SW_UD Connector for swing motor (horizontal blade)
- 2) CN_DSP Connector for display/signal receiver PCB (A2P)
- 3) CN_COIL Connector for indoor heat exchange thermistor (R2T)
- 4) CN_DCFN Connector for DC fan motor
- 5) LIVE, NEUTRAL, SIG Connector for terminal strip
- 6) EARTH Connector for terminal strip (frame ground)
- 7) F101, F111 Fuse (3.15 A, 250 V)
- 8) V101 Varistor

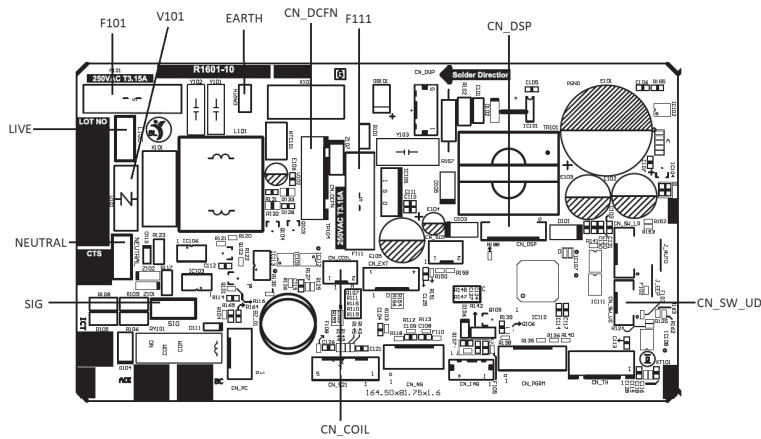

Display/Signal Receiver PCB

- 1) CN_DSP1 Connector for control PCB (A1P)
- 2) SW201 Indoor unit ON/OFF switch
(Forced cooling operation ON/OFF switch)
* Refer to page 105 for detail of forced cooling operating.
- 3) COOL/HEAT LED LED for operating
- 4) TIMER LED LED for timer (yellow)
- 5) RTH201 Room temperature thermistor

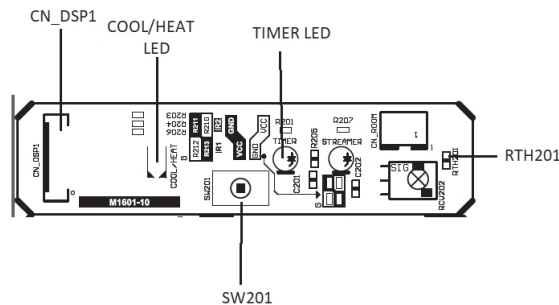

2.4 Printed Circuit Board Connector Wiring Diagram

2.4.1 09/12 Class

Main PCB

- | | | |
|-----|-------------|---|
| 1) | S20 | Connector for electronic expansion valve coil |
| 2) | S40 | Connector for overload protector |
| 3) | S71 | Connector for DC fan motor |
| 4) | S90 | Connector for thermistors
(outdoor temperature, outdoor heat exchanger,
discharge pipe temperature) |
| 5) | HL1, HN1, S | Connector for terminal strip |
| 6) | E1, E2 | Terminals for earth wire |
| 7) | S30 | Connector for compressor |
| 8) | FU2 | Fuse (3.15 A, 250 V) |
| 9) | FU3 | Fuse (20 A, 250 V) |
| 10) | LED A | LED for service monitor (green) |
| 11) | V2, V3 | Varistor |

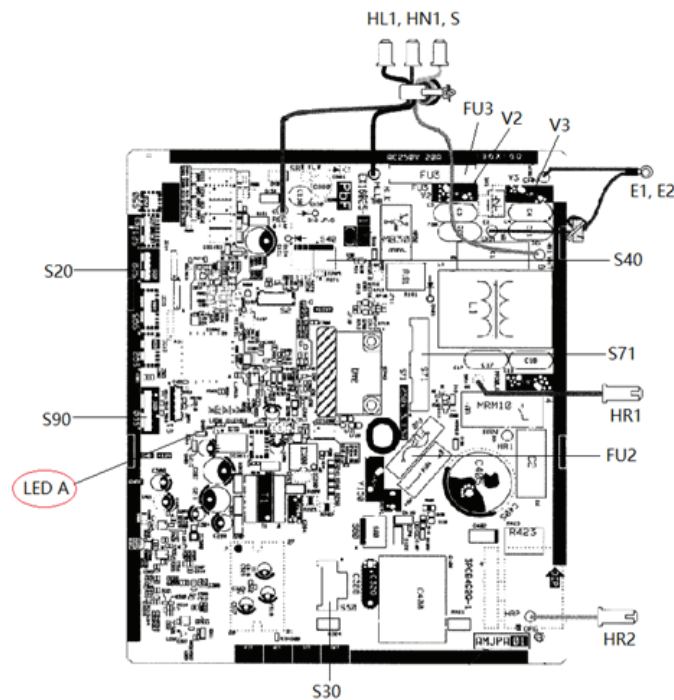

2.4.2 18/24 Class

Main PCB

- | | | |
|-----|-------------|---|
| 1) | S20 | Connector for electronic expansion valve coil |
| 2) | S40 | Connector for overload protector |
| 3) | S70 | Connector for DC fan motor |
| 4) | S90 | Connector for thermistors (outdoor temperature, outdoor heat exchanger, discharge pipe temperature) |
| 5) | S80 | Connector for four way valve coil |
| 6) | HL1, HN1, S | Connector for terminal strip |
| 7) | E1, E2 | Terminals for earth wire |
| 8) | U, V, W | Connector for compressor |
| 9) | FU1, FU2 | Fuse (3.15 A, 250 V) |
| 10) | FU3 | Fuse (30 A, 250 V) |
| 11) | LED A | LED for service monitor (green) |
| 12) | V1, V2, V3 | Varistor |

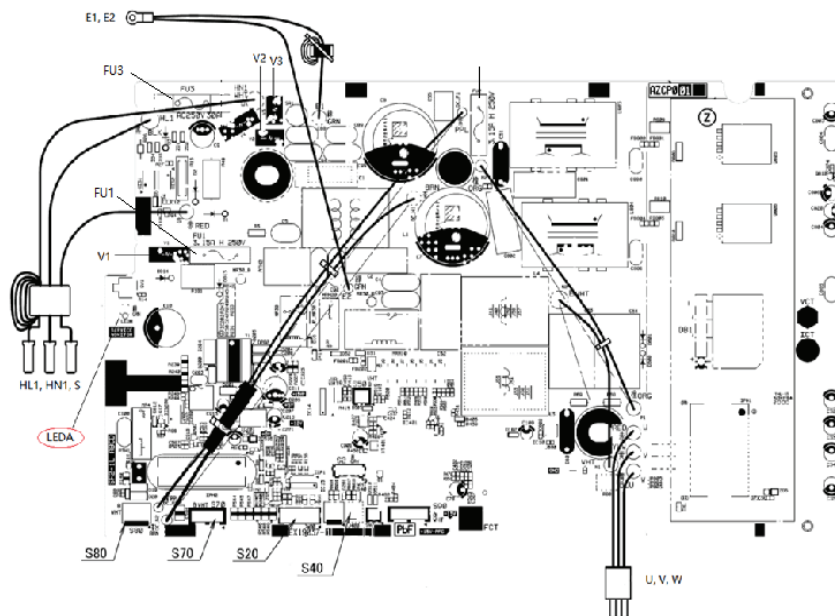

3. Operation Limit

Heatpump

Model: RXB-B

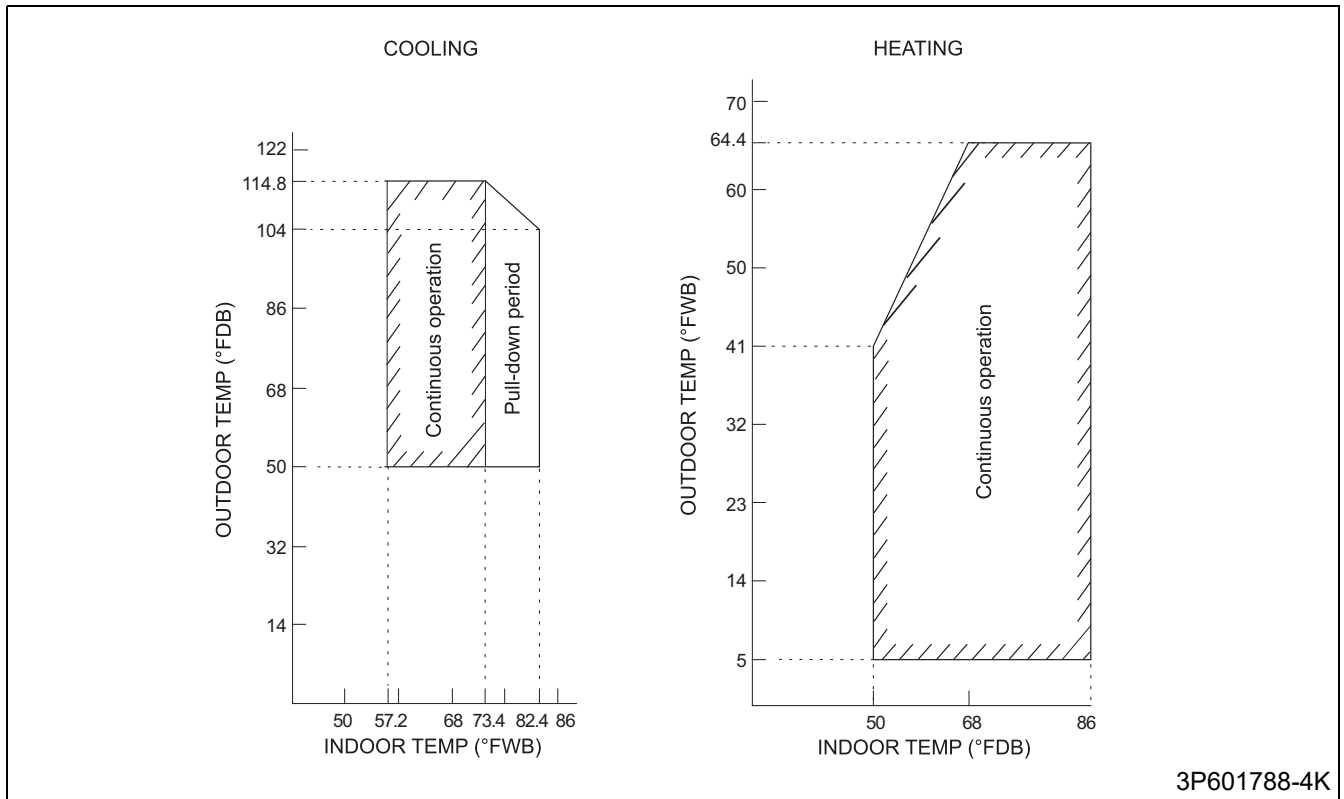

Warning



- Daikin products are manufactured for export to numerous countries throughout the world. Prior to purchase, please confirm with your local authorized importer, distributor and/or retailer whether this product conforms to the applicable standards, and is suitable for use, in the region where the product will be used. This statement does not purport to exclude, restrict or modify the application of any local legislation.
- Ask a qualified installer or contractor to install this product. Do not try to install the product yourself. Improper installation can result in water or refrigerant leakage, electrical shock, fire or explosion.
- Use only those parts and accessories supplied or specified by Daikin. Ask a qualified installer or contractor to install those parts and accessories. Use of unauthorized parts and accessories or improper installation of parts and accessories can result in water or refrigerant leakage, electrical shock, fire or explosion.
- Read the user's manual carefully before using this product. The user's manual provides important safety instructions and warnings. Be sure to follow these instructions and warnings.

If you have any inquiries, please contact your local importer, distributor and/or retailer.

Cautions on product corrosion

1. Air conditioners should not be installed in areas where corrosive gases, such as acid gas or alkaline gas, are produced.
2. If the outdoor unit is to be installed close to the sea shore, direct exposure to the sea breeze should be avoided. If you need to install the outdoor unit close to the sea shore, contact your local distributor.

DAIKIN MALAYSIA SDN. BHD.

Lot 60334, Persiaran Bukit Rahman Putra 3,
Taman Perindustrian Bukit Rahman Putra,
47000 Sungai Buloh, Selangor Darul Ehsan,
Malaysia.

<http://www.daikin.com/products/ac/>

© All rights reserved