



# ENGINEERING DATA

**Inverter Split Unit Air Conditioner  
Wall Mounted  
Heatpump [60Hz]**

**FTXC-A Series**



**R32**

ED3WM2R-NA24V3  
Supersede : ED3WM2R-NA24V2



---

# Table of Contents

<b>Introduction</b> .....	<b>1</b>
Model Name and Power Supply .....	1
Nomenclature .....	2
<b>Functions</b> .....	<b>3</b>
<b>Specifications</b> .....	<b>4</b>
<b>Dimensions</b> .....	<b>8</b>
<b>Wiring Diagrams</b> .....	<b>10</b>
<b>Piping Diagrams</b> .....	<b>12</b>
<b>Capacity Tables</b> .....	<b>16</b>
Capacity Tables .....	16
Capacity Correction Factor .....	20
<b>Operation Limit</b> .....	<b>22</b>
<b>Sound Level</b> .....	<b>23</b>
Measuring Location .....	23
Sound Pressure Level & NC Curve .....	24
<b>Electric Characteristic</b> .....	<b>32</b>
<b>Accessories List</b> .....	<b>33</b>



# Introduction

## Model Name and Power Supply

Indoor Unit	Outdoor Unit	Power Supply
FTXC09AXVJU	RXC09AXVJU	1Phase, 208/230V, 60Hz
FTXC12AXVJU	RXC12AXVJU	
FTXC18AXVJU	RXC18AXVJU	
FTXC24AXVJU	RXC24AXVJU	

## Nomenclature

### Indoor Unit

Definition	Description
Unit Category	<b>F</b> : Air-Cooled Split Indoor Unit
Product Type	<b>T</b> : Wall Mounted
System	<b>X</b> : Inverter, Heatpump
Classification	<b>C</b> : R32, Standard
Capacity Indication*	<b>09</b> : 9,000 Btu/h
Major Design Category	<b>A</b> : A Series
Factory Origin	<b>X</b> : Malaysia
Power Supply	<b>VJ</b> : 208/230V / 1Phase / 60Hz
Country	<b>U</b> : United States

### Outdoor Unit

Definition	Description
Unit Category	<b>R</b> : Air-Cooled Split Outdoor Unit
System	<b>X</b> : Inverter, Heatpump
Classification	<b>C</b> : R32, Standard
Capacity Indication*	<b>09</b> : 9,000 Btu/h
Major Design Category	<b>A</b> : A Series
Factory Origin	<b>X</b> : Malaysia
Power Supply	<b>VJ</b> : 208/230V / 1Phase / 60Hz
Country	<b>U</b> : United States

**Remark:**

\*Capacity value under Nomenclature is an indication.  
Please refer to Specifications for exact capacity value.

# Functions

Category	Functions	FTXC09/12A RXC09/12A	FTXC18/24A RXC18/24A
Basic Function	Inverter		●
	Operation Limit for Cooling (°CDB)(O/D)		10 ~ 46
	Operation Limit for Cooling (°FDB)(O/D)		50 ~ 114.8
	Operation Limit for Heating (°CWB)(O/D)		-15 ~ 18
	Operation Limit for Heating (°FWB)(O/D)		5 ~ 64.4
Compressor	Scroll Compressor		-
	Rotary Compressor		-
	Swing Compressor		●
Comfortable Airflow	Power-airflow Flap	●	-
	Power-airflow Dual Flaps	-	●
	Power-airflow Diffuser		-
	Wide Angle Louvers		●
	Vertical Auto-Swing (Up and Down)		●
	Horizontal Auto-Swing (Right and Left)		-
	3D Airflow		-
	Breeze Airflow		-
Comfort Control	Auto Fan Speed		●
	Indoor Unit Quiet Operation		●
	Intelligent Eye Operation		-
	Automatic Defrosting		●
Operation	Automatic Operation		●
	Programme Dry Function		●
	Fan Only		●
Lifestyle Convenience	Powerful Operation (Non Inverter)		-
	Inverter Powerful Operation		●
	Energy Saving Function		●
	Sleep Mode		●
	Indoor Unit ON/OFF Button		●
	R/C with Backlight		●
	Signal Receiving Sign (R/C)		●
Set Temperature Display (R/C)		●	
Health & Clean	Saranet Filter		-
	GIN-ION Filter		-
	Catechin Filter / Green Tea Filter		●
	Titanium Apatite Air-Purifying Filter		●
	Enzyme Blue Deodorizing Filter		-
	PM 2.5 Filter		-
	Streamer		-
	Plasma		-
	Wipe Clean Flat Panel		●
	Coil Clean (by APP control)		-
Timer	Weekly Timer Operation (Wired R/C)		-
	24-hour ON/OFF Timer (R/C)		●
	Countdown ON/OFF Timer (R/C)		-
	Auto Restart (after Power Failure)		●
Worry Free (Reliability & Durability)	Self-diagnosis		●
	Anti-corrosion Treatment of Outdoor Heat Exchanger		Blue Fin
	Low/High Voltage Shield (PCB Level / Unit Level)		-
	Pre-charged Piping Length		32-13/16 ft
Flexibility	Either Side Drain (Right or Left)		●
	Detachable Drain Pan		●
	Low ambient cooling operation (-15°C) (5°F)		-
	Wireless LAN Connectivity		●*
Remote Control	BAG Connectivity		●*
	iTM Connectivity		-
	DIII-NET Connectivity		-
	Remote Controller	Wireless	
Wired (Optional)			BRC51D61

Note: ● : Available

- : Not Available

●\* : Optional (Refer to DAMA Spare Part team for more details on optional items.)

# Specifications

MODEL	INDOOR UNIT		FTXC09A	
	OUTDOOR UNIT		RXC09A	
		Cooling	Heating	
Rated Capacity (Min. ~ Max.)	kW	2.64 (1.30 - 3.00)	2.75 (1.30 - 3.80)	
	Btu/h	9000 (4400 - 10200)	9400 (4400 - 13000)	
Moisture Removal	gal/h	0.05		
Rated Running Current	A	3.56	3.33	
Rated Power Consumption	W	818	765	
EER2	Btu/h/W	11.00	N/A	
SEER2		18.00	N/A	
COP	W/W	N/A	3.60	
HSPF2		N/A	9.00	
Power Factor (Rated)	N/A			
Piping Connections	Liquid	inch (mm)	1/4" (6.35)	
	Gas	inch (mm)	3/8" (9.52)	
Refrigerant	Type	R32		
	Charge	lbs (kg)	1.65 (0.75)	
Max. Interunit Piping Length	ft (m)	65-5/8 (20)		
Max. Interunit Height Difference	ft (m)	32-13/16 (10)		
Chargeless	ft (m)	32-13/16 (10)		
Amount of Additional Charge of Refrigerant	oz/ft (g/m)	0.18 (17)		
Drawing No.	3D148846			
INDOOR UNIT		FTXC09A		
Front Panel Colour	WHITE			
Airflow Rate	Turbo	CFM	466	
	High	CFM	431	402
	Medium	CFM	322	
	Low	CFM	249	
	Quiet	CFM	142	219
Sound Pressure Level (H/M/L/Q)		dB(A)	43/36/29/19	42/35/29/25
Fan	Type	CROSS FLOW		
	Drive	DIRECT		
	Speed	3 STEPS, AUTO, QUIET, TURBO		
Fan Motor	Type	DIRECT CURRENT		
	Motor Output	W	22	
	Running Current (Rated)	A	0.10	
	Power Consumption (Rated)	W	29	
Air Direction Control	UP, DOWN, LEFT, RIGHT			
Air Filter	CATECHIN			
Dimensions (H x W x D)	inch (mm)	11-1/3 x 30-5/16 x 9-11/16 (288 x 770 x 246)		
Packaged Dimensions (H x W x D)	inch (mm)	12-3/8 x 32-11/16 x 14-1/16 (314 x 830 x 357)		
Weight	lbs (kg)	19.8 (9.0)		
Gross Weight	lbs (kg)	24.3 (11.0)		
Condensate Drain Size	inch (mm)	5/8 (16)		
Document No.	3D148845			
OUTDOOR UNIT		RXC09A		
Casing Colour	IVORY WHITE			
Airflow Rate	High	CFM	1051	966
Sound Pressure Level		dB(A)	46	48
Fan	Type	PROPELLER		
	Drive	DIRECT		
Fan Motor	Type	DIRECT CURRENT		
	Index of protection (IP)	24		
	Insulation Grade	E		
	Running Current (Rated)	A	0.61	
	Power Consumption (Rated)	W	46	
	Motor Output	W	26	
Compressor	Poles	8		
	Type	HERMETIC SWING		
	Model	1Y091BKCX1A#G		
	Oil type	DAPHNE FW68DA		
	Oil amount	oz (cm³)	12.7 (375)	
Heat Exchanger Type	FIN TUBE			
Dimensions (H x W x D)	inch (mm)	21-11/16 x 26-1/2 x 11-3/16 (550 x 675 x 284)		
Packaged Dimensions (H x W x D)	inch (mm)	24-1/64 x 31-3/8 x 15-1/8 (610 x 801 x 384)		
Weight	lbs (kg)	60 (27)		
Gross Weight	lbs (kg)	66 (30)		
Document No.	3D148691			

1) ALL UNITS ARE BEING TESTED ACCORDING TO AHRI 210/240 STANDARD.  
 2) ALL SPECIFICATIONS ARE SUBJECT TO CHANGE BY THE MANUFACTURER WITHOUT PRIOR NOTICE.

COOLING		HEATING	
INDOOR: 80°FDB (26.7°CDB) / 67°FWB (19.4°CWB)		INDOOR: 70°FDB (21.1°CDB)	
OUTDOOR: 95°FDB (35°CDB)		OUTDOOR: 47°FDB (8.3°CDB) / 43°FWB(6.1°CWB)	



MODEL	INDOOR UNIT		FTXC12A	
	OUTDOOR UNIT		RXC12A	
			Cooling	Heating
Rated Capacity (Min. ~ Max.)		kW	3.52 (1.30 - 3.90)	3.31 (1.30 - 4.81)
		Btu/h	12000 (4400 - 13300)	11300 (4400 - 16400)
Moisture Removal		gal/h	0.16	
Rated Running Current		A	6.14	4.36
Rated Power Consumption		W	1412	1004
EER2		Btu/h/W	8.50	N/A
SEER2			18.00	N/A
COP		W/W	N/A	3.30
HSPF2			N/A	9.00
Power Factor (Rated)			N/A	
Piping Connections	Liquid	inch (mm)	1/4" (6.35)	
	Gas	inch (mm)	3/8" (9.52)	
Refrigerant	Type		R32	
	Charge	lbs (kg)	1.65 (0.75)	
Max. Interunit Piping Length		ft (m)	65-5/8 (20)	
Max. Interunit Height Difference		ft (m)	32-13/16 (10)	
Chargeless		ft (m)	32-13/16 (10)	
Amount of Additional Charge of Refrigerant		oz/ft (g/m)	0.18 (17)	
Drawing No.			3D148846	
INDOOR UNIT		FTXC12A		
Front Panel Colour		WHITE		
Airflow Rate	Turbo	CFM	473	
	High	CFM	436	412
	Medium	CFM	316	
	Low	CFM	247	
	Quiet	CFM	132	210
Sound Pressure Level (H/M/L/Q)		dBA	45/37/31/19	43/36/30/26
Fan	Type	CROSS FLOW		
	Drive	DIRECT		
	Speed	3 STEPS, AUTO, QUIET, TURBO		
Fan Motor	Type	DIRECT CURRENT		
	Motor Output	W	22	
	Running Current (Rated)	A	0.10	
	Power Consumption (Rated)	W	29	
Air Direction Control		UP, DOWN, LEFT, RIGHT		
Air Filter		CATECHIN		
Dimensions (H x W x D)		inch (mm)	11-1/3 x 30-5/16 x 9-11/16 (288 x 770 x 246)	
Packaged Dimensions (H x W x D)		inch (mm)	12-3/8 x 32-11/16 x 14-1/16 (314 x 830 x 357)	
Weight		lbs (kg)	20.9 (9.5)	
Gross Weight		lbs (kg)	25.4 (11.5)	
Condensate Drain Size		inch (mm)	5/8 (16)	
Document No.			3D148845	
OUTDOOR UNIT		RXC12A		
Casing Colour		IVORY WHITE		
Airflow Rate	High	CFM	1051	966
Sound Pressure Level		dBA	48	
Fan	Type	PROPELLER		
	Drive	DIRECT		
Fan Motor	Type	DIRECT CURRENT		
	Index of protection (IP)	24		
	Insulation Grade	E		
	Running Current (Rated)	A	0.61	
	Power Consumption (Rated)	W	46	
	Motor Output	W	26	
Compressor	Poles	8		
	Type	HERMETIC SWING		
	Model	1Y091BKCX1A#G		
	Oil type	DAPHNE FW68DA		
	Oil amount	oz (cm <sup>3</sup> )	12.7 (375)	
Heat Exchanger Type		FIN TUBE		
Dimensions (H x W x D)		inch (mm)	21-11/16 x 26-1/2 x 11-3/16 (550 x 675 x 284)	
Packaged Dimensions (H x W x D)		inch (mm)	24-1/64 x 31-3/8 x 15-1/8 (610 x 801 x 384)	
Weight		lbs (kg)	60 (27)	
Gross Weight		lbs (kg)	66 (30)	
Document No.			3D148691	

1) ALL UNITS ARE BEING TESTED ACCORDING TO AHRI 210/240 STANDARD.  
 2) ALL SPECIFICATIONS ARE SUBJECTED TO CHANGE BY THE MANUFACTURER WITHOUT PRIOR NOTICE.

COOLING		HEATING	
INDOOR: 80°FDB (26.7°CDB) / 67°FWB (19.4°CWB)		INDOOR: 70°FDB (21.1°CDB)	
OUTDOOR: 95°FDB (35°CDB)		OUTDOOR: 47°FDB (8.3°CDB) / 43°FWB (6.1°CWB)	

Specifications

MODEL	INDOOR UNIT		FTXC18A	
	OUTDOOR UNIT		RXC18A	
			Cooling	Heating
Rated Capacity (Min. ~ Max.)	kW		5.30 (2.02 - 5.86)	5.28 (1.70 - 6.60)
	Btu/h		18100 (6900 - 20000)	18000 (5800 - 22500)
Moisture Removal	gal/h		0.61	
Rated Running Current	A		7.49	6.95
Rated Power Consumption	W		1724	1599
EER2	Btu/h/W		10.50	N/A
SEER2			18.00	N/A
COP	W/W		N/A	3.30
HSPF2			N/A	9.00
Power Factor (Rated)			N/A	
Piping Connections	Liquid	inch (mm)	1/4" (6.35)	
	Gas	inch (mm)	1/2" (12.70)	
Refrigerant	Type		R32	
	Charge	lbs (kg)	3.31 (1.50)	
Max. Interunit Piping Length	ft (m)		98-1/2 (30)	
Max. Interunit Height Difference	ft (m)		32-13/16 (10)	
Chargeless	ft (m)		32-13/16 (10)	
Amount of Additional Charge of Refrigerant	oz/ft (g/m)		0.18 (17)	
Drawing No.			3D148846	
INDOOR UNIT		FTXC18A		
Front Panel Colour			WHITE	
Airflow Rate	Turbo	CFM	754	
	High	CFM	716	
	Medium	CFM	605	
	Low	CFM	467	
	Quiet	CFM	395	
Sound Pressure Level (H/M/L/Q)	dBA		48/43/37/33	46/41/36/33
Fan	Type		CROSS FLOW	
	Drive		DIRECT	
	Speed		3 STEPS, AUTO, QUIET, TURBO	
Fan Motor	Type		DIRECT CURRENT	
	Motor Output	W	39	
	Running Current (Rated)	A	0.17	
	Power Consumption (Rated)	W	54	
Air Direction Control			UP, DOWN, LEFT, RIGHT	
Air Filter			CATECHIN	
Dimensions (H x W x D)	inch (mm)		11-11/16 x 39-9/16 x 11-1/3 (297 x 990 x 288)	
Packaged Dimensions (H x W x D)	inch (mm)		14-3/4 x 14-5/8 x 42-1/4 (375 x 371 x 1073)	
Weight	lbs (kg)		30.5 (13.8)	
Gross Weight	lbs (kg)		36 (16.5)	
Condensate Drain Size	inch (mm)		5/8 (16)	
Document No.			3D148845	
OUTDOOR UNIT		RXC18A		
Casing Colour			IVORY WHITE	
Airflow Rate	High	CFM	1879	1833
Sound Pressure Level		dBA	53	
Fan	Type		PROPELLER	
	Drive		DIRECT	
Fan Motor	Type		DIRECT CURRENT	
	Index of protection (IP)		23	
	Insulation Grade		E	
	Running Current (Rated)	A	1.30	
	Power Consumption (Rated)	W	85	
	Motor Output	W	55	
Compressor	Poles		8	
	Type		HERMETIC SWING	
	Model		2Y147BKBX1A#A	
	Oil type		DAPHNE FW68DA	
	Oil amount	oz (cm <sup>3</sup> )	22.0 (650)	
Heat Exchanger Type			FIN TUBE	
Dimensions (H x W x D)	inch (mm)		27-13/32 x 36-5/8 x 13-13/16 (696 x 930 x 351)	
Packaged Dimensions (H x W x D)	inch (mm)		29-7/8 x 42-3/8 x 18-7/8 (760 x 1075 x 480)	
Weight	lbs (kg)		101 (46)	
Gross Weight	lbs (kg)		110 (50)	
Document No.			3D148691	

1) ALL UNITS ARE BEING TESTED ACCORDING TO AHRI 210/240 STANDARD.  
 2) ALL SPECIFICATIONS ARE SUBJECTED TO CHANGE BY THE MANUFACTURER WITHOUT PRIOR NOTICE.

COOLING		HEATING	
INDOOR: 80°FDB (26.7°CDB) / 67°FWB (19.4°CWB)		INDOOR: 70°FDB (21.1°CDB)	
OUTDOOR: 95°FDB (35°CDB)		OUTDOOR: 47°FDB (8.3°CDB) / 43°FWB (6.1°CWB)	

MODEL	INDOOR UNIT		FTXC24A	
	OUTDOOR UNIT		RXC24A	
			Cooling	Heating
Rated Capacity (Min. ~ Max.)		kW	6.57 (2.02 - 7.09)	6.74 (1.70 - 8.00)
		Btu/h	22400 (6900 - 24200)	23000 (5800 - 27300)
Moisture Removal		gal/h	0.88	
Rated Running Current		A	9.28	8.62
Rated Power Consumption		W	2133	1983
EER2		Btu/h/W	10.50	N/A
SEER2			18.00	N/A
COP		W/W	N/A	3.40
HSPF2			N/A	9.00
Power Factor (Rated)			N/A	
Piping Connections	Liquid	inch (mm)	1/4" (6.35)	
	Gas	inch (mm)	5/8" (15.88)	
Refrigerant	Type		R32	
	Charge	lbs (kg)	3.31 (1.50)	
Max. Interunit Piping Length		ft (m)	98-1/2 (30)	
Max. Interunit Height Difference		ft (m)	32-13/16 (10)	
Chargeless		ft (m)	32-13/16 (10)	
Amount of Additional Charge of Refrigerant		oz/ft (g/m)	0.18 (17)	
Drawing No.			3D148846	
INDOOR UNIT		FTXC24A		
Front Panel Colour		WHITE		
Airflow Rate	Turbo	CFM	754	
	High	CFM	716	
	Medium	CFM	605	
	Low	CFM	467	
	Quiet	CFM	395	
Sound Pressure Level (H/M/L/Q)		dBA	51/44/38/34	48/42/37/34
Fan	Type	CROSS FLOW		
	Drive	DIRECT		
	Speed	3 STEPS, AUTO, QUIET, TURBO		
Fan Motor	Type	DIRECT CURRENT		
	Motor Output	W	39	
	Running Current (Rated)	A	0.17	
	Power Consumption (Rated)	W	54	
Air Direction Control		UP, DOWN, LEFT, RIGHT		
Air Filter		CATECHIN		
Dimensions (H x W x D)		inch (mm)	11-11/16 x 39-9/16 x 11-1/3 (297 x 990 x 288)	
Packaged Dimensions (H x W x D)		inch (mm)	14-3/4 x 14-5/8 x 42-1/4 (375 x 371 x 1073)	
Weight		lbs (kg)	30.5 (13.8)	
Gross Weight		lbs (kg)	36 (16.5)	
Condensate Drain Size		inch (mm)	5/8 (16)	
Document No.			3D148845	
OUTDOOR UNIT		RXC24A		
Casing Colour		IVORY WHITE		
Airflow Rate	High	CFM	1879	1833
Sound Pressure Level		dBA	53	52
Fan	Type	PROPELLER		
	Drive	DIRECT		
Fan Motor	Type	DIRECT CURRENT		
	Index of protection (IP)	23		
	Insulation Grade	E		
	Running Current (Rated)	A	1.30	
	Power Consumption (Rated)	W	88	
	Motor Output	W	55	
Compressor	Poles	8		
	Type	HERMETIC SWING		
	Model	2Y147BKBX1A#A		
	Oil type	DAPHNE FW68DA		
	Oil amount	oz (cm <sup>3</sup> )	22.0 (650)	
Heat Exchanger Type		FIN TUBE		
Dimensions (H x W x D)		inch (mm)	27-13/32 x 36-5/8 x 13-13/16 (696 x 930 x 351)	
Packaged Dimensions (H x W x D)		inch (mm)	29-7/8 x 42-3/8 x 18-7/8 (760 x 1075 x 480)	
Weight		lbs (kg)	101 (46)	
Gross Weight		lbs (kg)	110 (50)	
Document No.			3D148691	

1) ALL UNITS ARE BEING TESTED ACCORDING TO AHRI 210/240 STANDARD.  
 2) ALL SPECIFICATIONS ARE SUBJECTED TO CHANGE BY THE MANUFACTURER WITHOUT PRIOR NOTICE.

COOLING		HEATING	
INDOOR: 80°FDB (26.7°CDB) / 67°FWB (19.4°CWB)		INDOOR: 70°FDB (21.1°CDB)	
OUTDOOR: 95°FDB (35°CDB)		OUTDOOR: 47°FDB (8.3°CDB) / 43°FWB (6.1°CWB)	

# Dimensions

## Indoor Unit

Model : FTXC09/12A

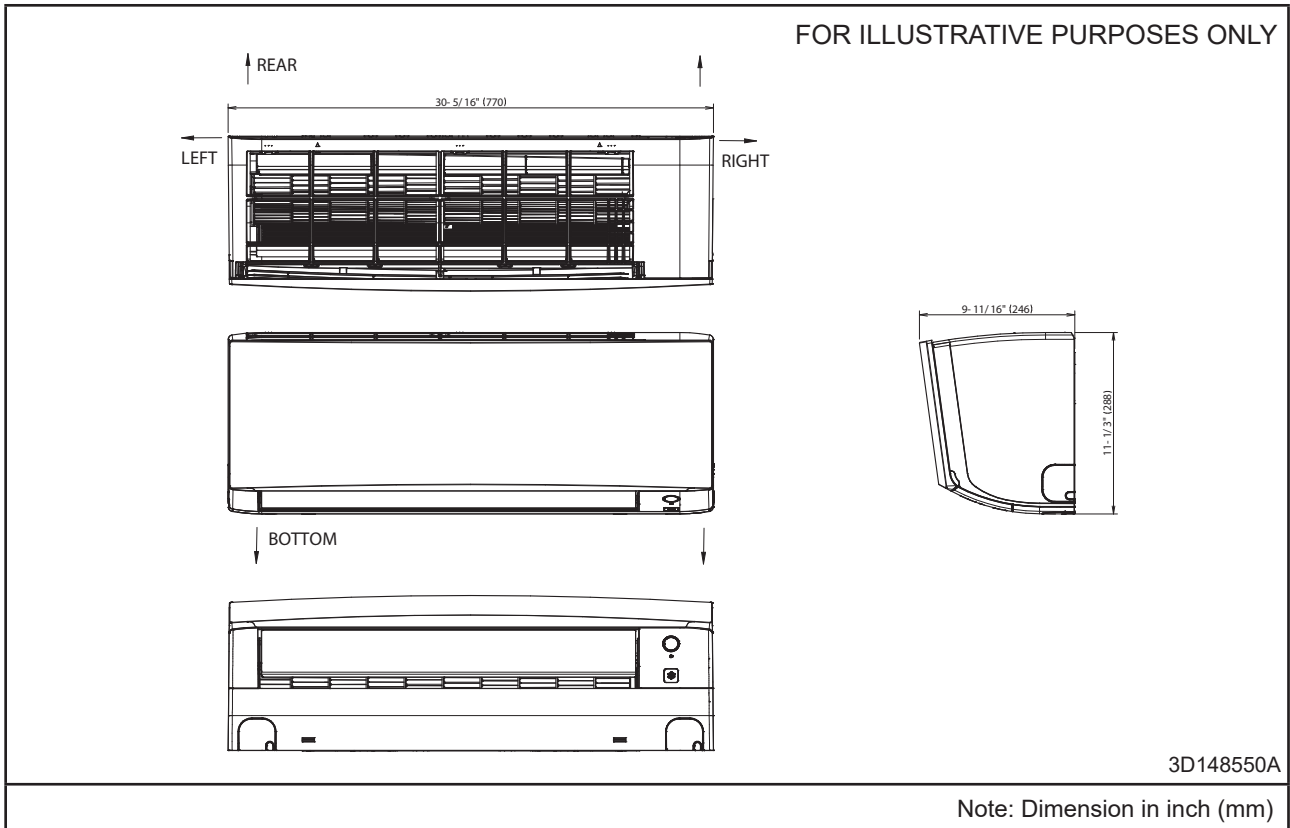

Model : FTXC18/24A

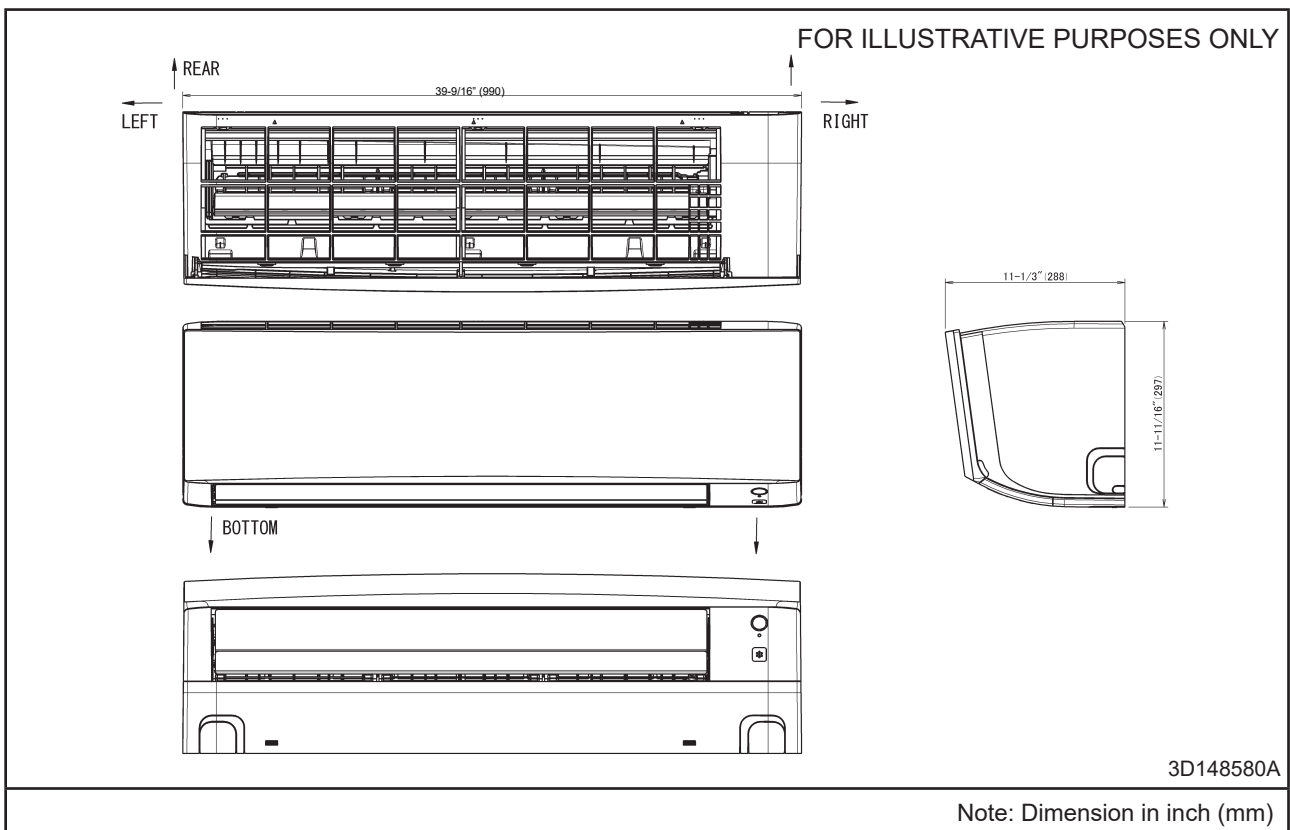

# Outdoor Unit

Model : RXC09/12A

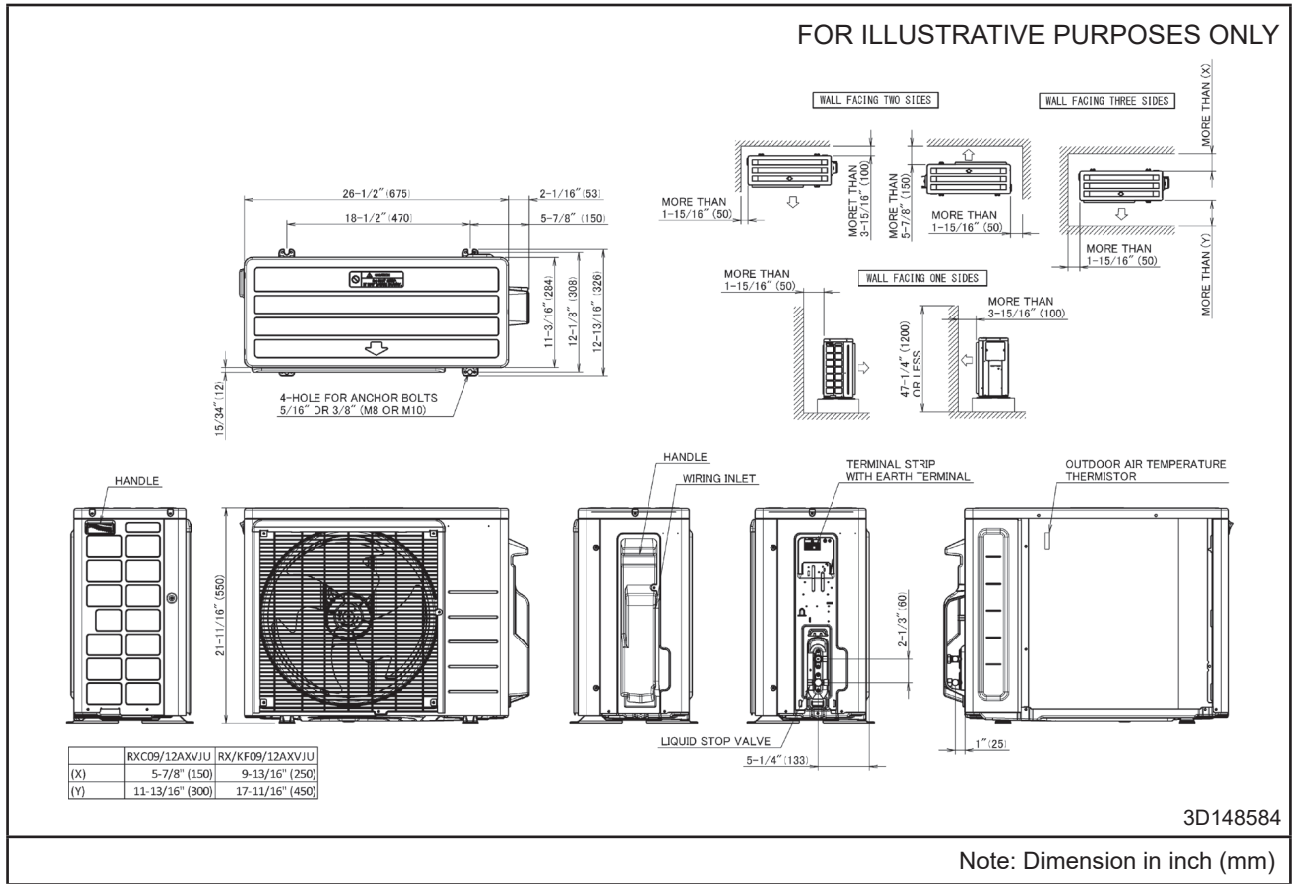

Model : RXC18/24A

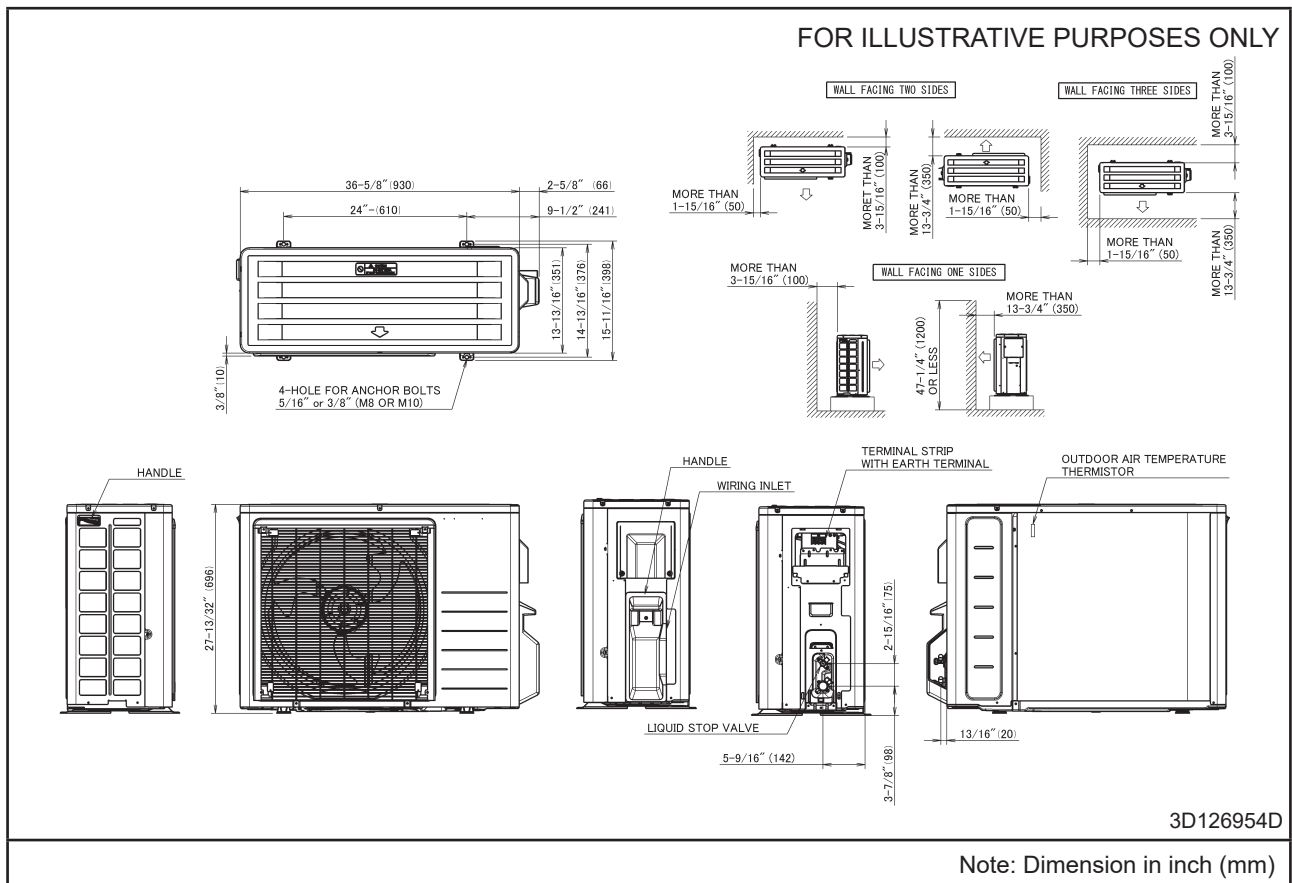

# Wiring Diagrams

## Indoor Unit

Model : FTXC-A

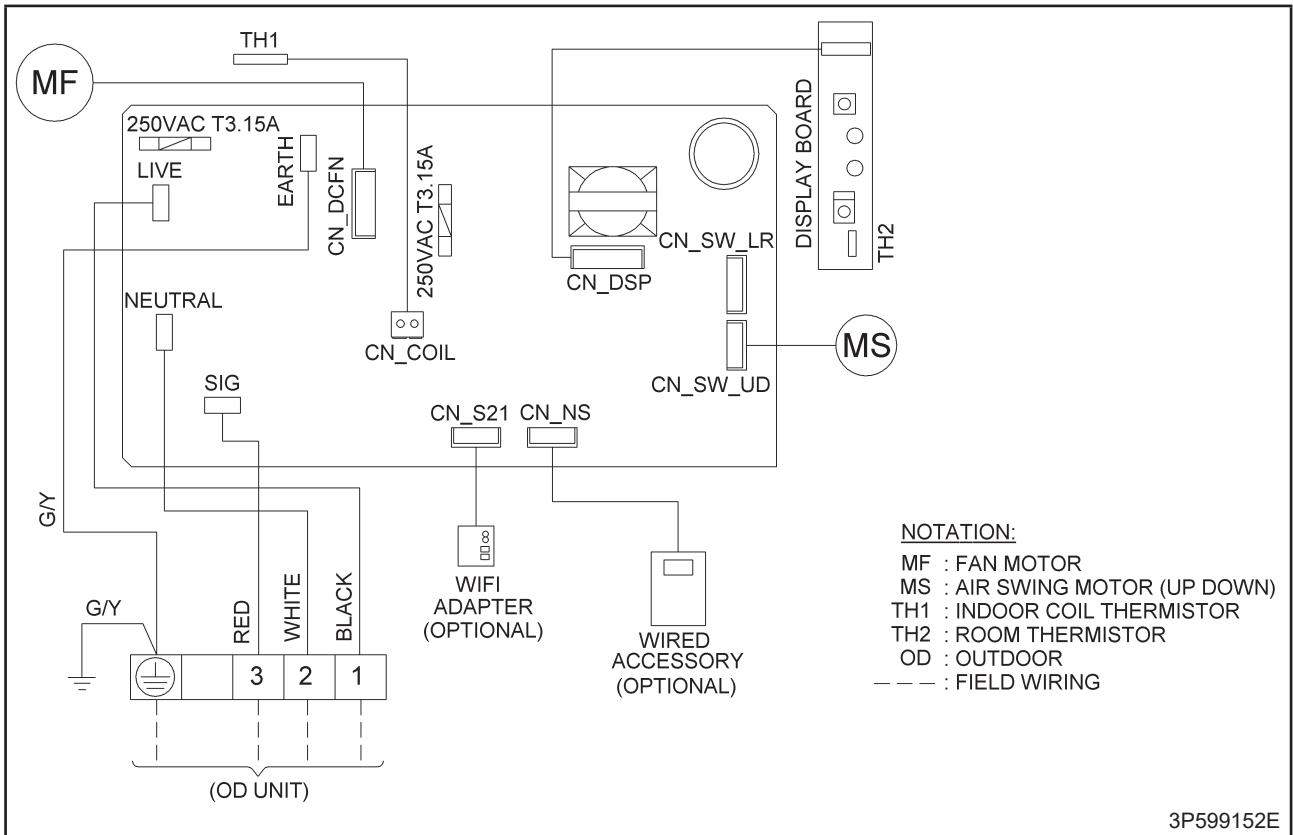

# Outdoor Unit

Model : RXC09/12A

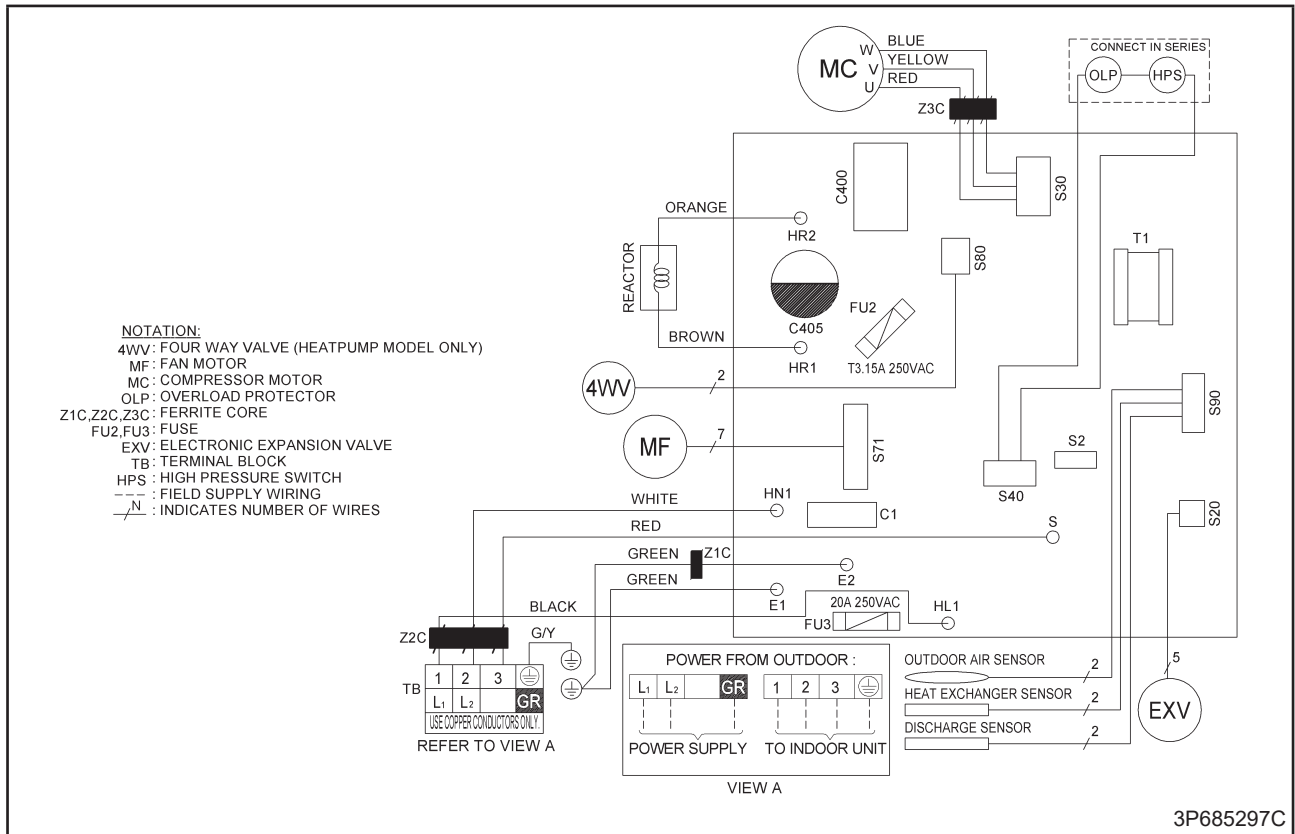

Model : RXC18/24A

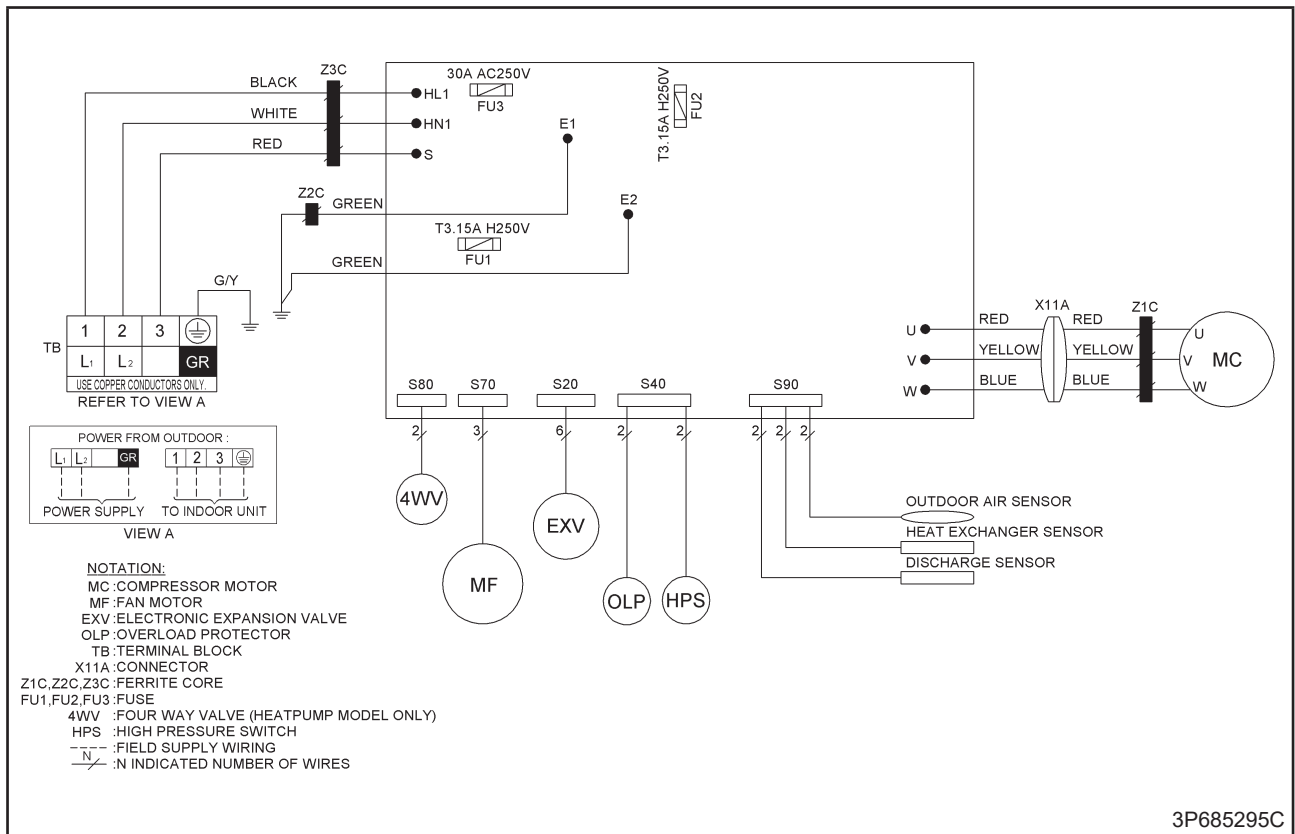

# Piping Diagrams

## Indoor Unit

Model : FTXC09A

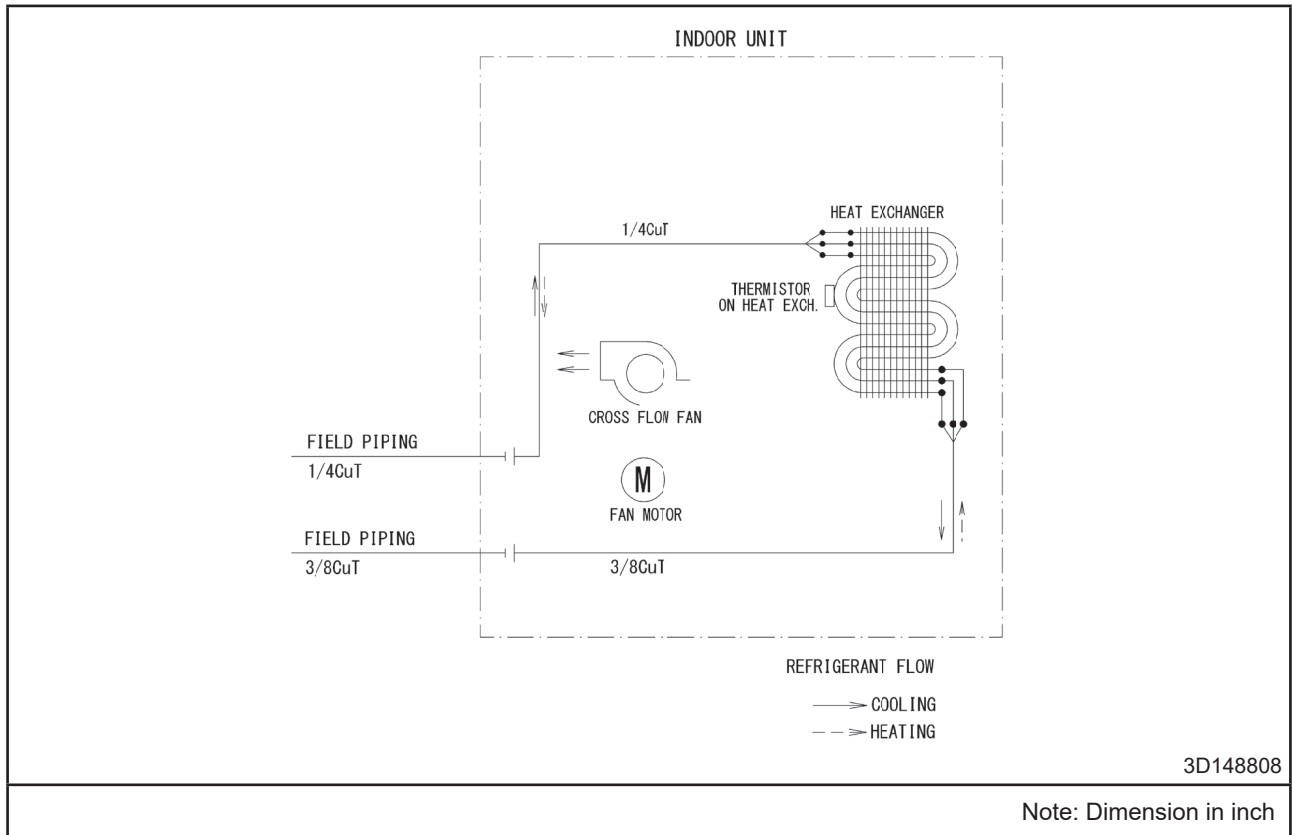

Model : FTXC12A

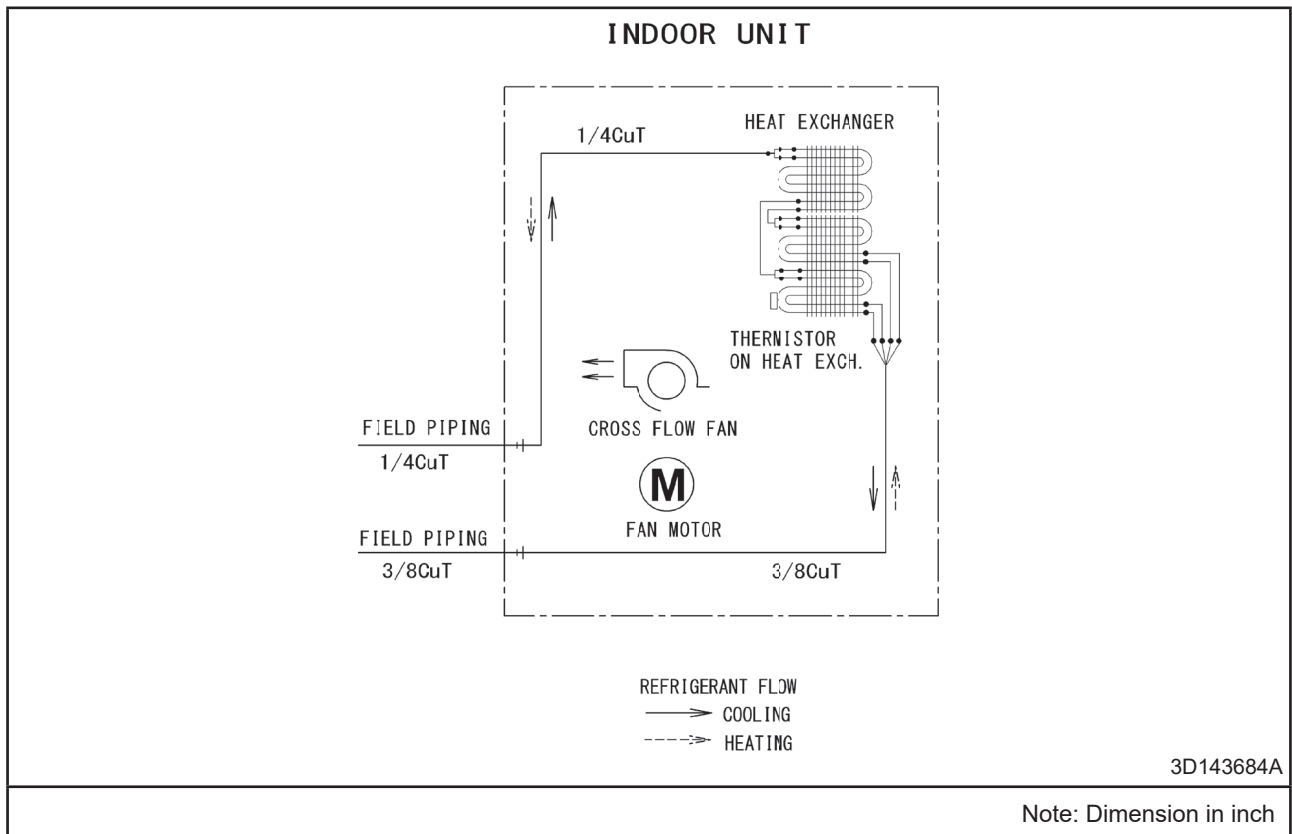



Model : FTXC18A

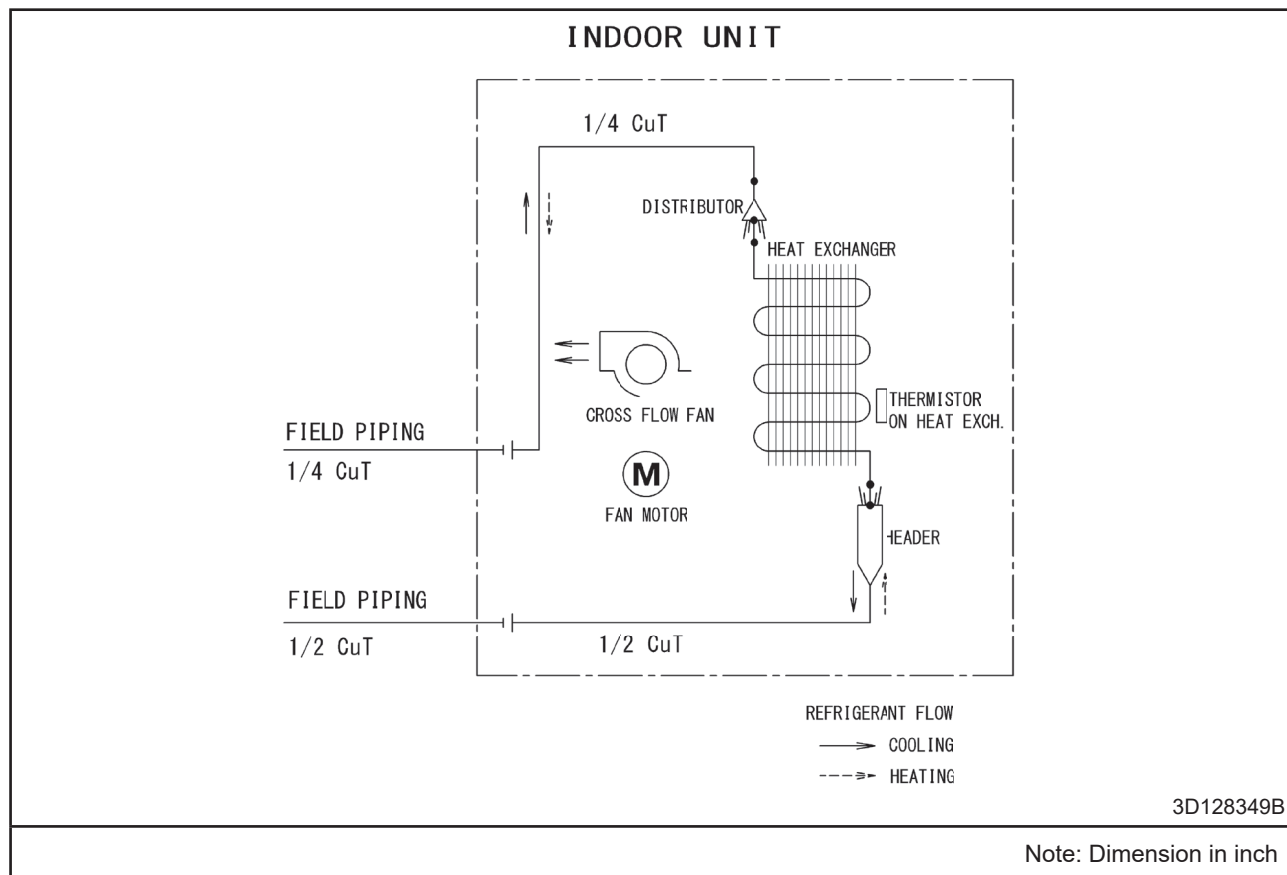

Model : FTXC24A

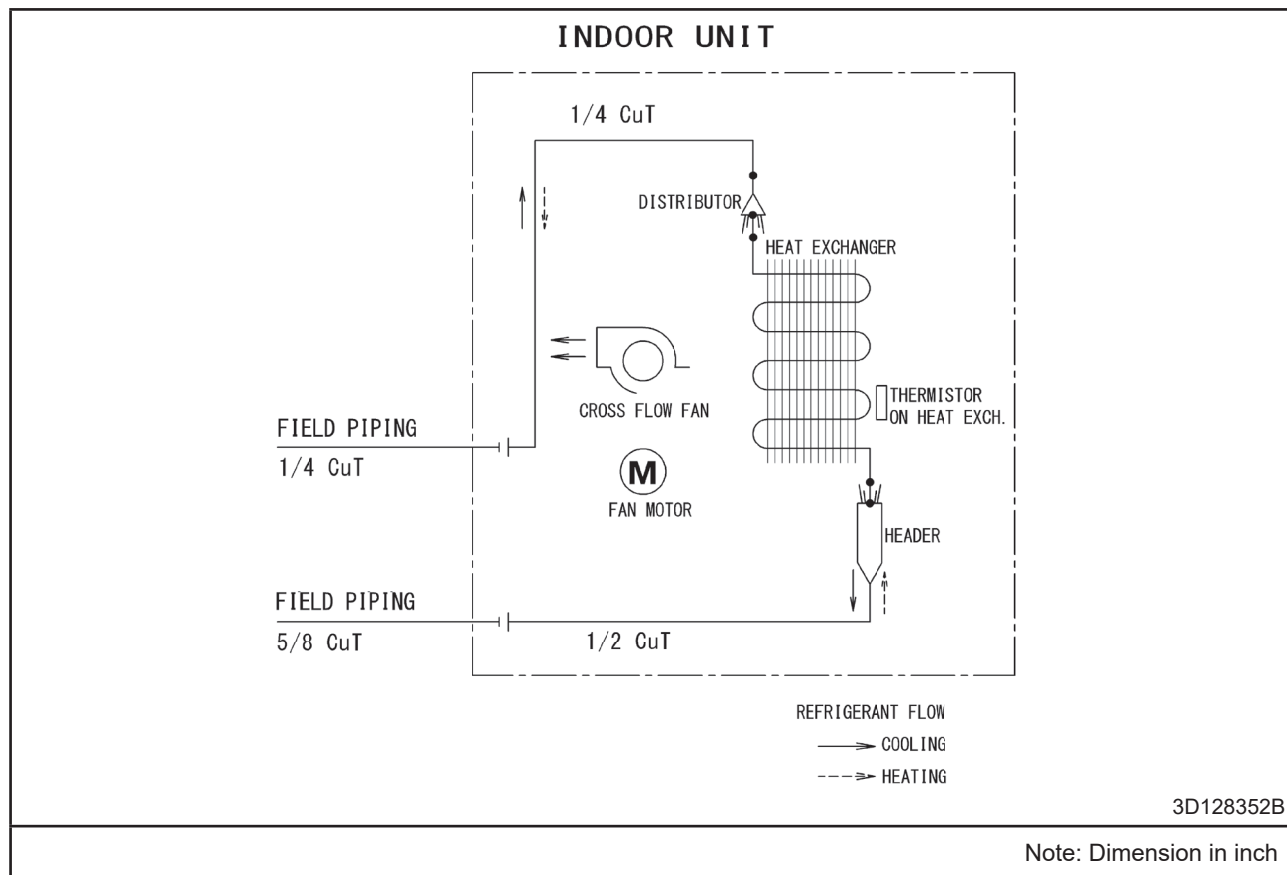

# Outdoor Unit

Model : RXC09/12A

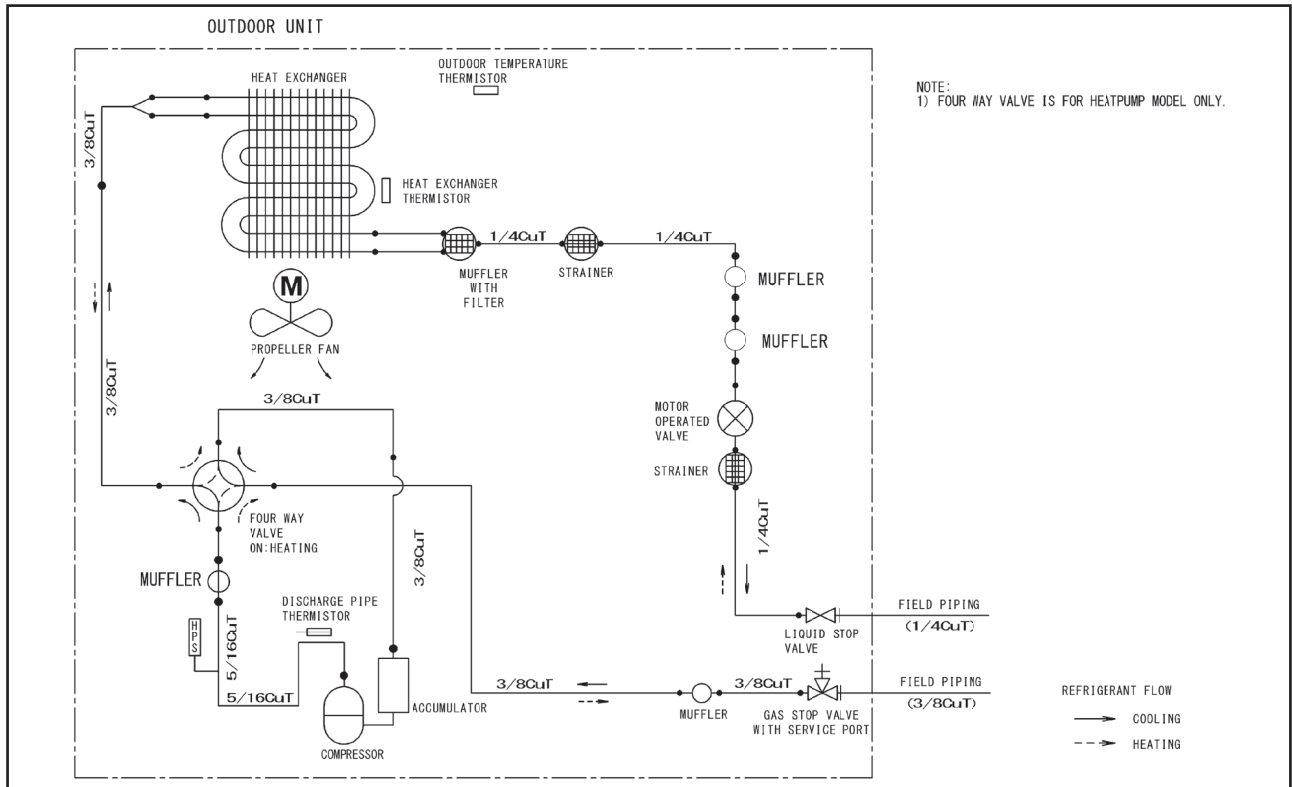

3D148805

Note: Dimension in inch

Model : RXC18A

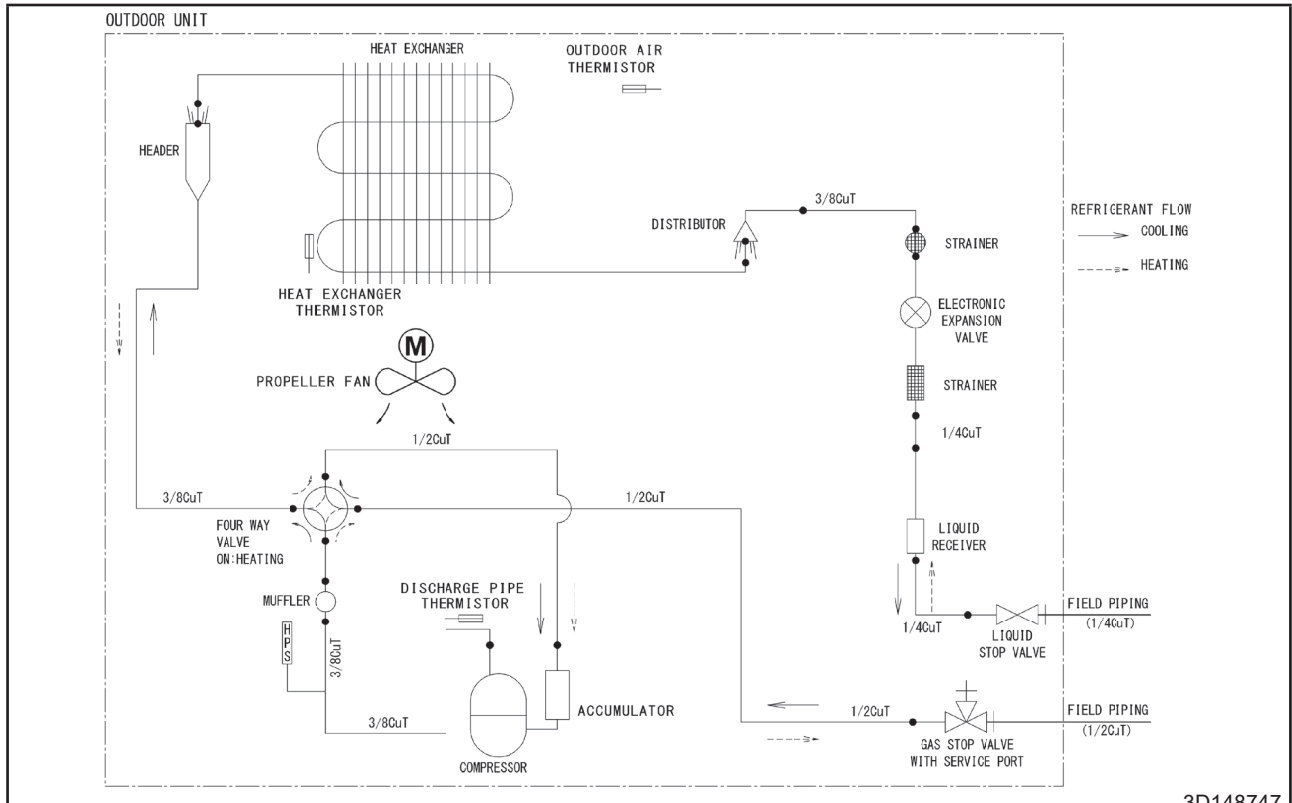

3D148747

Note: Dimension in inch

Model : RXC24A

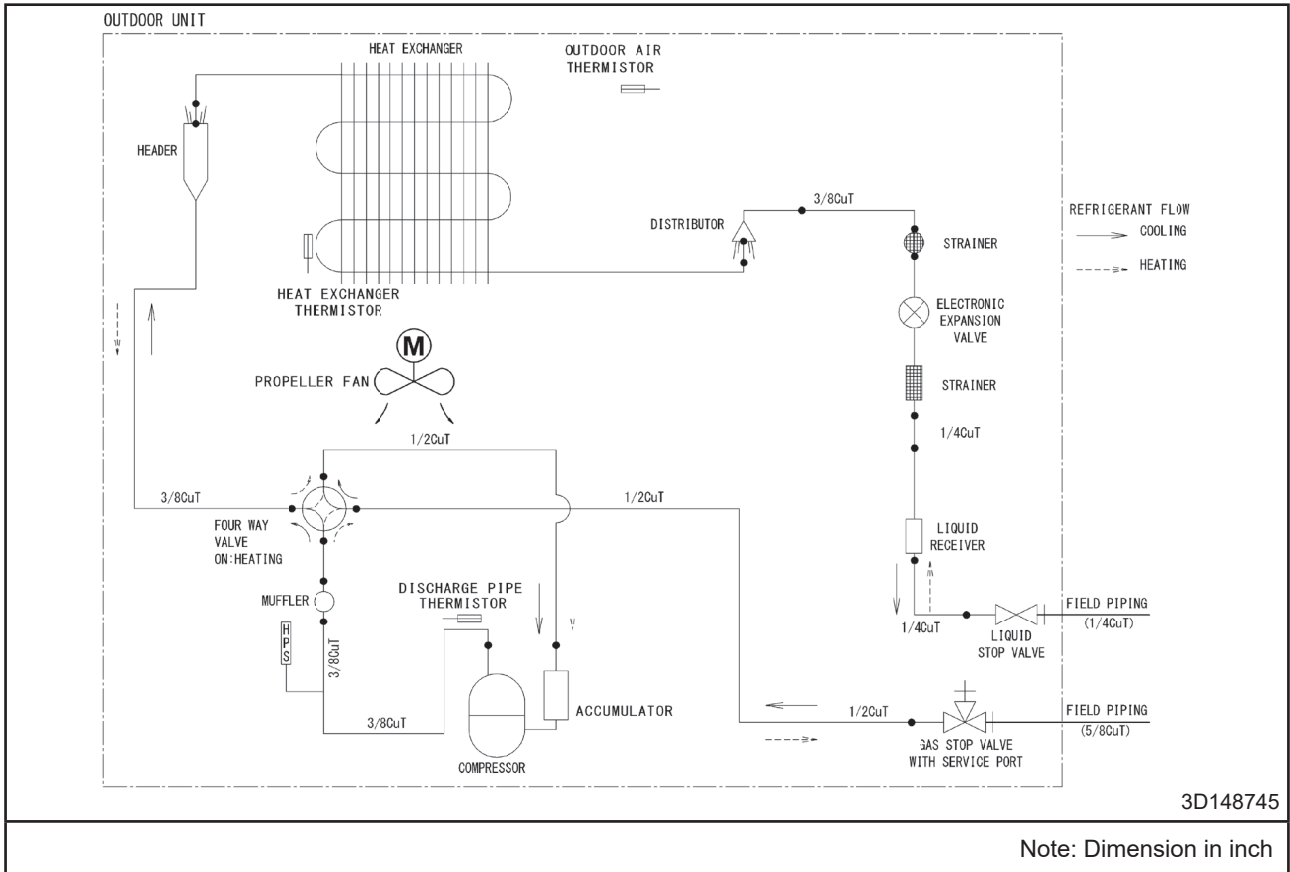

# Capacity Tables

Model : FTXC09A - RXC09A

AFR	12.20
BPF	0.23

Cooling 208-230V 60Hz  
Temp.: Celsius/TC,SHC,PI:KW

Indoor Temperature		Outdoor temperature [°C DB]																							
°C		10.0			20.0			25.0			30.0			32.0			35.0			40.0			46.0		
EWB	EDB	TC	SHC	PI	TC	SHC	PI	TC	SHC	PI	TC	SHC	PI	TC	SHC	PI	TC	SHC	PI	TC	SHC	PI	TC	SHC	PI
14.0	20.0	3.18	2.53	0.62	2.70	2.31	0.63	2.58	2.25	0.69	2.45	2.19	0.75	2.41	2.17	0.77	2.33	2.14	0.81	2.21	2.08	0.87	2.10	1.06	0.53
16.0	22.0	3.46	2.55	0.62	2.83	2.27	0.63	2.70	2.21	0.69	2.57	2.16	0.75	2.53	2.14	0.78	2.45	2.11	0.81	2.33	2.06	0.87	2.15	1.13	0.52
18.0	25.0	3.74	2.74	0.63	2.95	2.41	0.63	2.83	2.36	0.70	2.70	2.31	0.75	2.65	2.29	0.78	2.57	2.26	0.82	2.45	2.21	0.88	2.24	1.20	0.51
19.4	26.7	3.88	2.92	0.63	3.01	2.57	0.63	2.88	2.52	0.70	2.76	2.48	0.75	2.71	2.46	0.78	2.64	2.43	0.82	2.52	2.38	0.88	2.29	1.24	0.51
22.0	30.0	4.30	2.89	0.63	3.19	2.49	0.64	3.07	2.45	0.70	2.94	2.41	0.76	2.89	2.39	0.79	2.82	2.37	0.83	2.70	2.33	0.89	1.42	1.35	0.49
24.0	32.0	4.58	2.86	0.64	3.31	2.44	0.65	3.19	2.40	0.71	3.07	2.36	0.77	3.01	2.35	0.79	2.94	2.32	0.83	2.82	2.29	0.89	1.51	1.43	0.48

Cooling 208-230V 60Hz  
Temp.: Fahrenheit/TC,SHC: kBTu/h / PI:KW

Indoor Temperature		Outdoor temperature [°F DB]																							
°F		50.0			68.0			77.0			86.0			89.6			95.0			104.0			114.8		
EWB	EDB	TC	SHC	PI	TC	SHC	PI	TC	SHC	PI	TC	SHC	PI	TC	SHC	PI	TC	SHC	PI	TC	SHC	PI	TC	SHC	PI
57.2	68.0	10.83	8.64	0.62	9.22	7.87	0.63	8.80	7.67	0.69	8.38	7.48	0.75	8.21	7.40	0.77	7.96	7.29	0.81	7.53	7.09	0.87	3.63	3.63	0.53
60.8	71.6	11.79	8.69	0.62	9.64	7.73	0.63	9.22	7.55	0.69	8.78	7.36	0.75	8.63	7.30	0.78	8.38	7.19	0.81	7.96	7.01	0.87	3.94	3.85	0.52
64.4	77.0	12.75	9.34	0.63	10.06	8.22	0.63	9.64	8.06	0.70	9.22	7.88	0.75	9.05	7.82	0.78	8.78	7.71	0.82	8.37	7.55	0.88	4.24	4.10	0.51
66.9	80.1	13.22	9.96	0.63	10.25	8.77	0.63	9.84	8.61	0.70	9.41	8.45	0.75	9.25	8.38	0.78	9.00	8.29	0.82	8.59	7.83	0.88	4.40	4.23	0.51
71.6	86.0	14.66	9.86	0.63	10.88	8.51	0.64	10.47	8.36	0.70	10.04	8.22	0.76	9.87	8.16	0.79	9.62	8.08	0.83	9.22	7.94	0.89	4.86	4.61	0.49
75.2	89.6	15.61	9.75	0.64	11.29	8.32	0.65	10.88	8.19	0.71	10.47	8.06	0.77	10.29	8.01	0.79	10.04	7.93	0.83	9.62	7.80	0.89	5.16	4.87	0.48

Heating: 208-230V 60Hz  
Temp.: Celsius/TC,SHC:PI:KW

Indoor Temperature		Outdoor temperature [°C WB]																							
°C		-15.0			-10.0			-5.0			0.0			6.1			10.0			18.0					
EWB	EDB	TC	SHC	PI	TC	SHC	PI	TC	SHC	PI	TC	SHC	PI	TC	SHC	PI	TC	SHC	PI	TC	SHC	PI	TC	SHC	PI
15.0	15.0	1.43	0.46	1.45	0.49	1.80	0.50	2.06	0.66	2.85	0.75	3.10	0.77	3.54	0.83	3.85	0.85	4.24	0.88	4.61	0.91	4.94	0.93	5.27	0.95
21.1	21.1	1.35	0.48	1.38	0.50	1.72	0.51	1.98	0.68	2.75	0.77	3.01	0.79	3.45	0.85	3.85	0.85	4.24	0.88	4.61	0.91	4.94	0.93	5.27	0.95
22.0	22.0	1.31	0.48	1.35	0.51	1.69	0.52	1.95	0.68	2.72	0.77	2.97	0.80	3.41	0.85	3.85	0.85	4.24	0.88	4.61	0.91	4.94	0.93	5.27	0.95
24.0	24.0	1.27	0.48	1.32	0.51	1.65	0.53	1.91	0.69	2.68	0.78	2.93	0.80	3.37	0.86	3.85	0.86	4.24	0.88	4.61	0.91	4.94	0.93	5.27	0.95
25.0	25.0	1.25	0.49	1.30	0.51	1.64	0.53	1.90	0.69	2.66	0.78	2.91	0.81	3.35	0.86	3.85	0.86	4.24	0.88	4.61	0.91	4.94	0.93	5.27	0.95
27.0	27.0	1.22	0.49	1.28	0.52	1.61	0.53	1.87	0.70	2.62	0.79	2.87	0.81	3.32	0.87	3.85	0.87	4.24	0.88	4.61	0.91	4.94	0.93	5.27	0.95

Heating: 208-230V 60Hz  
Temp.: Fahrenheit/TC,SHC:PI:KW

Indoor Temperature		Outdoor temperature [°F WB]																							
°F		5.0			14.0			23.0			32.0			43.0			50.0			64.4					
EWB	EDB	TC	SHC	PI	TC	SHC	PI	TC	SHC	PI	TC	SHC	PI	TC	SHC	PI	TC	SHC	PI	TC	SHC	PI	TC	SHC	PI
59.0	59.0	4.88	0.46	4.96	0.49	6.14	0.50	7.03	0.66	9.72	0.75	10.58	0.77	12.09	0.83	13.60	0.85	15.11	0.87	16.62	0.89	18.13	0.91	19.64	0.93
70.0	70.0	4.60	0.48	4.71	0.50	5.87	0.51	6.76	0.68	9.40	0.77	10.25	0.79	11.77	0.85	13.28	0.87	14.79	0.89	16.30	0.91	17.81	0.93	19.32	0.95
71.6	71.6	4.46	0.48	4.61	0.51	5.76	0.52	6.65	0.68	9.26	0.77	10.12	0.80	11.64	0.85	13.15	0.87	14.66	0.89	16.17	0.91	17.69	0.93	19.21	0.95
75.2	75.2	4.34	0.48	4.51	0.51	5.65	0.53	6.53	0.69	9.14	0.78	9.99	0.80	11.51	0.86	13.02	0.87	14.54	0.89	16.05	0.91	17.57	0.93	19.10	0.95
77.0	77.0	4.28	0.49	4.44	0.51	5.61	0.53	6.49	0.69	9.08	0.78	9.92	0.81	11.44	0.86	12.91	0.87	14.43	0.89	15.96	0.91	17.49	0.93	19.02	0.95
80.6	80.6	4.17	0.49	4.35	0.52	5.48	0.53	6.37	0.70	8.94	0.79	9.80	0.81	11.31	0.87	12.80	0.87	14.32	0.89	15.85	0.91	17.40	0.93	18.91	0.95

Symbols

- AFR Air Flow rate (m<sup>3</sup>/min)
- BPF Bypass factor
- EWB Entering Wet Bulb (°C) / (°F)
- EDB Entering Dry Bulb (°C) / (°F)
- TC Total Capacity (kW) / (kBTu/h)
- SHC Sensible Heat Capacity (kW) / (kBTu/h)
- PI Power Input (kW)

NOTES:

- 1) Shows nominal(rated) capacities and power inpt.
- 2) TC, SHC and PI must be calculated by interpolation using the figures in the above table.
- 3) Capacities are based on the following condition:  
Corresponding refrigerant piping length :25ft  
Level difference :0ft

3D148833D

Model : FTXC12A - RXC12A

AFR	12.35
BPF	0.22

Cooling 208-230V 60Hz  
Temp.: Celsius/TC,SHC,PI:kW

Indoor Temperature EDB	Outdoor temperature [°C DB]																								
	10.0			20.0			25.0			30.0			32.0			35.0			40.0			46.0			
°C	TC	SHC	PI	TC	SHC	PI	TC	SHC	PI	TC	SHC	PI	TC	SHC	PI	TC	SHC	PI	TC	SHC	PI	TC	SHC	PI	
14.0	20.0	4.23	3.08	1.07	3.60	2.76	1.08	3.44	2.68	1.19	3.27	2.60	1.29	3.21	2.56	1.33	3.11	2.52	1.40	2.94	2.44	1.50	1.42	1.42	0.91
16.0	22.0	4.61	3.11	1.07	3.77	2.71	1.09	3.60	2.63	1.19	3.43	2.55	1.30	3.37	2.48	1.40	3.11	2.41	1.51	1.54	1.51	1.54	1.51	1.51	0.90
18.0	25.0	4.98	3.32	1.08	3.93	2.84	1.09	3.77	2.77	1.20	3.60	2.70	1.30	3.54	2.67	1.35	3.43	2.63	1.41	3.27	2.56	1.51	1.66	1.60	0.88
19.4	26.7	5.17	3.50	1.08	4.01	3.00	1.09	3.85	2.93	1.20	3.68	2.86	1.30	3.61	2.84	1.35	3.52	2.80	1.41	3.36	2.73	1.52	1.72	1.65	0.87
22.0	30.0	5.73	3.47	1.09	4.25	2.89	1.11	4.09	2.83	1.21	3.92	2.77	1.32	3.86	2.75	1.36	3.76	2.72	1.42	3.60	2.66	1.53	1.90	1.80	0.85
24.0	32.0	6.10	3.43	1.10	4.41	2.82	1.12	4.25	2.77	1.22	4.09	2.71	1.33	4.02	2.69	1.37	3.92	2.66	1.43	3.76	2.61	1.54	2.02	1.90	0.84

Cooling 208-230V 60Hz  
Temp.: Fahrenheit/TC,SHC:kBtu/h /PI: kW

Indoor Temperature EDB	Outdoor temperature [°F DB]																								
	50.0			68.0			77.0			86.0			89.6			95.0			104.0			114.8			
°F	TC	SHC	PI	TC	SHC	PI	TC	SHC	PI	TC	SHC	PI	TC	SHC	PI	TC	SHC	PI	TC	SHC	PI	TC	SHC	PI	
57.2	68.0	14.45	10.52	1.07	12.30	9.41	1.08	11.73	9.13	1.19	11.17	8.86	1.29	10.95	8.75	1.33	10.62	8.59	1.40	10.05	8.32	1.50	4.84	4.84	0.91
60.8	71.6	15.72	10.62	1.07	12.86	9.24	1.09	12.29	8.98	1.19	11.71	8.71	1.30	11.51	8.62	1.34	11.17	8.47	1.40	10.62	8.22	1.51	5.25	5.14	0.90
64.4	77.0	16.99	11.32	1.08	13.41	9.69	1.09	12.86	9.46	1.20	12.29	9.21	1.30	12.07	9.12	1.35	11.71	8.97	1.41	11.16	8.74	1.51	5.66	5.47	0.88
66.9	80.1	17.63	11.96	1.08	13.67	10.23	1.09	13.12	10.00	1.20	12.55	9.76	1.30	12.33	9.67	1.35	12.00	9.54	1.41	11.45	9.32	1.52	5.86	5.64	0.87
71.6	86.0	19.54	11.85	1.09	14.51	9.88	1.11	13.95	9.67	1.21	13.38	9.47	1.32	13.16	9.39	1.36	12.82	9.27	1.42	12.29	9.08	1.53	6.48	6.14	0.85
75.2	89.6	20.82	11.71	1.10	15.06	9.63	1.12	14.51	9.44	1.22	13.95	9.26	1.33	13.72	9.18	1.37	13.38	9.07	1.43	12.82	8.89	1.54	6.88	6.49	0.84

Heating: 208-230V 60Hz  
Temp.: Celsius/TC,PI: kW

Indoor Temperature EDB	Outdoor temperature [°C WB]																			
	-15.0			-10.0			-5.0			0.0			6.1			10.0			18.0	
°C	TC	PI	TC	PI	TC	PI	TC	PI	TC	PI	TC	PI	TC	PI	TC	PI	TC	PI	TC	PI
15.0	1.71	0.61	1.75	0.64	2.16	0.66	2.48	0.86	3.43	0.98	3.73	1.02	4.26	1.09						
21.1	1.61	0.62	1.66	0.65	2.07	0.67	2.38	0.89	3.31	1.00	3.61	1.04	4.15	1.11						
22.0	1.56	0.63	1.62	0.66	2.03	0.68	2.34	0.89	3.26	1.01	3.57	1.05	4.10	1.12						
24.0	1.52	0.64	1.59	0.67	1.99	0.69	2.30	0.90	3.22	1.02	3.52	1.06	4.06	1.13						
25.0	1.50	0.64	1.57	0.67	1.98	0.69	2.29	0.91	3.20	1.02	3.49	1.06	4.03	1.13						
27.0	1.46	0.65	1.53	0.68	1.93	0.70	2.25	0.91	3.15	1.04	3.45	1.07	3.99	1.14						

Heating: 208-230V 60Hz  
Temp.: Fahrenheit/TC:kBtu/h /PI: kW

Indoor Temperature EDB	Outdoor temperature [°F WB]																			
	5.0			14.0			23.0			32.0			43.0			50.0			64.4	
°F	TC	PI	TC	PI	TC	PI	TC	PI	TC	PI	TC	PI	TC	PI	TC	PI	TC	PI	TC	PI
59.0	5.83	0.61	5.96	0.64	7.38	0.66	8.45	0.86	11.69	0.98	12.71	1.02	14.54	1.09						
70.0	5.50	0.62	5.66	0.65	7.06	0.67	8.13	0.89	11.30	1.00	12.33	1.04	14.15	1.11						
71.6	5.34	0.63	5.54	0.66	6.93	0.68	7.99	0.89	11.14	1.01	12.17	1.05	13.99	1.12						
75.2	5.19	0.64	5.42	0.67	6.79	0.69	7.85	0.90	10.99	1.02	12.01	1.06	13.84	1.13						
77.0	5.12	0.64	5.34	0.67	6.74	0.69	7.81	0.91	10.91	1.02	11.92	1.06	13.76	1.13						
80.6	4.98	0.65	5.23	0.68	6.59	0.70	7.66	0.91	10.75	1.04	11.78	1.07	13.60	1.14						

Symbols

- AFR Air Flow rate (m<sup>3</sup>/min)
- BPF Bypass factor (°C) / (°F)
- EWB Entering Wet Bulb (°C) / (°F)
- EDB Entering Dry Bulb (kW) / (kBtu/h)
- TC Total Capacity (kW) / (kBtu/h)
- SHC Sensible Heat Capacity (kW)
- PI Power Input

NOTES:

- 1) Shows nominal(rated) capacities and power input
- 2) TC, SHC and PI must be calculated by interpolation using the figures in the above tab
- 3) Capacities are based on the following conditions:  
Corresponding refrigerant piping length :25ft  
Level difference :0ft

Model : FTXC18A - RXC18A

AFR	20.27
BPF	0.32

Cooling 208-230V 60Hz  
Temp.: Celsius/TC,SHC,PI: kW

Indoor Temperature EWB	Outdoor temperature [°C DB]																								
	10.0			20.0			25.0			30.0			35.0			40.0			46.0						
°C	TC	SHC	PI	TC	SHC	PI	TC	SHC	PI	TC	SHC	PI	TC	SHC	PI	TC	SHC	PI	TC	SHC	PI				
14.0	20.0	5.95	4.37	1.09	5.44	4.11	1.32	5.18	3.98	1.44	4.94	3.86	1.57	4.84	3.81	1.62	4.69	3.74	1.71	4.44	3.62	1.83	3.75	3.29	1.90
16.0	22.0	6.20	4.28	1.10	5.68	4.03	1.33	5.43	3.91	1.45	5.18	3.79	1.58	5.09	3.75	1.64	4.94	3.69	1.71	4.69	3.57	1.84	4.01	3.28	1.89
18.0	25.0	6.44	4.45	1.11	5.93	4.22	1.33	5.68	4.11	1.47	5.43	4.01	1.59	5.34	3.96	1.64	5.18	3.90	1.72	4.93	3.79	1.84	4.28	3.53	1.88
19.4	26.7	6.56	4.67	1.11	6.04	4.45	1.33	5.80	4.34	1.47	5.55	4.24	1.59	5.45	4.20	1.64	5.30	4.14	1.72	5.06	4.04	1.86	4.41	3.78	1.87
22.0	30.0	6.93	4.49	1.12	6.41	4.29	1.35	6.17	4.20	1.48	5.92	4.11	1.60	5.82	4.07	1.65	5.67	4.02	1.73	5.43	3.93	1.86	4.80	3.71	1.86
24.0	32.0	7.17	4.36	1.13	6.66	4.18	1.36	6.41	4.10	1.48	6.17	4.02	1.62	6.06	3.98	1.67	5.92	3.93	1.74	5.67	3.85	1.87	5.07	3.66	1.84

Cooling 208-230V 60Hz  
Temp.: Fahrenheit/TC,SHC:kBtu/h/PI: kW

Indoor Temperature EWB	Outdoor temperature [°F DB]																								
	50.0			68.0			77.0			86.0			89.6			104.0			114.8						
°F	TC	SHC	PI	TC	SHC	PI	TC	SHC	PI	TC	SHC	PI	TC	SHC	PI	TC	SHC	PI	TC	SHC	PI				
57.2	68.0	20.31	14.92	1.09	18.55	14.02	1.32	17.69	13.58	1.44	16.84	13.16	1.57	16.51	13.00	1.62	16.01	12.76	1.71	15.15	12.34	1.83	12.80	11.23	1.90
60.8	71.6	21.14	14.60	1.10	19.39	13.76	1.33	18.53	13.35	1.45	17.66	12.95	1.58	17.36	12.81	1.64	16.84	12.57	1.71	16.01	12.20	1.84	13.70	11.18	1.89
64.4	77.0	21.97	15.18	1.11	20.23	14.40	1.33	19.39	14.04	1.47	18.53	13.67	1.59	18.20	13.53	1.64	17.66	13.30	1.72	16.83	12.95	1.84	14.60	12.03	1.88
66.9	80.1	22.39	15.93	1.11	20.62	15.17	1.33	19.79	14.82	1.47	18.93	14.46	1.59	18.60	14.33	1.64	18.10	14.12	1.72	17.27	13.78	1.86	15.04	12.91	1.87
71.6	86.0	23.64	15.31	1.12	21.88	14.64	1.35	21.04	14.33	1.48	20.19	14.02	1.60	19.85	13.90	1.65	19.34	13.71	1.73	18.53	13.42	1.86	16.39	12.67	1.86
75.2	89.6	24.47	14.89	1.13	22.71	14.27	1.36	21.88	13.99	1.48	21.04	13.71	1.62	20.69	13.59	1.67	20.19	13.42	1.74	19.34	13.14	1.87	17.29	12.48	1.84

Heating: 208-230V 60Hz  
Temp.: Celsius/TC,PI: kW

Indoor Temperature EDB	Outdoor temperature [°C WB]																
	-15.0			-10.0			0.0			6.1			10.0			18.0	
°C	TC	PI	TC	PI	TC	PI	TC	PI	TC	PI	TC	PI	TC	PI	TC	PI	
15.0	2.76	0.96	2.79	1.02	3.45	1.05	3.95	1.37	5.46	1.57	5.93	1.62	7.42	2.01			
21.1	2.61	1.00	2.64	1.04	3.30	1.07	3.79	1.41	5.28	1.60	5.75	1.65	6.78	1.95			
22.0	2.53	1.01	2.59	1.06	3.24	1.09	3.73	1.42	5.20	1.61	5.68	1.67	6.52	1.93			
24.0	2.46	1.01	2.53	1.07	3.17	1.10	3.67	1.44	5.13	1.62	5.61	1.68	6.27	1.91			
25.0	2.43	1.02	2.49	1.07	3.15	1.11	3.65	1.45	5.09	1.63	5.57	1.69	6.14	1.90			
27.0	2.36	1.03	2.44	1.09	3.08	1.12	3.58	1.45	5.02	1.65	5.50	1.70	5.88	1.88			

Heating: 208-230V 60Hz  
Temp.: Fahrenheit/TC,kBtu/h/PI: kW

Indoor Temperature EDB	Outdoor temperature [°F WB]																			
	5.0			14.0			23.0			32.0			43.0			50.0			64.4	
°F	TC	PI	TC	PI	TC	PI	TC	PI	TC	PI	TC	PI	TC	PI	TC	PI				
59.0	94.3	0.96	9.50	1.02	11.76	1.05	13.47	1.37	18.61	1.57	20.25	1.62	25.32	2.01						
70.0	8.90	1.00	9.01	1.04	11.25	1.07	12.95	1.41	18.00	1.60	19.63	1.65	23.13	1.95						
71.6	8.64	1.01	8.83	1.06	11.04	1.09	12.73	1.42	17.74	1.61	19.38	1.67	22.26	1.93						
75.2	8.40	1.01	8.63	1.07	10.82	1.10	12.51	1.44	17.50	1.62	19.14	1.68	21.38	1.91						
77.0	8.29	1.02	8.51	1.07	10.74	1.11	12.44	1.45	17.38	1.63	18.99	1.69	20.94	1.90						
80.6	8.06	1.03	8.34	1.09	10.51	1.12	12.21	1.45	17.12	1.65	18.76	1.70	20.06	1.88						

Symbols:

- AFR Air Flow rate (m<sup>3</sup>/min)
- BPF Bypass factor
- EWB Entering Wet Bulb (°C) / (°F)
- EDB Entering Dry Bulb (°C) / (°F)
- TC Total Capacity (kW) / (kBtu/h)
- SHC Sensible Heat Capacity (kW) / (kBtu/h)
- PI Power Input (kW)

NOTES:

- 1) Shows nominal (rated) capacities and power input
- 2) TC, SHC and PI must be calculated by interpolation using the figures in the above table
- 3) Capacities are based on the following conditions:  
Corresponding refrigerant piping length: .25ft  
Level difference: .0ft

Model : FTXC24A - RXC24A

AFR	20.27
BPF	0.27

Cooling 208-230V 60Hz  
Temp.: Celsius/TC,SHC,PI; kW

Indoor Temperature		Outdoor temperature [°C DB]																							
		10.0			20.0			25.0			30.0			32.0			35.0			40.0					
°C	°F	TC	SHC	PI	TC	SHC	PI	TC	SHC	PI	TC	SHC	PI	TC	SHC	PI	TC	SHC	PI	TC	SHC	PI			
14.0	20.0	7.37	5.21	1.35	6.73	4.87	1.63	6.42	4.70	1.79	6.11	4.54	1.94	5.99	4.48	2.01	5.81	4.39	2.11	5.50	4.23	2.27	4.64	3.81	2.36
16.0	22.0	7.67	5.09	1.36	7.03	4.77	1.64	6.72	4.62	1.80	6.41	4.47	1.96	6.30	4.41	2.03	6.11	4.32	2.11	5.81	4.18	2.28	4.97	3.80	2.34
18.0	25.0	7.97	5.26	1.37	7.34	4.96	1.65	7.03	4.82	1.82	6.72	4.68	1.97	6.60	4.63	2.03	6.41	4.54	2.13	6.11	4.41	2.28	5.29	4.06	2.33
19.4	26.7	8.12	5.48	1.38	7.48	5.19	1.65	7.18	5.06	1.82	6.87	4.92	1.97	6.75	4.87	2.03	6.57	4.79	2.13	6.26	4.67	2.30	5.46	4.34	2.32
22.0	30.0	8.57	5.26	1.39	7.94	5.00	1.67	7.63	4.88	1.83	7.32	4.76	1.98	7.20	4.72	2.05	7.02	4.65	2.15	6.72	4.54	2.31	5.95	4.25	2.30
24.0	32.0	8.88	5.10	1.40	8.24	4.86	1.68	7.94	4.76	1.84	7.63	4.65	2.00	7.50	4.60	2.07	7.32	4.54	2.15	7.02	4.43	2.32	6.27	4.18	2.28

Cooling 208-230V 60Hz  
Temp.: Fahrenheit/TC,SHC:kBtu/h/PI; kW

Indoor Temperature		Outdoor temperature [°F DB]																							
		50.0			68.0			77.0			86.0			89.6			95.0			104.0					
°F	°C	TC	SHC	PI	TC	SHC	PI	TC	SHC	PI	TC	SHC	PI	TC	SHC	PI	TC	SHC	PI	TC	SHC	PI			
57.2	68.0	25.13	17.79	1.35	22.96	16.61	1.63	21.89	16.04	1.79	20.85	15.50	1.94	20.44	15.29	2.01	19.82	14.97	2.11	18.75	14.44	2.27	15.84	13.02	2.36
60.8	71.6	26.16	17.38	1.36	24.00	16.29	1.64	22.94	15.76	1.80	21.86	15.24	1.96	21.49	15.06	2.03	20.85	14.75	2.11	19.82	14.27	2.28	16.95	12.96	2.34
64.4	77.0	27.19	17.95	1.37	25.03	16.93	1.65	24.00	16.46	1.82	22.94	15.98	1.97	22.53	15.79	2.03	21.86	15.50	2.13	20.83	15.04	2.28	18.07	13.87	2.33
66.9	80.1	27.71	18.71	1.38	25.52	17.72	1.65	24.49	17.26	1.82	23.43	16.80	1.97	23.02	16.62	2.03	22.40	16.36	2.13	21.37	15.92	2.30	18.62	14.79	2.32
71.6	86.0	29.26	17.94	1.39	27.08	17.06	1.67	26.05	16.66	1.83	24.98	16.25	1.98	24.58	16.09	2.05	23.94	15.85	2.15	22.94	15.48	2.31	20.29	14.51	2.30
75.2	89.6	30.29	17.40	1.40	28.11	16.60	1.68	27.08	16.23	1.84	26.05	15.86	2.00	25.60	15.71	2.07	24.98	15.49	2.15	23.94	15.13	2.32	21.40	14.28	2.28

Heating: 208-230V 60Hz  
Temp.: Celsius/TC,PI; kW

Indoor Temperature		Outdoor temperature [°C WB]															
		-15.0			-10.0			-5.0			0.0			6.1			18.0
°C	°F	TC	PI	TC	PI	TC	PI	TC	PI	TC	PI	TC	PI	TC	PI	TC	PI
15.0	20.0	3.26	1.19	3.56	1.26	4.40	1.30	5.04	1.70	6.97	1.94	7.58	2.00	9.48	2.48		
21.1	30.0	3.08	1.23	3.38	1.29	4.21	1.33	4.85	1.75	6.74	1.98	7.35	2.04	8.66	2.42		
22.0	25.0	2.99	1.25	3.31	1.31	4.13	1.35	4.77	1.76	6.64	1.99	7.26	2.06	8.33	2.39		
24.0	29.1	2.91	1.25	3.23	1.33	4.05	1.36	4.68	1.78	6.55	2.01	7.17	2.08	8.01	2.36		
25.0	28.6	2.86	1.27	3.19	1.33	4.02	1.37	4.66	1.79	6.51	2.02	7.11	2.09	7.84	2.35		
27.0	27.9	2.79	1.27	3.12	1.35	3.93	1.38	4.57	1.80	6.41	2.04	7.02	2.10	7.51	2.32		

Heating: 208-230V 60Hz  
Temp.: Fahrenheit/TC:kBtu/h/PI; kW

Indoor Temperature		Outdoor temperature [°F WB]																		
		5.0			14.0			23.0			32.0			43.0			50.0			64.4
°F	°C	TC	PI	TC	PI	TC	PI	TC	PI	TC	PI	TC	PI	TC	PI	TC	PI			
59.0	11.13	1.19	1.21	1.26	1.50	1.30	1.71	2.37	1.94	25.87	2.00	32.36	2.48							
70.0	10.50	1.23	1.15	1.29	1.43	1.33	1.65	1.75	23.00	1.98	25.09	2.04	29.56	2.42						
71.6	10.19	1.25	1.18	1.31	1.41	1.35	1.62	1.76	22.67	1.99	24.77	2.06	28.44	2.39						
75.2	9.91	1.25	1.03	1.33	1.36	1.36	1.59	1.78	22.36	2.01	24.45	2.08	27.32	2.36						
77.0	9.77	1.27	1.07	1.33	1.37	1.37	1.59	1.79	22.21	2.02	24.27	2.09	26.76	2.35						
80.6	9.51	1.27	1.05	1.35	1.34	1.38	1.56	1.80	21.88	2.04	23.97	2.10	25.64	2.32						

Symbols:  
AFR Air Flow rate (m<sup>3</sup>/min)  
BPF Bypass factor  
EWB Entering Wet Bulb (°C) / (°F)  
EDB Entering Dry Bulb (°C) / (°F)  
TC Total Capacity (kW) / (kBtu/h)  
SHC Sensible Heat Capacity (kW) / (kBtu/h)  
PI Power Input (kW)

NOTES:  
1) Shows nominal (rated) capacities and power input.  
2) TC, SHC and PI must be calculated by interpolation using the figures in the above table.  
3) Capacities are based on the following conditions:  
Corresponding refrigerant piping length: 25ft  
Level difference: 0ft

### Capacity correction factor by the length of refrigerant piping

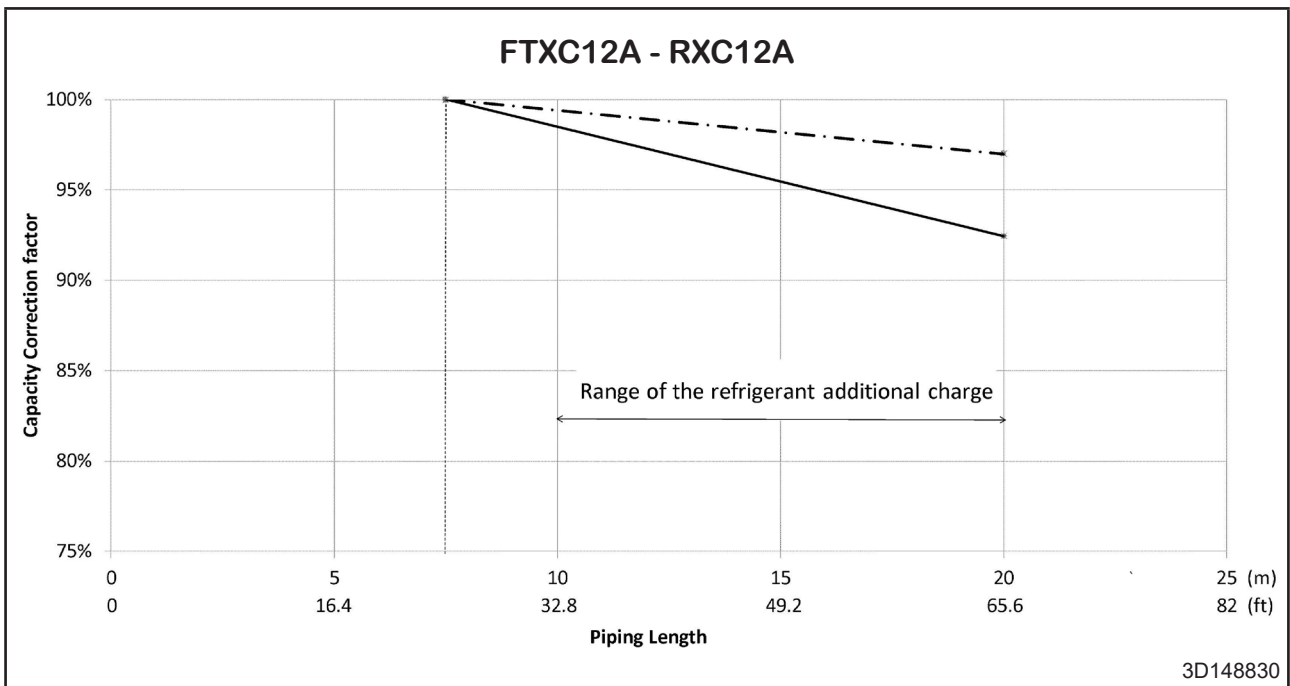
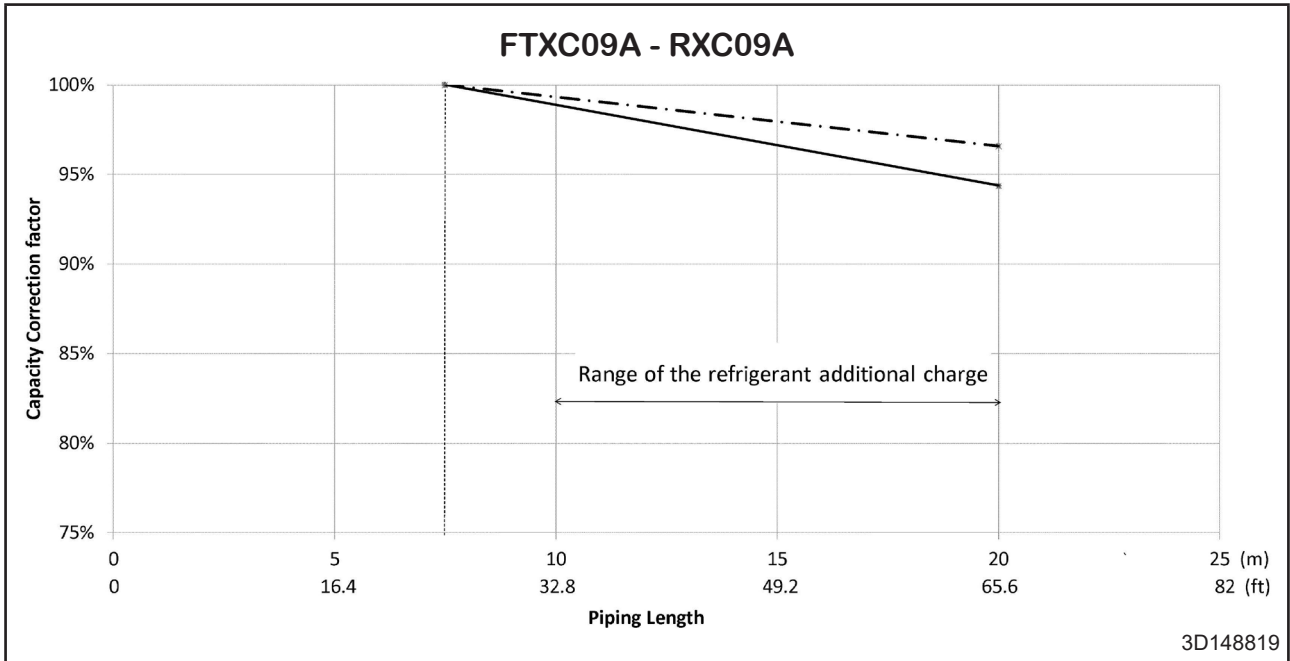

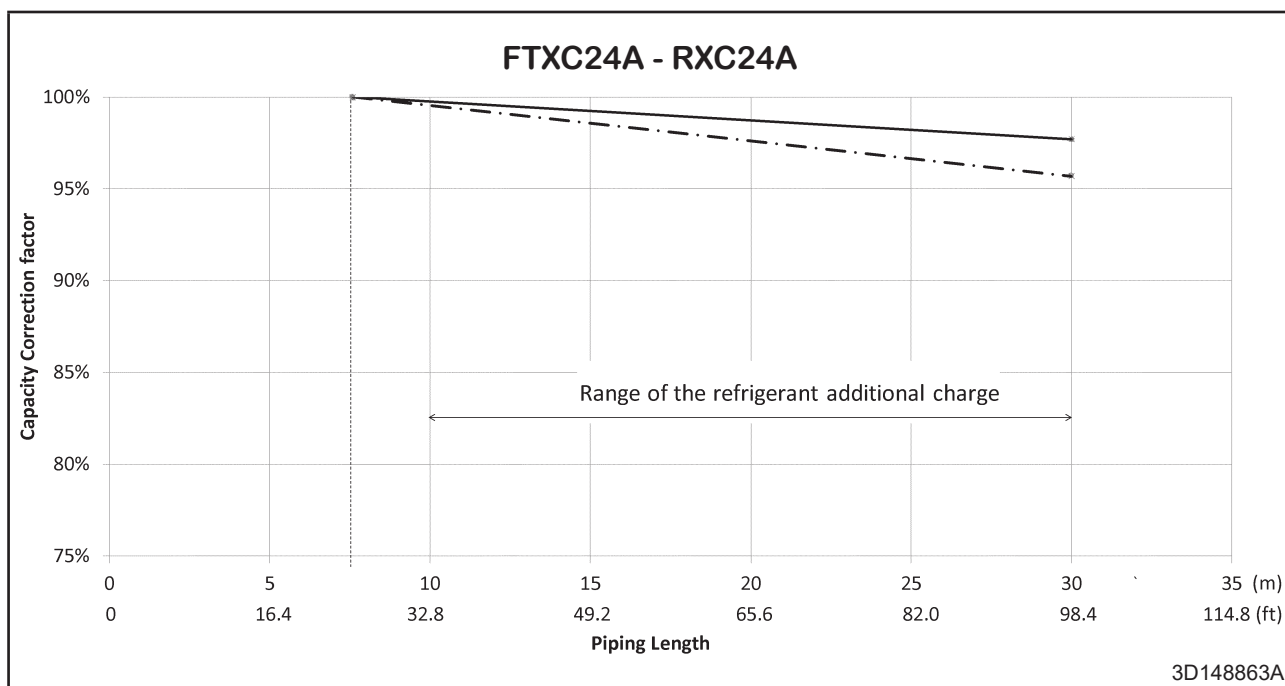
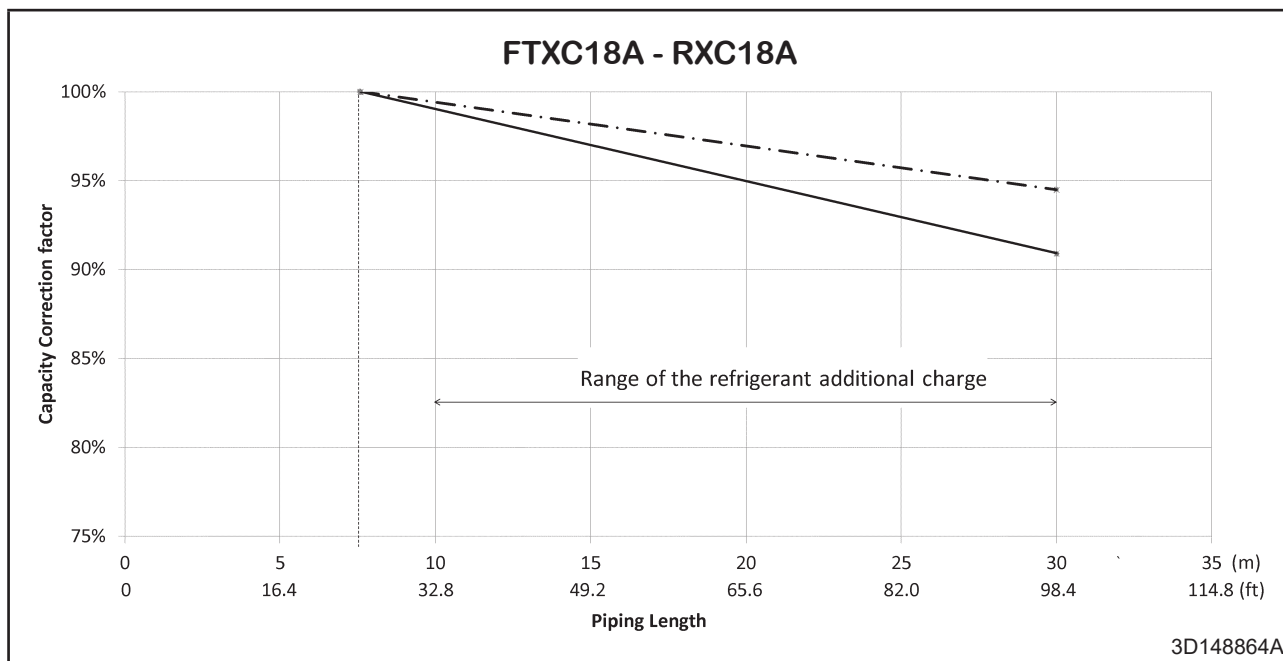

**Notes:**

- 1.----- represents the capacity correction factor for the capacity when additional refrigerant of the proper quantity is charged.
- 2.The correction ratio remains the same whether the outdoor unit is to be installed above or below the unit.
- 3.Calculation method for capacity  
Capacity = capacity obtained from engineering data x capacity correction factor
- 4.The actual unit piping length shall not exceed the maximum piping length shown on the table.

# Operation Limit

Model : RXB-B

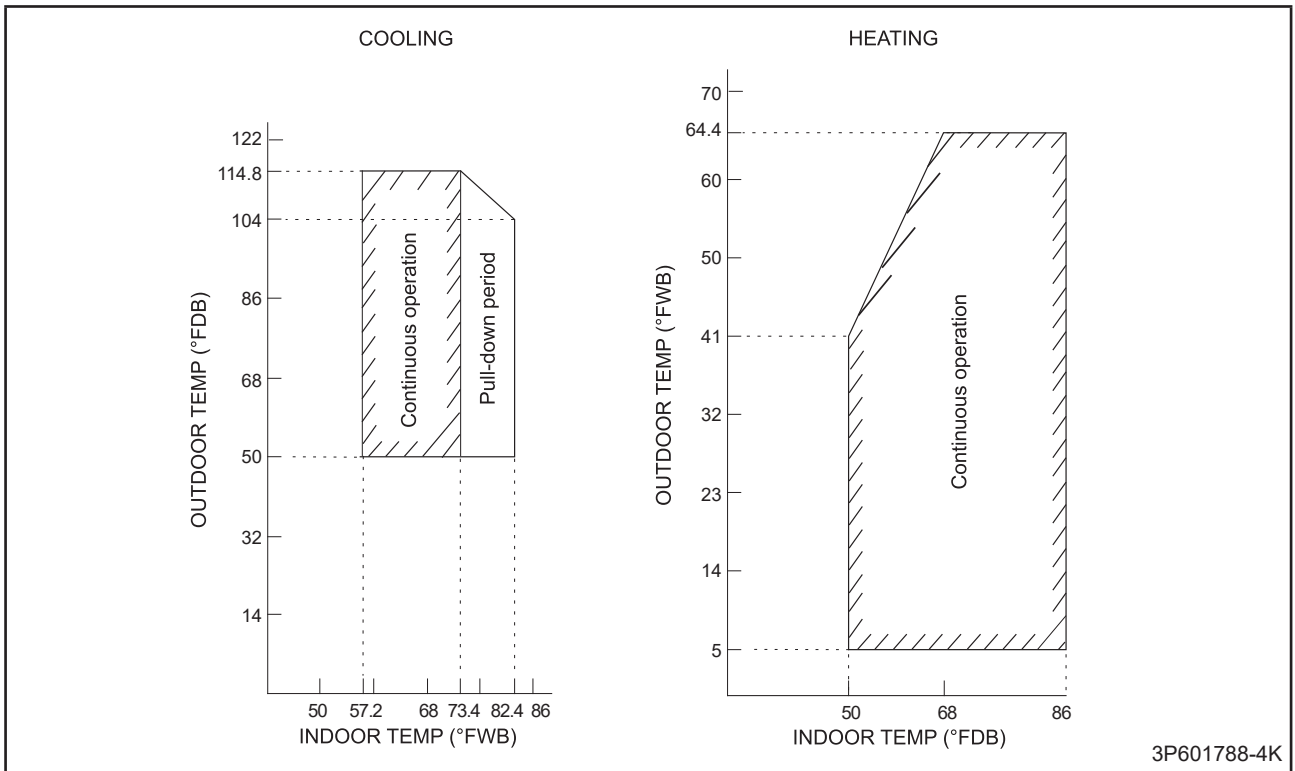

3P601788-4K

# Sound Level

## Measuring Location

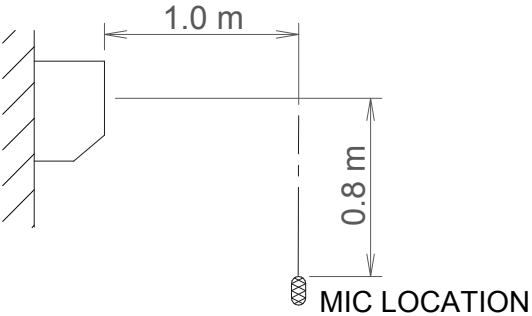
Model	Measuring Location
FTXC09A FTXC12A FTXC18A FTXC24A	 <p>The diagram illustrates the measuring location for sound level measurement. A device is shown on the left, and a microphone (MIC LOCATION) is positioned 1.0 m horizontally and 0.8 m vertically from the device's center.</p>

### Notes:

1. Operation sound is measured in an anechoic chamber.

### Sound Pressure Level

Model	Speed	1/1 Octave A-weighted Sound Pressure Level (dB, ref 20µPa)								Overall (dBA)	Noise Criteria
		63Hz	125Hz	250Hz	500Hz	1kHz	2kHz	4kHz	8kHz		
FTXC09A (Cooling)	High	54	43	41	39	39	35	26	15	43	38
	Med	45	35	36	33	32	26	17	12	36	31
	Low	37	28	30	27	25	19	12	10	29	23
	Quiet	25	19	20	16	13	10	8	9	19	0

### NC Curve

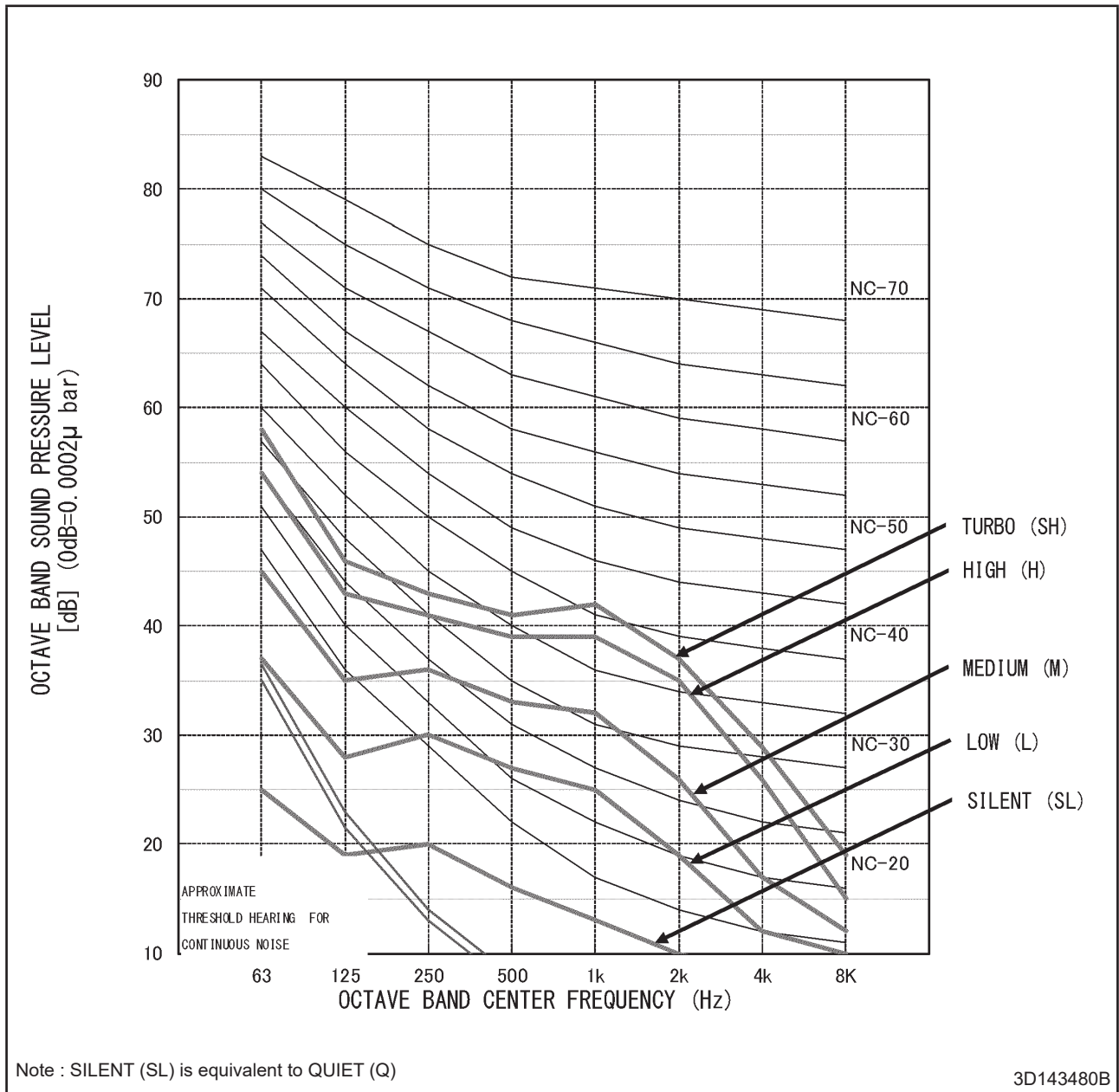

### Sound Pressure Level

Model	Speed	1/1 Octave A-weighted Sound Pressure Level (dB, ref 20μPa)								Overall (dBA)	Noise Criteria
		63Hz	125Hz	250Hz	500Hz	1kHz	2kHz	4kHz	8kHz		
FTXC09A (Heating)	High	49	37	39	37	40	34	26	15	42	39
	Med	36	29	37	33	31	24	13	11	35	30
	Low	30	23	32	26	24	16	12	10	29	22
	Quiet	23	21	29	23	19	11	11	9	25	17

### NC Curve

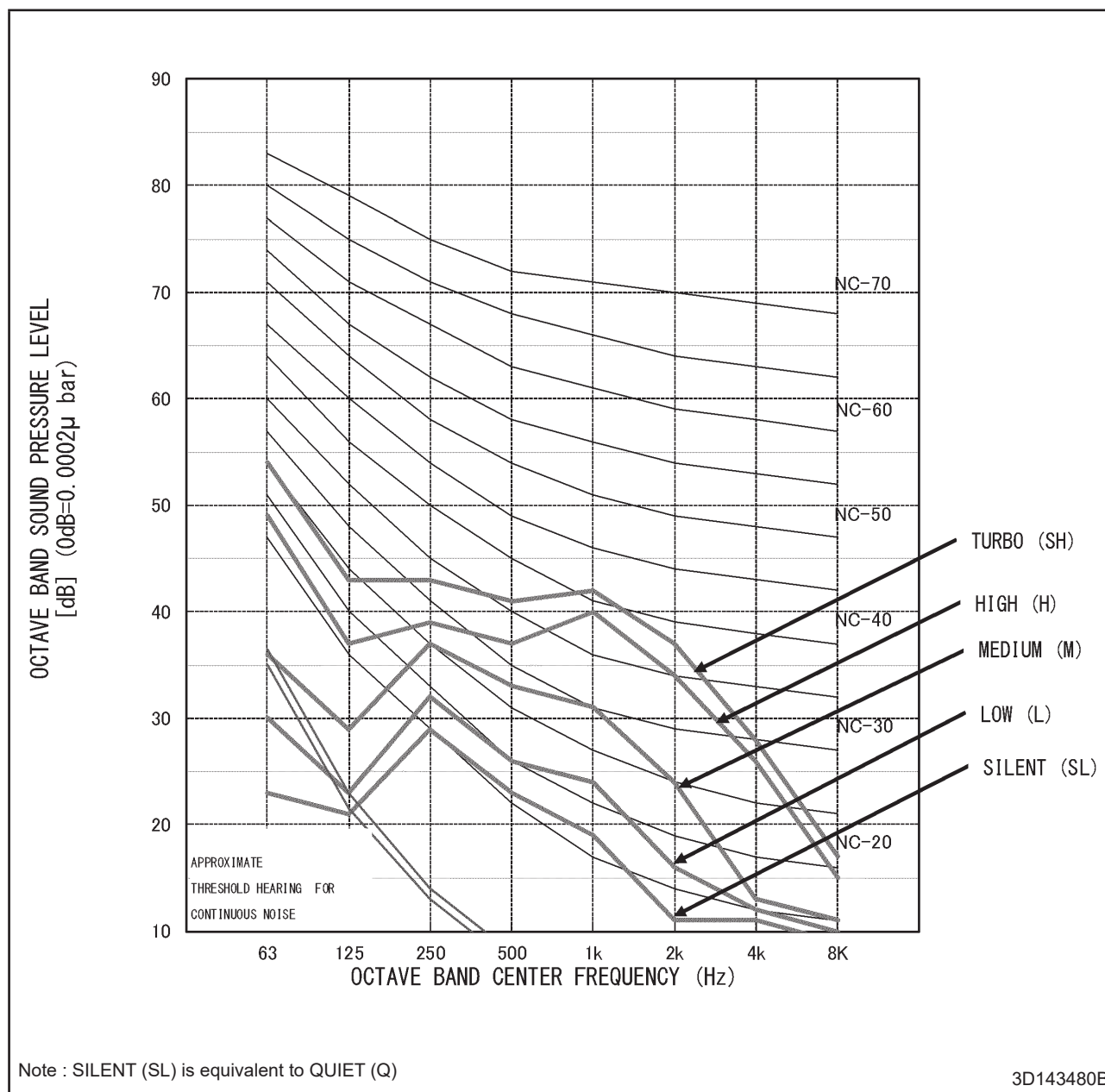

### Sound Pressure Level

Model	Speed	1/1 Octave A-weighted Sound Pressure Level (dB, ref 20µPa)								Overall (dBA)	Noise Criteria
		63Hz	125Hz	250Hz	500Hz	1kHz	2kHz	4kHz	8kHz		
FTXC12A (Cooling)	High	44	36	42	40	43	37	29	19	45	42
	Med	34	29	35	33	34	28	19	12	37	33
	Low	26	24	30	29	27	21	14	11	31	25
	Quiet	17	19	18	16	13	11	10	9	19	N/A

### NC Curve

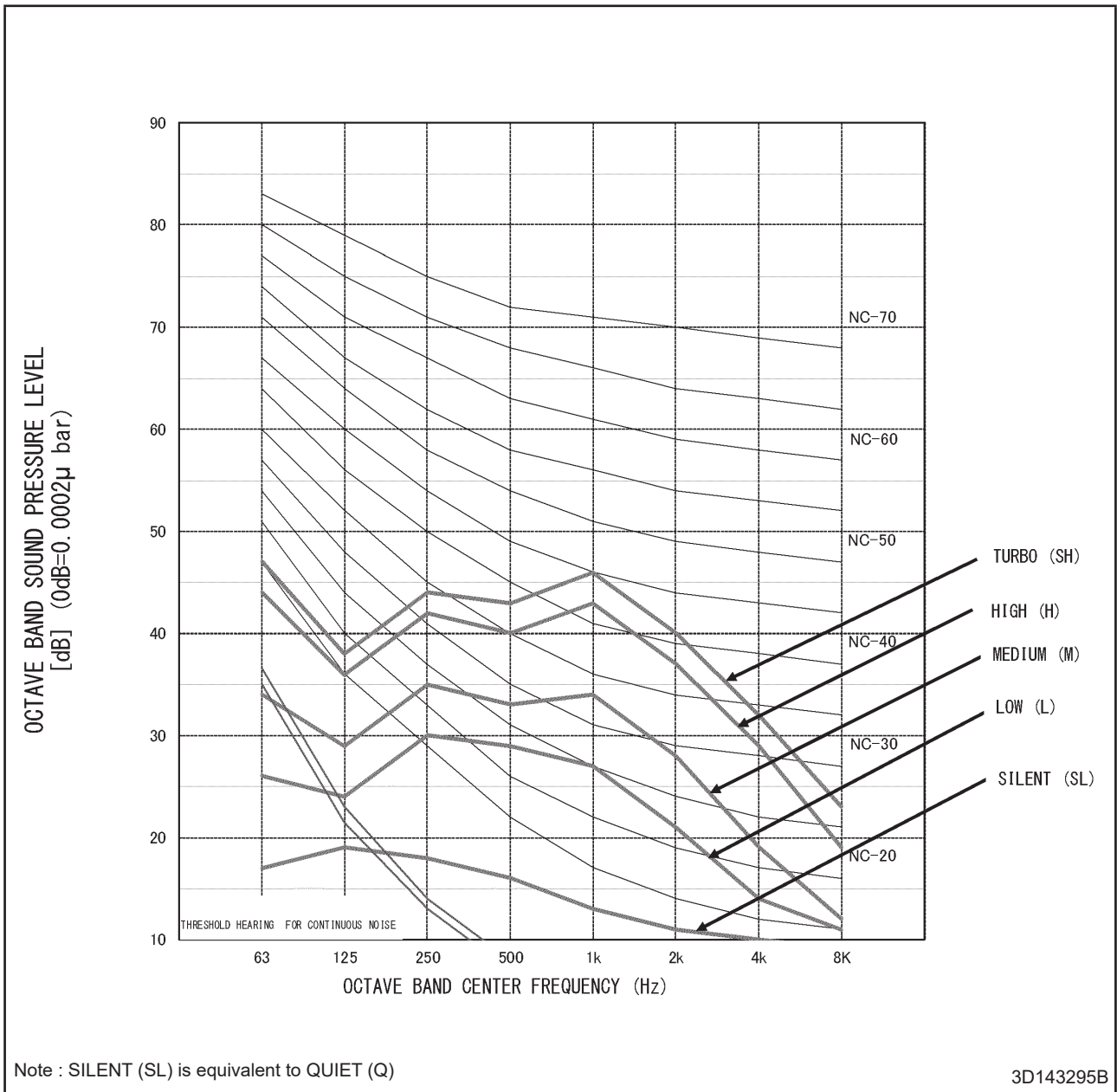

### Sound Pressure Level

Model	Speed	1/1 Octave A-weighted Sound Pressure Level (dB, ref 20μPa)								Overall (dBA)	Noise Criteria
		63Hz	125Hz	250Hz	500Hz	1kHz	2kHz	4kHz	8kHz		
FTXC12A (Heating)	High	47	36	40	38	41	34	23	12	43	40
	Med	39	29	37	33	32	24	14	11	36	31
	Low	29	25	32	28	26	17	12	11	30	24
	Quiet	28	24	29	25	20	12	10	10	26	19

### NC Curve

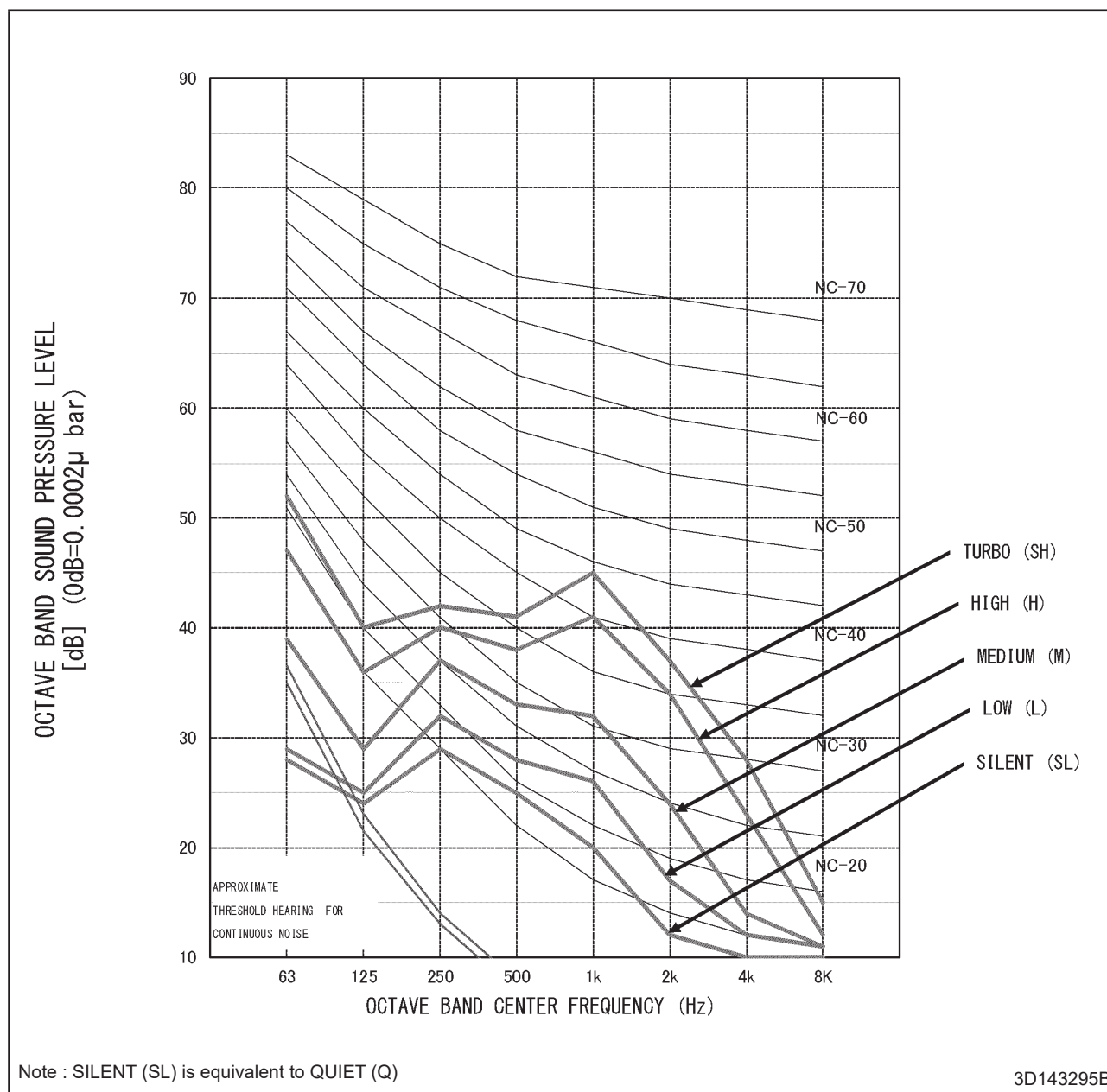

### Sound Pressure Level

Model	Speed	1/1 Octave A-weighted Sound Pressure Level (dB, ref 20µPa)								Overall (dBA)	Noise Criteria
		63Hz	125Hz	250Hz	500Hz	1kHz	2kHz	4kHz	8kHz		
FTXC18A (Cooling)	High	51	41	45	43	44	42	35	25	48	43
	Med	41	35	41	39	39	37	29	18	43	38
	Low	34	30	37	34	33	30	21	13	37	32
	Quiet	30	28	34	31	28	23	13	10	33	26

### NC Curve

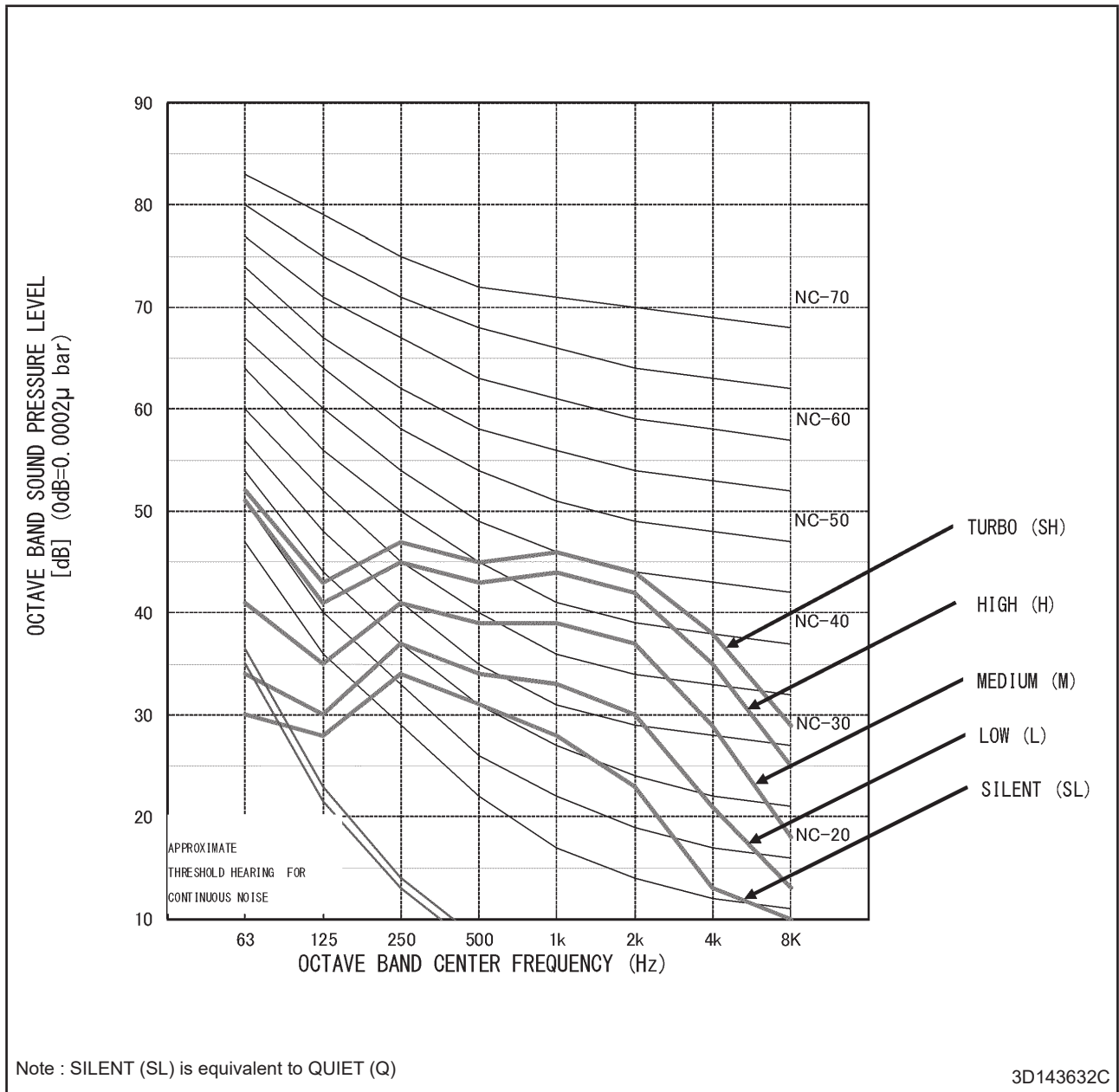



### Sound Pressure Level

Model	Speed	1/1 Octave A-weighted Sound Pressure Level (dB, ref 20μPa)								Overall (dBA)	Noise Criteria
		63Hz	125Hz	250Hz	500Hz	1kHz	2kHz	4kHz	8kHz		
FTXC18A (Heating)	High	52	40	43	42	42	39	30	16	46	41
	Med	45	35	39	38	37	34	24	12	41	36
	Low	38	31	38	34	32	25	14	11	36	31
	Quiet	37	29	35	31	29	23	12	10	33	28

### NC Curve

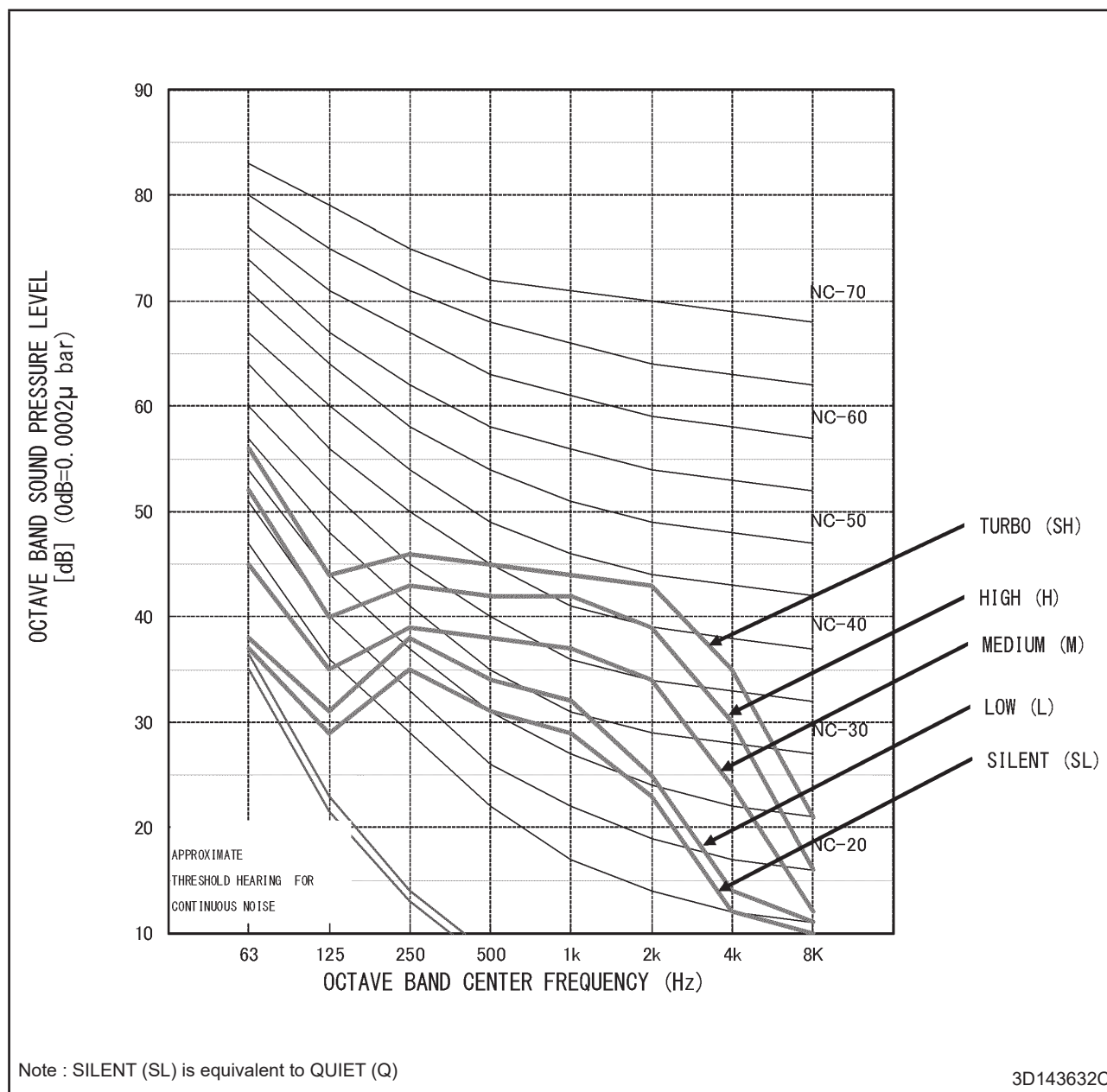

### Sound Pressure Level

Model	Speed	1/1 Octave A-weighted Sound Pressure Level (dB, ref 20μPa)								Overall (dBA)	Noise Criteria
		63Hz	125Hz	250Hz	500Hz	1kHz	2kHz	4kHz	8kHz		
FTXC24A (Cooling)	High	51	43	48	46	47	44	39	27	51	46
	Med	42	36	42	40	40	37	29	18	44	39
	Low	35	31	38	35	34	31	21	13	38	33
	Quiet	31	28	35	32	29	24	14	11	34	28

### NC Curve

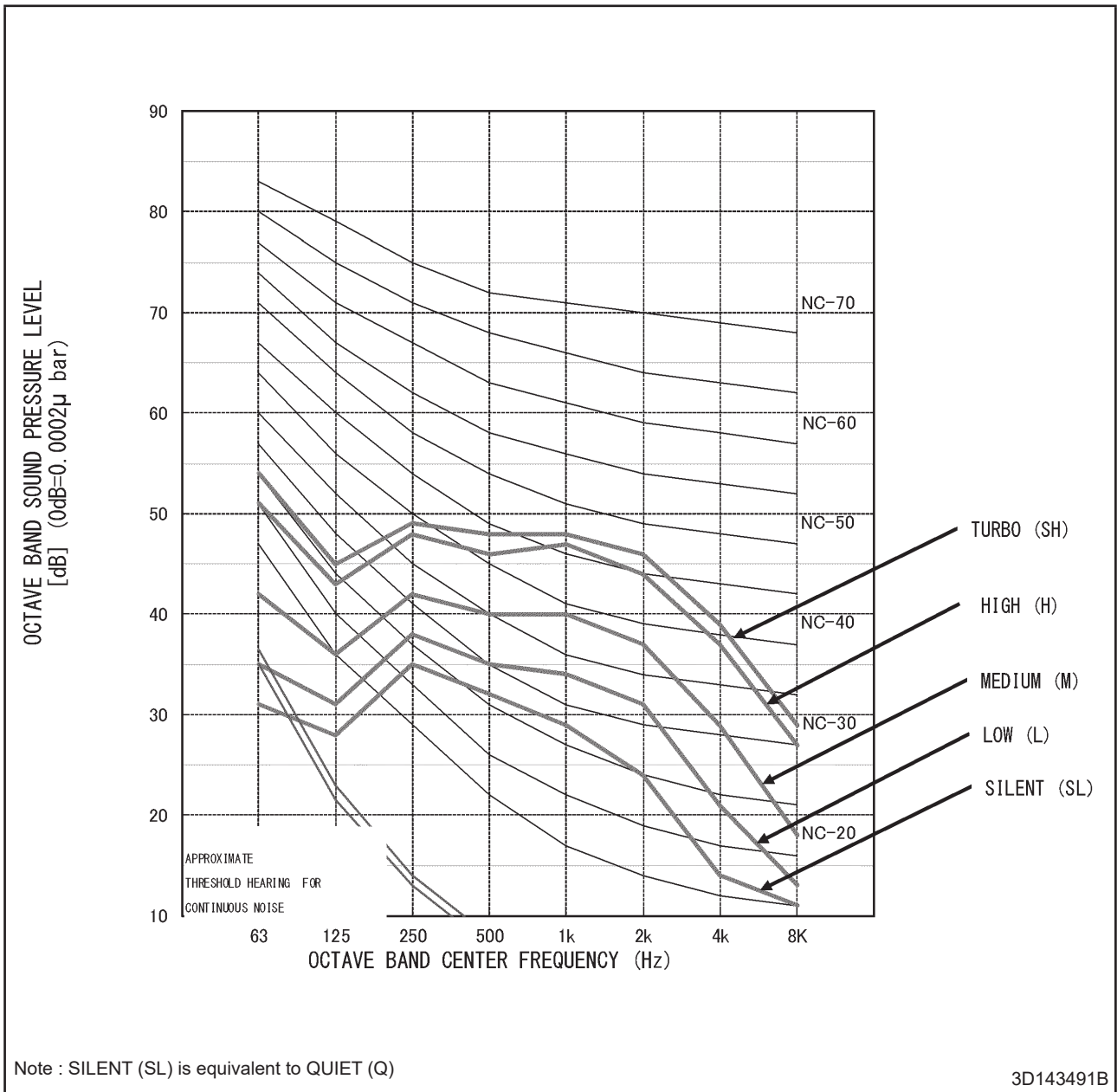

### Sound Pressure Level

Model	Speed	1/1 Octave A-weighted Sound Pressure Level (dB, ref 20μPa)								Overall (dBA)	Noise Criteria
		63Hz	125Hz	250Hz	500Hz	1kHz	2kHz	4kHz	8kHz		
FTXC24A (Heating)	High	55	43	45	44	44	41	33	18	48	43
	Med	46	36	40	38	39	35	25	13	42	38
	Low	38	31	38	35	32	26	15	11	37	31
	Quiet	37	29	36	32	30	23	12	10	34	29

### NC Curve

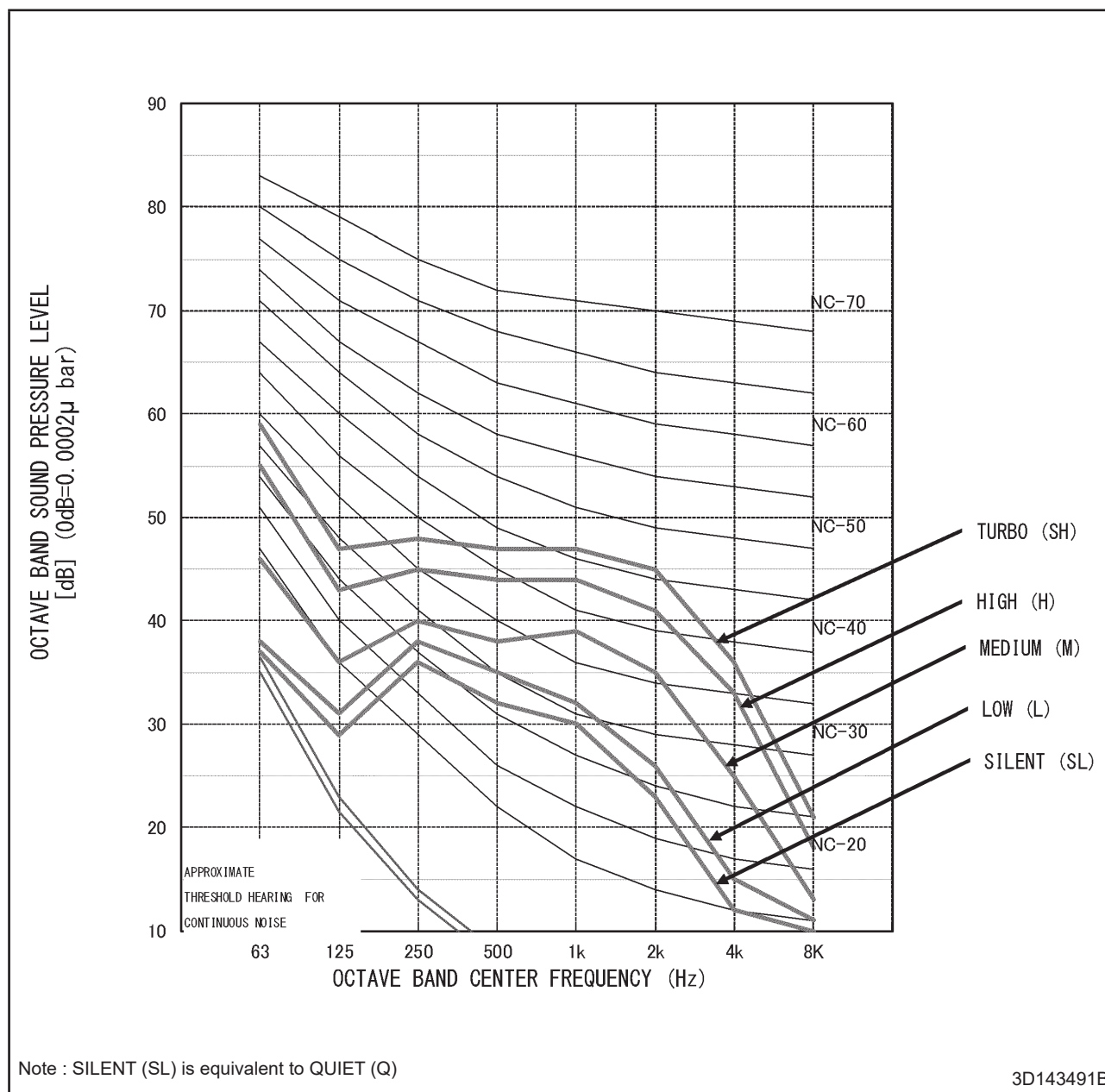

# Electric Characteristic

Unit Combination		Power Supply				COMP		OFM		IFM	
Indoor Unit	Outdoor Unit	Hz-Volts	Voltage Range	MCA	MOP	RHz	A	kW	MOC	kW	MOC
FTXC09A	RXC09A	60Hz-208V	MAX. 60Hz 253V MIN. 60Hz 187V	9.30	15	54	6.05	0.026	0.61	0.022	0.35
		60Hz-230V									
FTXC12A	RXC12A	60Hz-208V	MAX. 60Hz 253V MIN. 60Hz 187V	9.36	15	74	5.99	0.026	0.61	0.022	0.40
		60Hz-230V									
FTXC18A	RXC18A	60Hz-208V	MAX. 60Hz 253V MIN. 60Hz 187V	16.34	20	75	9.09	0.055	1.30	0.039	0.55
		60Hz-230V									
FTXC24A	RXC24A	60Hz-208V	MAX. 60Hz 253V MIN. 60Hz 187V	16.34	20	83	9.09	0.055	1.30	0.039	0.55
		60Hz-230V									

**Symbols:**

- MCA : Minimum Circuit Amps (A)
- MOP : Maximum Overcurrent Protection (A)
- COMP : Compressor
- RHz : Rated Operating Frequency (Hz)
- A : Compressor Input Current (A)
- OFM : Outdoor Fan Motor
- IFM : Indoor Fan Motor
- kW : Fan Motor Rated Output (kW)
- MOC : Maximum Operating Current (A)

**Notes:**

1. RHz is the max frequency that comes in cooling operation and heating operation.
2. MOC is the max current that comes in cooling operation and heating operation.
3. Maximum allowable voltage that is unbalance between phases is 2%.
4. Select wire size based on the larger value of MCA.
5. Use circuit breaker instead of fuse

3D148140B

# Accessories List

	Optional Accessories	Model Number
<b>Indoor Unit</b>	Wired Controller	BRC51D61
	Daikin One+ Smart Thermostat	DTST-ONE-ADA-A
	DKN Residential Cloud Wi-Fi Adaptor	AZAI6WSCDKB
<b>Outdoor Unit</b>	Air Directional Change Grille (Class 09/12)	KPW937F4
	Air Directional Change Grille (Class 18/24)	KPW063B4E
	Drain Pan Heater (Class 09/12)	FTDBHMS, KEH067A41E
	Drain Pan Heater (Class 18/24)	KEH063A4EA
	Outdoor Unit Protection Net Grille (Class 09/12)	KKG067A41
	Outdoor Unit Protection Net Grille (Class 18/24)	-

