

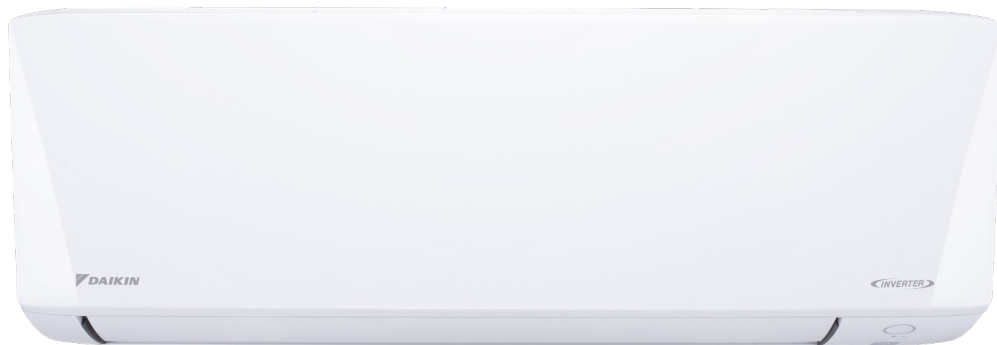

ENGINEERING DATA

**Inverter Split Unit Air Conditioner
Wall Mounted
Heatpump [60Hz]**

FTXB-B Series



R410A

ED5WM15R-NA23V2
Supersede : ED5WM15R-NA23V1

Table of Contents

Introduction	1
Model Name and Power Supply	1
Nomenclature	2
Functions	3
Specifications	4
Dimensions	8
Wiring Diagrams	10
Piping Diagrams	12
Capacity Tables	16
Capacity Tables	16
Capacity Correction Factor	20
Operation Limit	22
Sound Level	23
Measuring Location	23
Sound Pressure Level & NC Curve	24
Electric Characteristic	32
Accessories List	33

Introduction

Model Name and Power Supply

Indoor Unit	Outdoor Unit	Power Supply
FTXB09BXVJU	RXB09BXVJU	1Phase, 208/230V, 60Hz
FTXB12BXVJU	RXB12BXVJU	
FTXB18BXVJU	RXB18BXVJU	
FTXB24BXVJU	RXB24BXVJU	

Nomenclature

Indoor Unit

Definition	Description
Unit Category	F : Air-Cooled Split Indoor Unit
Product Type	T : Wall Mounted
System	X : Inverter, Heatpump
Classification	B : Designed Model
Capacity Indication*	09 : 9,000 Btu/h
Major Design Category	B : A Series
Factory Origin	X : Malaysia
Power Supply	VJ : 208/230V / 1Phase / 60Hz
Country	U : United States

Outdoor Unit

Definition	Description
Unit Category	R : Air-Cooled Split Outdoor Unit
System	X : Inverter, Heatpump
Classification	B : Designed Model
Capacity Indication*	09 : 9,000 Btu/h
Major Design Category	B : B Series
Factory Origin	X : Malaysia
Power Supply	VJ : 208/230V / 1Phase / 60Hz
Country	U : United States

Remark:

*Capacity value under Nomenclature is an indication.
Please refer to Specifications for exact capacity value.

Functions

Category	Functions	FTXB09/12B RXB09/12B	FTXB18/24B RXB18/24B
Basic Function	Inverter	●	●
	Operation Limit for Cooling (°CDB)(O/D)	10 - 46	10 - 46
	Operation Limit for Cooling (°FDB)(O/D)	50 - 114.8	50 - 114.8
	Operation Limit for Heating (°CWB)(O/D)	-15 - 18	-15 - 18
	Operation Limit for Heating (°FWB)(O/D)	5 - 64.4	5 - 64.4
Compressor	Scroll Compressor	-	-
	Swing Compressor	●	●
	Rotary Compressor	-	-
Comfortable Airflow	Power-airflow Flap	●	-
	Power-airflow Dual Flaps	-	●
	Power-airflow Diffuser	-	-
	Wide Angle Louvers	●	●
	Vertical Auto-Swing (Up and Down)	●	●
	Horizontal Auto-Swing (Right and Left)	-	-
	3D Airflow	-	-
Comfort Control	Breeze Airflow	-	-
	Auto Fan Speed	●	●
	Indoor Unit Quiet Operation	●	●
	Intelligent Eye Operation	-	-
Operation	Automatic Defrosting	●	●
	Automatic Operation	●	●
	Programme Dry Function	●	●
Lifestyle Convenience	Fan Only	●	●
	Powerful Operation (Non Inverter)	-	-
	Inverter Powerful Operation	●	●
	Energy Saving Function	●	●
	Sleep Mode	●	●
	Indoor Unit ON/OFF Button	●	●
	R/C with Backlight	●	●
Health & Clean	Signal Receiving Sign (R/C)	●	●
	Set Temperature Display (R/C)	●	●
	Saranet Filter	-	-
	Anti-virus Filter / Gin-ION Filter	-	-
	Catechin Filter / Green Tea Filter	●	●
	Titanium Apatite Air-Purifying Filter	●	●
	PM 2.5 Filter	-	-
	Streamer	-	-
Timer	Plasma	-	-
	Wipe Clean Flat Panel	●	●
	Weekly Timer Operation (Wired R/C)	-	-
	24-hour ON/OFF Timer (R/C)	●	●
Worry Free (Reliability & Durability)	Countdown ON/OFF Timer (R/C)	-	-
	Auto Restart (after Power Failure)	●	●
	Self-diagnosis	●	●
Flexibility	Anti-corrosion Treatment of Outdoor Heat Exchanger	●	●
	Pre-charged Piping Length	32-13/16 ft	32-13/16 ft
Remote Control	Either Side Drain (Right or Left)	●	●
	WiFi Connectivity	●*	●*
	BAG Connectivity	●*	●*
Remote Controller	DIII-NET Connectivity	-	-
	Wireless	BRC52B63	BRC52B63
	Wired	BRC51D61	BRC51D61

Note: ● : Available

- : Not Available

●* : Optional (Refer to DAMA Spare Part team for more details on optional items.)

Specifications

MODEL	INDOOR UNIT		FTXB09B	
	OUTDOOR UNIT		RXB09B	
		Cooling		Heating
Rated Capacity (Min. ~ Max.)	kW	2.57 (1.30 - 3.00)		2.75 (1.30 - 3.80)
	Btu/h	8800 (4400 - 10200)		9400 (4400 - 13000)
Moisture Removal	gal/h	0.09		
Rated Running Current	A	3.82		3.70
Rated Power Consumption	W	800		774
EER2	Btu/h/W	11.0		N/A
SEER2		18.0		N/A
COP	W/W	N/A		3.56
HSPF2		N/A		9.0
Power Factor (Rated)	N/A			
Piping Connections	Liquid	inch (mm)	1/4" (6.35)	
	Gas	inch (mm)	3/8" (9.52)	
Refrigerant	Type	R410A		
	Charge	lbs (kg)	1.54 (0.7)	
Max. Interunit Piping Length	ft (m)	65-5/8 (20)		
Max. Interunit Height Difference	ft (m)	32-13/16 (10)		
Chargeless	ft (m)	32-13/16 (10)		
Amount of Additional Charge of Refrigerant	oz/ft (g/m)	0.21 (20)		
Drawing No.	3D143694C			
INDOOR UNIT		FTXB09B		
Front Panel Colour	WHITE			
Airflow Rate	Turbo	CFM	466	
	High	CFM	431	402
	Medium	CFM	322	
	Low	CFM	249	
	Quiet	CFM	142	219
Sound Pressure Level (H/M/L/Q)	dB(A)	43/36/29/19		42/35/29/25
Fan	Type	CROSS FLOW		
	Drive	DIRECT		
	Speed	3 STEPS, QUIET, AUTO, TURBO		
Fan Motor	Type	DIRECT CURRENT		
	Motor Output	W	22	
	Running Current (Rated)	A	0.10	
	Power Consumption (Rated)	W	29	
Air Direction Control	UP, DOWN, LEFT, RIGHT			
Air Filter	CATECHIN			
Dimensions (H x W x D)	inch (mm)	11-1/3 x 30-5/16 x 9-3/16 (288 x 770 x 234)		
Packaged Dimensions (H x W x D)	inch (mm)	13-7/8 x 32-3/4 x 12-3/8 (350 x 830 x 314)		
Weight	lbs (kg)	20.3 (9.2)		
Gross Weight	lbs (kg)	24.7 (11.2)		
Condensate Drain Size	inch (mm)	5/8 (16)		
Document No.	3D143550B			
OUTDOOR UNIT		RXB09B		
Casing Colour	IVORY WHITE			
Airflow Rate	High	CFM	1083	1103
Sound Pressure Level		dB(A)	46	48
Fan	Type	PROPELLER		
	Drive	DIRECT		
Fan Motor	Type	DIRECT CURRENT		
	Index of protection (IP)	24		
	Insulation Grade	E		
	Running Current (Rated)	A	0.60	
	Power Consumption (Rated)	W	32	
	Motor Output	W	26	
Compressor	Poles	8		
	Type	HERMETIC SWING		
	Model	1YC23AUXDA		
	Oil type	DAPHNE FVC50K		
	Oil amount	oz (cm³)	12.4 (375)	
Heat Exchanger Type	FIN TUBE			
Dimensions (H x W x D)	inch (mm)	21-11/16 x 26-1/2 x 11-3/16 (550 x 675 x 284)		
Packaged Dimensions (H x W x D)	inch (mm)	24-1/64 x 31-3/8 x 15-1/8 (610 x 801 x 384)		
Weight	lbs (kg)	55 (25)		
Gross Weight	lbs (kg)	62 (28)		
Document No.	3D143595A			

1) ALL UNITS ARE BEING TESTED ACCORDING TO AHRI 210/240 STANDARD.
 2) ALL SPECIFICATIONS ARE SUBJECT TO CHANGE BY THE MANUFACTURER WITHOUT PRIOR NOTICE.

COOLING		HEATING	
INDOOR: 80°FDB (26.7°CDB) / 67°FWB (19.4°CWB)		INDOOR: 70°FDB (21.1°CDB)	
OUTDOOR: 95°FDB (35°CDB)		OUTDOOR: 47°FDB (8.3°CDB) / 43°FWB(6.1°CWB)	

MODEL	INDOOR UNIT		FTXB12B	
	OUTDOOR UNIT		RXB12B	
		Cooling		Heating
Rated Capacity (Min. ~ Max.)	kW	3.22 (1.30 - 3.90)		3.31 (1.30 - 4.81)
	Btu/h	11000 (4400 - 13300)		11300 (4400 - 16400)
Moisture Removal	gal/h	0.18		
Rated Running Current	A	3.22		4.55
Rated Power Consumption	W	1294		1004
EER2	Btu/h/W	8.5		N/A
SEER2		18.0		N/A
COP	W/W	N/A		3.30
HSPF2		N/A		9.0
Power Factor (Rated)	N/A			
Piping Connections	Liquid	inch (mm)	1/4" (6.35)	
	Gas	inch (mm)	3/8" (9.52)	
Refrigerant	Type	R410A		
	Charge	lbs (kg)	2.09 (0.95)	
Max. Interunit Piping Length	ft (m)	65-5/8 (20)		
Max. Interunit Height Difference	ft (m)	32-13/16 (10)		
Chargeless	ft (m)	32-13/16 (10)		
Amount of Additional Charge of Refrigerant	oz/ft (g/m)	0.21 (20)		
Drawing No.	3D143694C			
INDOOR UNIT		FTXB12B		
Front Panel Colour	WHITE			
Airflow Rate	Turbo	CFM	473	
	High	CFM	436	412
	Medium	CFM	316	
	Low	CFM	247	
	Quiet	CFM	132	210
Sound Pressure Level (H/M/L/Q)	dBA	45/37/31/19		43/36/30/26
Fan	Type	CROSS FLOW		
	Drive	DIRECT		
	Speed	3 STEPS, QUIET, AUTO, TURBO		
Fan Motor	Type	DIRECT CURRENT		
	Motor Output	W	22	
	Running Current (Rated)	A	0.10	
	Power Consumption (Rated)	W	29	
Air Direction Control	UP, DOWN, LEFT, RIGHT			
Air Filter	CATECHIN			
Dimensions (H x W x D)	inch (mm)	11-1/3 x 30-5/16 x 9-3/16 (288 x 770 x 234)		
Packaged Dimensions (H x W x D)	inch (mm)	13-7/8 x 32-3/4 x 12-3/8 (350 x 830 x 314)		
Weight	lbs (kg)	21.4 (9.7)		
Gross Weight	lbs (kg)	25.8 (11.7)		
Condensate Drain Size	inch (mm)	5/8 (16)		
Document No.	3D143550B			
OUTDOOR UNIT		RXB12B		
Casing Colour	IVORY WHITE			
Airflow Rate	High	CFM	1051	966
Sound Pressure Level	dBA	48		
Fan	Type	PROPELLER		
	Drive	DIRECT		
Fan Motor	Type	DIRECT CURRENT		
	Index of protection (IP)	24		
	Insulation Grade	E		
	Running Current (Rated)	A	0.61	
	Power Consumption (Rated)	W	46	
	Motor Output	W	26	
Compressor	Poles	8		
	Type	HERMETIC SWING		
	Model	1YC23AUXDA		
	Oil type	DAPHNE FVC50K		
	Oil amount	oz (cm ³)	12.4 (375)	
Heat Exchanger Type	FIN TUBE			
Dimensions (H x W x D)	inch (mm)	21-11/16 x 26-1/2 x 11-3/16 (550 x 675 x 284)		
Packaged Dimensions (H x W x D)	inch (mm)	24-1/64 x 31-3/8 x 15-1/8 (610 x 801 x 384)		
Weight	lbs (kg)	62 (28)		
Gross Weight	lbs (kg)	68 (31)		
Document No.	3D143595A			

1) ALL UNITS ARE BEING TESTED ACCORDING TO AHRI 210/240 STANDARD.
 2) ALL SPECIFICATIONS ARE SUBJECTED TO CHANGE BY THE MANUFACTURER WITHOUT PRIOR NOTICE.

COOLING		HEATING	
INDOOR: 80°FDB (26.7°CDB) / 67°FWB (19.4°CWB)		INDOOR: 70°FDB (21.1°CDB)	
OUTDOOR: 95°FDB (35°CDB)		OUTDOOR: 47°FDB (8.3°CDB) / 43°FWB (6.1°CWB)	

Specifications

MODEL	INDOOR UNIT		FTXB18B	
	OUTDOOR UNIT		RXB18B	
			Cooling	Heating
Rated Capacity (Min. ~ Max.)	kW		5.27 (1.96 - 5.86)	5.24 (1.70 - 6.60)
	Btu/h		18000 (6700 - 20000)	17900 (5800 - 22500)
Moisture Removal	gal/h		0.41	
Rated Running Current	A		7.53	6.98
Rated Power Consumption	W		1714	1590
EER2	Btu/h/W		10.5	N/A
SEER2			18.0	N/A
COP	W/W		N/A	3.30
HSPF2			N/A	8.5
Power Factor (Rated)			N/A	
Piping Connections	Liquid	inch (mm)	1/4" (6.35)	
	Gas	inch (mm)	1/2" (12.70)	
Refrigerant	Type		R410A	
	Charge	lbs (kg)	3.20 (1.45)	
Max. Interunit Piping Length	ft (m)		98-1/2 (30)	
Max. Interunit Height Difference	ft (m)		32-13/16 (10)	
Chargeless	ft (m)		32-13/16 (10)	
Amount of Additional Charge of Refrigerant	oz/ft (g/m)		0.21 (20)	
Drawing No.			3D143694C	
INDOOR UNIT		FTXB18B		
Front Panel Colour			WHITE	
Airflow Rate	Turbo	CFM	754	
	High	CFM	716	
	Medium	CFM	605	
	Low	CFM	467	
	Quiet	CFM	395	
Sound Pressure Level (H/M/L/Q)	dBA		48/43/37/33	46/41/36/33
Fan	Type		CROSS FLOW	
	Drive		DIRECT	
	Speed		3 STEPS, QUIET, AUTO, TURBO	
Fan Motor	Type		DIRECT CURRENT	
	Motor Output	W	39	
	Running Current (Rated)	A	0.17	
	Power Consumption (Rated)	W	54	
Air Direction Control			UP, DOWN, LEFT, RIGHT	
Air Filter			CATECHIN	
Dimensions (H x W x D)	inch (mm)		11-11/16 x 39-9/16 x 10-3/4 (297 x 990 x 273)	
Packaged Dimensions (H x W x D)	inch (mm)		14-1/4 x 42-1/4 x 14-1/8 (362 x 1073 x 358)	
Weight	lbs (kg)		31 (14)	
Gross Weight	lbs (kg)		36 (16.5)	
Condensate Drain Size	inch (mm)		5/8 (16)	
Document No.			3D143550B	
OUTDOOR UNIT		RXB18B		
Casing Colour			IVORY WHITE	
Airflow Rate	High	CFM	1987	1952
Sound Pressure Level		dBA	53	
Fan	Type		PROPELLER	
	Drive		DIRECT	
Fan Motor	Type		DIRECT CURRENT	
	Index of protection (IP)		23	
	Insulation Grade		E	
	Running Current (Rated)	A	1.30	
	Power Consumption (Rated)	W	85	
	Motor Output	W	55	
Compressor	Poles		8	
	Type		HERMETIC SWING	
	Model		2Y147AKCX2A	
	Oil type		DAPHNE FVC50K	
	Oil amount	oz (cm ³)	21.5 (650)	
Heat Exchanger Type			FIN TUBE	
Dimensions (H x W x D)	inch (mm)		27-13/32 x 36-5/8 x 13-13/16 (696 x 930 x 351)	
Packaged Dimensions (H x W x D)	inch (mm)		29-7/8 x 42-3/8 x 18-7/8 (760 x 1075 x 480)	
Weight	lbs (kg)		97 (44)	
Gross Weight	lbs (kg)		106 (48)	
Document No.			3D143595A	

1) ALL UNITS ARE BEING TESTED ACCORDING TO AHRI 210/240 STANDARD.
 2) ALL SPECIFICATIONS ARE SUBJECTED TO CHANGE BY THE MANUFACTURER WITHOUT PRIOR NOTICE.

COOLING		HEATING	
INDOOR: 80°FDB (26.7°CDB) / 67°FWB (19.4°CWB)		INDOOR: 70°FDB (21.1°CDB)	
OUTDOOR: 95°FDB (35°CDB)		OUTDOOR: 47°FDB (8.3°CDB) / 43°FWB (6.1°CWB)	

MODEL	INDOOR UNIT		FTXB24B	
	OUTDOOR UNIT		RXB24B	
		Cooling		Heating
Rated Capacity (Min. ~ Max.)	kW	6.21 (2.02 - 6.50)		6.21 (1.70 - 8.00)
	Btu/h	21200 (6900 - 22200)		21200 (5800 - 27300)
Moisture Removal	gal/h	0.66		
Rated Running Current	A	8.87		7.76
Rated Power Consumption	W	2019		1767
EER2	Btu/h/W	10.5		N/A
SEER2		18.0		N/A
COP	W/W	N/A		3.52
HSPF2		N/A		8.5
Power Factor (Rated)	N/A			
Piping Connections	Liquid	inch (mm)	1/4" (6.35)	
	Gas	inch (mm)	5/8" (15.88)	
Refrigerant	Type	R410A		
	Charge	lbs (kg)	3.20 (1.45)	
Max. Interunit Piping Length	ft (m)	98-1/2 (30)		
Max. Interunit Height Difference	ft (m)	32-13/16 (10)		
Chargeless	ft (m)	32-13/16 (10)		
Amount of Additional Charge of Refrigerant	oz/ft (g/m)	0.21 (20)		
Drawing No.	3D143694C			
INDOOR UNIT		FTXB24B		
Front Panel Colour	WHITE			
Airflow Rate	Turbo	CFM	754	
	High	CFM	716	
	Medium	CFM	605	
	Low	CFM	467	
	Quiet	CFM	395	
Sound Pressure Level (H/M/L/Q)	dBA	51/44/38/34		48/42/37/34
Fan	Type	CROSS FLOW		
	Drive	DIRECT		
	Speed	3 STEPS, QUIET, AUTO, TURBO		
Fan Motor	Type	DIRECT CURRENT		
	Motor Output	W	39	
	Running Current (Rated)	A	0.17	
	Power Consumption (Rated)	W	54	
Air Direction Control	UP, DOWN, LEFT, RIGHT			
Air Filter	CATECHIN			
Dimensions (H x W x D)	inch (mm)	11-11/16 x 39-9/16 x 10-3/4 (297 x 990 x 273)		
Packaged Dimensions (H x W x D)	inch (mm)	14-1/4 x 42-1/4 x 14-1/8 (362 x 1073 x 358)		
Weight	lbs (kg)	31 (14)		
Gross Weight	lbs (kg)	36 (16.5)		
Condensate Drain Size	inch (mm)	5/8 (16)		
Document No.	3D143550B			
OUTDOOR UNIT		RXB24B		
Casing Colour	IVORY WHITE			
Airflow Rate	High	CFM	1987	1905
Sound Pressure Level		dBA	53	52
Fan	Type	PROPELLER		
	Drive	DIRECT		
Fan Motor	Type	DIRECT CURRENT		
	Index of protection (IP)	23		
	Insulation Grade	E		
	Running Current (Rated)	A	1.30	
	Power Consumption (Rated)	W	88	
	Motor Output	W	55	
Compressor	Poles	8		
	Type	HERMETIC SWING		
	Model	2Y147AKCX2A		
	Oil type	DAPHNE FVC50K		
	Oil amount	oz (cm ³)	21.5 (650)	
Heat Exchanger Type	FIN TUBE			
Dimensions (H x W x D)	inch (mm)	27-13/32 x 36-5/8 x 13-13/16 (696 x 930 x 351)		
Packaged Dimensions (H x W x D)	inch (mm)	29-7/8 x 42-3/8 x 18-7/8 (760 x 1075 x 480)		
Weight	lbs (kg)	97 (44)		
Gross Weight	lbs (kg)	106 (48)		
Document No.	3D143595A			

1) ALL UNITS ARE BEING TESTED ACCORDING TO AHRI 210/240 STANDARD.
 2) ALL SPECIFICATIONS ARE SUBJECTED TO CHANGE BY THE MANUFACTURER WITHOUT PRIOR NOTICE.

COOLING		HEATING	
INDOOR: 80°FDB (26.7°CDB) / 67°FWB (19.4°CWB)		INDOOR: 70°FDB (21.1°CDB)	
OUTDOOR: 95°FDB (35°CDB)		OUTDOOR: 47°FDB (8.3°CDB) / 43°FWB (6.1°CWB)	

Dimensions

Indoor Unit

Model : FTXB09/12B

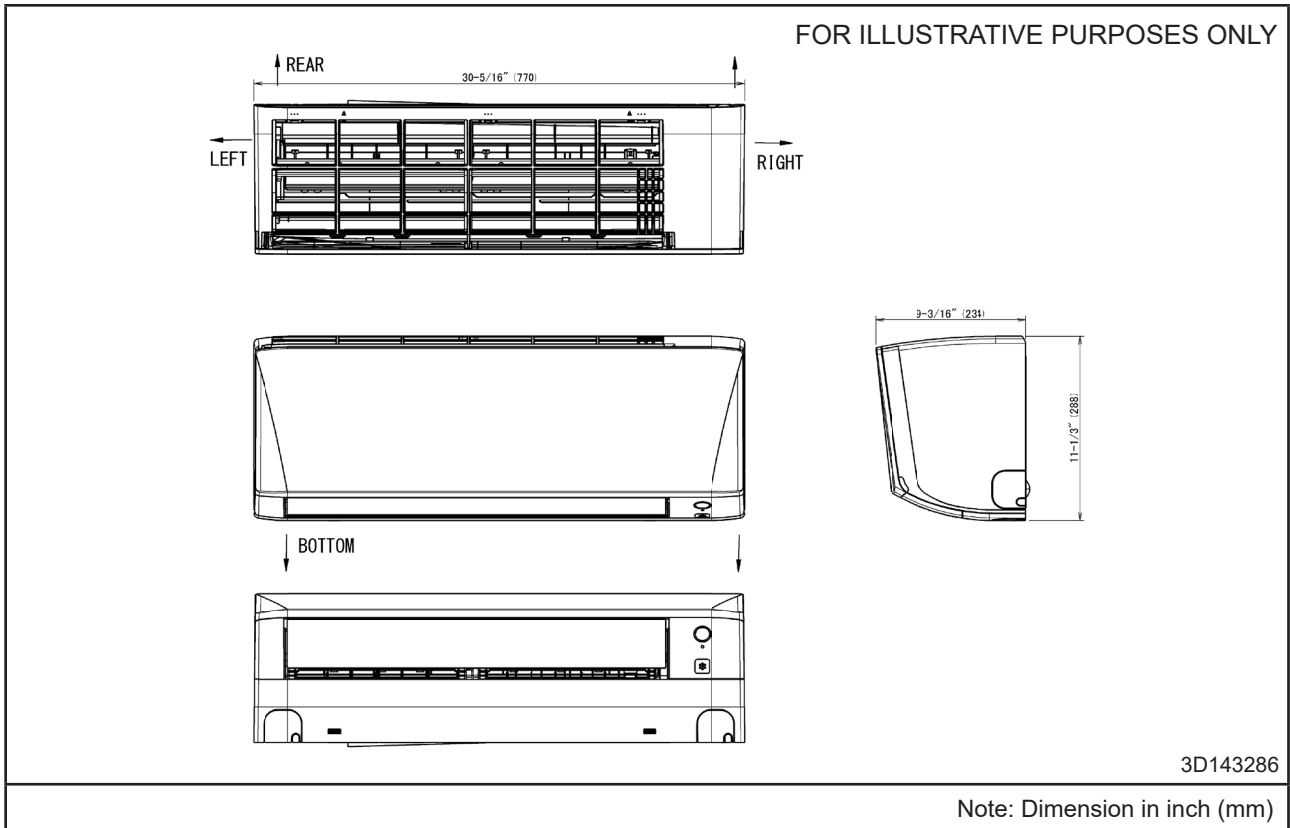

Model : FTXB18/24B

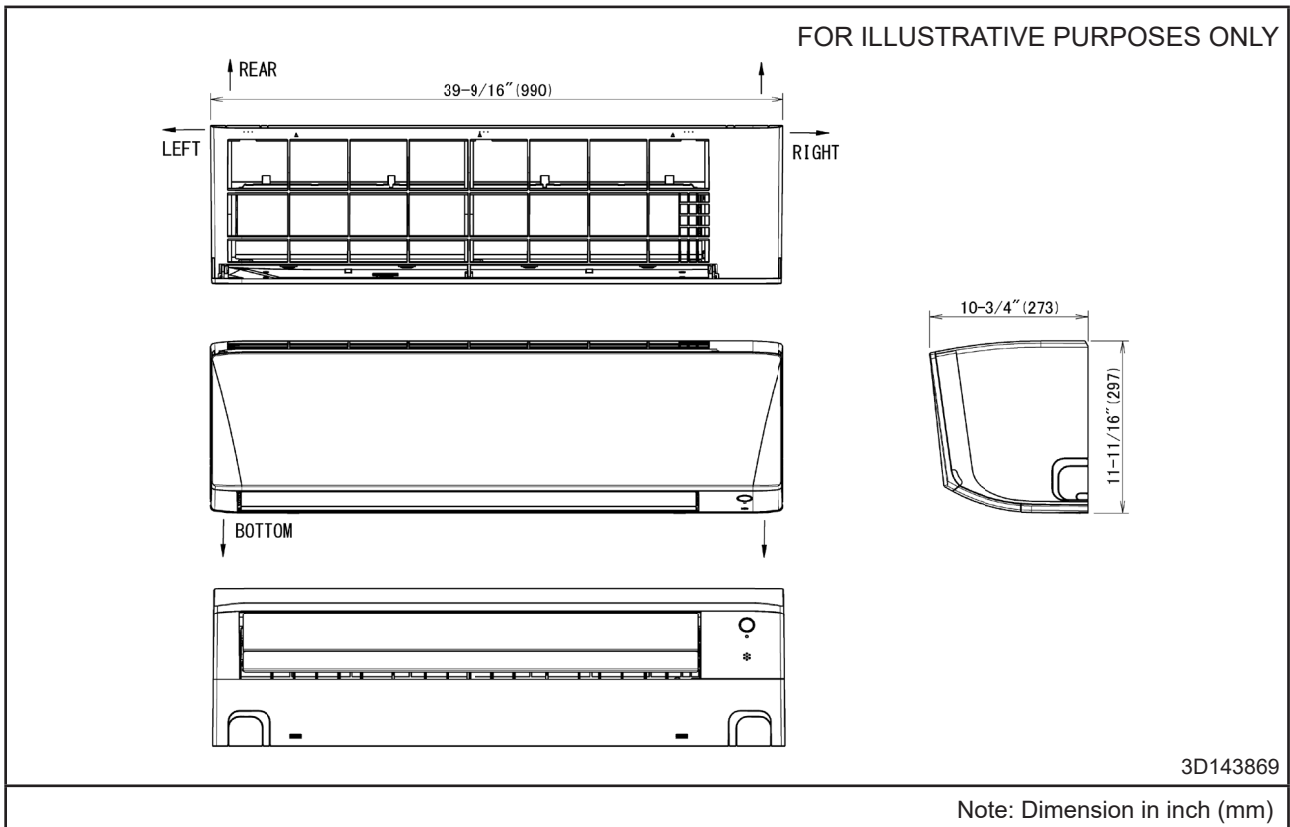

Outdoor Unit

Model : RXB09/12B

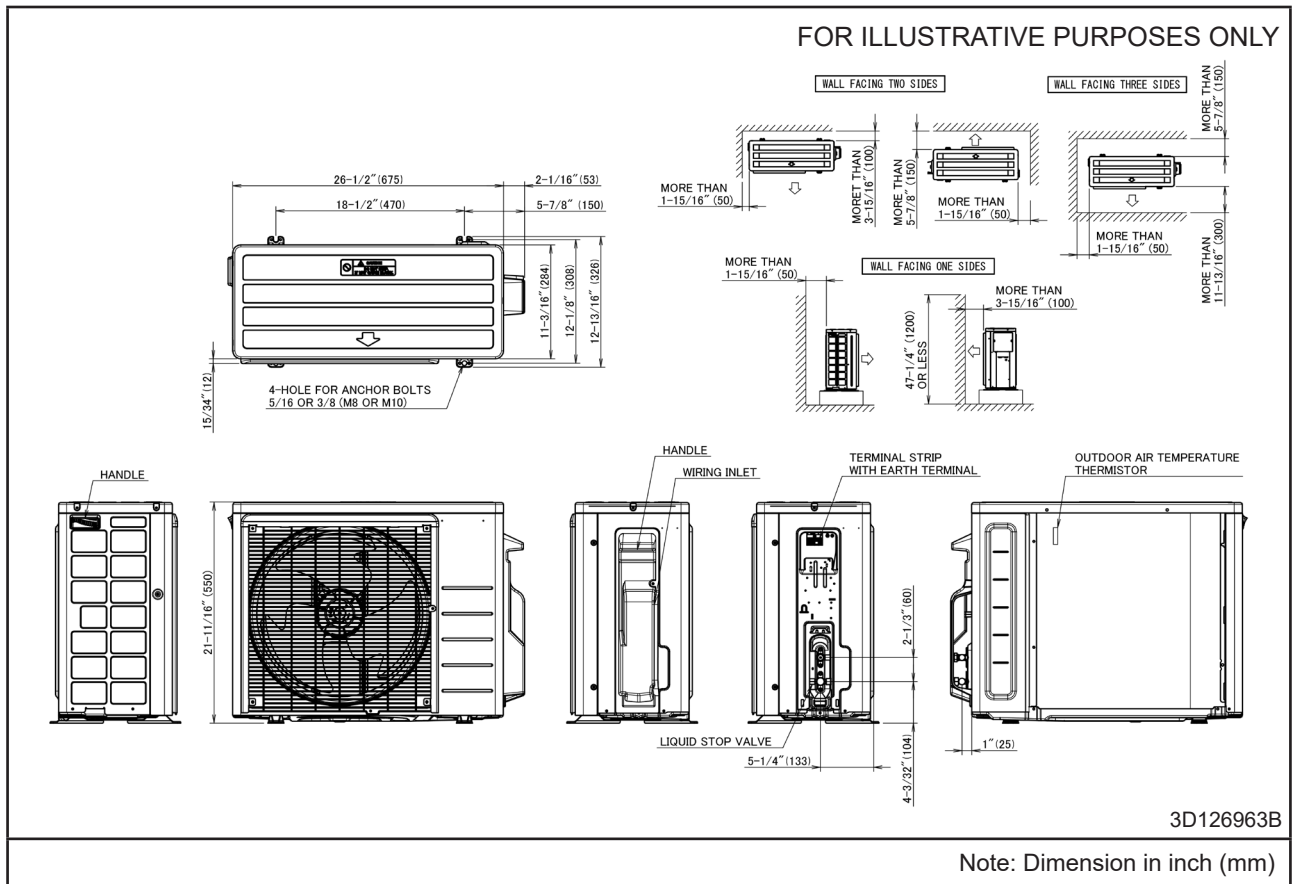

Model : RXB18/24B

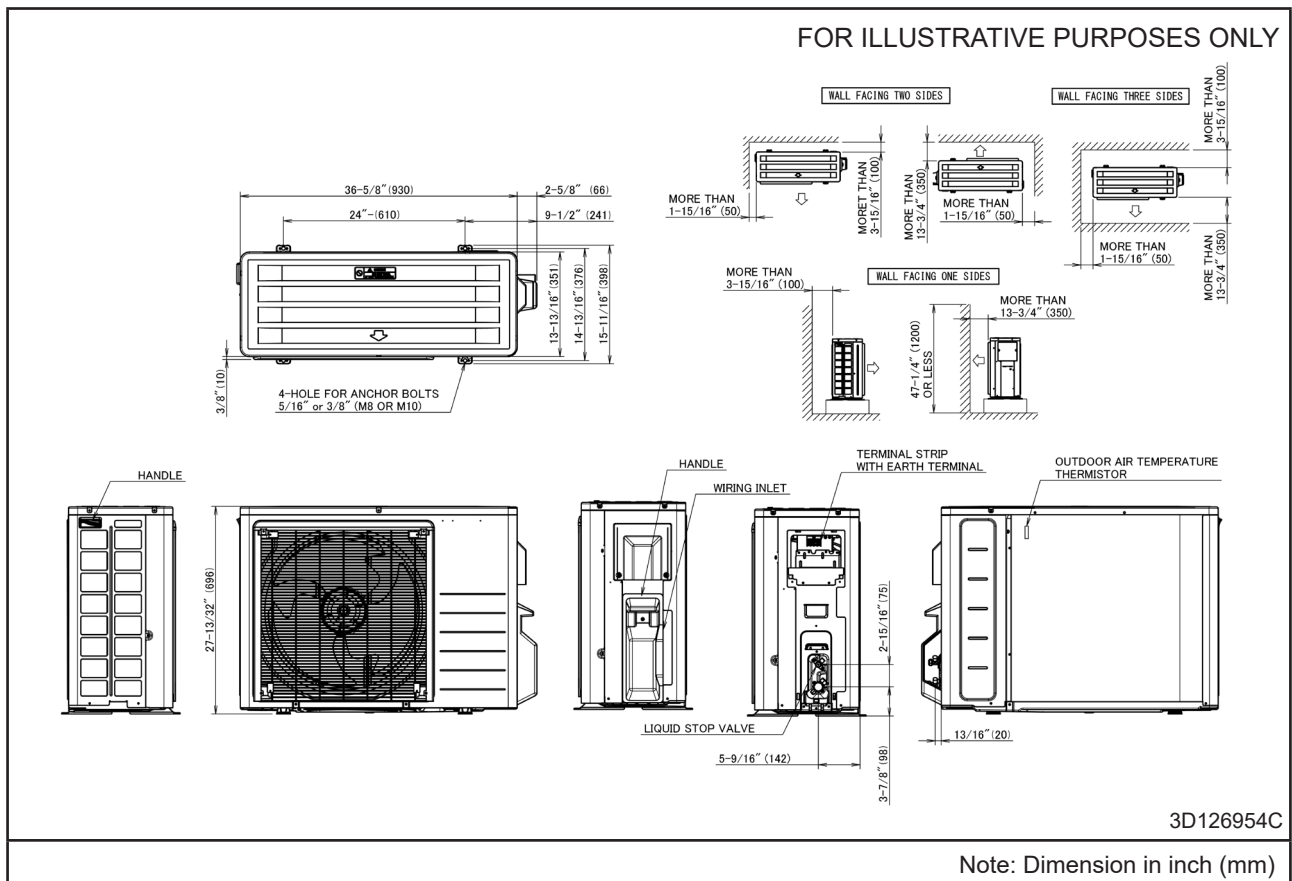

Wiring Diagrams

Indoor Unit

Model : FTXB-B

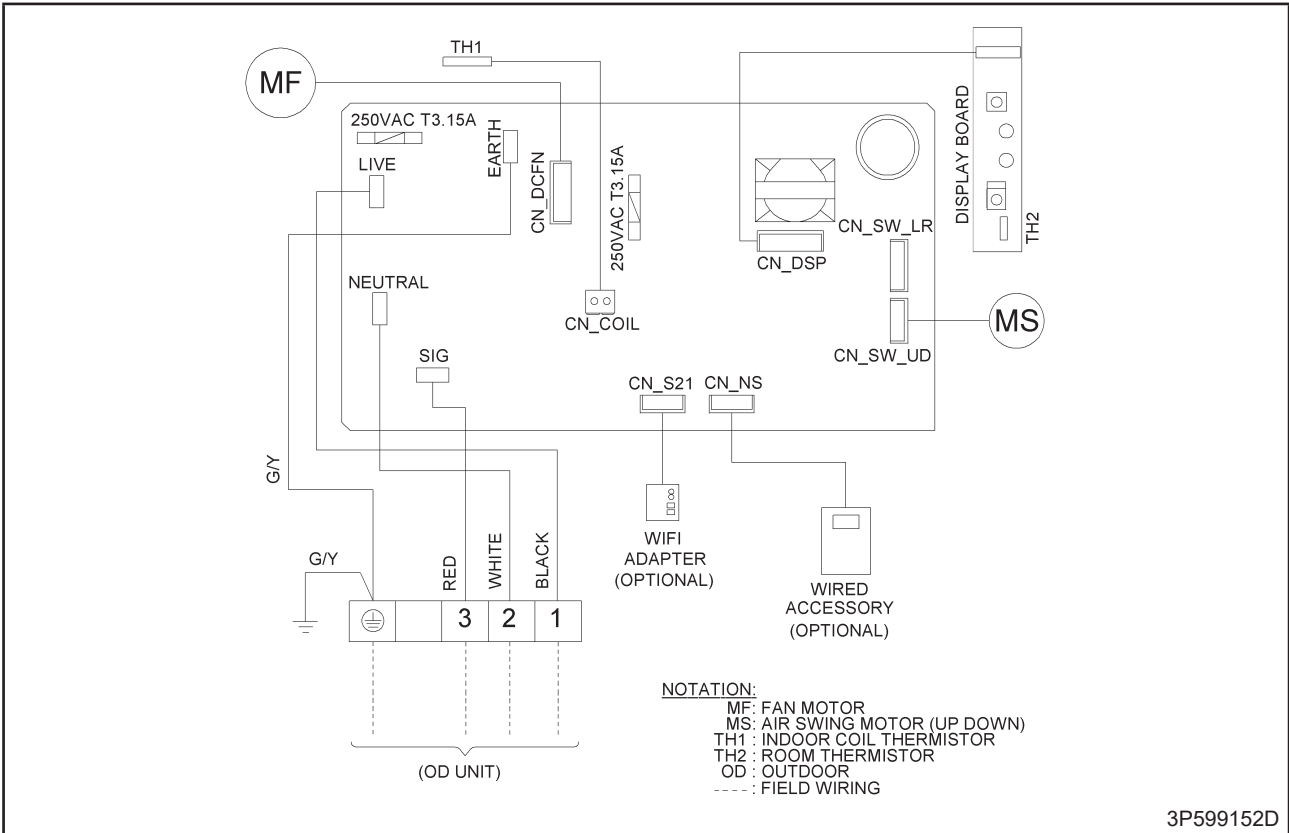

Outdoor Unit

Model : RXB09/12B

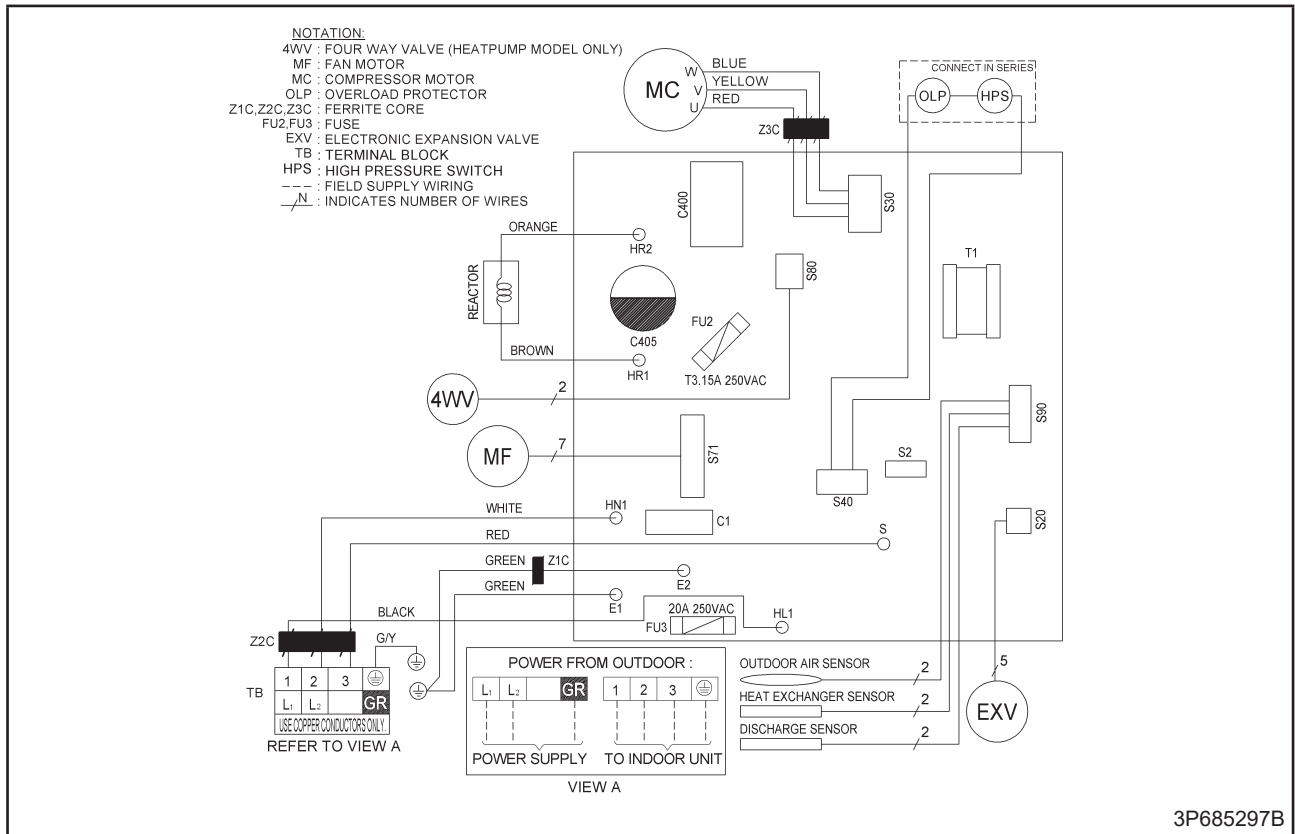

Model : RXB18/24B

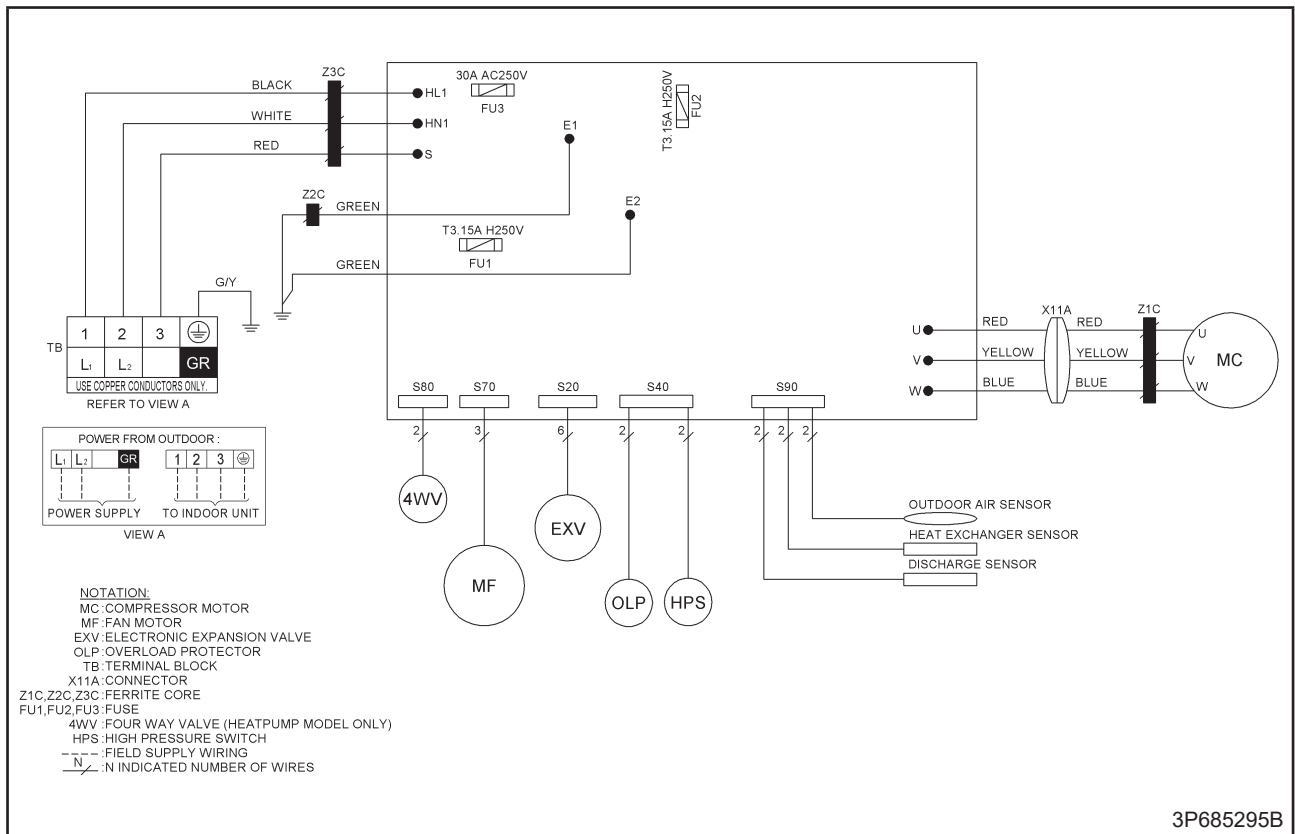

Piping Diagrams

Indoor Unit

Model : FTXB09B

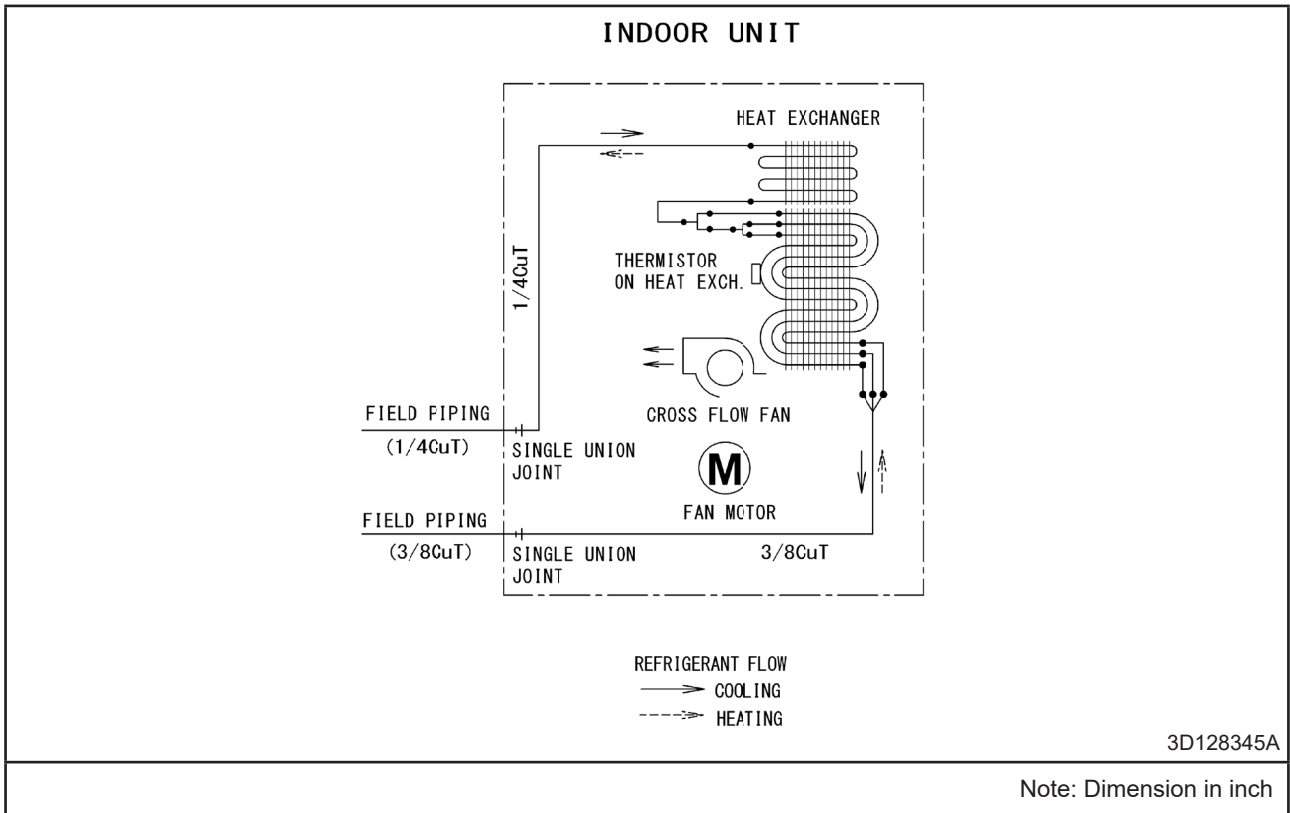

Model : FTXB12B

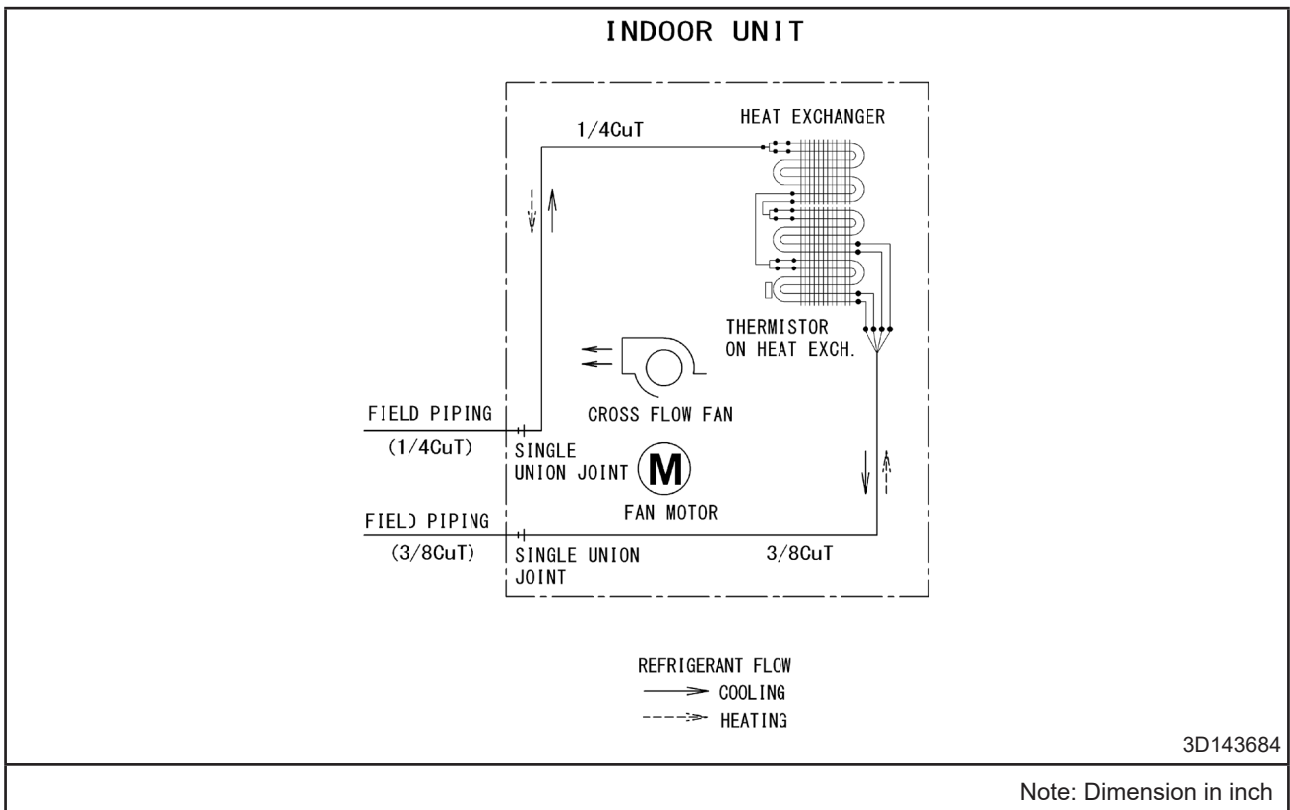

Model : FTXB18B

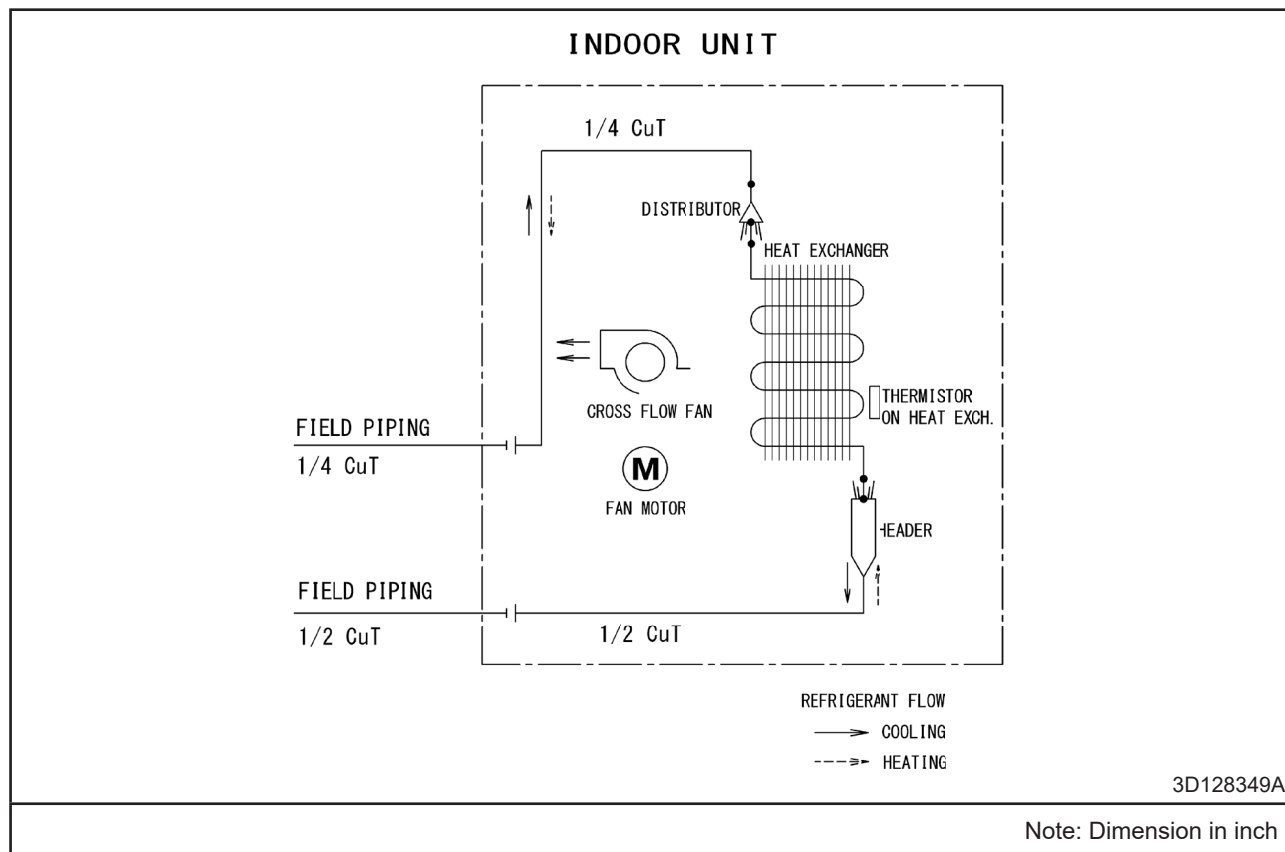

Model : FTXB24B

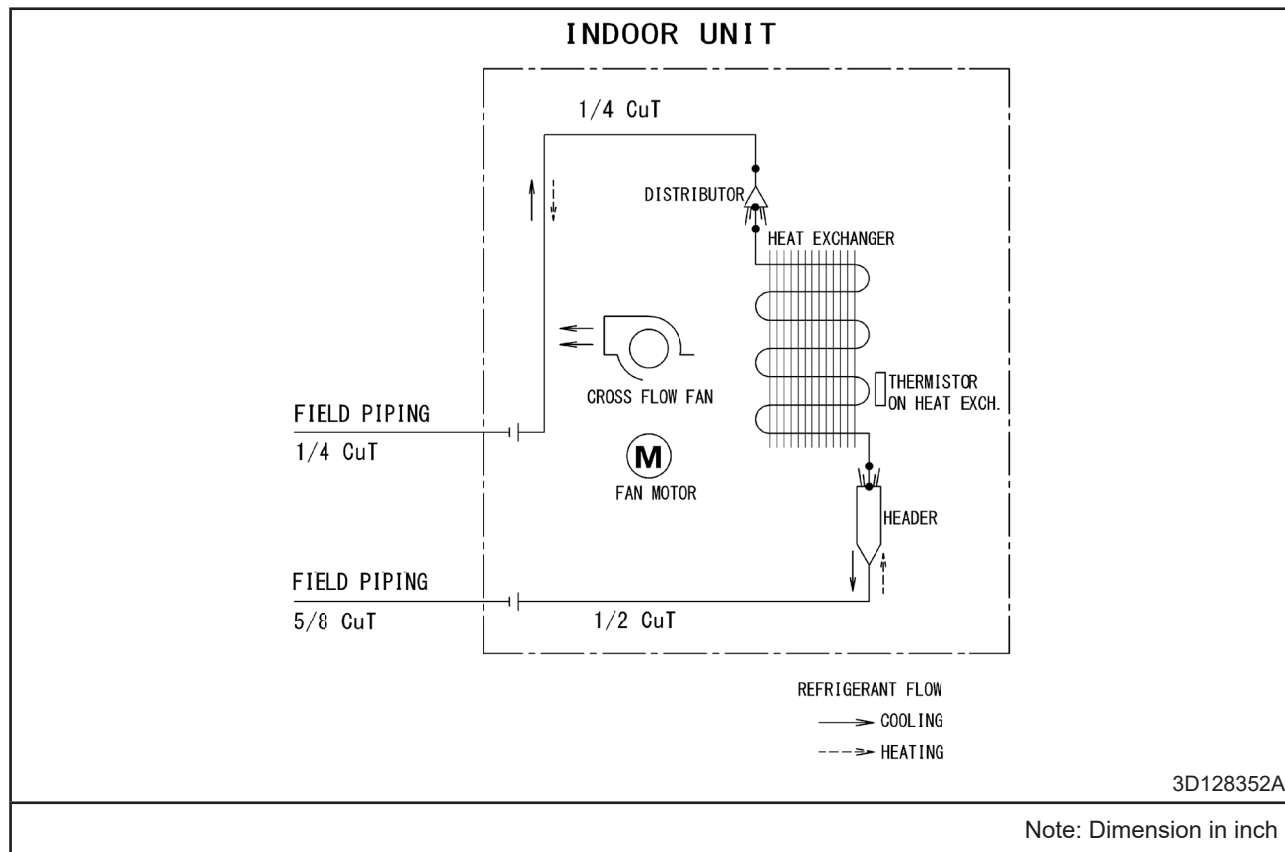

Outdoor Unit

Model : RXB09B

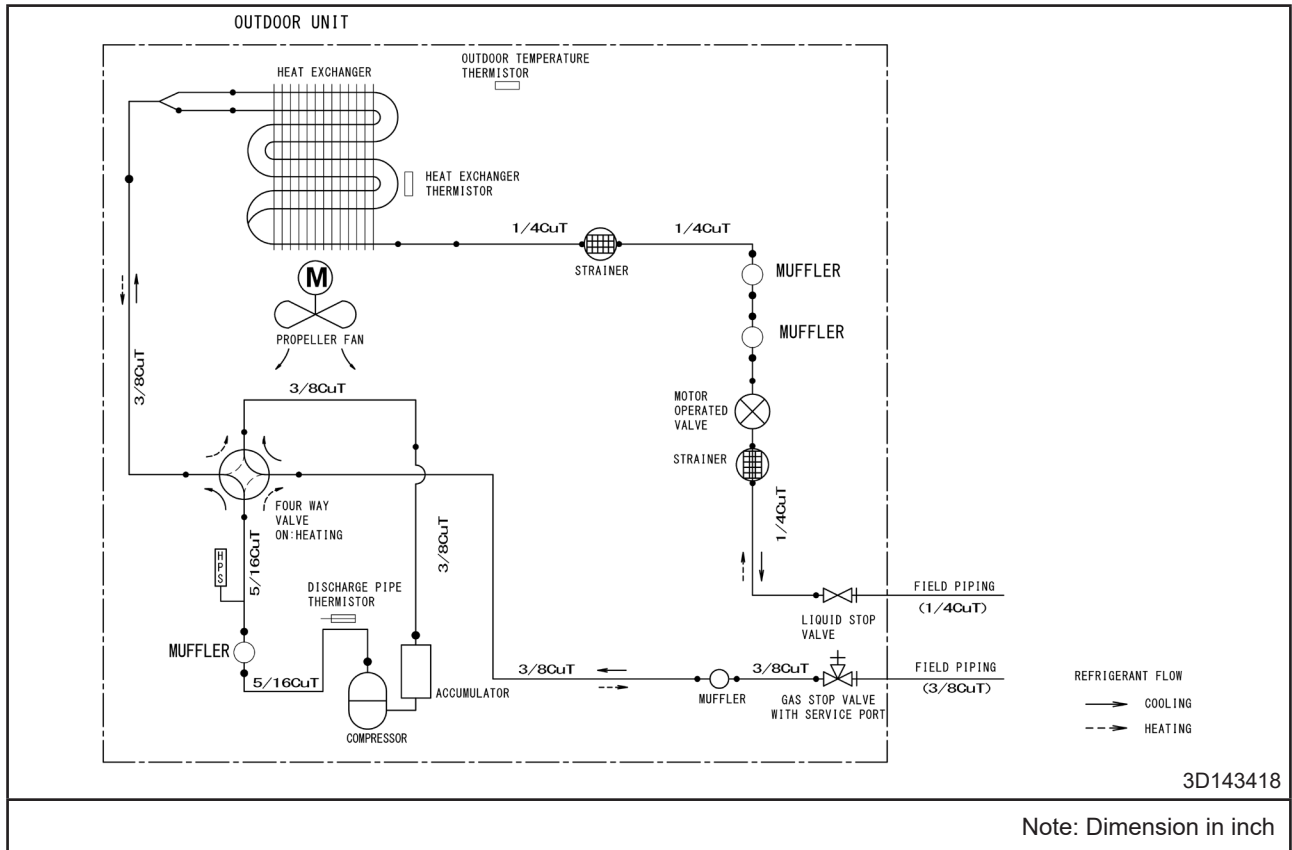

Model : RXB12B

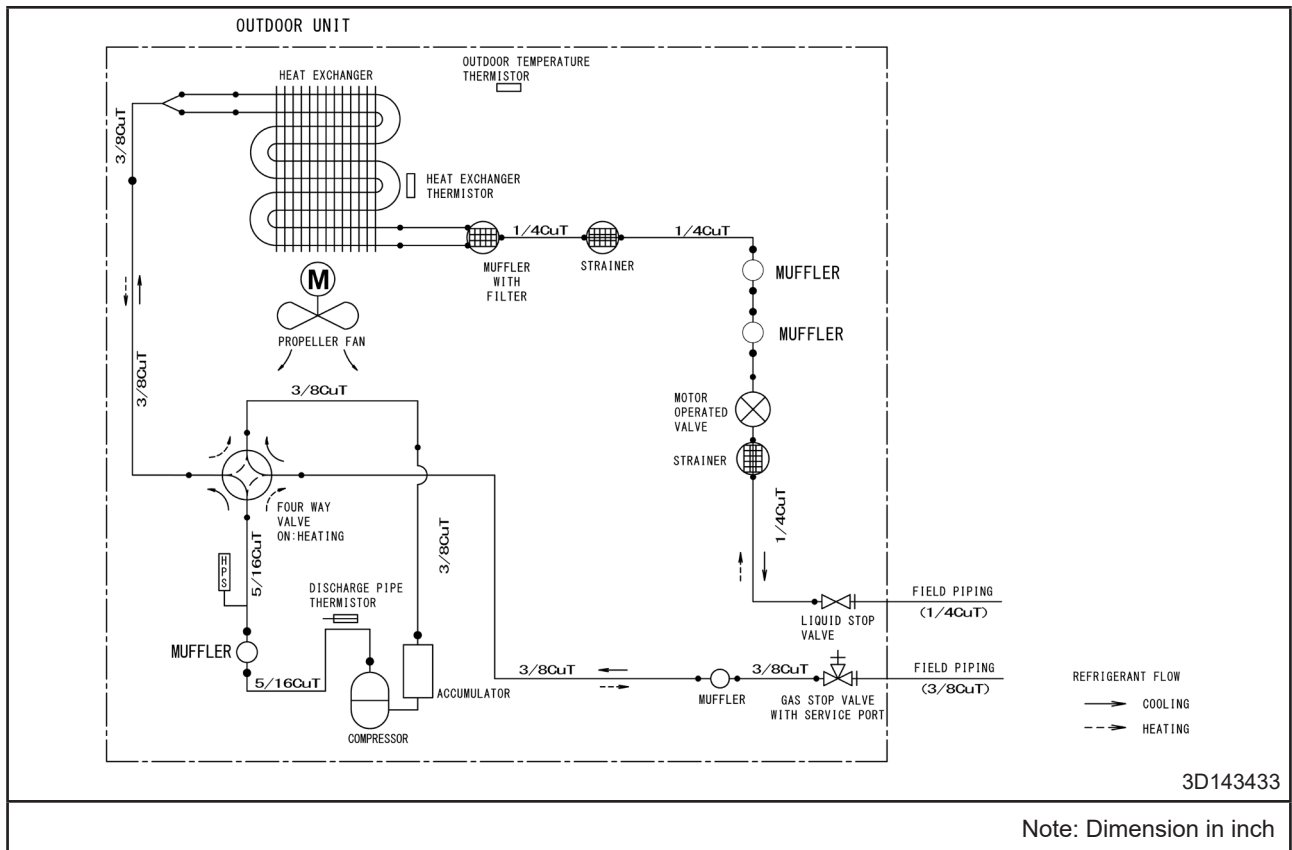

Model : RXB18B

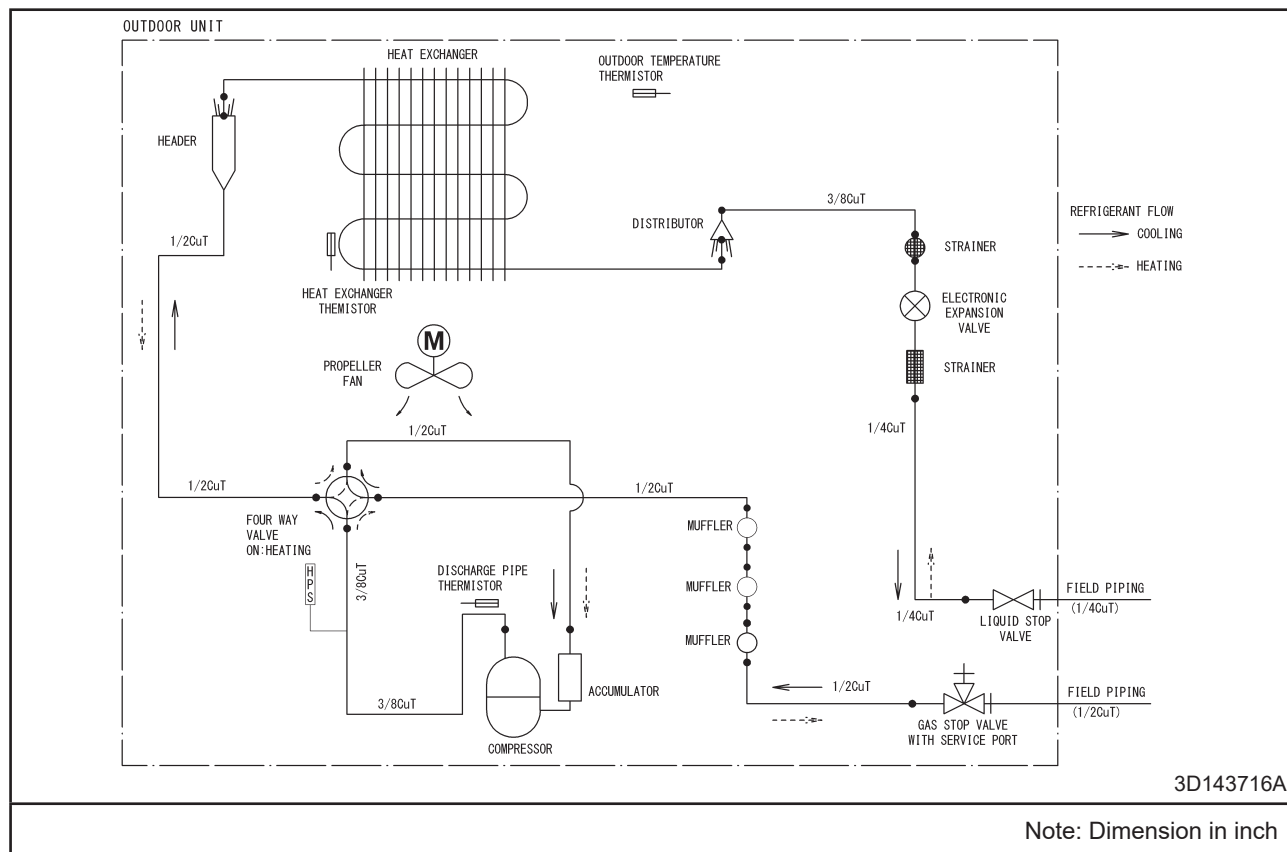

Model : RXB24B

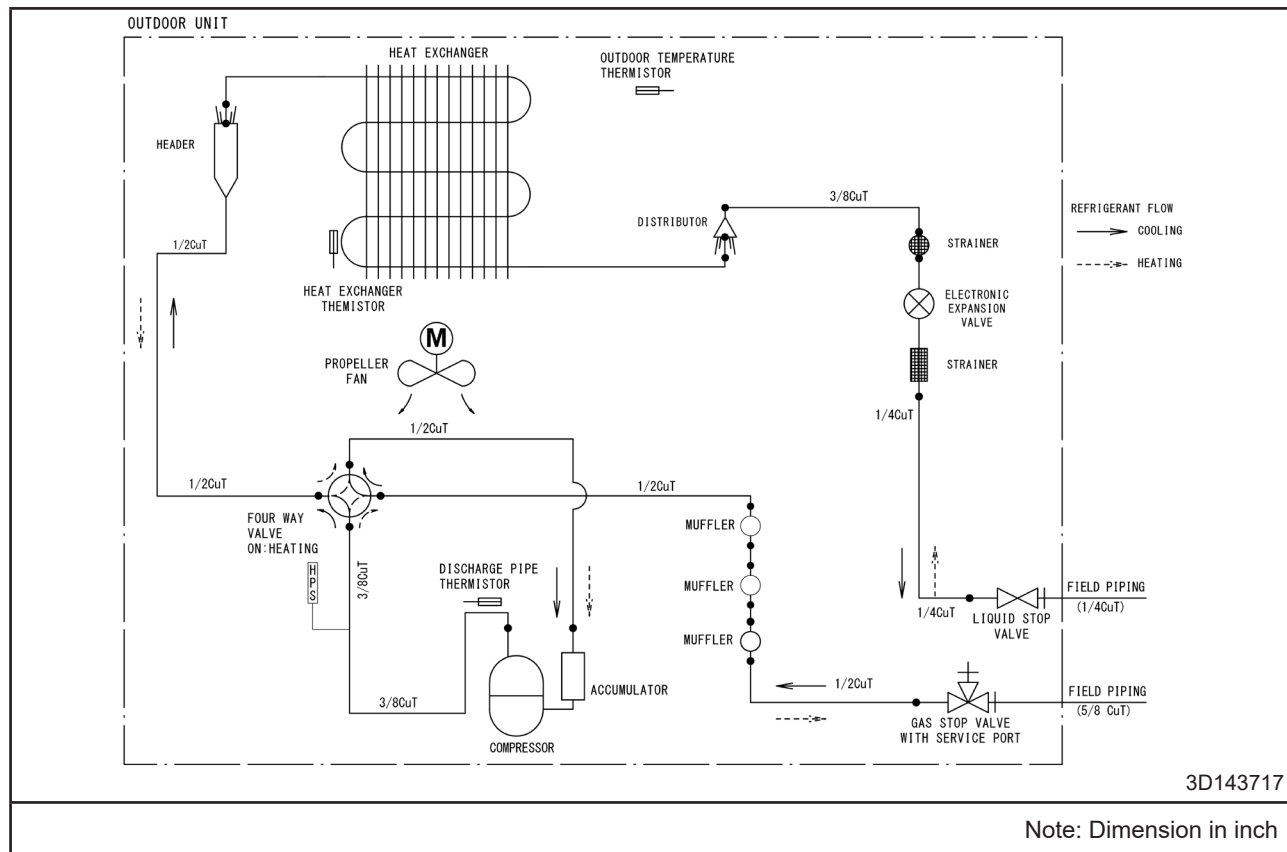

Capacity Tables

Model : FTXB09B - RXB09B

AFR	12.20
BPF	0.26

Cooling: 208 - 230V 60Hz
Temp: Celsius/TC,SHC,PI,kW

Indoor Temperature		Outdoor temperature [°C DB]																							
°C	EDB	10			20			25			30			32			35			40			46		
		TC	SHC	PI	TC	SHC	PI	TC	SHC	PI	TC	SHC	PI	TC	SHC	PI	TC	SHC	PI	TC	SHC	PI	TC	SHC	PI
14	20	3.34	2.57	0.62	2.64	2.23	0.61	2.52	2.17	0.61	2.40	2.11	0.73	2.35	2.09	0.75	2.28	2.06	0.79	2.16	2.00	0.85	1.13	1.13	0.56
16	22	3.54	2.54	0.63	2.76	2.19	0.62	2.64	2.13	0.67	2.51	2.08	0.73	2.47	2.06	0.76	2.40	2.03	0.79	2.28	1.98	0.85	1.21	1.21	0.54
18	25	3.74	2.69	0.63	2.88	2.32	0.62	2.76	2.27	0.68	2.64	2.23	0.74	2.59	2.21	0.80	2.51	2.18	0.80	2.39	2.13	0.86	1.29	1.29	0.53
19	27	3.84	2.84	0.63	2.93	2.48	0.62	2.82	2.43	0.68	2.69	2.38	0.74	2.65	2.36	0.76	2.57	2.34	0.80	2.46	2.29	0.86	1.33	1.33	0.52
21	30	4.14	2.77	0.64	3.11	2.40	0.63	2.99	2.36	0.69	2.87	2.32	0.74	2.82	2.30	0.77	2.75	2.28	0.80	2.64	2.24	0.86	1.45	1.45	0.50
24	32	4.33	2.71	0.64	3.23	2.35	0.63	3.11	2.31	0.69	2.99	2.27	0.75	2.94	2.26	0.77	2.87	2.23	0.81	2.75	2.20	0.87	1.53	1.53	0.49

Cooling: 208 - 230V 60Hz
Temp: Fahrenheit/TC,SHC,kBtu/h / PkikW

Indoor Temperature		Outdoor temperature [°F DB]																							
°F	EDB	50			68			77			86			90			95			104			115		
		TC	SHC	PI	TC	SHC	PI	TC	SHC	PI	TC	SHC	PI	TC	SHC	PI	TC	SHC	PI	TC	SHC	PI	TC	SHC	PI
57.2	68.0	11.41	8.76	0.62	9.00	7.59	0.61	8.59	7.40	0.67	8.18	7.21	0.73	8.02	7.14	0.75	7.77	7.02	0.79	7.36	6.83	0.85	3.86	3.86	0.56
60.8	71.6	12.09	8.67	0.63	9.41	7.46	0.62	8.57	7.28	0.67	8.18	7.10	0.73	8.43	7.04	0.76	8.18	6.93	0.79	7.77	7.66	0.85	4.14	4.14	0.54
64.4	77.0	12.76	9.17	0.63	9.82	7.92	0.62	9.41	7.76	0.68	9.00	7.59	0.74	8.84	7.53	0.76	8.57	7.43	0.80	8.17	7.27	0.86	4.41	4.41	0.53
67.0	80.0	13.10	9.70	0.63	10.01	8.44	0.62	9.19	8.29	0.68	9.19	8.13	0.74	9.03	8.07	0.76	8.80	7.97	0.80	8.38	7.82	0.86	4.55	4.55	0.52
71.6	86.0	14.11	9.44	0.64	10.62	8.19	0.63	10.22	8.05	0.69	9.80	7.91	0.74	9.64	7.85	0.77	9.39	7.77	0.80	9.00	7.64	0.86	4.96	4.96	0.50
75.2	89.6	14.78	9.25	0.64	11.02	8.01	0.63	10.62	7.88	0.69	10.22	7.75	0.75	10.04	7.70	0.77	9.80	7.62	0.81	9.39	7.50	0.87	5.22	5.22	0.49

Heating: 208 - 230V 60Hz
Temp: Celsius/TC,SHC,PI,kW

Indoor Temperature		Outdoor temperature [°C WB]																						
°C	EDB	-15			-10			-5			0			6			10			18				
		TC	SHC	PI	TC	SHC	PI	TC	SHC	PI	TC	SHC	PI	TC	SHC	PI	TC	SHC	PI	TC	SHC	PI		
15.0	15.0	1.31	0.50	1.58	0.52	1.84	0.55	2.11	0.72	2.85	0.76	3.10	0.78	4.69	1.33	1.33	1.33	1.33	1.33	1.33	1.33	1.33	1.33	1.33
20.0	20.0	1.23	0.51	1.49	0.54	1.76	0.56	2.03	0.74	2.75	0.77	3.00	0.80	4.43	1.34	1.34	1.34	1.34	1.34	1.34	1.34	1.34	1.34	1.34
22.0	22.0	1.20	0.52	1.46	0.54	1.73	0.57	1.99	0.74	2.71	0.78	2.97	0.81	4.32	1.35	1.35	1.35	1.35	1.35	1.35	1.35	1.35	1.35	1.35
24.0	24.0	1.16	0.52	1.43	0.55	1.69	0.57	1.96	0.75	2.68	0.78	2.93	0.81	4.22	1.35	1.35	1.35	1.35	1.35	1.35	1.35	1.35	1.35	1.35
25.0	25.0	1.15	0.53	1.41	0.55	1.68	0.58	1.95	0.76	2.66	0.79	2.91	0.82	4.17	1.36	1.36	1.36	1.36	1.36	1.36	1.36	1.36	1.36	1.36
27.0	27.0	1.12	0.53	1.38	0.56	1.65	0.58	1.91	0.76	2.62	0.80	2.87	0.82	4.06	1.36	1.36	1.36	1.36	1.36	1.36	1.36	1.36	1.36	1.36

Heating: 208 - 230V 60Hz
Temp: Fahrenheit/TC,SHC,kBtu/h / PkikW

Indoor Temperature		Outdoor temperature [°F WB]																						
°F	EDB	5			14			23			32			43			50			64				
		TC	SHC	PI	TC	SHC	PI	TC	SHC	PI	TC	SHC	PI	TC	SHC	PI	TC	SHC	PI	TC	SHC	PI		
59.0	59.0	4.46	0.50	5.38	0.52	6.28	0.55	7.20	0.72	9.72	0.76	10.57	0.78	16.00	1.33	1.33	1.33	1.33	1.33	1.33	1.33	1.33	1.33	1.33
60.0	60.0	4.21	0.51	5.10	0.54	6.01	0.56	6.92	0.74	9.40	0.77	10.25	0.80	15.11	1.34	1.34	1.34	1.34	1.34	1.34	1.34	1.34	1.34	1.34
62.0	62.0	4.09	0.52	4.99	0.54	5.90	0.57	6.80	0.74	9.26	0.78	10.12	0.81	14.75	1.35	1.35	1.35	1.35	1.35	1.35	1.35	1.35	1.35	1.35
64.0	64.0	3.97	0.52	4.88	0.55	5.78	0.57	6.68	0.75	9.14	0.78	9.99	0.81	14.40	1.35	1.35	1.35	1.35	1.35	1.35	1.35	1.35	1.35	1.35
65.0	65.0	3.92	0.53	4.82	0.55	5.74	0.58	6.65	0.76	9.08	0.79	9.92	0.82	14.22	1.36	1.36	1.36	1.36	1.36	1.36	1.36	1.36	1.36	1.36
67.0	67.0	3.81	0.53	4.72	0.56	5.61	0.58	6.52	0.76	8.94	0.80	9.79	0.82	13.85	1.36	1.36	1.36	1.36	1.36	1.36	1.36	1.36	1.36	1.36

- Notes:
- Shows nominal (rated) capacities and power input
 - TC, SHC and PI must be calculated by interpolation using the figures in the above table
 - Capacities are based on the following condition:
 - Corresponding refrigerant piping length: .25ft
 - Level difference: .0ft

Symbols
 AFR Air Flow rate (m³/min)
 BPF Bypass factor
 EWB Entering Wet Bulb (°C) / (°F)
 EDB Entering Dry Bulb (°C) / (°F)
 TC Total Capacity (kW) / (kBtu/h)
 SHC Sensible Heat Capacity (kW) / (kBtu/h)
 PI Power Input (kW)

3D143863A

Model : FTXB12B - RXB12B

AFR	12.35
BPF	0.20

Cooling: 208 - 230V 60Hz
Temp.: Celsius/TC,SHC,PI;kW

Indoor Temperature		Outdoor temperature [°C DB]																							
°C	EDB	10			20			25			30			32			35			40			46		
		TC	SHC	PI	TC	SHC	PI	TC	SHC	PI	TC	SHC	PI	TC	SHC	PI	TC	SHC	PI	TC	SHC	PI	TC	SHC	PI
14.0	20.0	4.19	3.09	1.29	3.30	2.64	0.99	3.15	2.57	1.09	3.00	2.50	1.18	2.94	2.47	1.22	2.85	2.43	1.28	2.70	2.36	1.38	1.60	1.17	1.04
16.0	22.0	4.38	3.03	1.30	3.45	2.60	1.09	3.30	2.53	1.09	3.15	2.46	1.19	3.09	2.44	1.23	3.00	2.40	1.28	2.85	2.33	1.38	1.70	1.09	1.04
18.0	25.0	4.57	3.16	1.31	3.60	2.74	1.00	3.45	2.68	1.10	3.30	2.62	1.19	3.24	2.59	1.23	3.15	2.55	1.29	3.00	2.49	1.39	1.80	1.13	1.03
19.0	27.0	4.65	3.32	1.31	3.67	2.91	1.00	3.53	2.85	1.10	3.37	2.79	1.19	3.31	2.76	1.23	3.22	2.73	1.29	3.08	2.67	1.40	1.85	1.20	1.03
22.0	30.0	4.94	3.20	1.32	3.90	2.81	1.01	3.75	2.76	1.11	3.60	2.70	1.21	3.54	2.68	1.24	3.45	2.65	1.31	3.30	2.60	1.40	2.01	1.09	1.03
24.0	32.0	5.44	3.22	1.42	4.05	2.75	1.02	3.90	2.70	1.12	3.75	2.65	1.22	3.69	2.63	1.26	3.60	2.60	1.31	3.45	2.55	1.41	2.11	1.02	1.03

Cooling: 208 - 230V 60Hz
Temp.: Fahrenheit/TC,SHC,PI;kW

Indoor Temperature		Outdoor temperature [°F DB]																							
°F	EDB	50			68			77			86			90			95			104			115		
		TC	SHC	PI	TC	SHC	PI	TC	SHC	PI	TC	SHC	PI	TC	SHC	PI	TC	SHC	PI	TC	SHC	PI	TC	SHC	PI
57.2	68.0	14.28	10.53	1.29	11.27	9.02	0.99	10.75	8.77	1.09	10.24	8.53	1.18	10.04	8.43	1.22	9.73	8.29	1.28	9.21	8.04	1.38	5.44	4.00	1.04
60.8	71.6	14.94	10.33	1.30	11.79	8.86	1.00	11.27	8.63	1.09	10.74	8.39	1.19	10.55	8.31	1.23	10.24	8.17	1.28	9.73	7.95	1.38	5.80	3.72	1.04
64.4	77.0	15.58	10.78	1.31	12.29	9.35	1.00	11.79	9.14	1.10	11.27	8.92	1.19	11.06	8.84	1.23	10.74	8.71	1.29	10.23	8.50	1.39	6.15	3.85	1.03
67.0	80.0	15.88	11.31	1.31	12.53	9.91	1.00	12.03	9.71	1.10	11.51	9.50	1.21	11.31	9.42	1.23	11.00	9.31	1.29	10.49	9.11	1.40	6.32	4.08	1.03
71.6	86.0	16.85	10.91	1.32	13.30	9.59	1.01	12.79	9.41	1.11	12.27	9.23	1.21	12.07	9.16	1.24	11.76	9.05	1.31	11.27	8.88	1.40	6.85	3.70	1.03
75.2	89.6	18.55	11.00	1.42	13.80	9.37	1.02	13.30	9.20	1.12	12.79	9.04	1.22	12.57	8.97	1.26	12.27	8.87	1.31	11.76	8.71	1.41	7.19	3.48	1.03

Heating: 208 - 230V 60Hz
Temp.: Celsius/TC,SHC,PI;kW

Indoor Temperature		Outdoor temperature [°C WB]																				
°C	EDB	-15			-10			-5			0			6			10			18		
		TC	SHC	PI	TC	SHC	PI	TC	SHC	PI	TC	SHC	PI	TC	SHC	PI	TC	SHC	PI	TC	SHC	PI
15.0	15.0	1.45	0.55	1.75	0.58	2.11	0.61	2.42	0.93	3.43	0.98	3.73	1.02	4.90	1.44							
20.0	20.0	1.37	0.56	1.66	0.59	2.02	0.62	2.33	0.96	3.31	1.00	3.61	1.04	4.71	1.48							
22.0	20.0	1.33	0.57	1.62	0.60	1.98	0.63	2.29	0.96	3.26	1.01	3.57	1.05	4.63	1.49							
24.0	20.0	1.29	0.57	1.59	0.61	1.94	0.63	2.25	0.97	3.22	1.02	3.52	1.06	4.55	1.50							
25.0	20.0	1.27	0.58	1.57	0.61	1.93	0.64	2.23	0.98	3.20	1.02	3.49	1.06	4.52	1.51							
27.0	20.0	1.24	0.58	1.53	0.62	1.89	0.64	2.19	0.98	3.15	1.04	3.45	1.07	4.60	1.66							

Heating: 208 - 230V 60Hz
Temp.: Fahrenheit/TC,SHC,PI;kW

Indoor Temperature		Outdoor temperature [°F WB]																				
°F	EDB	5			14			23			32			43			50			64		
		TC	SHC	PI	TC	SHC	PI	TC	SHC	PI	TC	SHC	PI	TC	SHC	PI	TC	SHC	PI	TC	SHC	PI
59.0	70.0	4.95	0.55	5.96	0.58	7.20	0.61	8.25	0.93	11.69	0.98	12.71	1.02	16.71	1.44							
70.0	70.0	4.67	0.56	5.66	0.59	6.89	0.62	7.93	0.96	11.30	1.00	12.33	1.04	16.06	1.48							
71.6	70.0	4.53	0.57	5.54	0.60	6.76	0.63	7.80	0.96	11.14	1.01	12.17	1.05	15.79	1.49							
75.2	70.0	4.41	0.57	5.42	0.61	6.63	0.64	7.66	0.97	10.99	1.02	12.01	1.06	15.51	1.50							
77.0	70.0	4.35	0.58	5.34	0.61	6.58	0.64	7.62	0.98	10.91	1.02	11.92	1.06	15.43	1.51							
80.6	70.0	4.23	0.58	5.23	0.62	6.44	0.64	7.48	0.98	10.75	1.04	11.78	1.07	15.70	1.66							

- Symbols
- AFR Air Flow rate (m³/min)
 - BPF Bypass factor
 - EWB Entering Wet Bulb (°C)/(°F)
 - EDB Entering Dry Bulb (kW)/(kBtu/h)
 - TC Total Capacity (kW)/(kBtu/h)
 - SHC Sensible Heat Capacity (kW)
 - PI Power Input

NOTES:

- Shows nominal (rated) capacities and power input
- TC, SHC and PI must be calculated by interpolation using the figures in the above table
- Capacities are based on the following condition
Corresponding refrigerant piping length : 25ft
Level difference : 0ft

Model : FTXB18B - RXB18B

AFR	20.27
BPF	0.31

Cooling: 208 - 230V 60Hz
Temp.: Celsius/TC,SHC,PI/kW

Indoor Temperature °C	Outdoor temperature [°C DB]																								
	10			20			25			30			32			35			40			46			
EWB	EDB	TC	SHC	PI	TC	SHC	PI	TC	SHC	PI	TC	SHC	PI	TC	SHC	PI	TC	SHC	PI	TC	SHC	PI			
14	20	6.85	2.92	1.34	5.41	4.10	1.31	17.59	1.44	16.75	13.15	1.56	16.42	12.99	1.61	15.92	12.75	1.70	15.07	12.34	1.82	7.90	6.94	1.19	
16	22	7.26	2.88	1.35	5.65	4.03	1.32	5.40	3.91	1.45	5.15	3.79	1.58	5.06	3.75	1.63	4.91	3.68	1.70	4.67	3.57	1.83	2.48	2.17	1.17
18	25	7.66	3.10	1.36	5.89	4.22	1.33	5.65	4.11	1.46	5.40	4.01	1.58	5.31	3.96	1.63	5.15	3.90	1.71	4.90	3.80	1.84	2.65	2.28	1.14
19	27	7.86	3.22	1.36	6.01	4.45	1.33	5.77	4.34	1.46	5.52	4.24	1.58	5.42	4.20	1.63	5.27	4.14	1.71	5.03	4.04	1.85	2.73	2.34	1.12
22	30	8.47	3.26	1.37	6.38	4.29	1.34	6.13	4.20	1.47	5.88	4.11	1.60	5.79	4.08	1.65	5.64	4.02	1.73	5.40	3.94	1.86	2.98	2.52	1.08
24	32	8.87	3.20	1.38	6.62	4.18	1.36	6.38	4.10	1.48	6.13	4.02	1.61	6.03	3.99	1.66	5.88	3.94	1.73	5.64	3.86	1.86	3.14	2.65	1.05

Cooling: 208 - 230V 60Hz
Temp.: Fahrenheit/TC,SHC,kBtu/h / P/kW

Indoor Temperature °F	Outdoor temperature [°F DB]																								
	50			68			77			86			90			95			104			115			
EWB	EDB	TC	SHC	PI	TC	SHC	PI	TC	SHC	PI	TC	SHC	PI	TC	SHC	PI	TC	SHC	PI	TC	SHC	PI			
57.2	68.0	23.37	9.95	1.34	18.44	14.00	1.31	17.59	1.44	16.75	13.15	1.56	16.42	12.99	1.61	15.92	12.75	1.70	15.07	12.34	1.82	7.90	6.94	1.19	
60.8	71.6	24.76	9.82	1.35	19.28	13.74	1.32	18.43	1.34	1.45	17.56	12.94	1.58	17.26	12.80	1.63	16.75	12.57	1.70	15.92	12.19	1.83	8.47	7.39	1.17
64.4	77.0	26.14	10.59	1.36	20.11	14.39	1.33	19.28	1.40	1.46	18.43	13.67	1.58	18.10	13.53	1.63	17.56	13.30	1.71	16.74	12.95	1.84	9.03	7.78	1.14
67.0	80.0	26.83	10.97	1.36	20.51	15.17	1.33	19.68	1.48	1.46	18.82	14.47	1.58	18.50	14.33	1.63	18.00	14.13	1.71	17.17	13.80	1.85	9.32	7.99	1.12
71.6	86.0	28.91	11.11	1.37	21.75	14.64	1.34	20.93	1.43	1.47	20.07	14.02	1.60	19.74	13.90	1.65	19.23	13.72	1.73	18.43	13.43	1.86	10.16	8.60	1.08
75.2	89.6	30.28	10.90	1.38	22.58	14.28	1.36	21.75	13.99	1.48	20.93	13.72	1.61	20.57	13.60	1.66	20.07	13.43	1.73	19.23	13.16	1.86	10.70	9.03	1.05

Heating: 208 - 230V 60Hz
Temp.: Celsius/TC,SHC,PI/kW

Indoor Temperature °C	Outdoor temperature [°C WB]																
	-15			-10			-5			0			10			18	
EWB	EDB	TC	SHC	PI	TC	SHC	PI	TC	SHC	PI	TC	SHC	PI	TC	SHC	PI	
15.0	2.49	1.02	3.00	1.07	3.51	1.13	4.02	1.47	5.42	1.56	5.90	1.61	8.93	2.73	2.73	2.73	
20.0	2.35	1.05	2.85	1.10	3.35	1.15	3.86	1.52	5.24	1.59	5.72	1.64	8.43	2.76	2.76	2.76	
22.0	2.28	1.06	2.79	1.12	3.29	1.17	3.80	1.52	5.17	1.60	5.65	1.66	8.23	2.77	2.77	2.77	
24.0	2.22	1.07	2.73	1.13	3.23	1.18	3.73	1.54	5.10	1.61	5.58	1.67	8.04	2.78	2.78	2.78	
25.0	2.19	1.08	2.69	1.13	3.20	1.19	3.71	1.55	5.07	1.62	5.53	1.68	7.94	2.79	2.79	2.79	
27.0	2.13	1.09	2.63	1.15	3.13	1.20	3.64	1.56	4.99	1.64	5.47	1.69	7.73	2.80	2.80	2.80	

Heating: 208 - 230V 60Hz
Temp.: Fahrenheit/TC,SHC,kBtu/h / P/kW

Indoor Temperature °F	Outdoor temperature [°F WB]																			
	5			14			23			32			43			50			64	
EWB	EDB	TC	SHC	PI	TC	SHC	PI	TC	SHC	PI	TC	SHC	PI	TC	SHC	PI				
59.0	8.50	1.02	10.24	1.07	11.96	1.13	13.71	1.47	18.51	1.56	20.13	1.61	30.47	2.73	2.73	2.73				
20.0	8.02	1.05	9.71	1.10	11.44	1.15	13.18	1.52	17.90	1.59	19.52	1.64	28.78	2.76	2.76	2.76				
22.0	7.78	1.06	9.51	1.12	11.23	1.17	12.95	1.52	17.64	1.60	19.27	1.66	28.10	2.77	2.77	2.77				
24.0	7.57	1.07	9.30	1.13	11.01	1.18	12.73	1.54	17.40	1.61	19.03	1.67	27.42	2.78	2.78	2.78				
25.0	7.46	1.08	9.17	1.13	10.93	1.19	12.66	1.55	17.28	1.62	18.88	1.68	27.08	2.79	2.79	2.79				
27.0	7.26	1.09	8.98	1.15	10.69	1.20	12.42	1.56	17.02	1.64	18.65	1.69	26.38	2.80	2.80	2.80				

Symbols

- AFR Air Flow rate (m³/min)
- BPF Bypass factor
- EWB Entering Wet Bulb
- EDB Entering Dry Bulb
- TC Total Capacity (kW) / (kBtu/h)
- SHC Sensible Heat Capacity (kW)
- PI Power Input

NOTES:

- 1) Shows nominal (rated) capacities and power input
- 2) TC, SHC and PI must be calculated by interpolation using the figures in the above table
- 3) Capacities are based on the following condition
Corresponding refrigerant piping length .25ft
Level difference .0ft

Model : FTXB24B - RXB24B

AFR	20.27
BPF	0.31

Cooling: 208 - 230V 60Hz
Temp.: Celsius/ TC,SHC,PI/kW

Indoor Temperature	Outdoor temperature [°C DB]																					
	10			20			25			30			35			40			46			
°C	TC	SHC	PI	TC	SHC	PI	TC	SHC	PI	TC	SHC	PI	TC	SHC	PI	TC	SHC	PI	TC	SHC	PI	
14	20	8.07	1.58	6.37	4.60	1.54	6.07	4.45	1.70	5.78	4.30	1.84	5.67	4.24	1.90	5.50	4.15	2.00	5.20	4.00	2.15	2.73
16	22	8.55	2.88	6.66	4.51	1.56	6.36	4.37	1.70	6.06	4.22	1.86	5.96	4.17	1.92	5.78	4.09	2.00	5.50	3.95	2.16	2.93
18	25	9.03	3.10	6.94	4.69	1.57	6.66	4.56	1.72	6.36	4.43	1.86	6.25	4.38	1.92	6.06	4.29	2.02	5.78	4.17	2.16	3.12
19	27	9.26	3.22	7.08	4.91	1.57	6.79	4.78	1.72	6.50	4.65	1.86	6.39	4.61	1.92	6.21	4.53	2.02	5.93	4.41	2.18	3.22
22	30	9.98	3.26	7.51	4.73	1.58	7.22	4.62	1.74	6.93	4.50	1.88	6.82	4.46	1.94	6.64	4.39	2.04	6.36	4.29	2.19	3.51
24	32	10.45	3.20	7.80	4.60	1.60	7.51	4.50	1.74	7.22	4.40	1.90	7.10	4.35	1.96	6.93	4.29	2.04	6.64	4.19	2.20	3.69

Cooling: 208 - 230V 60Hz
Temp.: Fahrenheit/ TC,SHC,kBtu/h/ PI/kW

Indoor Temperature	Outdoor temperature [°F DB]																								
	50			68			77			86			90			95			104			115			
°F	TC	SHC	PI	TC	SHC	PI	TC	SHC	PI	TC	SHC	PI	TC	SHC	PI	TC	SHC	PI	TC	SHC	PI	TC	SHC	PI	
57.2	68.0	27.53	9.95	1.58	21.72	15.70	1.54	20.72	15.17	1.70	19.73	14.66	1.84	19.34	14.46	1.90	18.75	14.16	2.00	17.75	13.65	2.15	9.31	6.94	1.41
60.8	71.6	29.17	9.82	1.59	22.72	15.40	1.56	21.71	14.91	1.70	20.69	14.41	1.86	20.33	14.24	1.92	19.73	13.95	2.00	18.75	13.49	2.16	9.98	7.39	1.37
64.4	77.0	30.80	10.59	1.60	23.69	16.01	1.57	22.72	15.56	1.72	21.71	15.10	1.86	21.32	14.93	1.92	20.69	14.65	2.02	19.71	14.22	2.16	10.64	7.78	1.34
67.0	80.0	31.61	10.97	1.60	24.15	16.75	1.57	23.18	16.32	1.72	22.17	15.88	1.86	21.79	15.71	1.92	21.20	15.46	2.02	20.22	15.05	2.18	10.97	7.99	1.32
71.6	86.0	34.05	11.11	1.61	25.62	16.13	1.58	24.65	15.75	1.74	23.64	15.36	1.88	23.26	15.21	1.94	22.65	14.98	2.04	21.71	14.63	2.19	11.96	8.60	1.27
75.2	89.6	35.66	10.90	1.62	26.60	15.69	1.60	25.62	15.34	1.74	24.65	15.00	1.90	24.23	14.85	1.96	23.64	14.64	2.04	22.65	14.30	2.20	12.60	9.03	1.24

Heating: 208 - 230V 60Hz
Temp.: Celsius/ TC,SHC,PI/kW

Indoor Temperature	Outdoor temperature [°C WB]																				
	-15			-10			-5			0			6			10			18		
°C	TC	SHC	PI	TC	SHC	PI	TC	SHC	PI	TC	SHC	PI	TC	SHC	PI	TC	SHC	PI	TC	SHC	PI
15.0	20.0	2.95	1.13	3.56	1.19	4.15	1.26	4.76	1.64	5.37	1.73	5.99	1.79	6.61	2.00	7.23	2.38	2.73	3.08	3.43	3.78
20.0	27.0	2.78	1.17	3.37	1.22	3.97	1.28	4.57	1.68	5.17	1.77	5.79	1.82	6.41	1.84	7.04	2.19	2.54	2.89	3.24	3.59
22.0	27.0	2.70	1.18	3.30	1.24	3.90	1.30	4.50	1.69	5.10	1.78	5.72	1.84	6.36	1.90	6.97	2.20	2.55	2.90	3.25	3.60
24.0	26.3	2.63	1.19	3.23	1.26	3.82	1.31	4.42	1.71	5.04	1.79	5.66	1.86	6.31	1.90	6.98	2.21	2.56	2.91	3.26	3.61
25.0	25.0	2.59	1.20	3.18	1.26	3.79	1.32	4.39	1.72	5.00	1.80	5.62	1.87	6.30	1.91	6.92	2.22	2.57	2.92	3.27	3.62
27.0	25.0	2.52	1.21	3.12	1.28	3.71	1.33	4.31	1.73	4.91	1.82	5.54	1.88	6.24	1.92	6.86	2.23	2.58	2.93	3.28	3.63

Heating: 208 - 230V 60Hz
Temp.: Fahrenheit/ TC,SHC,kBtu/h/ PI/kW

Indoor Temperature	Outdoor temperature [°F WB]																					
	5			14			23			32			43			50			64			
°F	TC	SHC	PI	TC	SHC	PI	TC	SHC	PI	TC	SHC	PI	TC	SHC	PI	TC	SHC	PI	TC	SHC	PI	
59.0	10.07	1.13	12.13	1.19	14.17	1.26	16.24	1.64	21.92	1.73	23.85	1.79	25.76	1.84	27.61	1.90	29.46	2.00	31.31	2.10	33.16	2.19
20.0	9.50	1.17	11.51	1.22	13.56	1.28	15.61	1.68	21.20	1.77	23.12	1.82	24.99	1.84	26.78	1.90	28.57	1.99	30.36	2.08	32.03	2.17
22.0	9.22	1.18	11.27	1.24	13.31	1.30	15.34	1.69	20.89	1.78	22.83	1.84	24.62	1.90	26.50	1.99	28.26	2.08	30.03	2.17	31.80	2.26
24.0	8.97	1.19	11.02	1.26	13.04	1.31	15.08	1.71	20.61	1.79	22.54	1.86	24.38	1.90	26.25	1.99	27.98	2.08	29.75	2.17	31.53	2.25
25.0	8.84	1.20	10.86	1.26	12.94	1.32	14.99	1.72	20.47	1.80	22.37	1.87	24.17	1.90	25.99	1.99	27.70	2.08	29.56	2.17	31.31	2.24
27.0	8.60	1.21	10.64	1.28	12.66	1.33	14.71	1.73	20.17	1.82	22.09	1.88	23.95	1.90	25.72	1.99	27.43	2.08	29.35	2.17	31.09	2.23

- Symbols
- AFR Air Flow rate (m³/min)
 - BPF Bypass factor
 - EWB Entering Wet Bulb
 - EDB Entering Dry Bulb
 - TC Total Capacity (kW)/(kBtu/h)
 - SHC Sensible Heat Capacity (kW)
 - PI Power Input
- NOTES:
- Shows nominal (rated) capacities and power input
 - TC, SHC and PI must be calculated by interpolation using the figures in the above table
 - Capacities are based on the following condition:
Corresponding refrigerant piping length : 25ft
Level difference : 0ft

Capacity correction factor by the length of refrigerant piping

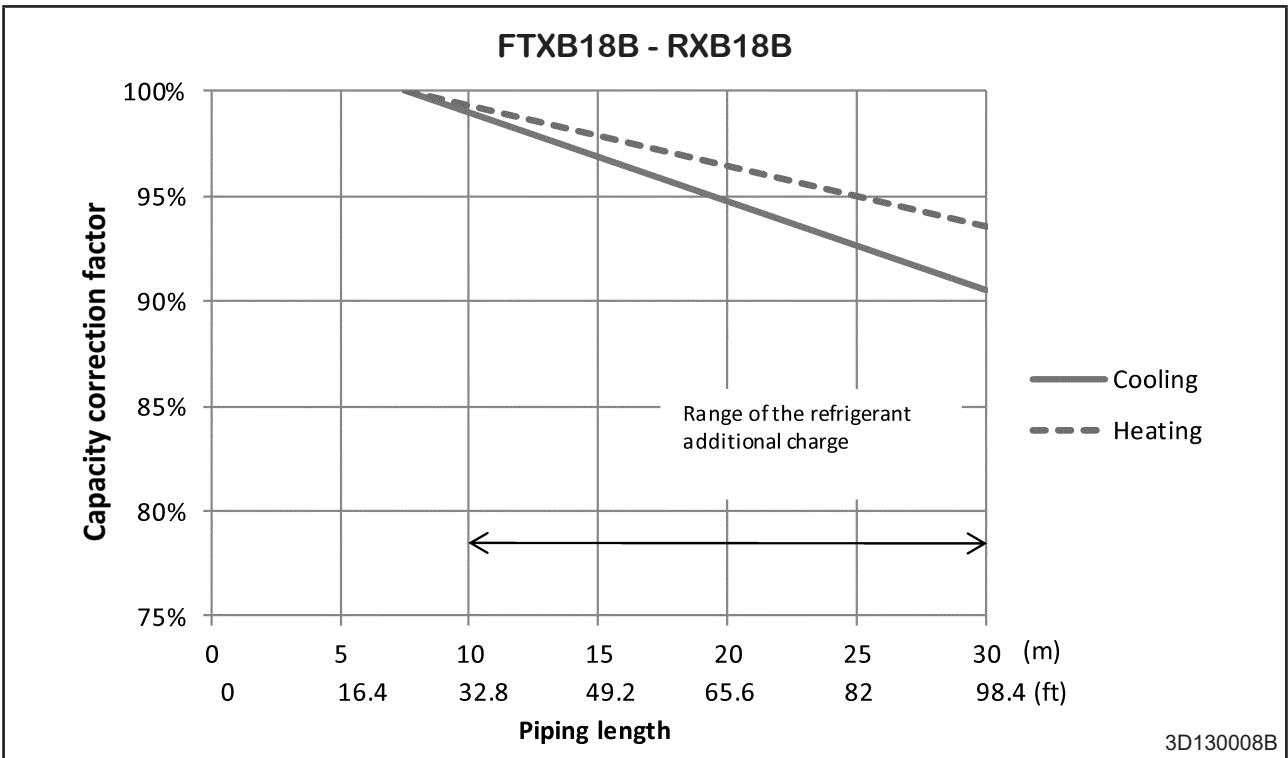
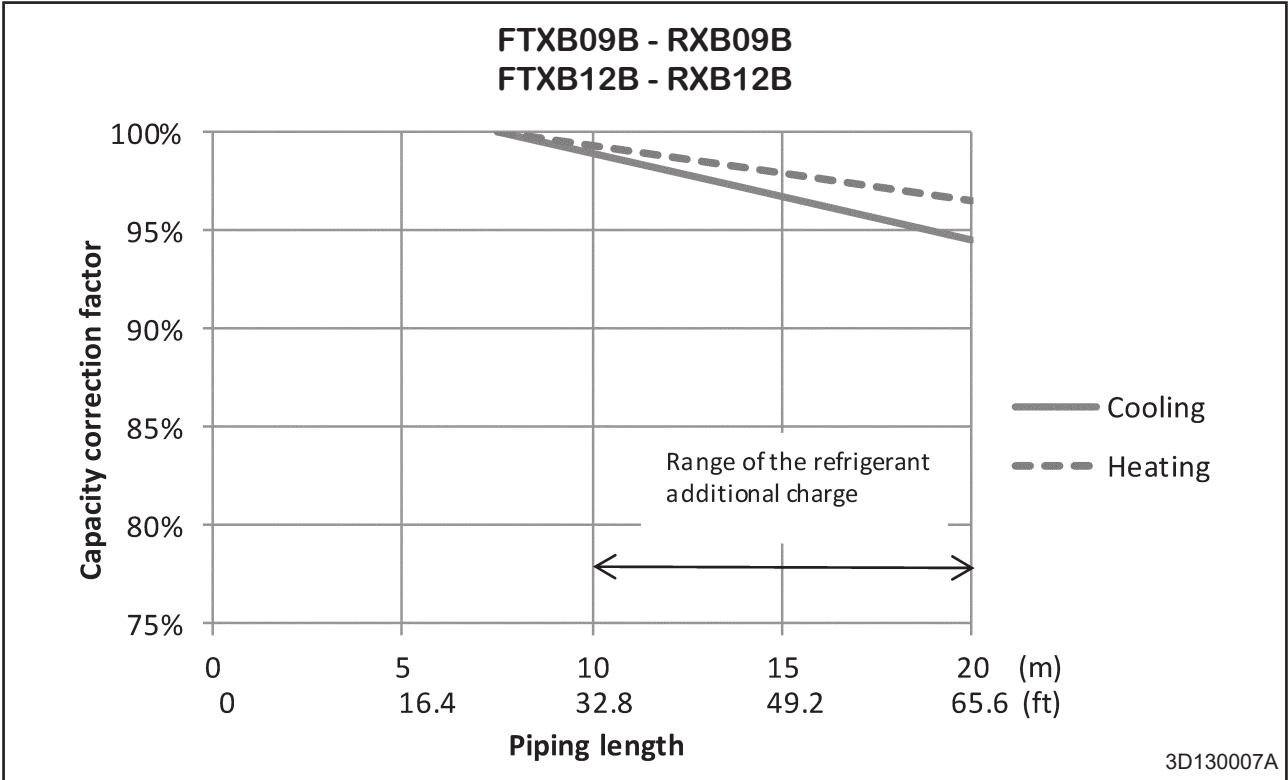

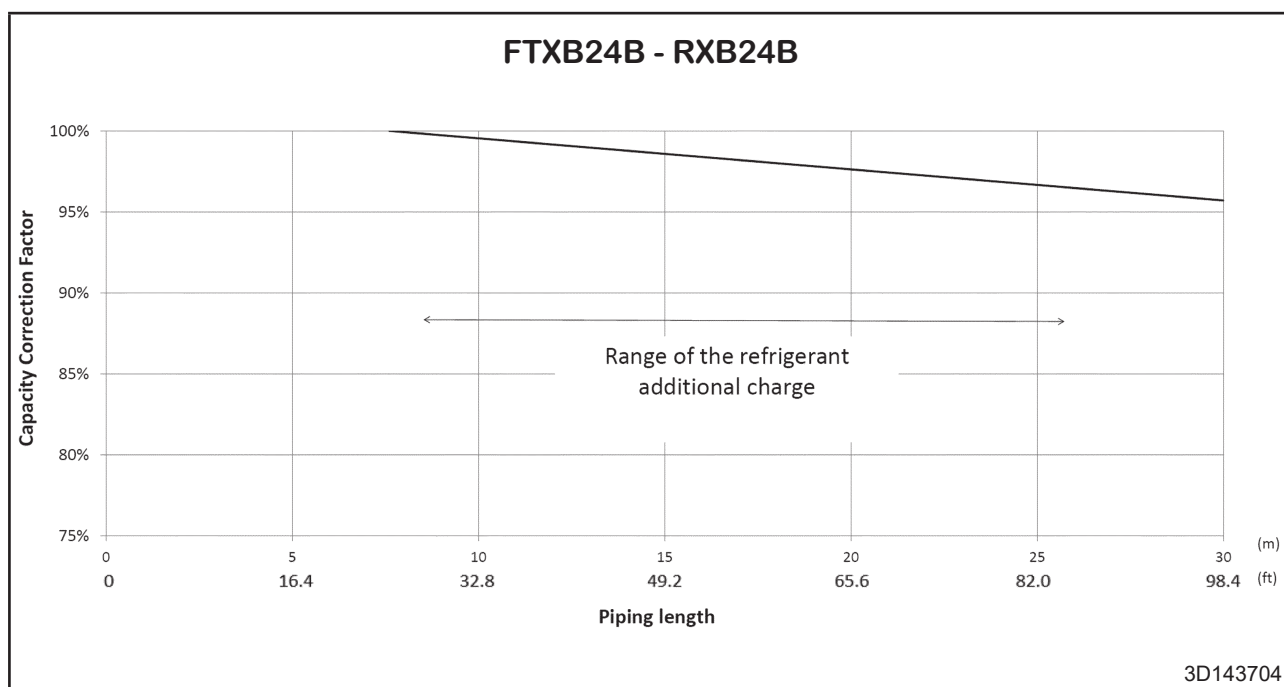
**Notes:**

- 1.----- represents the capacity correction factor for the capacity when additional refrigerant of the proper quantity is charged.
- 2.The correction ratio remains the same whether the outdoor unit is to be installed above or below the unit.
- 3.Calculation method for capacity
Capacity = capacity obtained from engineering data x capacity correction factor
- 4.The actual unit piping length shall not exceed the maximum piping length shown on the table.

Operation Limit

Model : RXB-B

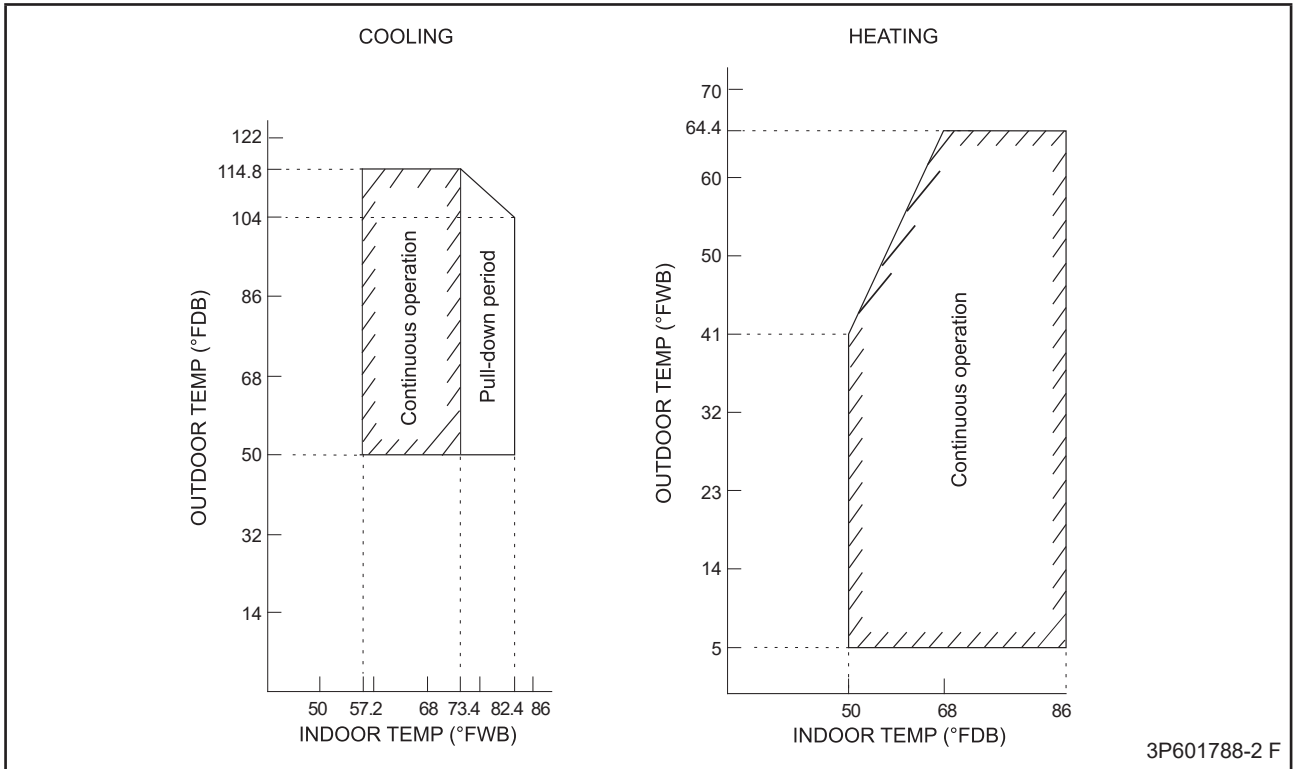

3P601788-2 F

Sound Level

Measuring Location

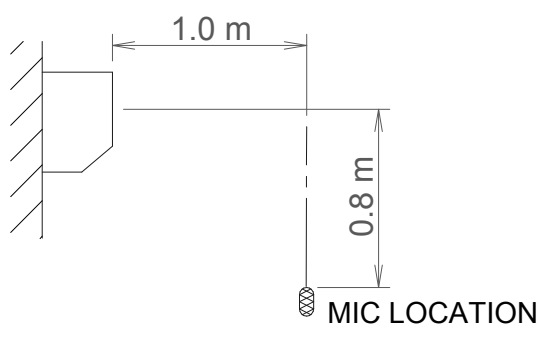
Model	Measuring Location
FTXB09B FTXB12B FTXB18B FTXB24B	 <p>The diagram illustrates the measurement setup. A device is positioned on the left, with a microphone (MIC LOCATION) placed to its right. The horizontal distance between the device and the microphone is 1.0 m. The vertical distance between the device's center and the microphone is 0.8 m.</p>

Notes:

1. Operation sound is measured in an anechoic chamber.

Sound Pressure Level

Model	Speed	1/1 Octave A-weighted Sound Pressure Level (dB, ref 20μPa)								Overall (dBA)	Noise Criteria
		63Hz	125Hz	250Hz	500Hz	1kHz	2kHz	4kHz	8kHz		
FTXB09B (Cooling)	High	54	43	41	39	39	35	26	15	43	38
	Med	45	35	36	33	32	26	17	12	36	31
	Low	37	28	30	27	25	19	12	10	29	23
	Quiet	25	19	20	16	13	10	8	9	19	0

NC Curve

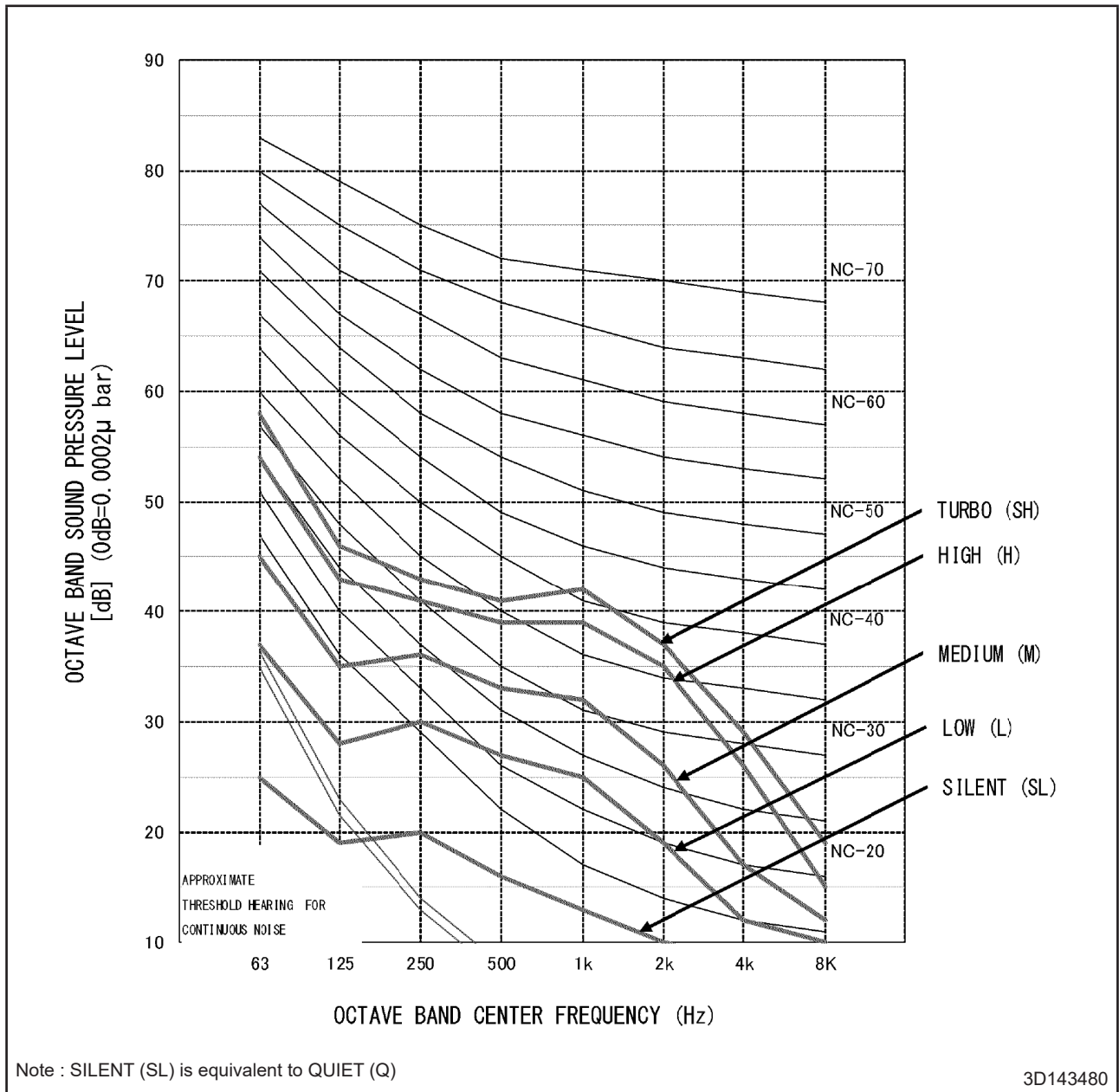

Sound Pressure Level

Model	Speed	1/1 Octave A-weighted Sound Pressure Level (dB, ref 20μPa)								Overall (dBA)	Noise Criteria
		63Hz	125Hz	250Hz	500Hz	1kHz	2kHz	4kHz	8kHz		
FTXB09B (Heating)	High	49	37	39	37	40	34	26	15	42	39
	Med	36	29	37	33	31	24	13	11	35	30
	Low	30	23	32	26	24	16	12	10	29	22
	Quiet	23	21	29	23	19	11	11	9	25	17

NC Curve

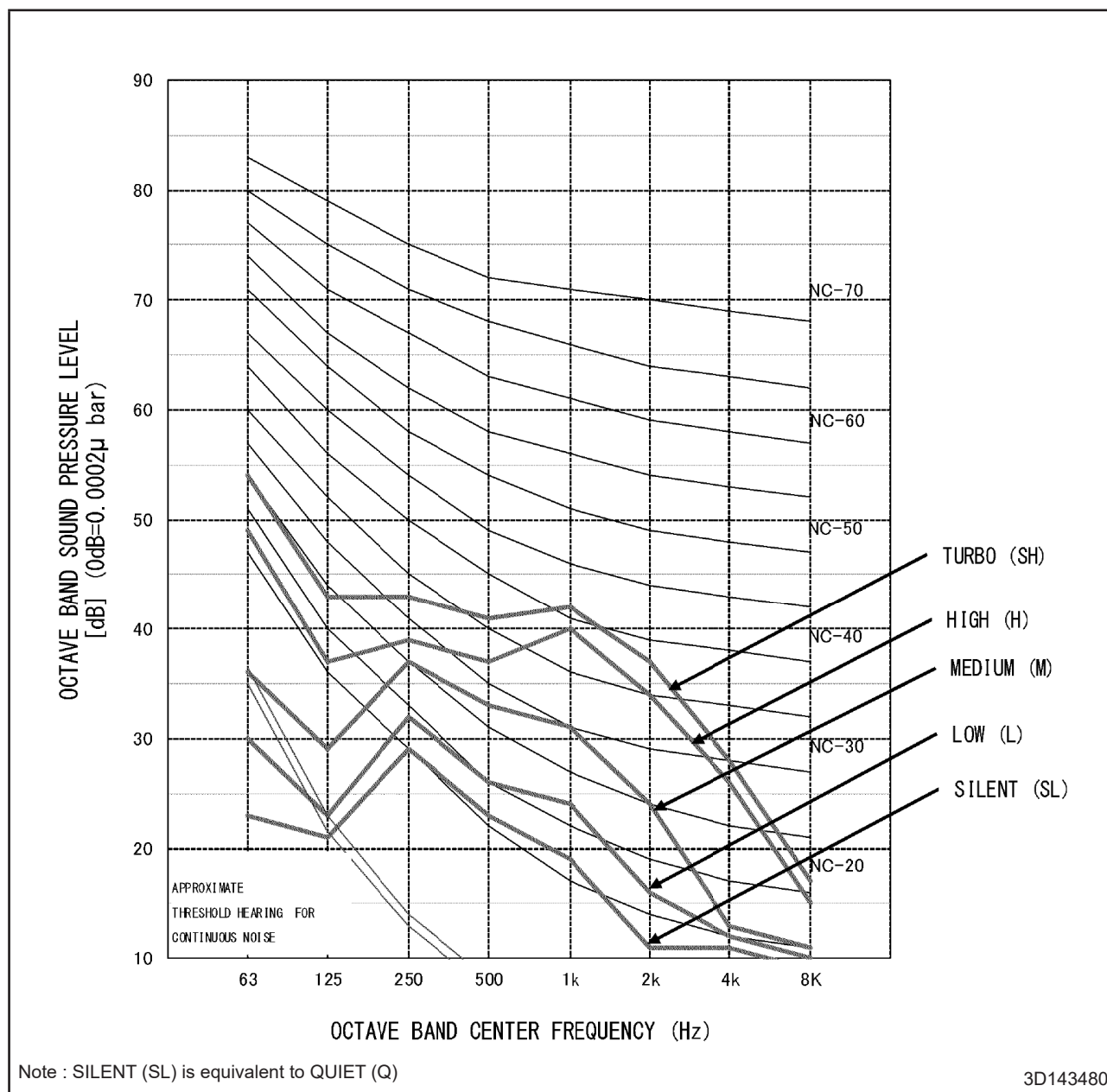

Sound Pressure Level

Model	Speed	1/1 Octave A-weighted Sound Pressure Level (dB, ref 20μPa)								Overall (dBA)	Noise Criteria
		63Hz	125Hz	250Hz	500Hz	1kHz	2kHz	4kHz	8kHz		
FTXB12B (Cooling)	High	44	36	42	40	43	37	29	19	45	42
	Med	34	29	35	33	34	28	19	12	37	33
	Low	26	24	30	29	27	21	14	11	31	25
	Quiet	17	19	18	16	13	11	10	9	19	0

NC Curve

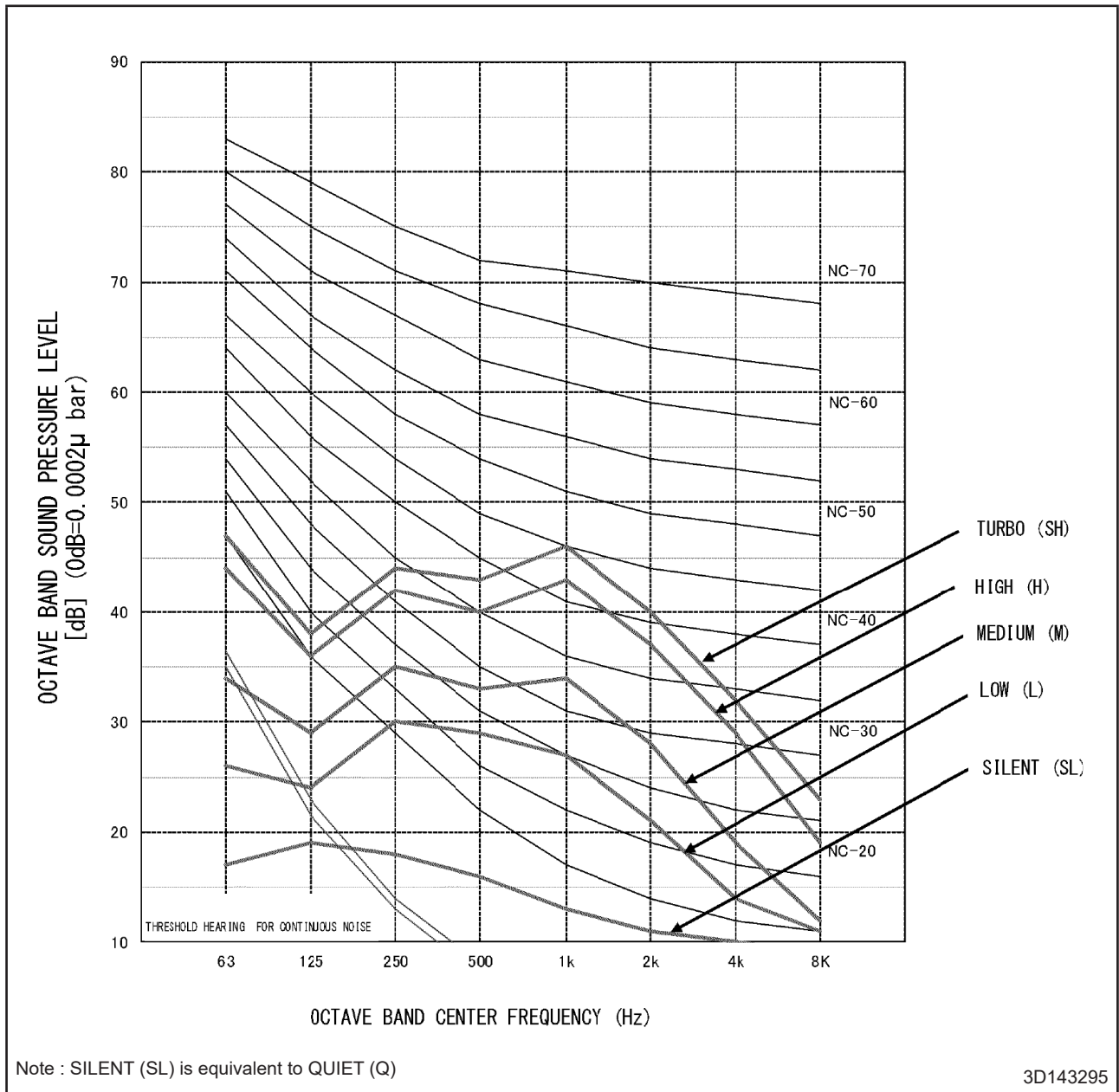

Sound Pressure Level

Model	Speed	1/1 Octave A-weighted Sound Pressure Level (dB, ref 20μPa)								Overall (dBA)	Noise Criteria
		63Hz	125Hz	250Hz	500Hz	1kHz	2kHz	4kHz	8kHz		
FTXB12B (Heating)	High	47	36	40	38	41	34	23	12	43	40
	Med	39	29	37	33	32	24	14	11	36	31
	Low	29	25	32	28	26	17	12	11	30	24
	Quiet	28	24	29	25	20	12	10	10	26	19

NC Curve

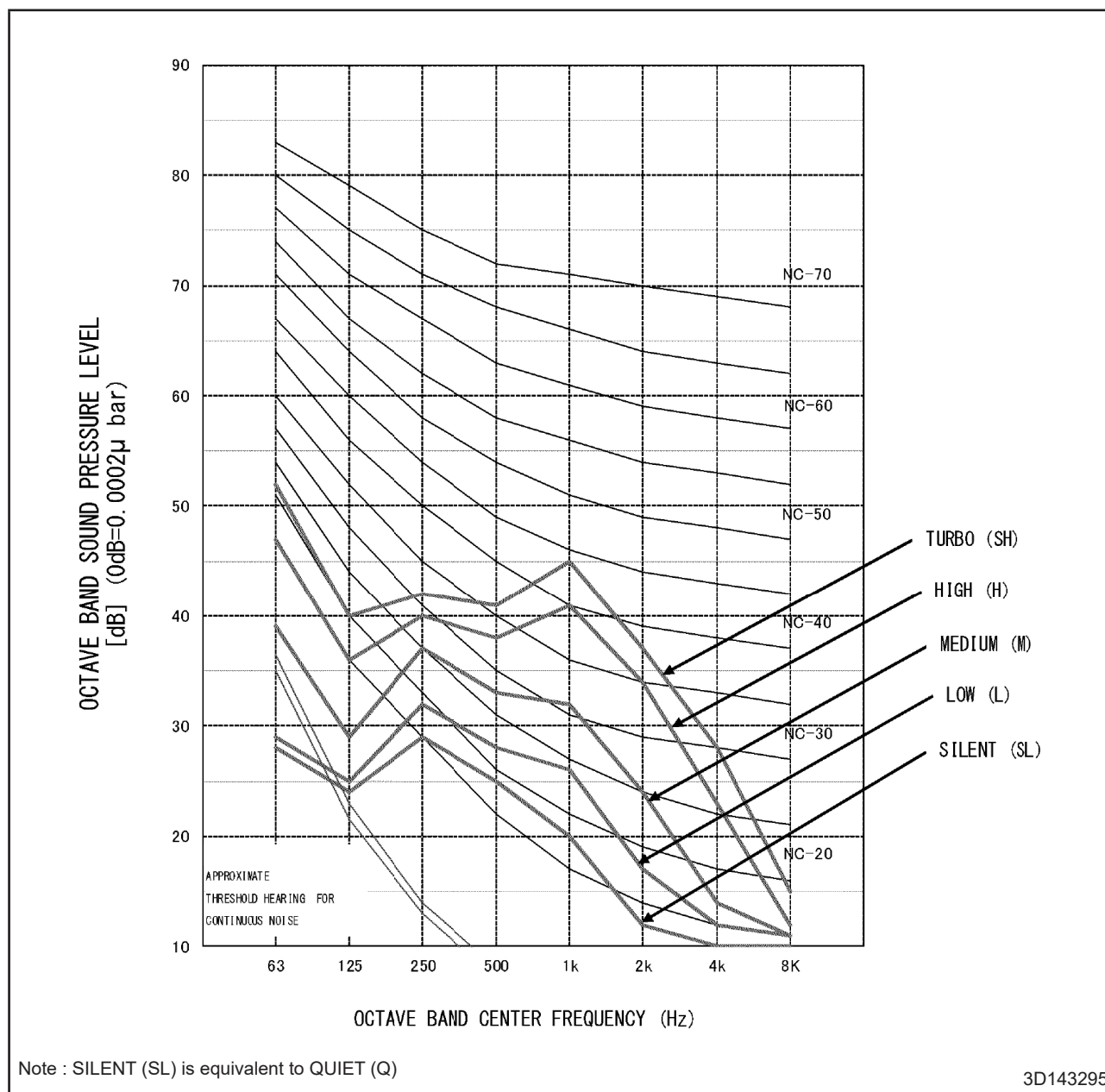

Sound Pressure Level

Model	Speed	1/1 Octave A-weighted Sound Pressure Level (dB, ref 20μPa)								Overall (dBA)	Noise Criteria
		63Hz	125Hz	250Hz	500Hz	1kHz	2kHz	4kHz	8kHz		
FTXB18B (Cooling)	High	51	41	45	43	44	42	35	25	48	43
	Med	41	35	41	39	39	37	29	18	43	38
	Low	34	30	37	34	33	30	21	13	37	32
	Quiet	30	28	34	31	28	23	13	10	33	26

NC Curve

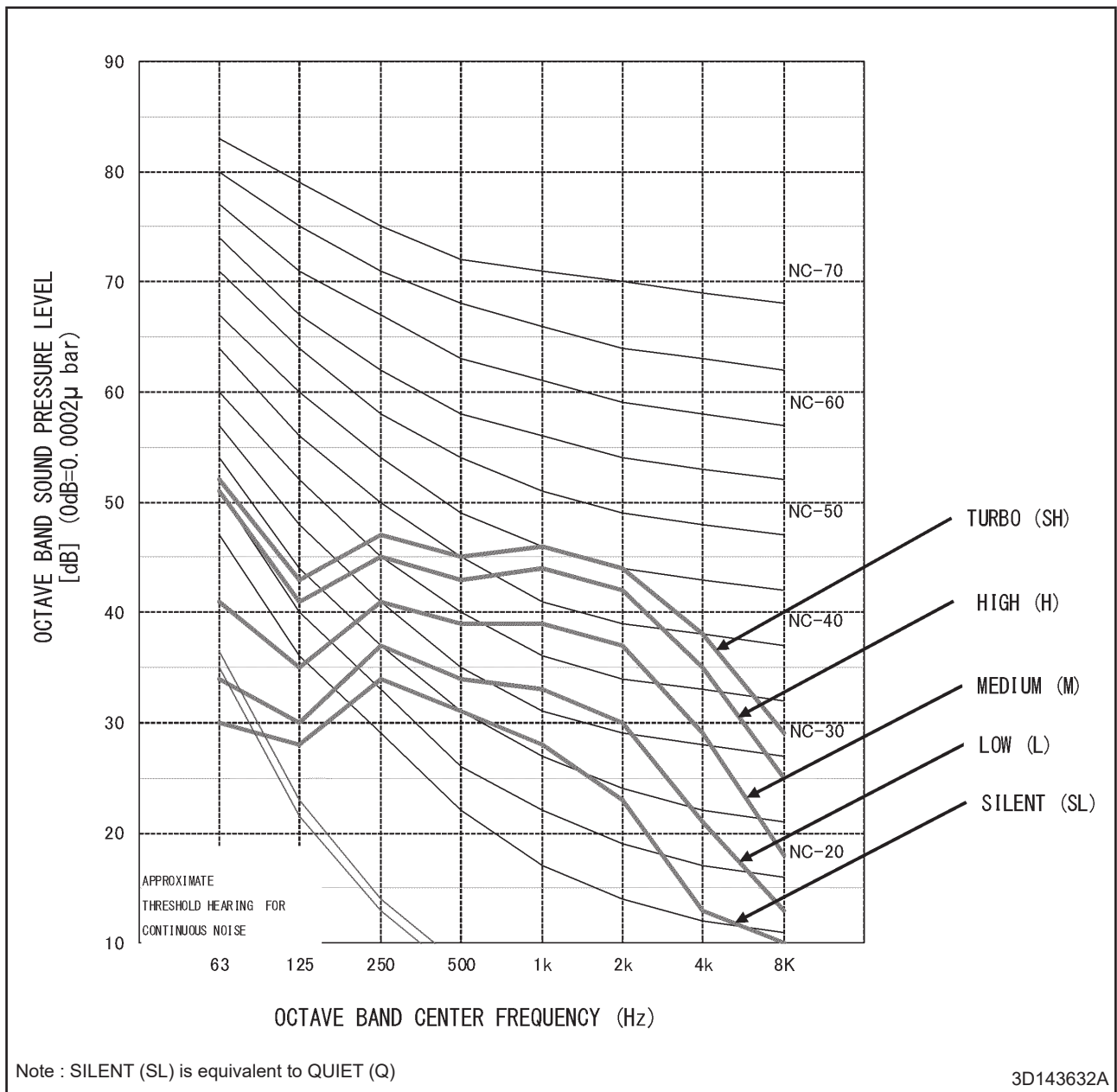

Sound Pressure Level

Model	Speed	1/1 Octave A-weighted Sound Pressure Level (dB, ref 20μPa)								Overall (dBA)	Noise Criteria
		63Hz	125Hz	250Hz	500Hz	1kHz	2kHz	4kHz	8kHz		
FTXB18B (Heating)	High	52	40	43	42	42	39	30	16	46	41
	Med	45	35	39	38	37	34	24	12	41	36
	Low	38	31	38	34	32	25	14	11	36	31
	Quiet	37	29	35	31	29	23	12	10	33	28

NC Curve

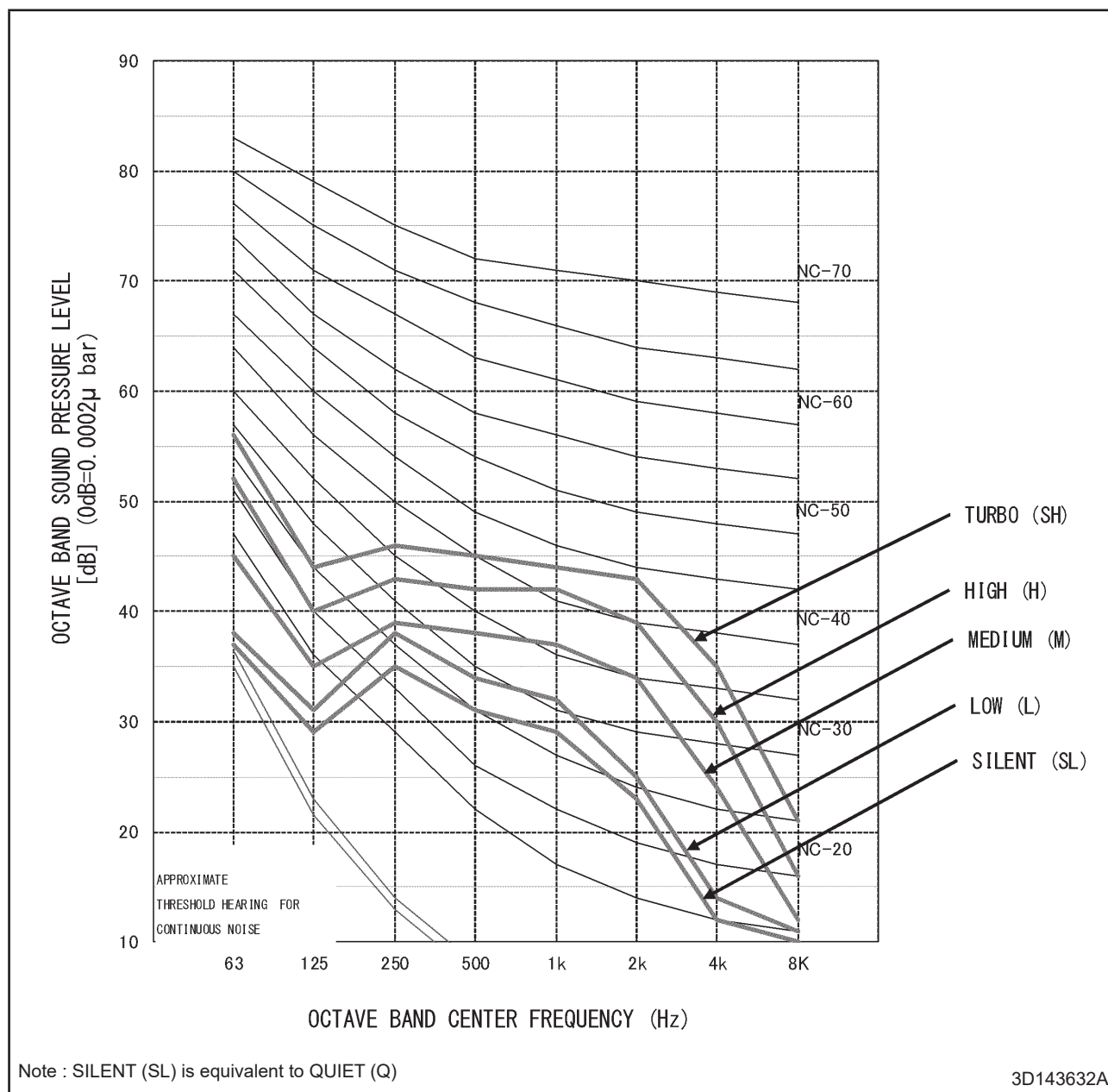

Sound Pressure Level

Model	Speed	1/1 Octave A-weighted Sound Pressure Level (dB, ref 20µPa)								Overall (dBA)	Noise Criteria
		63Hz	125Hz	250Hz	500Hz	1kHz	2kHz	4kHz	8kHz		
FTXB24B (Cooling)	High	51	43	48	46	47	44	37	27	51	46
	Med	42	36	42	40	40	37	29	18	44	39
	Low	35	31	38	35	34	31	21	13	38	33
	Quiet	31	28	35	32	29	24	14	11	34	28

NC Curve

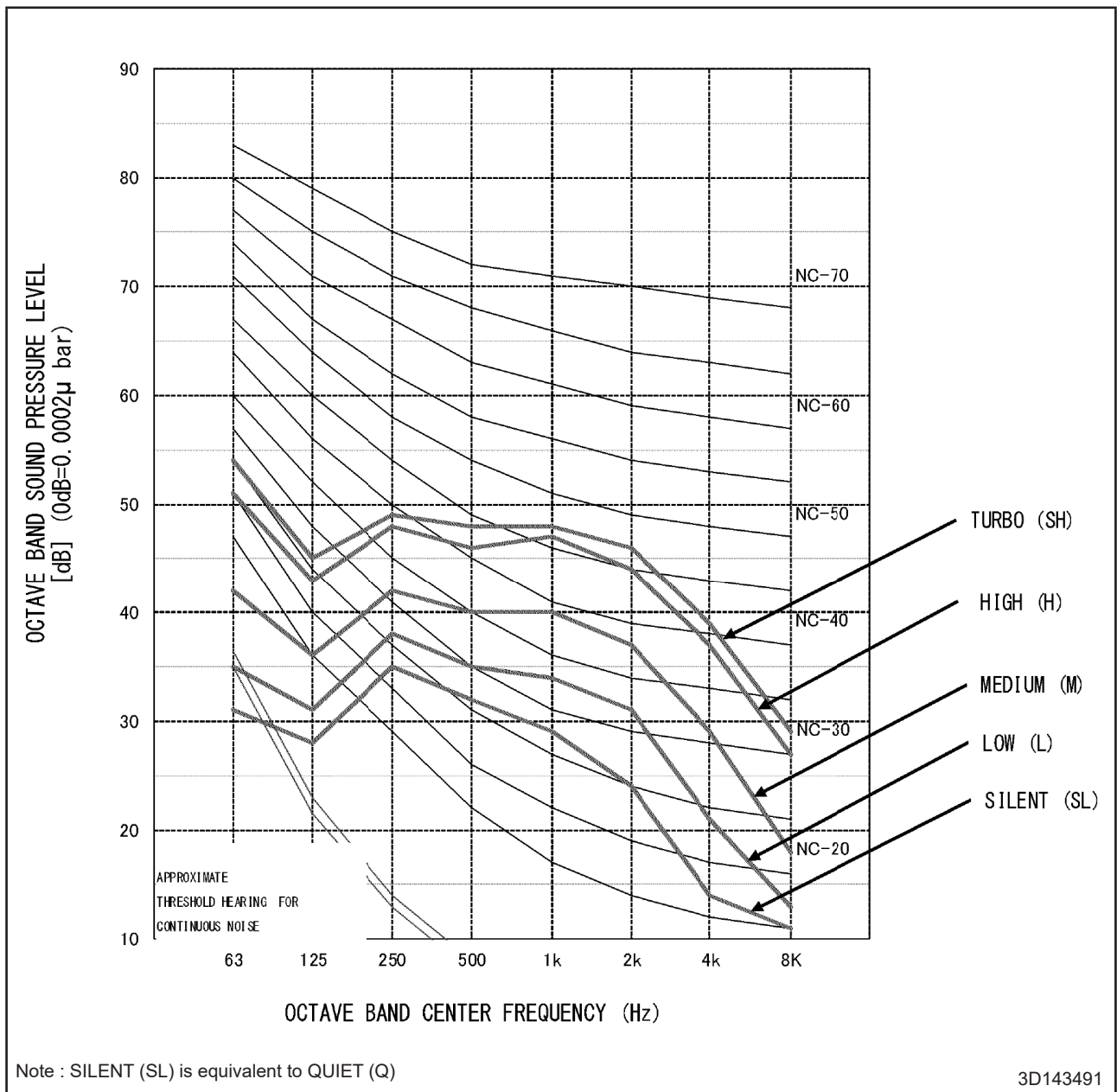

Sound Pressure Level

Model	Speed	1/1 Octave A-weighted Sound Pressure Level (dB, ref 20μPa)								Overall (dBA)	Noise Criteria
		63Hz	125Hz	250Hz	500Hz	1kHz	2kHz	4kHz	8kHz		
FTXB24B (Heating)	High	55	43	45	44	44	41	33	18	48	43
	Med	46	36	40	38	39	35	25	13	42	38
	Low	38	31	38	35	32	26	15	11	37	31
	Quiet	37	29	36	32	30	23	12	10	34	29

NC Curve

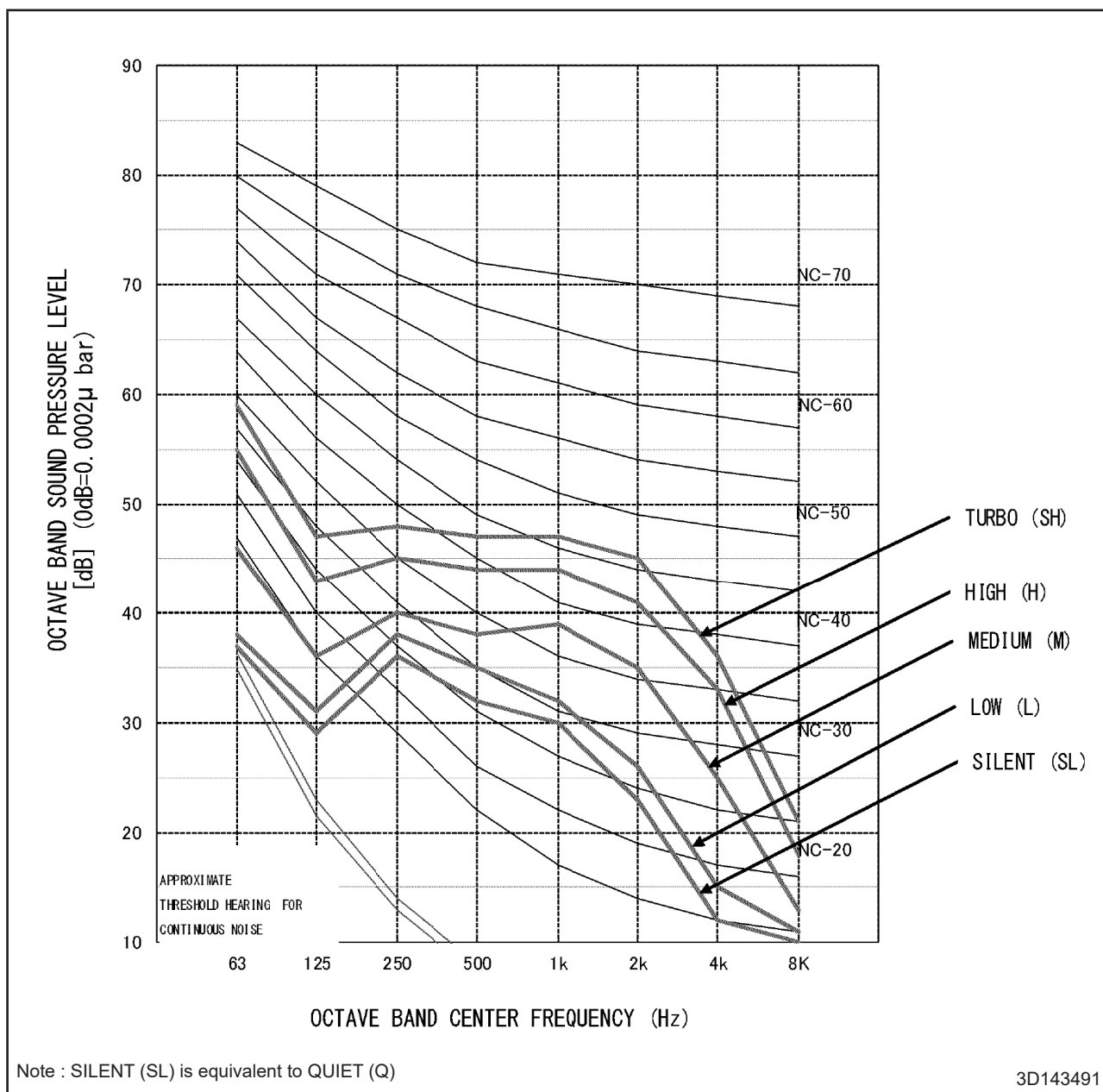

Electric Characteristic

Unit Combination		Power Supply				COMP		OFM		IFM	
Indoor Unit	Outdoor Unit	Hz-Volts	Voltage Range	MCA	MOP	RHz	A	kW	MOC	kW	MOC
FTXB09B	RXB09B	60Hz-208V	MAX. 60Hz 253V MIN. 60Hz 187V	12.35	15	88	4.34	0.026	0.60	0.022	0.35
		60Hz-230V									
FTXB12B	RXB12B	60Hz-208V	MAX. 60Hz 253V MIN. 60Hz 187V	12.40	15	96	5.57	0.026	0.61	0.022	0.40
		60Hz-230V									
FTXB18B	RXB18B	60Hz-208V	MAX. 60Hz 253V MIN. 60Hz 187V	16.55	20	90	8.17	0.055	1.30	0.039	0.55
		60Hz-230V									
FTXB24B	RXB24B	60Hz-208V	MAX. 60Hz 253V MIN. 60Hz 187V	16.55	20	104	10.67	0.055	1.30	0.039	0.55
		60Hz-230V									

Symbols:

MCA	: Minimum Circuit Amps (A)
MOP	: Maximum Overcurrent Protection (A)
COMP	: Compressor
RHz	: Rated Operating Frequency (Hz)
A	: Compressor Input Current (A)
OFM	: Outdoor Fan Motor
IFM	: Indoor Fan Motor
kW	: Fan Motor Rated Output (kW)
MOC	: Maximum Operating Current (A)

Notes:

1. RHz is the max frequency that comes in cooling operation and heating operation.
2. RLA is the max current that comes in cooling operation and heating operation.
3. Maximum allowable voltage that is unbalance between phases is 2%.
4. Select wire size based on the larger value of MCA.
5. Use circuit breaker instead of fuse

3D142347A

Accessories List

	Optional Accessories	Model Number
Indoor Unit	Wired Controller	BRC51D61
	Daikin One+ Smart Thermostat	DTST-ONE-ADA-A
	DKN Residential Cloud Wi-Fi Adaptor	AZAI6WSCDKB
Outdoor Unit	Air Directional Change Grille (Class 09/12)	KPW937F4
	Air Directional Change Grille (Class 18/24)	KPW063B4E
	Drain Pan Heater (Class 09/12)	FTDBHMS, KEH067A41E
	Drain Pan Heater (Class 18/24)	KEH063A4EA
	Outdoor Unit Protection Net Grille (Class 09/12)	KKG067A41
	Outdoor Unit Protection Net Grille (Class 18/24)	-

