

12. Installation Manual

12.1 FTXR

Contents

Safety Considerations	1	Refrigerant Piping Work	9
Accessories	3	1. Flaring the pipe end	10
Choosing an Installation Site	3	2. Refrigerant piping.....	10
1. Indoor unit.....	3	Installation Tips	11
2. Wireless remote controller	3	1. Removing and installing the upper front panel.....	11
Indoor Unit Installation Diagram	4	2. Removing and installing the front grille.....	11
Indoor Unit Installation	5	3. How to set the different addresses	12
1. Installing the mounting plate	5	4. When connecting a wireless LAN connecting adapter.....	12
2. Drilling a wall hole and installing wall embedded pipe... 5		5. When connecting to an HA system.....	13
3. Installing the indoor unit.....	6	Trial Operation and Testing	14
4. Wiring.....	8	1. Trial operation and testing	14
5. Drain piping.....	9	2. Test items	14

The pictures in this document are for illustrative purposes only.

Safety Considerations

Refer also to the General Safety Considerations in the separate booklet.



Read the precautions in this manual carefully before operating the unit.





Read these **Safety Considerations for Installation** carefully before installing an air conditioner or heat pump. After completing the installation, make sure that the unit operates properly during the startup operation.

Instruct the user on how to operate and maintain the unit. Inform users that they should store this installation manual with the operation manual for future reference.

Always use a licensed installer or contractor to install this product. Improper installation can result in water or refrigerant leakage, electric shock, fire, or explosion.

Meanings of **DANGER**, **WARNING**, **CAUTION**, and **NOTE**

Symbols:

-  **DANGER**Indicates an imminently hazardous situation which, if not avoided, will result in death or serious injury.
-  **WARNING**Indicates a potentially hazardous situation which, if not avoided, could result in death or serious injury.
-  **CAUTION**Indicates a potentially hazardous situation which, if not avoided, may result in minor or moderate injury. It may also be used to alert against unsafe practices.
-  **NOTE**Indicates situations that may result in equipment or property damage accidents only.

DANGER

- Refrigerant gas is heavier than air and replaces oxygen. A massive leak can lead to oxygen depletion, especially in basements, and an asphyxiation hazard could occur leading to serious injury or death.
- Do not ground units to water pipes, gas pipes, telephone wires, or lightning rods as incomplete grounding can cause a severe shock hazard resulting in severe injury or death. Additionally, grounding to gas pipes could cause a gas leak and potential explosion causing severe injury or death.

- If refrigerant gas leaks during installation, ventilate the area immediately. Refrigerant gas may produce toxic gas if it comes into contact with fire. Exposure to this gas could cause severe injury or death.
- After completing the installation work, check that the refrigerant gas does not leak throughout the system.
- Do not install unit in an area where flammable materials are present due to risk of explosions that can cause serious injury or death.
- Safely dispose all packing and transportation materials in accordance with federal/state/local laws or ordinances. Packing materials such as nails and other metal or wood parts, including plastic packing materials used for transportation may cause injuries or death by suffocation.

WARNING

- Only qualified personnel licensed or certified in their jurisdiction must carry out the installation work. Installation must be done in accordance with this installation manual. Improper installation may result in water leakage, electric shock, or fire.
- When installing the unit in a small room, take measures to keep the refrigerant concentration from exceeding allowable safety limits. Excessive refrigerant leaks, in the event of an accident in a closed ambient space, can lead to oxygen deficiency.
- Use only specified accessories and parts for installation work. Failure to use specified parts may result in water leakage, electric shock, fire, or the unit falling.
- Install the air conditioner or heat pump on a foundation strong enough that it can withstand the weight of the unit. A foundation of insufficient strength may result in the unit falling and causing injuries.
- Take into account strong winds, typhoons, or earthquakes when installing. Improper installation may result in the unit falling and causing accidents.
- Make sure that a separate power supply circuit is provided for this unit and that all electrical work is carried out by qualified personnel licensed or certified in their jurisdiction according to local, state, and national regulations. An insufficient power supply capacity or improper electrical construction may lead to electric shock or fire.
- Make sure that all wiring is secured, that specified wires are used, and that no external forces act on the terminal connections or wires. Improper connections or installation may result in fire.

- When wiring, position the wires so that the electrical wiring box cover can be securely fastened. Improper positioning of the electrical wiring box cover may result in electric shock, fire, or the terminals overheating.
- Before touching electrical parts, turn off the unit.
- The circuit must be protected with safety devices in accordance with local and national codes, i.e. a circuit breaker.
- Securely fasten the outdoor unit terminal cover (panel). If the terminal cover/panel is not installed properly, dust or water may enter the outdoor unit causing fire or electric shock.
- When installing or relocating the system, keep the refrigerant circuit free from substances other than the specified refrigerant (R410A) such as air. Any presence of air or other foreign substance in the refrigerant circuit can cause an abnormal pressure rise or rupture, resulting in equipment damage and even injury.
- Do not change the setting of the protection devices. If the pressure switch, thermal switch, or other protection device is shorted and operated forcibly, or parts other than those specified by Daikin are used, fire or explosion may occur.
- Do not use means to accelerate the defrosting process (if possible) or to clean, other than those recommended by the manufacturer.
- The appliance must be stored in a room without continuously operating ignition sources (for example: open flames, an operating gas appliance or an operating electric heater).
- Do not pierce or burn.
- Be aware that refrigerants may not contain an odor.
- Comply with national gas regulations.

⚠ CAUTION

- Do not touch the switch with wet fingers. Touching a switch with wet fingers can cause electric shock.
- Do not allow children to play on or around the unit to prevent injury.
- Wear adequate personal protective equipment (protective gloves, safety glasses,...) when installing, maintaining or servicing the system.
- The heat exchanger fins are sharp enough to cut. To avoid injury, wear gloves or cover the fins while working around them.
- Do not touch the refrigerant pipes during and immediately after operation as the refrigerant pipes may be hot or cold, depending on the condition of the refrigerant flowing through the refrigerant piping, compressor, and other refrigerant cycle parts. Your hands may suffer burns or frostbite if you touch the refrigerant pipes. To avoid injury, give the pipes time to return to normal temperature or, if you must touch them, be sure to wear proper gloves.
- Install drain piping to ensure proper drainage. Improper drain piping may result in water leakage and property damage.
- Insulate piping to prevent condensation.
- Be careful when transporting the product.
- Do not turn off the power immediately after stopping operation. Always wait for at least 5 minutes before turning off the power. Otherwise, water leakage may occur.
- Do not use a charging cylinder. Using a charging cylinder may cause the refrigerant to deteriorate.
- Refrigerant R410A in the system must be kept clean, dry, and tight.
 - (a) Clean and Dry -- Foreign materials (including mineral oils such as SUNISO oil or moisture) should be prevented from getting into the system.
 - (b) Tight -- R410A does not contain any chlorine, does not destroy the ozone layer, and does not reduce the earth's protection against harmful ultraviolet radiation. R410A can contribute to the greenhouse effect if it is released. Therefore take proper measures to check for the tightness of the refrigerant piping installation. Read the chapter *Refrigerant Piping Work* and follow the procedures.
- Since R410A is a blend, the required additional refrigerant must be charged in its liquid state. If the refrigerant is charged in a state of gas, its composition can change and the system will not work properly.
- The indoor unit is for R410A. See the catalog for outdoor models that can be connected. Normal operation is not possible when connected to non-compatible outdoor units.
- Remote controller (wireless kit) transmitting distance can be shorter than expected in rooms with electronic fluorescent lamps (inverter or rapid start types). Install the indoor unit far away from fluorescent lamps as much as possible.
- Indoor units are for indoor installation only. Outdoor units can be installed either outdoors or indoors.
- Do not install the air conditioner or heat pump in the following locations:
 - (a) Where a mineral oil mist or oil spray or vapor is produced, for example, in a kitchen. Plastic parts may deteriorate and fall off or result in water leakage.
 - (b) Where corrosive gas, such as sulfurous acid gas, is produced. Corroding copper pipes or soldered parts may result in refrigerant leakage.
 - (c) Near machinery emitting electromagnetic waves. Electromagnetic waves may disturb the operation of the control system and cause the unit to malfunction.
 - (d) Where flammable gas may leak, where there is carbon fiber, or ignitable dust suspension in the air, or where volatile flammables such as thinner or gasoline are handled. Operating the unit in such conditions can cause a fire.
- Take adequate measures to prevent the outdoor unit from being used as a shelter by small animals. Small animals making contact with electrical parts can cause malfunctions, smoke, or fire. Instruct the user to keep the area around the unit clean.
- Servicing shall be performed only as recommended by the manufacturer and licensed or certified in their jurisdiction.











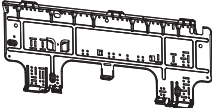

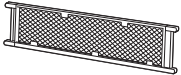
⚠ NOTE

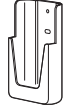
- The indoor unit should be positioned where the unit and inter-unit wires (outdoor to indoor) are at least 3.3ft (1m) away from any televisions or radios. (The unit may cause interference with the picture or sound.) Depending on the radio waves, a distance of 3.3ft (1m) may not be sufficient to eliminate the noise.
- Dismantling the unit, treatment of the refrigerant, oil and additional parts must be done in accordance with the relevant local, state, and national regulations.
- Only use tools for R410A, such as a gauge manifold, charge hose, gas leak detector, reverse flow check valve, refrigerant charge base, vacuum gauge, or refrigerant recovery equipment.
- If the conventional refrigerant and refrigerator oil are mixed in R410A, the refrigerant may deteriorate.
- This air conditioner or heat pump is an appliance that should not be accessible to the general public.
- As maximum allowable pressure is 604psi (4.17MPa), the wall thickness of field-installed pipes should be selected in accordance with the relevant local, state, and national regulations.

FTN005-U

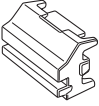
2

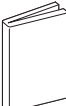
Accessories

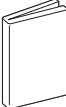
(A) Mounting plate 	1	(B) Mounting plate fixing screw M4 x 1" (M4 x 25mm) 	5	(C) Titanium apatite deodorizing filter 	2
(D) Wireless remote controller 	1	(E) Remote controller holder 	1	(F) Remote controller holder fixing screw M3 x 13/16" (M3 x 20mm) 	2
(G) Dry battery AAA, LR03 (alkaline) 	2	(H) Indoor unit fixing screw M4 x 1/2" (M4 x 12mm) 	2	(J) Screw cover 	2
(K) Insulation tape 	1	(L) Operation manual 	1	(M) Installation manual 	1
(N) Warranty 	1	(P) General safety considerations 	1		

Choosing an Installation Site

Before choosing the installation site, obtain user approval.

1. Indoor unit

- The indoor unit should be positioned in a place where:
 - 1) the restrictions on the installation requirements specified in "Indoor Unit Installation Diagram" on page 4 are met,
 - 2) both the air inlet and air outlet are unobstructed,
 - 3) the unit is not exposed to direct sunlight,
 - 4) Install so that drainage occurs easily,
 - 5) the unit is away from sources of heat or steam,
 - 6) there is no source of machine oil vapor (this may shorten the indoor unit service life),
 - 7) cool/warm air is circulated throughout the room,
 - 8) the unit is away from electronic ignition type fluorescent lamps (inverter or rapid start type) as they may affect the remote controller range,
 - 9) no laundry equipment is nearby.

2. Wireless remote controller

Turn on all the fluorescent lamps in the room, if any, and find a location where the remote controller signals are properly received by the indoor unit (within 19-11/16ft (6m)).

Indoor Unit Installation Diagram

⚠ CAUTION

- Do not hit or violently push the INTELLIGENT EYE sensor. This can lead to damage and malfunction.
- Do not place large objects near the INTELLIGENT EYE sensor. Also keep heating units or humidifiers outside the sensor's detection area.

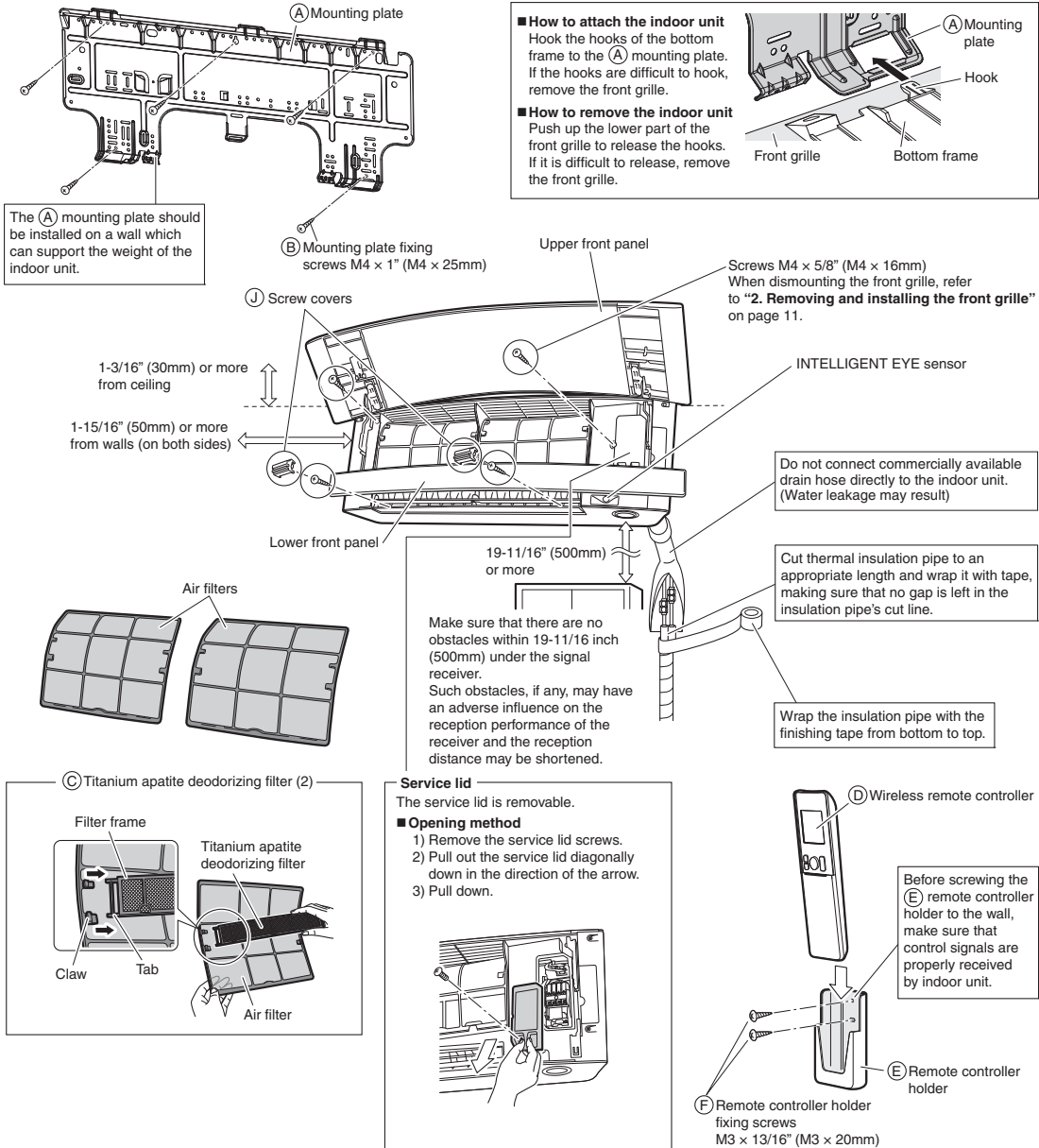

Indoor Unit Installation

1. Installing the mounting plate

The mounting plate should be installed on a wall which can support the weight of the indoor unit.

- 1) Temporarily secure the mounting plate to the wall, make sure that the plate is completely level, and mark the drilling points on the wall.
- 2) Secure the mounting plate to the wall with screws.

Recommended mounting plate retention spots and dimensions

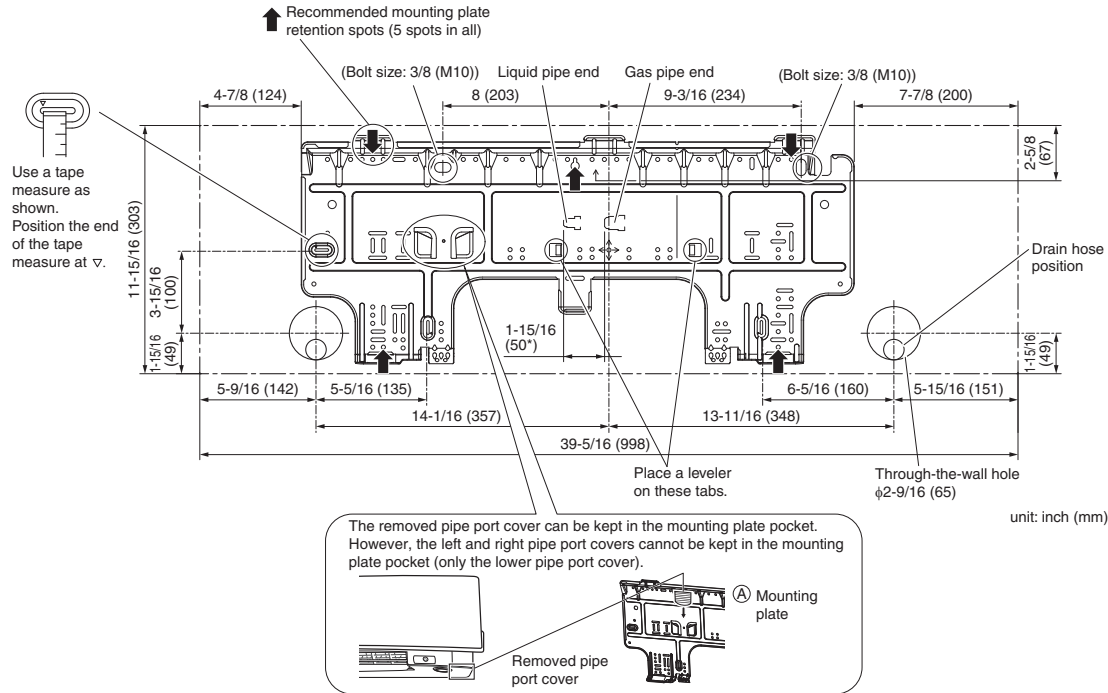

* Depending on the model, the actual distance between the liquid pipe end and gas pipe end may differ from the distance between those symbols on the mounting plate (the distance listed in this manual). Always measure the actual distance between the liquid pipe end and gas pipe end before installing refrigerant pipes.

2. Drilling a wall hole and installing wall embedded pipe

⚠ WARNING

For metal frame or metal board walls, be sure to use a wall embedded pipe and wall hole cover in the feed-through hole to prevent possible heat, electric shock, or fire.

- Be sure to caulk the gaps around the pipes with caulking material. (to prevent condensation caused by intrusion of air from outside or within the wall)
- 1) Drill a feed-through hole with a φ2-9/16 inch (65mm) diameter through the wall at a downward angle toward the outside.
 - 2) Insert a wall embedded pipe into the hole.
 - 3) Insert a wall hole cover into wall pipe.
 - 4) After completing refrigerant piping, wiring, and drain piping, caulk the pipe hole gap with putty.

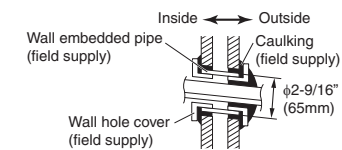

Even if a wall hole cover is not used, caulk both the outdoor and indoor sides with putty.

3. Installing the indoor unit

- The recommended installation method is back piping.
- **When performing bottom piping or left side piping, refer to “3-2. Left-side, left-back, or left-bottom piping”.**
- Right side piping cannot be performed.
- In the case of bending or curing refrigerant pipes, keep the following precautions in mind.
 - Abnormal sound may be generated if improper work is conducted.
 - Do not strongly press the refrigerant pipes onto the bottom frame.
 - Do not strongly press the refrigerant pipes on the front grille, either.

3-1. Right-back or right-bottom piping

- 1) Attach the drain hose to the underside of the refrigerant pipes with adhesive vinyl tape.
- 2) Wrap the refrigerant pipes and drain hose together with (K) insulation tape.
- 3) Pass the drain hose and refrigerant pipes through the wall hole, then position the indoor unit on the (A) mounting plate hooks, using the Δ markings at the top of the indoor unit as a guide.

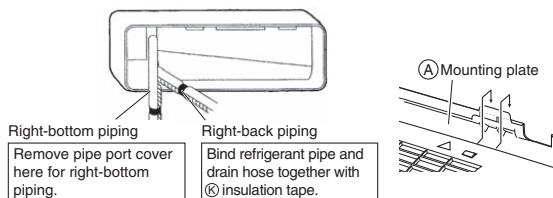

How to remove the pipe port cover

- 1) Cut off the pipe port cover (on the bottom of the front grille) with a coping saw. Apply the blade of the coping saw to the notch, and cut off the pipe port cover along the uneven inner surface.
- 2) After cutting off the pipe port cover, perform filing. Remove the burrs along the cut section using a half round needle file.

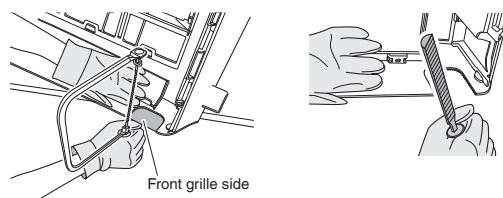

The figure shows the case of left-bottom piping.

NOTE

- Be careful not to let chips enter the driving section of the arm.
- Be careful not to put pressure on the lower front panel.

3-2. Left-side, left-back, or left-bottom piping

- 1) Switch around the drain plug and drain hose.

How to switch around the drain plug and drain hose

- 1) Remove the fixing screw and pull out the drain hose.

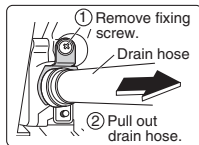

- 2) Pull out drain plug.

- 3) Switch around the drain hose and drain plug.

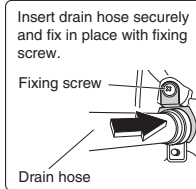
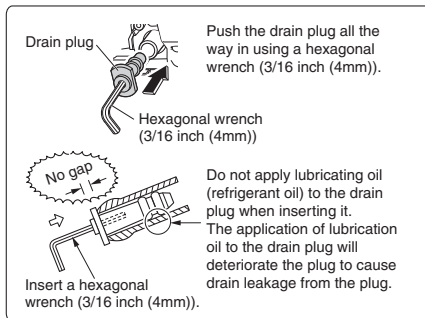

- 2) Attach the drain hose to the underside of the refrigerant pipes with adhesive vinyl tape.
- 3) Shape the refrigerant pipes along the pipe path marking on the (A) mounting plate.

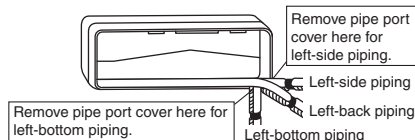

Indoor Unit Installation

How to remove the pipe port cover

- 1) Cut off the pipe port cover with a coping saw.
Apply the blade of the coping saw to the notch, and cut off the pipe port cover along the uneven inner surface.

- **For bottom piping:** On the bottom of the front grille
- **For left side piping:** On the side cover (front grille side and unit side)

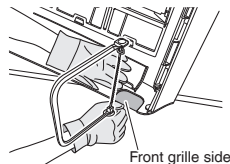

The figure shows the case of left-bottom piping.

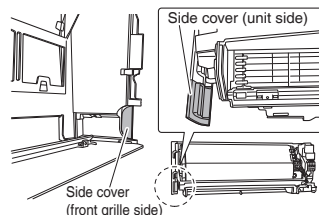

- 2) After cutting off the pipe port cover, perform filing.
Remove the burrs along the cut section using a half round needle file.

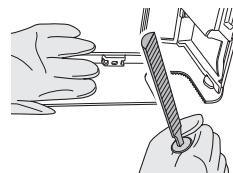

NOTE

- Be careful not to let chips enter the driving section of the arm.
- Be careful not to put pressure on the lower front panel.

- 4) Pass the drain hose and refrigerant pipes through the wall hole, then position the indoor unit on the (A) mounting plate hooks, using the Δ markings at the top of the indoor unit as a guide.

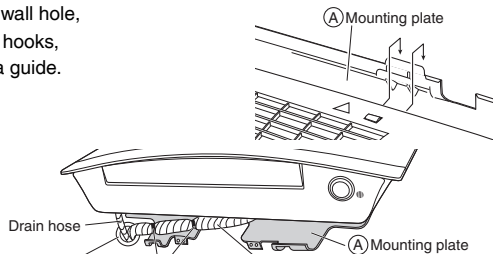

- 5) Connect the refrigerant pipes.
- 6) In case of pulling the drain hose through the back of the indoor unit, wrap the refrigerant pipes and drain hose together with (K) insulation tape as shown in the figure.

Wrap with vinyl tape so that no gap is left and the slit in the thermal insulation pipe is facing upward.

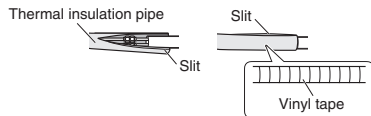

Caulk this hole with putty or caulking material.

Bind with adhesive vinyl tape. If any gap is left or if the refrigerant pipe is bound too tightly, condensation and dripping may result.

Wrap (K) insulation tape from the right end all the way to the left end of the pipe that passes through the back of the indoor unit. Overlap at least half the width of the tape with each turn.

- 7) Press the bottom edge of the indoor unit with both hands until it is firmly caught by the (A) mounting plate hooks. Secure the indoor unit to the (A) mounting plate with the (H) indoor unit fixing screws M4 x 1/2" (M4 x 12mm).

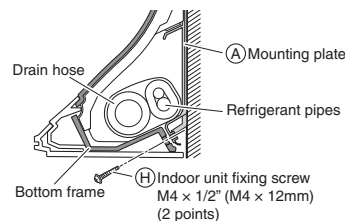

3-3. Wall embedded piping

Follow the instructions given under left-back piping.

- 1) Insert the drain hose to this depth so it won't be pulled out of the drain pipe.

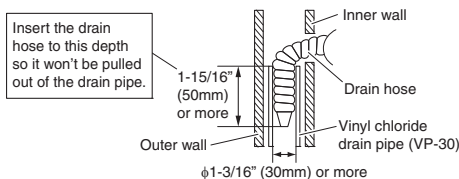

4. Wiring

Refer to the installation manual for the outdoor unit also.

⚠ WARNING

- Do not use tapped wires, extension cords, or starburst connections, as they may cause overheating, electric shock, or fire.
- Do not use locally purchased electrical parts inside the product. (Do not branch the power for the drain pump, etc., from the terminal block.) Doing so may cause electric shock or fire.
- Do not connect the power wire to the indoor unit. Doing so may cause electric shock or fire.

⚠ CAUTION

Recommend stranded cable for interunit wiring. Local code always supersedes recommendation.

- For stranded wires, make sure to use the round crimp-style terminal for connection to the power supply terminal block. Place the round crimp-style terminals on the wires up to the covered part and secure in place.

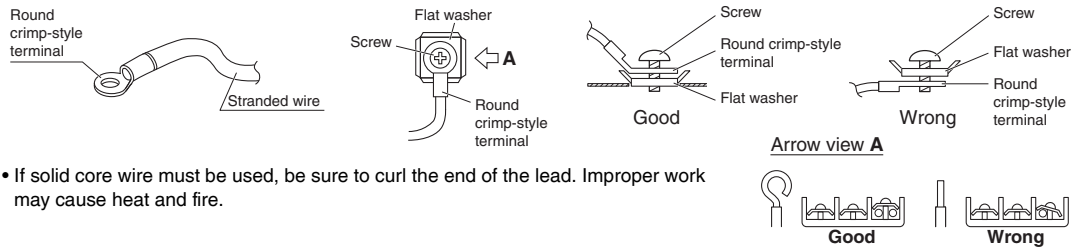

- If solid core wire must be used, be sure to curl the end of the lead. Improper work may cause heat and fire.

With a multi indoor unit , install as described in the installation manual supplied with the multi outdoor unit.

- 1) Remove the upper front panel, then remove the service lid. (Refer to the opening method on page 4.)
- 2) Lift up the unit and place it on the (A) mounting plate hooks.
- 3) Remove the front grille. (Refer to the removal method on page 11.)
- 4) Remove the conduit mounting plate and then secure the conduit to the conduit mounting plate with the lock nut, as shown in the illustration.
- 5) Strip wire ends (3/4 inch (20mm)).
- 6) Match wire colors with terminal numbers on the indoor and outdoor unit's terminal blocks and firmly secure the wires in the corresponding terminals with the screws.
- 7) Connect the ground wire to the corresponding terminals.
- 8) Pull the wires lightly to make sure they are securely connected.

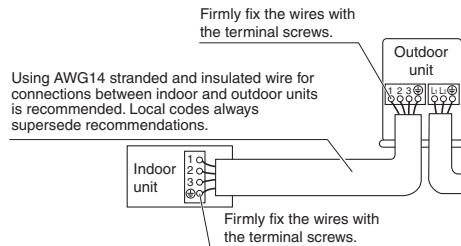
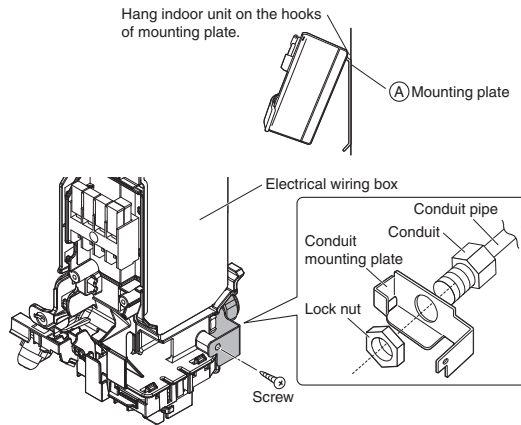
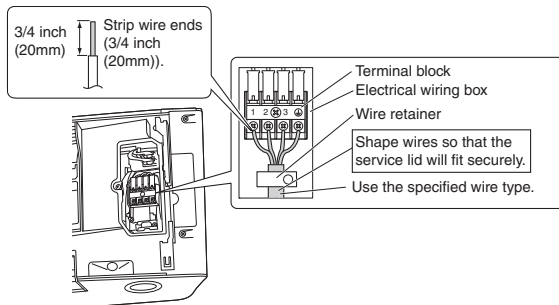

Indoor Unit Installation

- 9) In case of connecting to an adapter system, run the remote controller cable and attach the S21. (Refer to "5. When connecting to an HA system" on page 13.)
- 10) Attach the conduit mounting plate.
- 11) Shape the wires so that the service lid fits securely.
- 12) Attach the front grille. (Refer to removal method on page 11.)
- 13) Attach the service lid and the upper front panel. (Refer to the opening method on page 4.)
- 14) Take care to ensure that all wiring between the indoor unit and the outdoor unit has a consistent connection. Any splices can cause communication errors.

5. Drain piping

- 1) Connect the drain hose, as described on the right.
 - Avoid placing the end of the drain hose in a drainage location that could cause bad odors or corrosive gas to flow backward into the outlet.
 - The drainage water may change color due to bacteria or other organisms. Place in a location where the flow of drainage water will not cause a problem.
 - Minimize the number of bends in the drain hose as much as possible. If bending the drain hose, bend it gently.
- 2) Remove the air filters and transfer some water to the indoor heat exchanger by pouring water into the drain pan.
- 3) Make sure that water flows out of the drain hose.
- 4) If drain hose extension or embedded drain piping is required, use appropriate parts that match the hose front end.

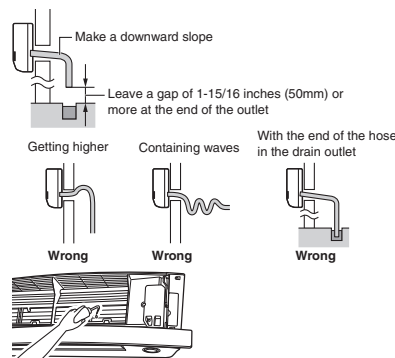
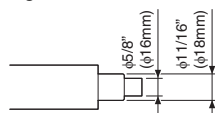
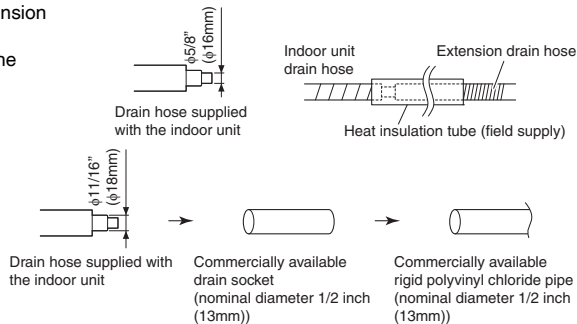

Figure of hose front end



- When drain hose requires extension, obtain an extension hose with an inner diameter of 5/8 inch (16mm). Be sure to thermally insulate the indoor section of the extension hose.
- When connecting a rigid polyvinyl chloride pipe (nominal diameter 1/2 inch (13mm)) directly to the drain hose attached to the indoor unit as with embedded piping work, use any commercially available drain socket (nominal diameter 1/2 inch (13mm)) as a joint.



Refrigerant Piping Work

⚠ WARNING

- Do not apply mineral oil on flared part.
- Prevent mineral oil from getting into the system as this would reduce the service life of the units.
- Never use piping which has been used for previous installations. Only use parts which are delivered with the unit.
- Never install a dryer to this R410A unit in order to guarantee its service life.
- The drying material may dissolve and damage the system.
- Incomplete flaring may result in refrigerant gas leakage.

With a multi indoor unit, install as described in the installation manual supplied with the multi outdoor unit.

1. Flaring the pipe end

- 1) Cut the pipe end with a pipe cutter.
- 2) Remove burrs with the cut surface facing downward, so that the filings do not enter the pipe.



- 3) Put the flare nut on the pipe.
- 4) Flare the pipe.
- 5) Check that the flaring has been done correctly.

Flaring

Set exactly at the position shown below.

	Flare tool for R32 or R410A		Conventional flare tool	
	Clutch-type	Clutch-type (Rigid-type)	Wing-nut type (Imperial-type)	
A	0-0.020 inch (0-0.5mm)	0.039-0.059 inch (1.0-1.5mm)	0.059-0.079 inch (1.5-2.0mm)	

Check

The flare's inner surface must be flaw-free. The pipe end must be evenly flared in a perfect circle.

When flaring, do not over-tighten and crack. Make sure that the flare nut is fitted.

2. Refrigerant piping

CAUTION

- Use the flare nut fixed to the main unit. (This is to prevent the flare nut from cracking as a result of deterioration over time.)
- To prevent gas leakage, apply refrigeration oil only to the inner surface of the flare. (Use refrigeration oil for R410A.)
- Use a torque wrench when tightening the flare nuts to prevent damage to the flare nuts and gas leakage.

- Align the centers of both flares and tighten the flare nuts 3 or 4 turns by hand, then tighten them fully with a spanner and a torque wrench.

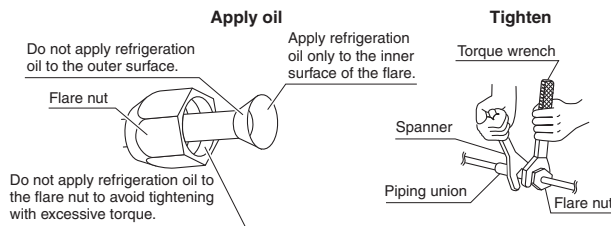

	Piping size	Flare nut tightening torque
Gas side	O.D. 3/8 inch (9.5mm)	24-1/8–29-1/2ft • lbf (32.7-39.9N • m)
	O.D. 1/2 inch (12.7mm)	36-1/2–44-1/2ft • lbf (49.5-60.3N • m)
Liquid side	O.D. 1/4 inch (6.4mm)	10-1/2–12-3/4ft • lbf (14.2-17.2N • m)

2-1. Caution on piping handling

- Protect the open end of the pipe against dust and moisture.
- All pipe bends should be as gentle as possible. Use a pipe bender for bending.

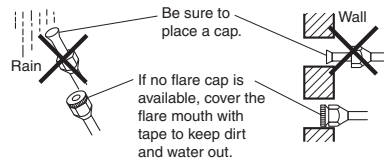

2-2. Selection of copper and heat insulation materials

When using commercial copper pipes and fittings, observe the following:

- Insulation material: Polyethylene foam
Heat transfer rate: 0.041 to 0.052W/mK (0.024 to 0.030Btu/ft²•F (0.035 to 0.045kcal/mh²•C))
Be sure to use insulation that is designed for use with HVAC Systems.
- ACR Copper only.

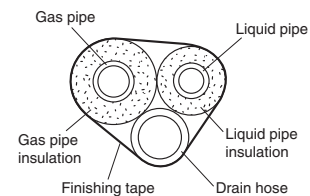

- Be sure to insulate both the gas and liquid piping and observe the insulation dimensions as below.

	Piping size	Minimum bend radius	Piping thickness	Thermal insulation size	Thermal insulation thickness
Gas side	O.D. 3/8 inch (9.5mm)	1-3/16 inch (30mm) or more	0.031 inch (0.8mm) (C1220T-O)	I.D. 15/32-19/32 inch (12-15mm)	13/32 inch (10mm) Min.
	O.D. 1/2 inch (12.7mm)	1-9/16 inch (40mm) or more		I.D. 9/16-5/8 inch (14-16mm)	
Liquid side	O.D. 1/4 inch (6.4mm)	1-3/16 inch (30mm) or more		I.D. 5/16-13/32 inch (8-10mm)	

- Use separate thermal insulation pipes for gas and liquid refrigerant pipes.
- Using finishing tape, bundle and wrap the indoor unit piping and drain hose together so that the drain hose is below the other piping.

Installation Tips

1. Removing and installing the upper front panel

• Removal method

- 1) Open the upper front panel.
- 2) Slide the front panel locks on the back of the front panel upward to release the locks (left and right sides).
- 3) Remove the panel shafts on both sides from the shaft holes, and dismount the upper front panel.

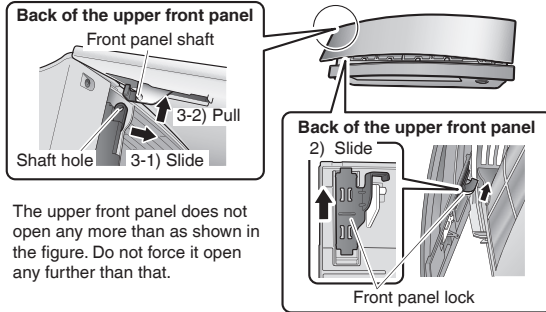

⚠ CAUTION

Do not attempt to push closed the front panel with the upper and lower front panels overlapping. Internal parts may break. (See Fig. 5)
If the front panel must be closed by hand for some reason (remote controller not functioning owing to lack of power supply, etc.), follow the instructions affixed to the indoor unit.

• Installation method

- 1) Slide the front panel locks on the back of the front panel upward to release the locks (left and right sides).
- 2) Insert the panel shafts on both sides of the upper front panel into the shaft holes.
- 3) Slide the front panel locks on each side downward to lock them.
- 4) Close the upper front panel slowly. (See Fig. 1)
- 5) Do not push on the panel to close it. (See Fig. 2)
- 6) Turn on the unit using the remote controller. Wait till the upper and lower front panels are completely open. Then, turn off the unit using the remote controller again. (See Fig. 3)
- 7) Once the both panels close completely, gently push the upper front panel to hook it into position. (See Fig. 4)

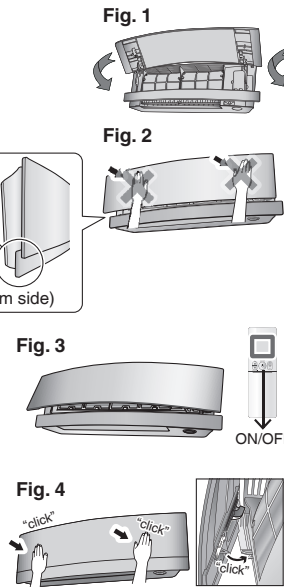

2. Removing and installing the front grille

⚠ CAUTION

Be sure to wear protection gloves.

• Removal method

- 1) Remove the upper front panel and air filters.
- 2) Remove the service lid. (Refer to the opening method on page 4.)
- 3) Disconnect the wire harnesses from the wire clamp, and remove the wire harnesses from the connectors.
- 4) Push the lower front panel up until it stops.
- 5) Dismount the flap (large).
- 6) Open the 2 screw covers, and remove 4 screws from the front grille.
(The screw covers are not factory-mounted.)

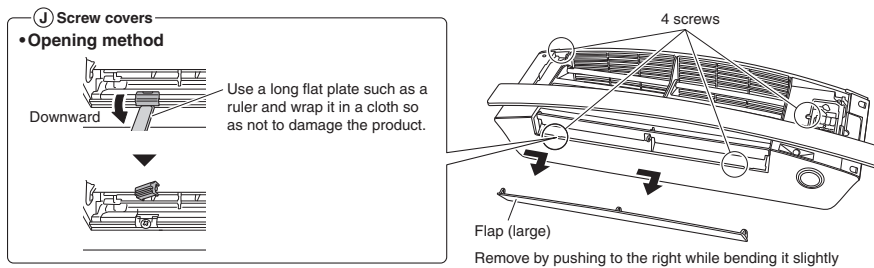
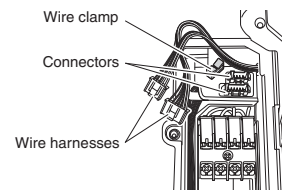

- 7) Wear protection gloves and insert both hands under the front grille as shown in the figure.
- 8) Remove the front grille from the 3 upper hooks by pushing up the top side of the front grille, pull the front grille toward you by holding both ends of the front grille, and dismount the front grille.
 - If the grille is hard to remove, insert a long flat plate* through the gap in the side cover as shown in the figure, and turn the plate inwards to disengage the hooks (3 hooks each on the right and left sides) so that you can remove the grille easily.
 - * Such as a ruler wrapped in a cloth

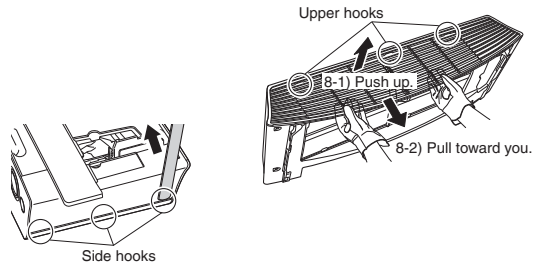

• Installation method

- 1) Install the front grille and firmly engage the upper hooks (3 locations), right and left sides hooks (each 3 locations).
- 2) Install 4 screws of the front grille, and close the 2 screw covers.
- 3) Mount the flap (large).
- 4) Lower the lower front panel to the original position.
- 5) Attach the wire harnesses to the 2 connectors and secure the wire harnesses with the wire clamp.
- 6) Install the air filters and then mount the upper front panel.

3. How to set the different addresses

When 2 indoor units are installed in one room, the 2 wireless remote controllers can be set for different addresses. Change the address setting of one of the two units. When cutting the jumper be careful not to damage any of the surrounding parts.

- 1) Remove the upper front panel and front grille. (Refer to the removal method on page 11.)
- 2) Cut the address jumper (JA) on the printed circuit board.
- 3) Cut the address jumper (J4) in the remote controller.
 - Be careful not to cut jumper (J8).

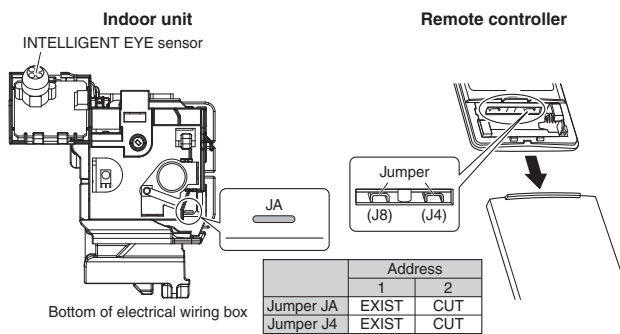

4. When connecting a wireless LAN connecting adapter

• Connection method

- 1) Remove the upper front panel. (Refer to the removal method on page 11.)
- 2) Open the cover, grab the connecting cord with your fingers and pull it out.
- 3) Remove the binding band and pull the insulation tube off the connecting cord.
- 4) Connect the wireless LAN connecting adapter. (For details on connection procedures, refer to the installation manual for the wireless LAN connecting adapter.)
- 5) Place the adapter case into the indoor unit and close the cover.
- 6) Install the upper front panel. (Refer to the installation method on page 11.)

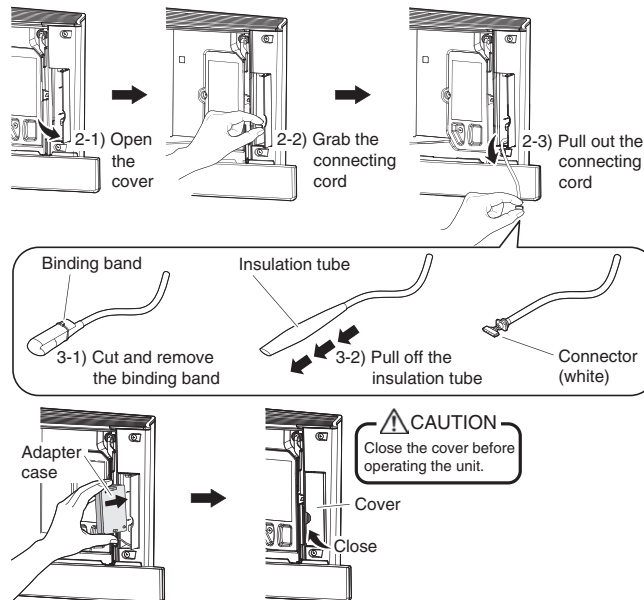

CAUTION
Close the cover before operating the unit.

Installation Tips

5. When connecting to an HA system (wired remote controller, central remote controller etc.)

• Removal methods for metal plate electrical wiring box covers

- 1) Remove the upper front panel and front grille. (Refer to the removal method on page 11.)
- 2) Remove the electrical wiring box. (1 screw)
- 3) Remove the 4 tabs and dismount the metal plate electrical wiring box cover (A).
- 4) Pull down the hook on the metal plate electrical wiring box cover (B), and remove a single tab.
- 5) Remove the 2 tabs on the top part and dismount the metal plate electrical wiring box cover (B).

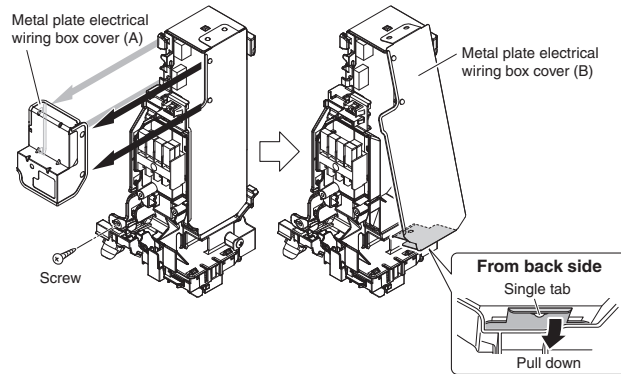

• Attachment methods of connection cord

- 1) Remove the factory-mounted connector from S21.
- 2) Tie the harnesses in a bundle as shown in the figure so that the removed connector does not interfere with the printed circuit board.

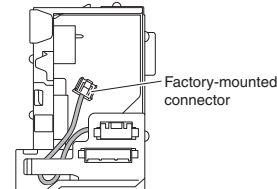

- 3) Attach the connection cord to the S21 connector and pull the harness out through the notched part in the figure.

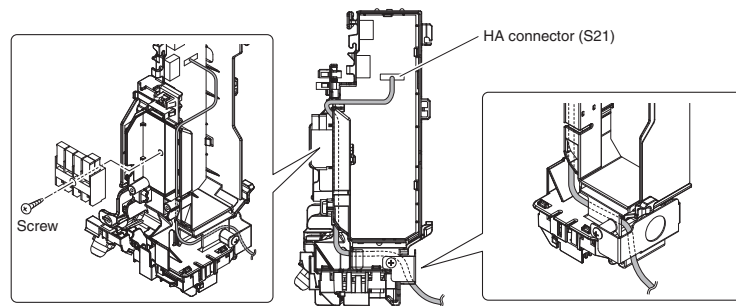

• Attachment methods for metal plate electrical wiring box covers



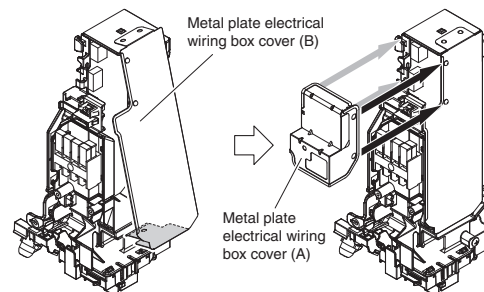



- 1) Hook the top part of the metal plate electrical wiring box cover (B) on the 2 tabs.
- 2) Press in the hook on the bottom to catch a single tab, and mount the metal plate electrical wiring box cover (B).
- 3) Insert the connector into the hole, and hook and mount the metal plate electrical wiring box cover (A) onto the 4 tabs.
- 4) Install the electrical wiring box. (1 screw)
- 5) Install the upper front panel and front grille. (Refer to the installation method on page 11.)



Trial Operation and Testing

1. Trial operation and testing

- Trial operation should be carried out in either COOL or HEAT operation.
- 1-1. Measure the supply voltage and make sure that it is within the specified range.**
- 1-2. In COOL operation, select the lowest programmable temperature; in HEAT operation, select the highest programmable temperature.**
- 1-3. Carry out the trial operation following the instructions in the operation manual to ensure that all functions and parts, such as the movement of the louvers, are working properly.**
 - To protect the air conditioner, restart operation is disabled for 3 minutes after the system has been turned off.
- 1-4. After trial operation is complete, set the temperature to a normal level (78°F to 82°F (26°C to 28°C) in COOL operation, 68°F to 75°F (20°C to 24°C) in HEAT operation).**
- When operating the air conditioner in COOL operation in winter, or HEAT operation in summer, set it to the trial operation mode using the following method.

- 1) Press , , and  at the same time.
- 2) Press , select “7”, and press  for confirmation.
- 3) Press  to turn on the system.



- Trial operation will stop automatically after about 30 minutes. To stop the operation, press .
- Some of the functions cannot be used in the trial operation mode.
- The air conditioner draws a small amount of power in its standby mode. If the system is not to be used for some time after installation, shut off the circuit breaker to eliminate unnecessary power consumption.
- If the circuit breaker trips to shut off the power to the air conditioner, the system will restore the original operation mode when the circuit breaker is opened again.

2. Test items

Test items	Symptom	Check
Indoor and outdoor units are installed securely.	Fall, vibration, noise	
No refrigerant gas leaks.	Incomplete cooling/heating function	
Refrigerant gas and liquid pipes and indoor drain hose extension are thermally insulated.	Water leakage	
Draining line is properly installed.	Water leakage	
System is properly grounded.	Electrical leakage	
Only specified wires are used for all wiring, and all wires are connected correctly.	No operation or burn damage	
Indoor or outdoor unit's air inlet or air outlet are unobstructed.	Incomplete cooling/heating function	
Stop valves are opened.	Incomplete cooling/heating function	
Indoor unit properly receives remote controller commands.	No operation	
 will be displayed when the MODE button is pressed.	No heating	
Pipes and wires are connected to the corresponding terminal blocks/ connection ports for the connected unit.	No cooling/heating	

12.2 FDMQ

Contents

Safety Considerations	1	8. Drain piping work.....	8
Before Installation	3	9. Wiring	11
Accessories	3	10. Duct work	15
Choosing an Installation Site	4	Refrigerant Piping Work	16
Indoor Unit Installation	5	1. Flaring the pipe end.....	16
1. Check the relation of location between the ceiling opening and the indoor unit suspension bolts. (unit: inch (mm))	5	2. Refrigerant piping	16
2. Mount canvas ducts, sound absorbing material and anti-vibration rubber.....	6	Field Settings	18
3. The indoor unit is set to standard external static pressure.....	6	1. Setting remote controller	18
4. Open installation holes (in the case of installation onto the existing ceiling).....	6	2. Settings for external static pressure	18
5. Installing the suspension bolts	6	3. Setting for options.....	19
6. In the case of changing the preset suction to underside suction, replace the chamber cover and the suction flange.....	6	4. Setting air filter sign.....	19
7. Installing the indoor unit	7	5. When implementing group control.....	19
		Trial Operation and Testing	20
		1. Trial operation and testing	20
		2. Test items	21
		3. How to diagnose for malfunction	23
		4. Malfunction code	23

The pictures in this document are for illustrative purposes only.

Safety Considerations

Refer also to the General Safety Considerations in the separate booklet.







Read the precautions in this manual carefully before operating the unit.

Read these **Safety Considerations for Installation** carefully before installing an air conditioner or heat pump. After completing the installation, make sure that the unit operates properly during the startup operation.

Instruct the user on how to operate and maintain the unit. Inform users that they should store this installation manual with the operation manual for future reference.

Always use a licensed installer or contractor to install this product. Improper installation can result in water or refrigerant leakage, electric shock, fire, or explosion.

Meanings of **DANGER**, **WARNING**, **CAUTION**, and **NOTE** Symbols:

-  **DANGER** Indicates an imminently hazardous situation which, if not avoided, will result in death or serious injury.
-  **WARNING** Indicates a potentially hazardous situation which, if not avoided, could result in death or serious injury.
-  **CAUTION** Indicates a potentially hazardous situation which, if not avoided, may result in minor or moderate injury. It may also be used to alert against unsafe practices.
-  **NOTE** Indicates situations that may result in equipment or property damage accidents only.

 **DANGER** _____

- Refrigerant gas is heavier than air and replaces oxygen. A massive leak can lead to oxygen depletion, especially in basements, and an asphyxiation hazard could occur leading to serious injury or death.
- Do not ground units to water pipes, gas pipes, telephone wires, or lightning rods as incomplete grounding can cause a severe shock hazard resulting in severe injury or death. Additionally, grounding to gas pipes could cause a gas leak and potential explosion causing severe injury or death.

- If refrigerant gas leaks during installation, ventilate the area immediately. Refrigerant gas may produce toxic gas if it comes into contact with fire. Exposure to this gas could cause severe injury or death.
- After completing the installation work, check that the refrigerant gas does not leak throughout the system.
- Do not install unit in an area where flammable materials are present due to risk of explosions that can cause serious injury or death.
- Safely dispose all packing and transportation materials in accordance with federal/state/local laws or ordinances. Packing materials such as nails and other metal or wood parts, including plastic packing materials used for transportation may cause injuries or death by suffocation.

 **WARNING** _____

- Only qualified personnel licensed or certified in their jurisdiction must carry out the installation work. Installation must be done in accordance with this installation manual. Improper installation may result in water leakage, electric shock, or fire.
- When installing the unit in a small room, take measures to keep the refrigerant concentration from exceeding allowable safety limits. Excessive refrigerant leaks, in the event of an accident in a closed ambient space, can lead to oxygen deficiency.
- Use only specified accessories and parts for installation work. Failure to use specified parts may result in water leakage, electric shock, fire, or the unit falling.
- Install the air conditioner or heat pump on a foundation strong enough that it can withstand the weight of the unit. A foundation of insufficient strength may result in the unit falling and causing injuries.
- Take into account strong winds, typhoons, or earthquakes when installing. Improper installation may result in the unit falling and causing accidents.
- Make sure that a separate power supply circuit is provided for this unit and that all electrical work is carried out by qualified personnel licensed or certified in their jurisdiction according to local, state, and national regulations. An insufficient power supply capacity or improper electrical construction may lead to electric shock or fire.
- Make sure that all wiring is secured, that specified wires are used, and that no external forces act on the terminal connections or wires. Improper connections or installation may result in fire.

- When wiring, position the wires so that the electrical wiring box cover can be securely fastened. Improper positioning of the electrical wiring box cover may result in electric shock, fire, or the terminals overheating.
- Before touching electrical parts, turn off the unit.
- The circuit must be protected with safety devices in accordance with local and national codes, i.e. a circuit breaker.
- Securely fasten the outdoor unit terminal cover (panel). If the terminal cover/panel is not installed properly, dust or water may enter the outdoor unit causing fire or electric shock.
- When installing or relocating the system, keep the refrigerant circuit free from substances other than the specified refrigerant (R410A) such as air. Any presence of air or other foreign substance in the refrigerant circuit can cause an abnormal pressure rise or rupture, resulting in equipment damage and even injury.
- Do not change the setting of the protection devices. If the pressure switch, thermal switch, or other protection device is shorted and operated forcibly, or parts other than those specified by Daikin are used, fire or explosion may occur.
- Do not use means to accelerate the defrosting process (if possible) or to clean, other than those recommended by the manufacturer.
- The appliance must be stored in a room without continuously operating ignition sources (for example: open flames, an operating gas appliance or an operating electric heater).
- Do not pierce or burn.
- Be aware that refrigerants may not contain an odor.
- Comply with national gas regulations.

CAUTION

- Do not touch the switch with wet fingers. Touching a switch with wet fingers can cause electric shock.
- Do not allow children to play on or around the unit to prevent injury.
- Wear adequate personal protective equipment (protective gloves, safety glasses,...) when installing, maintaining or servicing the system.
- The heat exchanger fins are sharp enough to cut. To avoid injury, wear gloves or cover the fins while working around them.
- Do not touch the refrigerant pipes during and immediately after operation as the refrigerant pipes may be hot or cold, depending on the condition of the refrigerant flowing through the refrigerant piping, compressor, and other refrigerant cycle parts. Your hands may suffer burns or frostbite if you touch the refrigerant pipes. To avoid injury, give the pipes time to return to normal temperature or, if you must touch them, be sure to wear proper gloves.
- Install drain piping to ensure proper drainage. Improper drain piping may result in water leakage and property damage.
- Insulate piping to prevent condensation.
- Be careful when transporting the product.
- Do not turn off the power immediately after stopping operation. Always wait for at least 5 minutes before turning off the power. Otherwise, water leakage may occur.
- Do not use a charging cylinder. Using a charging cylinder may cause the refrigerant to deteriorate.
- Refrigerant R410A in the system must be kept clean, dry, and tight.

- (a) Clean and Dry -- Foreign materials (including mineral oils such as SUNISO oil or moisture) should be prevented from getting into the system.

- (b) Tight -- R410A does not contain any chlorine, does not destroy the ozone layer, and does not reduce the earth's protection against harmful ultraviolet radiation. R410A can contribute to the greenhouse effect if it is released. Therefore take proper measures to check for the tightness of the refrigerant piping installation. Read the chapter *Refrigerant Piping Work* and follow the procedures.
- Since R410A is a blend, the required additional refrigerant must be charged in its liquid state. If the refrigerant is charged in a state of gas, its composition can change and the system will not work properly.
- The indoor unit is for R410A. See the catalog for outdoor models that can be connected. Normal operation is not possible when connected to non-compatible outdoor units.
- Remote controller (wireless kit) transmitting distance can be shorter than expected in rooms with electronic fluorescent lamps (inverter or rapid start types). Install the indoor unit far away from fluorescent lamps as much as possible.
- Indoor units are for indoor installation only. Outdoor units can be installed either outdoors or indoors.
- Do not install the air conditioner or heat pump in the following locations:
 - (a) Where a mineral oil mist or oil spray or vapor is produced, for example, in a kitchen. Plastic parts may deteriorate and fall off or result in water leakage.
 - (b) Where corrosive gas, such as sulfurous acid gas, is produced. Corroding copper pipes or soldered parts may result in refrigerant leakage.
 - (c) Near machinery emitting electromagnetic waves. Electromagnetic waves may disturb the operation of the control system and cause the unit to malfunction.
 - (d) Where flammable gas may leak, where there is carbon fiber, or ignitable dust suspension in the air, or where volatile flammables such as thinner or gasoline are handled. Operating the unit in such conditions can cause a fire.
- Take adequate measures to prevent the outdoor unit from being used as a shelter by small animals. Small animals making contact with electrical parts can cause malfunctions, smoke, or fire. Instruct the user to keep the area around the unit clean.
- Servicing shall be performed only as recommended by the manufacturer and licensed or certified in their jurisdiction.

NOTE

- The indoor unit should be positioned where the unit and inter-unit wires (outdoor to indoor) are at least 3.3ft (1m) away from any televisions or radios. (The unit may cause interference with the picture or sound.) Depending on the radio waves, a distance of 3.3ft (1m) may not be sufficient to eliminate the noise.
- Dismantling the unit, treatment of the refrigerant, oil and additional parts must be done in accordance with the relevant local, state, and national regulations.
- Only use tools for R410A, such as a gauge manifold, charge hose, gas leak detector, reverse flow check valve, refrigerant charge base, vacuum gauge, or refrigerant recovery equipment.
- If the conventional refrigerant and refrigerator oil are mixed in R410A, the refrigerant may deteriorate.
- This air conditioner or heat pump is an appliance that should not be accessible to the general public.
- As maximum allowable pressure is 604psi (4.17MPa), the wall thickness of field-installed pipes should be selected in accordance with the relevant local, state, and national regulations.

FTN005-U















Before Installation

- Leave the unit inside its packaging until you reach the installation site. Where unpacking is unavoidable, use a sling of soft material or protective plates together with a rope when lifting, this to avoid damage or scratches to the unit. When unpacking the unit or when moving the unit after unpacking, be sure to lift the unit by holding on to the hanger bracket without exerting any pressure on other parts, especially on refrigerant piping, drain piping and other resin parts.
- Refer to the installation manual of the outdoor unit for items not described in this manual.
- Caution concerning refrigerant series R410A:
The connectable outdoor units must be designed exclusively for R410A.

Precautions

- Do not install or operate the unit in places mentioned below.
 - Places with mineral oil, or filled with oil vapor or spray like in kitchens. (Plastic parts may deteriorate.)
 - Where corrosive gas like sulphurous gas exists. (Copper tubing and brazed spots may corrode.)
 - Where volatile flammable gas like thinner or gasoline is used.
 - Where machines generating electromagnetic waves exist. (Control system may malfunction.)
 - Where the air contains high levels of salt such as near the ocean and where voltage fluctuates a lot (e.g. in factories). Also inside vehicles or vessels.
- Do not install accessories on the casing directly. Drilling holes in the casing may damage electrical wires and consequently cause fire.
- Take off static electricity from the body when carrying out wiring and the electrical wiring box cover is removed. The electric parts may be damaged.

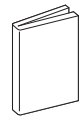
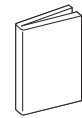
Accessories

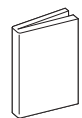
<p>(A) Clamp metal</p>  <p>1</p>	<p>(B) Drain hose</p>  <p>1</p>	<p>(C) Duct flange connection screw</p>  <p>10*</p>	<p>(D) Fitting insulation (for liquid pipe)</p>  <p>Thin</p> <p>1</p>
<p>(E) Fitting insulation (for gas pipe)</p>  <p>Thick</p> <p>1</p>	<p>(F) Sealing pad (large) (Dark gray)</p>  <p>1</p>	<p>(G) Sealing pad (medium) (Dark gray)</p>  <p>2</p>	<p>(H) Clamp</p>  <p>8</p>
<p>(J) Washer fixing plate</p>  <p>4</p>	<p>(K) Wire sealing pad (small) (Gray)</p>  <p>2</p>	<p>(L) Washer (for hanger bracket)</p>  <p>8</p>	<p>(M) Conduit mounting plate</p>  <p>1</p>
<p>(N) Operation manual</p>  <p>1</p>	<p>(P) Installation manual</p>  <p>1</p>	<p>(Q) Warranty</p>  <p>1</p>	<p>(R) General safety considerations</p>  <p>1</p>

*The 15/18/24 class models have 18 screws.

Optional Accessories

A remote controller is required for the indoor unit.

- There are 2 types of remote controllers: wired and wireless. Select a remote controller from the table according to user request and install in an appropriate place.

Remote controller type	Model name
Wired type	BRC1E73
Wireless type	BRC082A43

- If you wish to use a remote controller that is not listed in the table, select a suitable remote controller after consulting catalogs and technical materials.
- The indoor unit can be switched to lower suction. (Refer to “6. In the case of changing the preset suction to underside suction, replace the chamber cover and the suction flange.” (page 6))
The side cover plate (KDBD63A160) is required in the case of wiring from the bottom for underside suction. For installation work, refer to the instruction sheet provided with the side cover plate.

Choosing an Installation Site

Hold the unit by the 4 hanger brackets when opening the box and moving it, and do not exert pressure on to any other part, piping (refrigerant, drain, etc.), and air outlet flange.

If the temperature or humidity inside the ceiling might rise above 86°F (30°C) or RH 80%, respectively, add extra insulation to the unit.

Use polyethylene foam as insulation and make sure it is at least 3/8 inch (10mm) thick and fits inside the ceiling opening.

- Before choosing the installation site, obtain user approval.
The indoor unit should be positioned in a place where:
 - 1) both the air inlet and air outlet are unobstructed,
 - 2) the unit is not exposed to direct sunlight,
 - 3) the unit is away from the source of heat or steam,
 - 4) there is no source of machine oil vapor (this may shorten the indoor unit service life),
 - 5) cool/warm air is circulated throughout the room,
 - 6) the unit is away from electronic ignition type fluorescent lamps (inverter or rapid start type) as they may affect the remote controller range,
 - 7) no laundry equipment is nearby,
 - 8) drainage can be performed without any problem,
 - 9) the weight of the indoor unit can be adequately supported,
 - 10) the wall and the ceiling's lower surface are not significantly tilted,
 - 11) room can be left for installation and service work,
 - 12) there is no risk of flammable gas leaking,
 - 13) the required length of indoor-outdoor piping would not exceed the specified maximum length (see the installation manual that came with the outdoor unit for details).

[Installation Space Requirements]

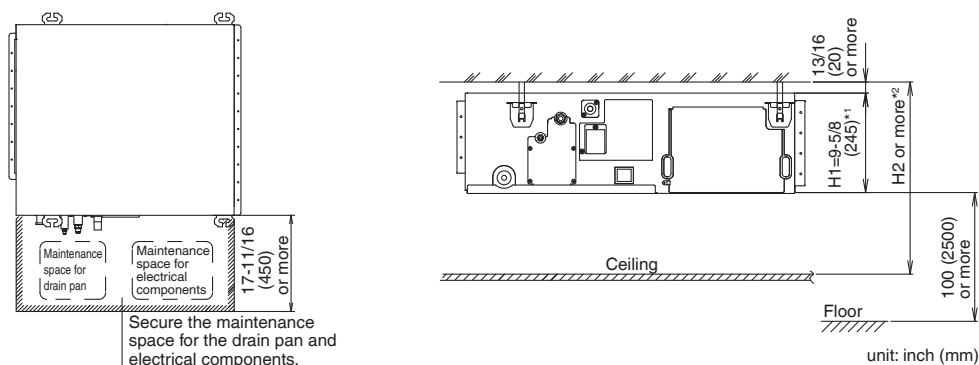

*1 Dimension H1 indicates the product height.

*2 Secure a downward slope of at least 1/100 specified in "8. Drain piping work" (page 8) and determine dimension H2.

<Failure example>

If there is an obstacle in the airflow path or proper installation space is not provided, the indoor unit will cause air volume reduction and take in air blown out of the indoor unit, thus resulting in performance degradation or turning the thermostat OFF frequently.

Use suspension bolts for installation. Check whether the ceiling is strong enough to support the weight of the unit or not. If there is a risk, reinforce the ceiling before installing the unit.

Indoor Unit Installation

1. Check the relation of location between the ceiling opening and the indoor unit suspension bolts. (unit: inch (mm))

Provide one of the following service spaces for the maintenance and inspection of the electrical wiring box and drain pump or for other services.

If a space of 300mm or more under the product can be secured

- Inspection ports 1 and 2 (17-11/16 inch (450mm) × 17-11/16 inch (450mm)) and a minimum space of 11-13/16 inch (300mm) at the bottom of the product.

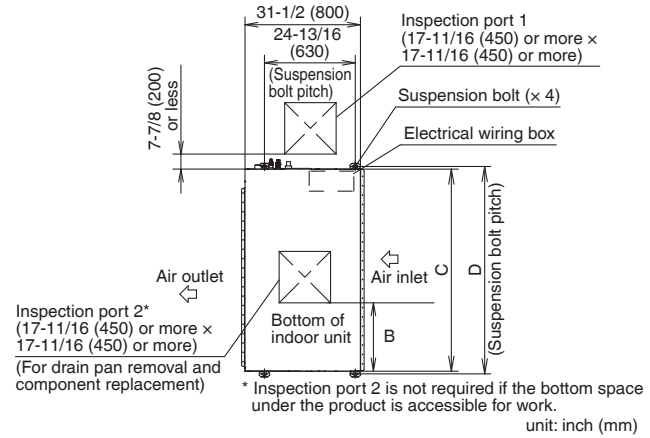
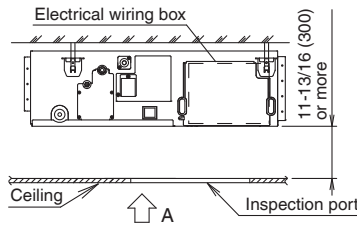

View A

If a space of 300mm or more under the product can not be secured

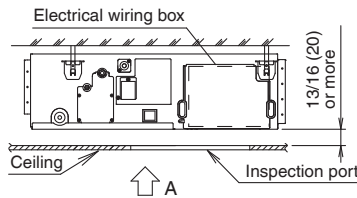

- 1) Inspection port 1 (17-11/16 inch (450mm) × 17-11/16 inch (450mm)) on the electrical wiring box side and inspection port 2 on the bottom of the product. (View A-1))

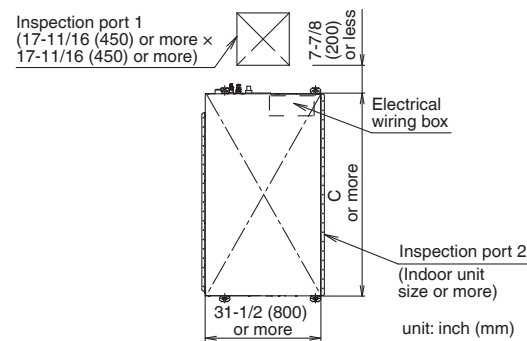

View A-1)

- 2) Inspection port 3 on the bottom of the product and on the bottom side of the electrical wiring box. (View A-2))

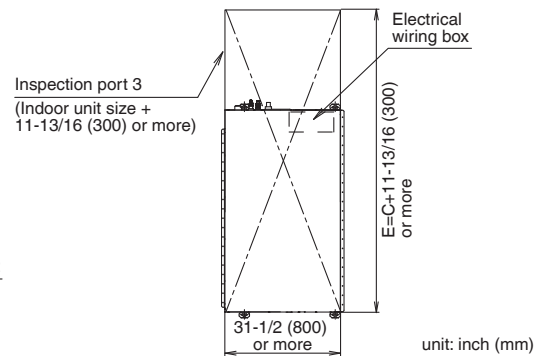

View A-2)

	B	C	D	E
07/09/12 class	(0)	27-9/16 (700)	29-1/16 (738)	39-3/8 (1000)
15/18/24 class	1-15/16 (50)	39-3/8 (1000)	40-7/8 (1038)	51-3/16 (1300)

unit: inch (mm)

2. Mount canvas ducts, sound absorbing material and anti-vibration rubber.

- Mount canvas ducts to the air outlet and inlet so that the vibration of the indoor unit will not be transmitted to the ducts or ceiling.
Furthermore, attach sound absorbing material (thermal insulation material) to the duct inner walls and anti-vibration rubber to the suspension bolts (refer to “10. Duct work” (page 15)).

3. The indoor unit is set to standard external static pressure.

- If external static pressure is higher or lower than the standard set value, the remote controller may be used to make on-site setting change in the external static pressure.
Refer to “Field settings” (page 18).

4. Open installation holes (in the case of installation onto the existing ceiling).

- Open the installation holes on the ceiling of the installation location, and work on the refrigerant piping, drain piping, remote controller wiring, and wiring between the indoor and outdoor units to the piping connection port and wiring connection port of the indoor unit (refer to each piping and wiring procedure items).
- Ceiling framework reinforcement may be required in order to keep the ceiling horizontal and prevent ceiling vibration after opening the ceiling holes. For details, consult your building and upholstery work contractors.

5. Installing the suspension bolts

(Use either a M8-M10 size bolt or the equivalent)
Use a hole-in anchor for existing ceilings, and a sunken insert, sunken anchor or other field supplied parts for new ceilings to reinforce the ceiling to bear the weight of the unit.
Adjust clearance (2-4 inch (50-100mm)) from the ceiling before proceeding further.

- All the above parts are field supplied.

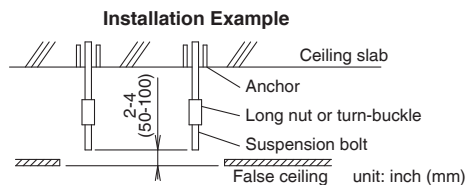

6. In the case of changing the preset suction to underside suction, replace the chamber cover and the suction flange.

1. Remove the suction flange and chamber cover.
2. Replace the suction flange and the chamber cover.

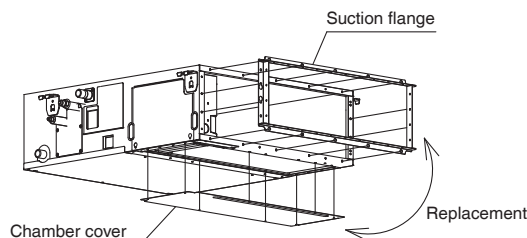

⚠ CAUTION

- Secure a sufficient maintenance space for the drain pan and electrical components before installing the indoor unit.
- Secure a sufficient maintenance space for the filter chamber, and peripheral components before installing the indoor unit.

Indoor Unit Installation

7. Installing the indoor unit

When installing optional accessories, read also the installation manual of the optional accessories. Depending on the field conditions, it may be easier to install optional accessories before the indoor unit is installed.

As for the parts to be used for installation work, be sure to use the provided accessories and specified parts designated by Daikin.

1) Install the indoor unit temporarily.

- Attach the hanger bracket to the suspension bolt. Be sure to fix it securely by using a nut and (L) washer from the upper and lower sides of the hanger bracket.

If the (J) washer fixing plate is used, the upper side (L) washer may be protected from falling off.

Securing the hanger bracket

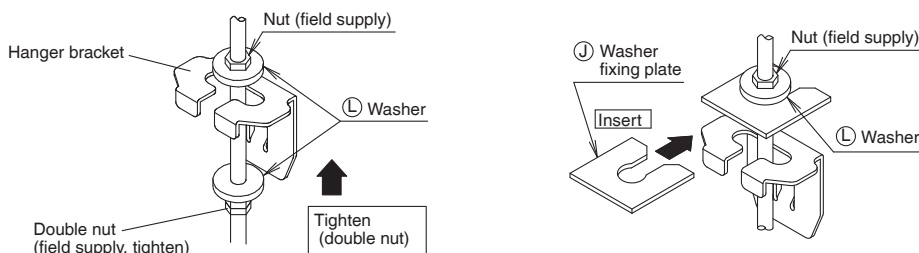

- Keep the air outlet covered with a protective sheet to prevent weld spatter and other foreign materials from entering the indoor unit and damaging the resin drain pan.
(If holes or cracks are generated in the resin drain pan, water can leak.)

2) Adjust the height of the unit.

3) Check the unit is horizontally level.

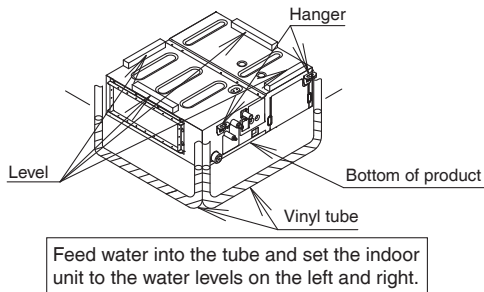

4) Remove the (J) washer fixing plate used for preventing the (L) washer from dropping and tighten the upper side nut.

⚠ CAUTION

- **Install the indoor unit leveled.**

If the indoor unit is inclined and the drain piping side gets high, it may cause malfunction of float switch and result in water leakage.

- **Attach nuts on the upper and lower side of hanger.**

If there is no upper nut and the lower nut is over-tightened, the hanger and the top plate will deform and cause abnormal sound.

- **Do not insert materials other than that specified into the clearance between the hanger and the washer for hanger bracket (11).**
Unless the washers are properly attached, the suspension bolts may come off from the hanger.

⚠ WARNING

The indoor unit must be securely installed on a place that can withstand the mass.

If the strength is insufficient, the indoor unit may fall down and cause injuries.

8. Drain piping work

⚠ CAUTION

- Water pooling in the drainage piping can cause the drain to clog.
- Do not connect the drain piping directly to sewage pipes that smell of ammonia. The ammonia in the sewage might enter the indoor unit through the drain pipes and corrode the heat exchanger.
- Keep in mind that the drain pipe becomes blocked if water collects on it.
- Do not tighten the (A) clamp metal with the torque more than the specified value. The (B) drain hose, the socket or the (A) clamp metal may be damaged.

1. Install of drain piping

- Install the drain piping as shown in the figure and take measures against condensation. Improperly rigged piping could lead to leaks and eventually wet furniture and belongings.
- Keep piping as short as possible and slope it downwards at a gradient of at least 1/100 so that air may not remain trapped inside the pipe.
- Select the piping diameter equal to or larger than (except for riser) that of the connection piping (polyvinyl chloride piping, nominal diameter 1 inch (25mm), outside diameter 1-1/4 inch (32mm)).
- If the drain hose cannot be sufficiently set on a slope, refer to “Precautions for drain raising piping” (page 9).
- To keep the drain hose from sagging, space hanger bracket every 40-60 inch (1000-1500mm).

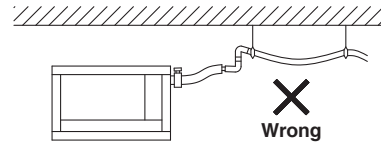
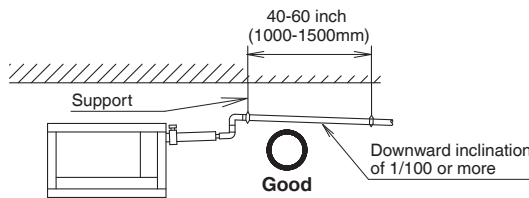

- Make sure to use the attached (B) drain hose and the (A) clamp metal. Insert the (B) drain hose into the drain socket up to the point where the socket diameter becomes larger. Put the (A) clamp metal to the taped hose end and tighten the (A) clamp metal with torque 10.6~13.3lbf • ft (120~150 N•cm).

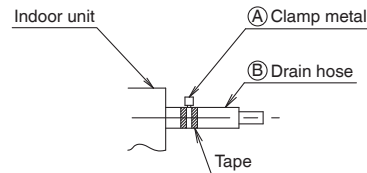

- Wrap the vinyl tape around the end of the (A) clamp metal so that the (F) sealing pad (Large) to be used at the next process may not be damaged with the clamp end or bend the tip of the (A) clamp metal inward as shown.

<In case of sticking vinyl tape>

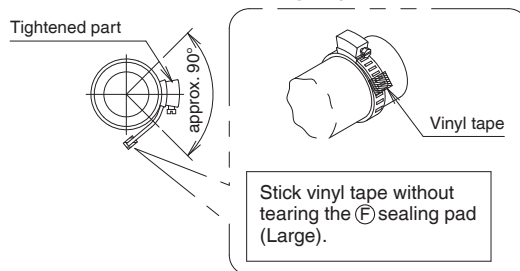

<In case of bending the tip>

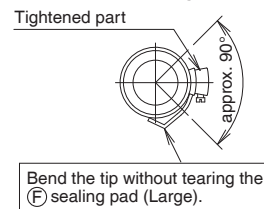

Indoor Unit Installation

Precautions for drain raising piping

- The maximum height of the drain riser is 29-9/16 inch (675mm). Since the drain pump mounted on this indoor unit is a high head type, from the characteristic point of view, the higher the drain riser the lower the draining noise. Therefore, the drain riser of 11-13/16 inch (300mm) or higher is recommended.
- For upward drain piping, keep the horizontal piping distance of 11-13/16 inch (300mm) or less between the drain socket root to the drain riser.

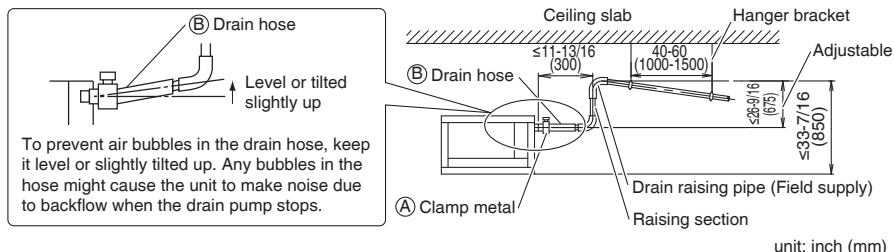

- To ensure no excessive pressure is applied to the included (B) drain hose, do not bend or twist the hose when installing as it could cause leakage.
- If converging multiple drain pipes, install according to the procedure shown below.

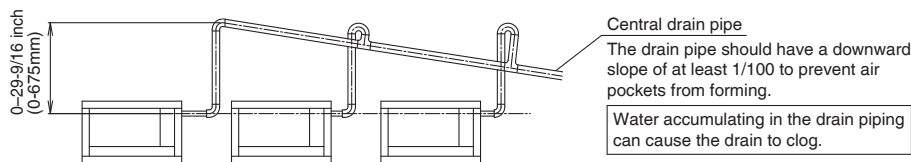

Select converging drain pipes with gauges is suitable for the operating capacity of the unit.

- Positioning the upward drain piping at an angle may cause float switch malfunction and lead to water leakage.
- While replacing with new indoor unit, use the attached new (B) drain hose and the (A) clamp metal. If an old drain hose or a clamp metal is used, it may cause water leakage.

2. After piping work is finished, check if drainage flows smoothly

When electric wiring work is finished

- Gradually pour 1/4 gal of water from the inspection port at the bottom of the drain socket on the left side of the drain socket into the drain pan giving caution to avoid splashing water on the electric components such as drain pump and confirm drainage by operating the indoor unit under cooling mode according to **Field settings**.

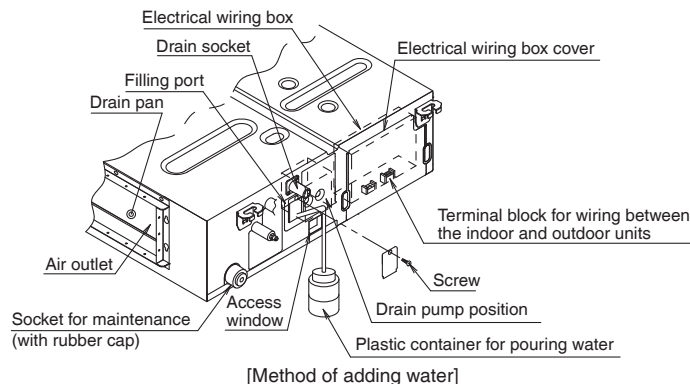

When electric wiring work is not finished

- The electric wiring works (including grounding) must be carried out by a qualified electrician.
- If a qualified person is not present, after the electric wiring work is finished, check the drainage according to the method specified in [When the electric wiring work is finished].
 1. Open the electrical wiring box cover and connect the ground wiring to the ground terminal.
 2. Make sure the electrical wiring box cover is closed before turning on the power supply.
 - Throughout the whole process, carry out the work giving caution to the wiring around the electrical wiring box so that the connectors may not come off.
 3. Gradually pour 1 litre of water from the air outlet on the left side of the drain socket into the drain pan giving caution to avoid splashing water on the electric components such as drain pump.
 4. When the power supply is turned on, the drain pump will operate. Drainage can be checked at the transparent part of the drain socket.

(The drain pump will automatically stop after 10 minutes.)

The drainage of water can be confirmed with water level change in the drain pan through the access window.

 - Do not connect the drain piping directly to the sewage that gives off ammonia odor. The ammonia in the sewage may go through the drain piping and corrode the heat exchanger of the indoor unit.
 - Do not apply external force to the float switch. (It may result in malfunction)
 - Do not touch the drain pump. Touching the drain pump may cause electric shock.
 5. Turn off the power supply after checking drainage, and remove the power supply wiring.
 6. Attach the electrical wiring box cover as before.

3. Sweating may occur and result in water leakage. Therefore, make sure to insulate the following 2 locations (drain piping that laid indoors and drain sockets).

- Use the provided (F) sealing pad (large), and perform the thermal insulation of the (A) clamp metal and (B) drain hose after checking the drainage of water.

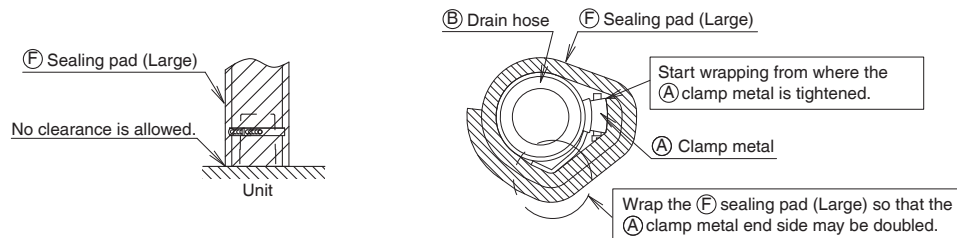

Indoor Unit Installation

9. Wiring

1. General instructions

- Make certain that all electric wiring work is carried out by qualified personnel according to the applicable legislation and this installation manual, using a separate dedicated circuit. Insufficient capacity of the power supply circuit or improper electrical construction may lead to electric shock or a fire.
- Make sure to install a ground fault circuit interrupter. Failure to do so may cause electric shock and a fire.
- Do not turn on the power supply (branch switch, branch overcurrent circuit breaker) until all the works are finished.
- Multiple number of indoor units are connected to one outdoor unit. Name each indoor unit as A-unit, B-unit and the like. When these indoor units are wired to the outdoor unit, always wire the indoor unit to the terminal indicated with the same symbol on the terminal block. If the wiring and the piping are connected to the different indoor units and operated, it will result in malfunction.
- Make sure to ground the air conditioner. Grounding resistance should be according to applicable legislation.
- Do not connect the ground wiring to gas or water pipings, lightning conductor or telephone ground wiring.
 - Gas pipingIgnition or explosion may occur if the gas leaks.
 - Water piping.....Hard vinyl tubes are not effective grounds.
 - Lightning conductor or telephone ground wiring.....Electric potential may rise abnormally if struck by a lightning bolt.
- For electric wiring work, refer to also the "WIRING DIAGRAM" attached to the electrical wiring box cover.
- Carry out wiring between the outdoor units, indoor units and the remote controllers according to the wiring diagram.
- Carry out installation and wiring of the remote controller according to the "installation manual" attached to the remote controller.
- Do not touch the Printed Circuit Board assembly. It may cause malfunction.

⚠ WARNING

- Do not use tapped wires, extension cords, or starburst connections, as they may cause overheating, electric shock, or fire.
- Do not use locally purchased electrical parts inside the product. (Do not branch the power for the drain pump, etc., from the terminal block.) Doing so may cause electric shock or fire.
- Do not connect the power wire to the indoor unit. Doing so may cause electric shock or fire.

⚠ CAUTION

- When clamping wiring, use the included clamping material to prevent outside pressure being exerted on the wiring connections and clamp firmly. When doing the wiring, make sure the wiring is neat and does not cause the electrical wiring box cover to stick up, then close the cover firmly.
- Outside the unit, separate the low voltage wiring (remote controller wiring) and high voltage wiring (wiring between units, ground, and other power wiring) at least 2 in. so that they do not pass through the same place together. Proximity may cause electrical interference, malfunctions, and breakage.

2. Wiring example

For the wiring of outdoor units, refer to the installation manual attached to the outdoor units.

Confirm the system type.

- **Multi system:** 2 through 6 (The number of connectable units will vary according to model) indoor units connect to 1 outdoor unit. The indoor unit is controlled by remote controller connected to each indoor unit.

NOTE

1. All transmission wiring except for the remote controller wires is polarized and must match the terminal symbol.
2. In case a shielding wire is to be used, connect a shielded portion with the ⚡ of a remote controller terminal block. (Also, connect the ground for the remote control to a grounded metal part.)

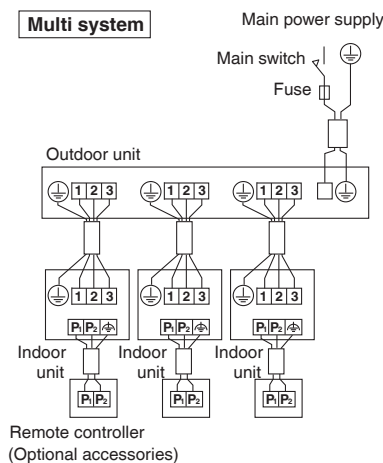

3. Specification for field wire

	Wire	Size	Length
Wiring between units	Recommend stranded and shielded. Local code supersedes recommendation.	AWG 14	-
Remote controller wiring	Sheathed (2 wire)	AWG 18 - 16	Max. 1640ft (500m)*
Wiring to ground terminal	Recommend stranded and shielded. Local code supersedes recommendation.	-	-

* This will be the total extended length in the system when doing group control.

4. Wiring connection method

⚠ CAUTION FOR WIRING

Recommend stranded cable for interunit wiring. Local code always supersedes recommendation.

- For stranded wires, make sure to use the round crimp-style terminal for connection to the power supply terminal block. Place the round crimp-style terminals on the wires up to the covered part and secure in place.

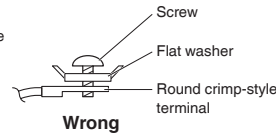
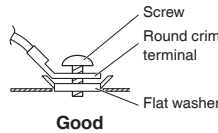
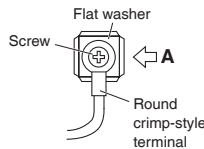
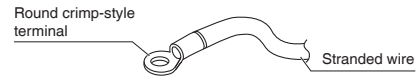

Arrow view A

- If solid core wire must be used, be sure to curl the end of the lead. Improper work may cause heat and fire.

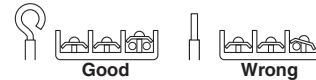

Tightening torque for the terminal blocks

- Use the correct screwdriver for tightening the terminal screws. If the blade of screwdriver is too small, the head of the screw might be damaged, and the screw will not be properly tightened.
- If the terminal screws are tightened too hard, screws might be damaged.
- Refer to the table below for the tightening torque of the terminal screws.

unit: lbf • ft (N • m)

	Tightening torque
Terminal block for remote controller (6P)	0.58 - 0.72 (0.79 - 0.98)
Terminal block for power supply (4P)	0.87 - 1.06 (1.18 - 1.44)

⚠ WARNING

- When wiring, form the wirings orderly so that the electrical wiring box cover can be securely fastened. If the electrical wiring box cover is not in place, the wirings may come out or be sandwiched by the box and the lid and cause electric shock or a fire.

- 1) Remove the electrical wiring box cover.

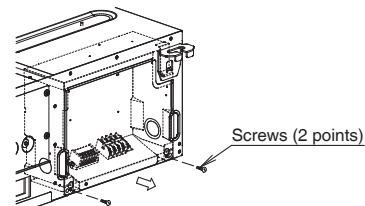

Indoor Unit Installation

2) Attach the conduit to the (M) conduit mounting plate.

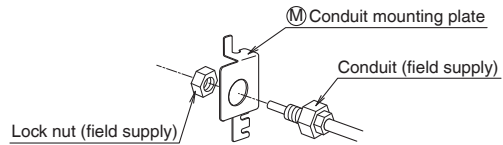

- Attach the (K) wire sealing pad (small) to the conduit, the wiring between the indoor and outdoor units, and the ground wiring.

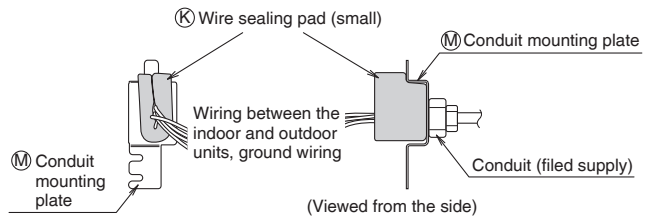

- Loosen the screws (2 points) in part A.

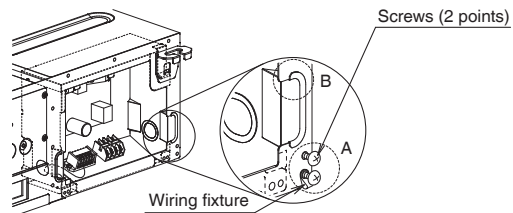

- Insert the hook part of the (M) conduit mounting plate into part B and secure the (M) conduit mounting plate with the screws loosened (2 points).

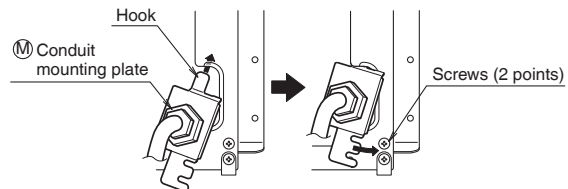

NOTE

Remove the wiring fixture if you have difficulty performing this step.

3) Connect the wiring into the electrical wiring box through the wiring intake beside the electrical wiring box.

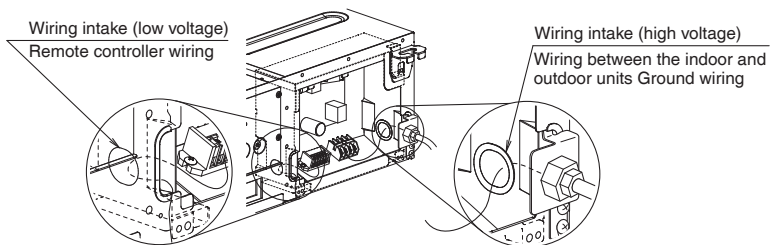

4) Follow the instructions below and perform wiring in the electrical wiring box.

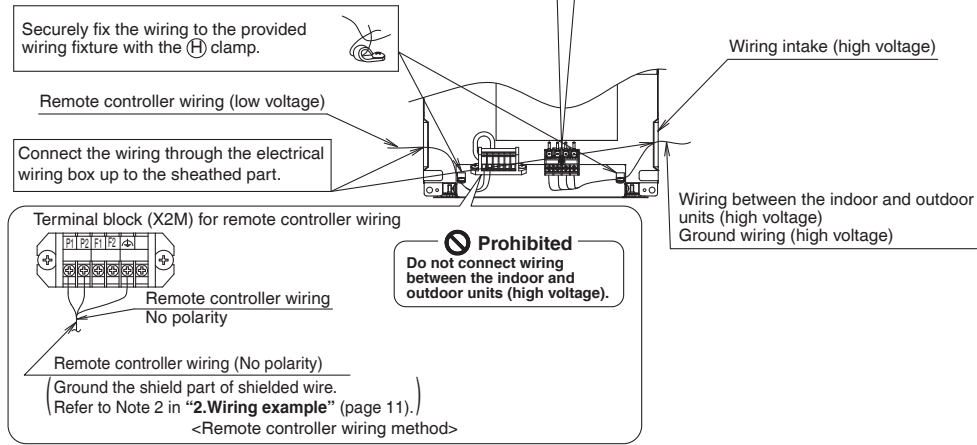
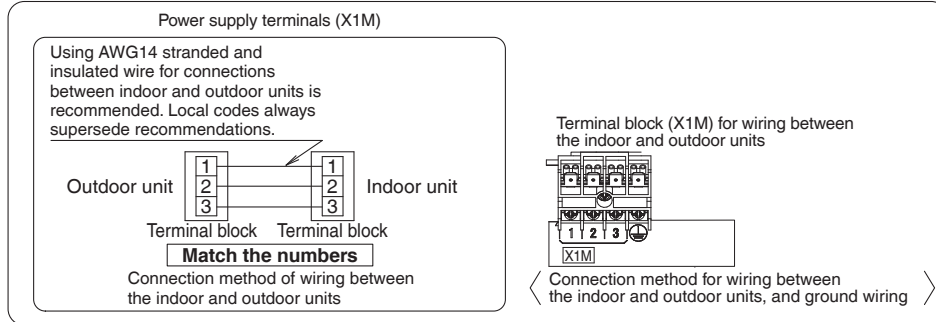

NOTE

Secure the wiring between the wiring intake and conduit with the (H) clamp so that the wiring will not become loose.

5) Mount the electrical wiring box cover and wrap the (K) wire sealing pad (small) so that the wiring through hole will be covered by the sealing pad.

- Seal the clearance around the wirings with putty or insulating material (field supply). (If insects and small animals get into the indoor unit, short-circuiting may occur inside the electrical wiring box.)

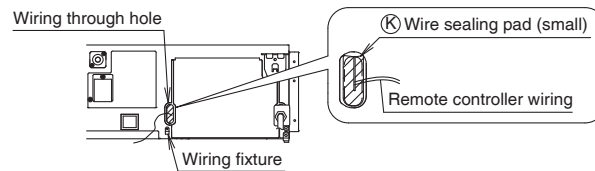

6) Securely fix each wiring with the provided (H) clamp material.

- See the installation manual supplied with the outdoor unit.

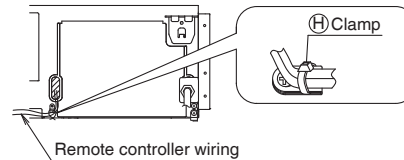

Indoor Unit Installation

10. Duct work

Pay the utmost attention to the following items and conduct the duct work.

- Check that the duct is not in excess of the setting range of external static pressure for the unit. (Refer to the technical datasheet for the setting range.)
- Attach a canvas duct each to the air outlet and air inlet so that the vibration of the equipment will not be transmitted to the duct or ceiling.
Use a sound-absorbing material (insulation material) for the lining of the duct and apply vibration insulation rubber to the suspension bolts.
- At the time of duct welding, perform the curing of the duct so that the sputter will not come in contact with the drain pan for the filter.
- If the metal duct passes through a metal lath, wire lath, or plate of a wooden structure, separate the duct and wall electrically.
- Be sure to heat insulate the duct for the prevention of dew condensation. (Material: Glass wool or styrene foam; Thickness: 1 inch (25mm))
- Be sure to attach the field supply air filter to the air inlet of the unit or field supply inlet in the air passage on the air suction side. (Be sure to select an air filter with a duct collection efficiency of 50 weight percent.)
- Explain the operation and washing methods of the locally procured components (i.e., the air filter, air inlet grille, and air outlet grille) to the user.
- Locate the air outlet grille on the indoor side for the prevention of drafts in a position where indirect contact with people.
- The air conditioner incorporates a function to adjust the fan to rated speed automatically. (Field settings)
Therefore, do not use booster fans midway in the duct.

Connection method of ducts on air inlet and outlet sides.

- Connect the field supply duct in alignment with the inner side of the flange.
- Connect the flange and unit with the © duct flange connection screw.
- Wrap aluminium tape around the flange and duct joint in order to prevent air leakage.
- Do not create air outlets in multiple rooms for 1 unit.

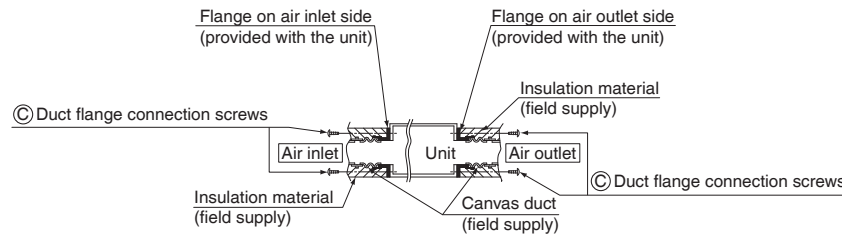

⚠ CAUTION

Connect the flange and unit with the © duct flange connection screw regardless of whether the duct is connected to the air inlet side.

Refrigerant Piping Work

Refer also to the installation manual for the outdoor unit.

⚠ WARNING

- Do not apply mineral oil on flared part.
- Prevent mineral oil from getting into the system as this would reduce the service life of the units.
- Never use piping which has been used for previous installations. Only use parts which are delivered with the unit.
- Never install a dryer to this R410A unit in order to guarantee its service life.
- The drying material may dissolve and damage the system.
- Incomplete flaring may result in refrigerant gas leakage.

Execute thermal insulation work completely on both sides of the gas and the liquid piping. Otherwise, a water leakage can result sometimes.

For gas piping, use insulation material of which heat resistant temperature is not less than 230°F (110°C).

Also, in cases where the temperature and humidity of the refrigerant piping sections might exceed 86°F (30°C) or RH80%, reinforce the refrigerant insulation. (13/16 inch (20mm) or thicker) Condensation may form on the surface of the insulating material.

Before refrigerant piping work, check which type of refrigerant is used. Proper operation is not possible if the types of refrigerant are not the same.

1. Flaring the pipe end

- 1) Cut the pipe end with a pipe cutter.
- 2) Remove burrs with the cut surface facing downward, so that the filings do not enter the pipe.



- 3) Put the flare nut on the pipe.
- 4) Flare the pipe.
- 5) Check that the flaring has been done correctly.

Flaring

Set exactly at the position shown below.

Flare tool for R32 or R410A	Conventional flare tool		
	Clutch-type	Clutch-type (Rigid-type)	Wing-nut type (Imperial-type)
A	0-0.020 inch (0-0.5mm)	0.039-0.059 inch (1.0-1.5mm)	0.059-0.079 inch (1.5-2.0mm)

Check

The flare's inner surface must be flaw-free.

The pipe end must be evenly flared in a perfect circle.

When flaring, do not over-tighten and crack.

Make sure that the flare nut is fitted.

2. Refrigerant piping

⚠ CAUTION

- Use the flare nut fixed to the main unit. (This is to prevent the flare nut from cracking as a result of deterioration over time.)
- To prevent gas leakage, apply refrigeration oil only to the inner surface of the flare. (Use refrigeration oil for R410A.)
- Use a torque wrench when tightening the flare nuts to prevent damage to the flare nuts and gas leakage.
- Do not have oil adhere to the screw fixing part of resin parts. If oil adheres, it may weaken the strength of screwed part.

- Align the centers of both flares and tighten the flare nuts 3 or 4 turns by hand, then tighten them fully with a spanner and a torque wrench.

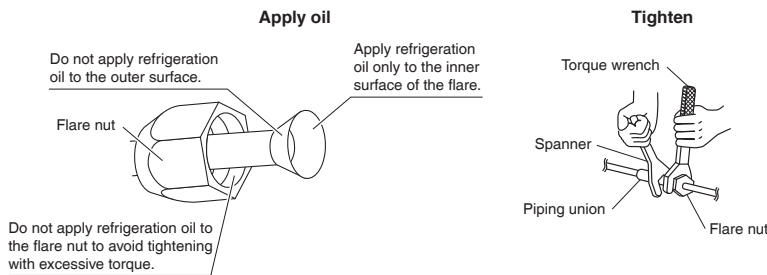

	Piping size	Flare nut tightening torque
Gas side	O.D. 3/8 inch (9.5mm)	24-1/8-29-1/2lbf • ft (32.7-39.9N • m)
	O.D. 1/2 inch (12.7mm)	36-1/2-44-1/2lbf • ft (49.5-60.3N • m)
	O.D. 5/8 inch (15.9mm)	45.6-55.6lbf • ft (61.8-75.4N • m)
Liquid side	O.D. 1/4 inch (6.4mm)	10-1/2-12-3/4lbf • ft (14.2-17.2N • m)

Refrigerant Piping Work

Cautions on piping handling

- Protect the open end of the pipe from dust and moisture.
- All pipe bends should be as gentle as possible. Use a pipe bender for bending.

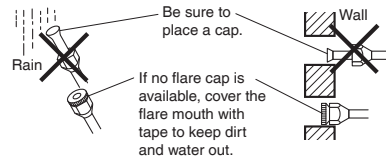

Selection of copper and heat insulation materials

When using commercial copper pipes and fittings, observe the following:

- Insulation material: Polyethylene foam
Heat transfer rate: 0.041 to 0.052W/mK (0.024 to 0.030Btu/ft^h°F (0.035 to 0.045kcal/mh°C))
Be sure to use insulation that is designed for use with HVAC Systems.
- ACR Copper pipe only.

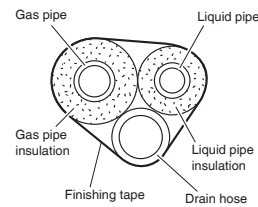

- Be sure to insulate both the gas and liquid piping and observe the insulation dimensions as below.

	Piping size	Minimum bend radius	Piping thickness	Thermal insulation size	Thermal insulation thickness
Gas side	O.D. 3/8 inch (9.5mm)	1-3/16 inch (30mm) or more	0.031 inch (0.8mm) (C1220T-O)	I.D. 15/32-19/32 inch (12-15mm)	13/32 inch (10mm) Min.
	O.D. 1/2 inch (12.7mm)	1-9/16 inch (40mm) or more		I.D. 9/16-5/8 inch (14-16mm)	
	O.D. 5/8 inch (15.9mm)	1-15/16 inch (50mm) or more	0.039 inch (1.0mm) (C1220T-O)	I.D. 5/8-13/16 inch (16-20mm)	
Liquid side	O.D. 1/4 inch (6.4mm)	1-3/16 inch (30mm) or more	0.031 inch (0.8mm) (C1220T-O)	I.D. 5/16-13/32 inch (8-10mm)	

- Use separate thermal insulation pipes for gas and liquid refrigerant pipes.
- Make absolutely sure to execute thermal insulation works on the pipe-connecting section, after checking for gas leakage, by thoroughly studying the following figures and using the included thermal insulating materials (D) fitting insulation and (E) fitting insulation. Fasten both ends with the (H) clamps.
- Make sure to bring the seam of (D) fitting insulation and (E) fitting insulation to the top.

Piping insulation procedure

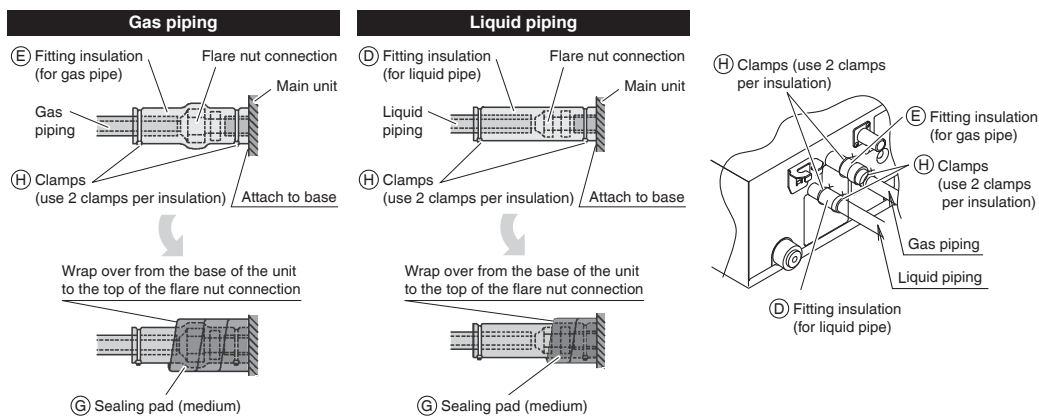

CAUTION

Be sure to insulate any field piping all the way to the piping connection inside the unit. Any exposed piping may cause condensation or burns if touched.

Field Settings

⚠ CAUTION

Before carrying out field setting, check the items mentioned in “2. Test items” (page 21).

- Check if all the installation and piping works for the air conditioner are completed.
- Check that the outside panel and piping cover of the indoor and outdoor units are closed.

After turning on the power supply, carry out field setting from the remote controller according to the installation state.

- The settings shown by in the following tables indicate those when shipped from the factory.
- Carry out setting at 3 places, “Mode No.,” “FIRST CODE No.” and “SECOND CODE No.”.
- The method of setting procedure and operation is shown in the installation manual attached to the remote controller.
- Ask the user to keep the manual attached to the remote controller together with the operation manual.
- Do not carry out settings other than those shown in the table.

NOTE

- Though setting of “Mode No.” is carried out as a group, if you intend to carry out individual setting by each indoor unit or confirmation after setting, carry out setting with the Mode No. shown in the parenthesis ().

1. Setting remote controller

When using wireless remote controllers

- When using the wireless remote controllers, wireless remote controller address setting is necessary. Refer to the installation manual attached to the wireless remote controller.

2. Settings for external static pressure

Make settings in either method (a) or method (b).

(a) Make settings with Air volume automatic adjustment function.

“Air volume automatic adjustment” function: The air volume is adjusted to the rated air volume automatically.

⚠ CAUTION

- Be sure to check that the external static pressure is within the specification range before making settings. The external static pressure will not be automatically adjusted and air volume insufficiency or water leakage may result if the external static pressure is outside the range. (Refer to the technical document for the setting range of external static pressure.)

- 1) Check that the electrical wiring and duct work have been completed.
(If the closing damper is set midway, be sure to check that the damper is opened. Furthermore, check that the air passage on the suction side is provided with an air filter (field supply)).
- 2) If air conditioner has more than one air outlet and air inlet, be sure to make adjustments so that the air volume ratio of each air outlet and the corresponding air inlet will conform to the designed air volume ratio.
In that case, set the operating mode to “Fan”. (In the case of changing the air volume, press the fan speed button on the remote controller and change the current selection to “High”, “Medium”, or “Low”.)
- 3) Make settings to adjust the air volume automatically.
After setting the operating mode to “Fan”, set the air conditioner to field setting mode with the operation of the air conditioner stopped. Select Mode No. [21] (11 in the case of batch settings), select FIRST CODE No. “7”, and set the SECOND CODE No. to “03”.
Return to the “Basic screen” (“Normal mode” if a wireless remote controller is used), and press the ON/OFF button. The operation lamp is lit, and the indoor unit will go into fan operation for air volume automatic adjustments (at which time, do not adjust the opening of the air outlet or inlet). The air volume adjustments will automatically terminate approximately 1 to 15 minutes after the indoor unit comes into operation, and the operation lamp will be OFF and the indoor unit will come to a stop.

Air volume adjustment

Setting content	Mode No.	FIRST CODE No.	SECOND CODE No.
OFF			01
Air volume adjustment completion	11 (21)	7	02
Air volume adjustment start			03

Field Settings

⚠ CAUTION

- If airflow pathway changes, such as duct and air outlet changes, are made after air volume adjustments, be sure to make “Air volume automatic adjustment” again.
- If airflow pathway changes, such as duct and air outlet changes, are made after “Trial Operation and Testing” (page 20) or air conditioner relocation, contact your dealer.

(b) Select external static pressure with the remote controller.

Check with Mode No. [21] per indoor unit that the SECOND CODE No. for the above “Air volume adjustment” is set to “01” (OFF). (The SECOND CODE No. is factory set to “01” (OFF).)

Change the SECOND CODE No. by referring to the table below according to the external static pressure of the duct to be connected.

External static pressure

For 07/09/12 class

Setting content	Mode No.	FIRST CODE NO.	SECOND CODE NO.
0.12 in. WG (30Pa)	13 (23)	6	03
0.16 in. WG (40Pa)			04
0.20 in. WG (50Pa)			05
0.24 in. WG (60Pa)			06
0.28 in. WG (70Pa)			07
0.32 in. WG (80Pa)			08
0.36 in. WG (90Pa)			09
0.40 in. WG (100Pa)			10
0.44 in. WG (110Pa)			11
0.48 in. WG (120Pa)			12
0.52 in. WG (130Pa)			13
0.56 in. WG (140Pa)			14
0.60 in. WG (150Pa)			15

For 15/18/24 class

Setting content	Mode No.	FIRST CODE NO.	SECOND CODE NO.
0.20 in. WG (50Pa)	13 (23)	6	05
0.24 in. WG (60Pa)			06
0.28 in. WG (70Pa)			07
0.32 in. WG (80Pa)			08
0.36 in. WG (90Pa)			09
0.40 in. WG (100Pa)			10
0.44 in. WG (110Pa)			11
0.48 in. WG (120Pa)			12
0.52 in. WG (130Pa)			13
0.56 in. WG (140Pa)			14
0.60 in. WG (150Pa)			15

3. Setting for options

- For settings for options, see the installation manual provided with the option.

4. Setting air filter sign

- Remote controllers are equipped with liquid crystal display air filter signs to display the time to clean air filters.
- Change the SECOND CODE NO. depending on the amount of dirt or dust in the room.

AIR FILTER CLEANING TIME INDICATOR lamp display interval

Setting content	Contamination	Mode No.	FIRST CODE NO.	SECOND CODE NO.
Approx. 2500 hrs	Contamination-light	10 (20)	0	01
Approx. 1250 hrs	Contamination-heavy			02

AIR FILTER CLEANING TIME INDICATOR lamp display

Setting content	Mode No.	FIRST CODE NO.	SECOND CODE NO.
Display ON	10 (20)	3	01
Display OFF*			02

* Use “Display OFF” setting when cleaning indication is not necessary such as the case of periodical cleaning being carried out.

5. When implementing group control

- When using as a pair unit, you may control up to 16 units with the remote controller.
- In this case, all the indoor units in the group will operate in accordance with the group control remote controller.
- Select a remote controller which matches as many of the functions (swing flap, etc.) in the group as possible.

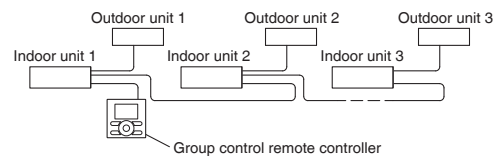

Wiring Method

- 1) Remove the electrical wiring box cover. (Refer to 1) Remove the electrical wiring box cover in “9. Wiring” on page 12.)
- 2) Cross-wire the terminal block for remote controller (P1, P2) inside the electrical wiring box. (There is no polarity.) (Refer to 3. Specification for field wire in “9. Wiring” on page 12)

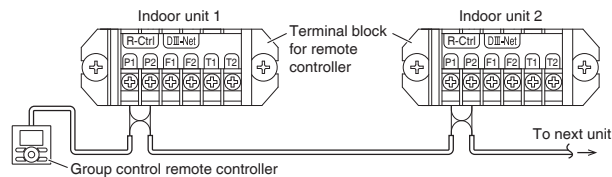

Trial Operation and Testing

After finishing the construction of refrigerant piping, drain piping, and electric wiring, conduct trial operation accordingly to protect the unit.

1. Trial operation and testing

⚠ CAUTION

After test operation is completed, check the items mentioned “Items to be checked at time of delivery” (page 22).
If the interior finish work is not completed when the test operation is finished, for protection of the air conditioner, ask the user not operate the air conditioner until the interior finish work is completed.
If the air conditioner is operated, the inside of the indoor units may be polluted by substances generated from the coating and adhesives used for the interior finish work and cause water splash and leakage.

Trial operation should be carried out in either COOL or HEAT operation.

1-1. Measure the supply voltage and make sure that it is within the specified range.

1-2. In COOL operation, select the lowest programmable temperature; in HEAT operation, select the highest programmable temperature.

1-3. Carry out the trial operation following the instructions in the operation manual to ensure that all functions and parts, such as the movement of the louvers, are working properly.

- To protect the air conditioner, restart operation is disabled for 3 minutes after the system has been turned off.

1-4. After trial operation is complete, set the temperature to a normal level (78°F to 82°F (26°C to 28°C) in COOL operation, 68°F to 75°F (20°C to 24°C) in HEAT operation).

- When operating the air conditioner in COOL operation in winter, or HEAT operation in summer, set it to the trial operation mode using the following method.

Refer to **For wired remote controller**.

Refer to **For wireless remote controller** (page 21).

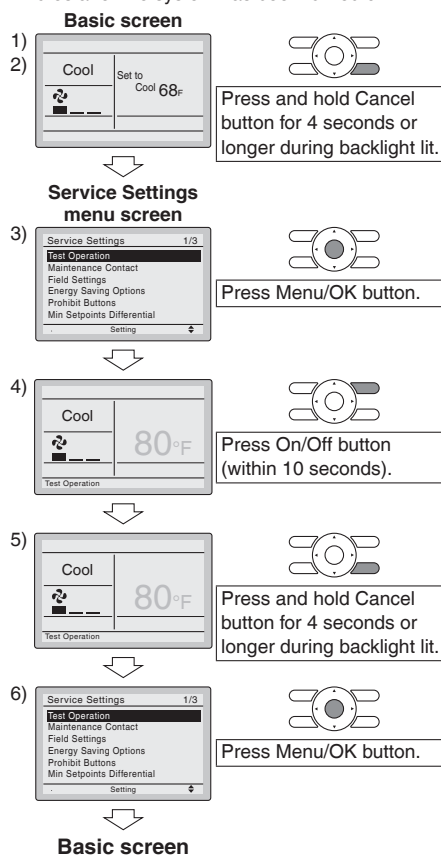

For wired remote controller

- Set to COOL or HEAT operation using the remote controller.
- Press and hold Cancel button for 4 seconds or longer. Service settings menu is displayed.
- Select **Test Operation** in the service settings menu, and press Menu/OK button. Basic screen returns and “Test Operation” is displayed at the bottom.
- Press On/Off button within 10 seconds, and the test operation starts.
Monitor the operation of the indoor unit for a minimum of 10 minutes. During test operation, the indoor unit will continue to cool/heat regardless of the temperature setpoint and room temperature.
 - In the case of above-mentioned procedures 3) and 4) in reverse order, test operation can start as well.
- Press and hold Cancel button for 4 seconds or longer in the basic screen. Service settings menu is displayed.
- Select **Test Operation** in the service settings menu, and press Menu/OK button. Basic screen returns and normal operation is conducted.
 - Test operation will stop automatically after 15-30 minutes. To stop the operation, press On/Off button.



Trial Operation and Testing

For wireless remote controller

- 1) Press  and select the COOL or HEAT operation.
- 2) Press  twice. "Test" is displayed.
- 3) Press  within 10 seconds, and the test operation starts.

Monitor the operation of the indoor unit for a minimum of 10 minutes.

During test operation, the indoor unit will continue to cool/heat regardless of the temperature setpoint and room temperature.

- In the case of above-mentioned procedures 1) and 2) in reverse order, test operation can start as well.
- Test operation will stop automatically after 15 - 30 minutes.

To stop the operation, press .

- Some of the functions cannot be used in the test operation mode.

Precautions

Refer to "3. How to diagnose for malfunction" (page 23) if the unit does not operate properly.

2. Test items



Test items	Symptom	Check
Indoor and outdoor units are installed securely.	Fall, vibration, noise	
No refrigerant gas leaks.	Incomplete cooling/heating function	
Refrigerant gas and liquid pipes and indoor drain hose extension are thermally insulated.	Water leakage	
Draining line is properly installed.	Water leakage	
The power supply voltage corresponds to that shown on the name plate.	No operation or burn damage	
System is properly grounded.	Electrical leakage	
Only specified wires are used for all wiring, and all wires are connected correctly.	No operation or burn damage	
Indoor or outdoor unit's air inlet or air outlet are unobstructed.	Incomplete cooling/heating function	
Refrigerant piping length and additional refrigerant charge are noted down.	The refrigerant charge in the system is not clear	
Pipes and wires are connected to the corresponding connection ports / terminal blocks for the connected unit.	No cooling/heating	
Stop valves are opened.	Incomplete cooling/heating function	
Indoor unit properly receives wireless remote control commands.	No operation	
The external static pressure is set correctly.	Incomplete cooling/heating function or water leakage	

Items to be checked at time of delivery

Also review the “Precautions” (page 3)

Test items	Check
The electrical wiring box cover and air filter are attached.	
I explained about operations while showing the operation manual to the user.	
Field setting has been carried out. (if necessary)	
It has been confirmed that the cool air discharges during the COOL operation and the warm air discharges during the HEAT operation. The indoor unit does not make unpleasant sounds of air discharge.	
I explained the set fan speed to the user (if the fan speed was set at thermostat OFF).	
I handed the operation manual over to the user.	
I have checked that there is no generation of abnormal noise (i.e., noise resulting from contamination or missing parts).	
The printed circuit board switch is not on the emergency (EMG.) side. The switch is factory set to the normal (NORM.) side.	
I have checked the operation of the optional accessory and made field settings as needed (if an optional accessory is in use).	
I have explained failure examples of “3.How to diagnose for malfunction” (page 23).	
I explained the power supply status (power supply ON/OFF) to the user.	

Points for explanation about operations

The items with  WARNING and  CAUTION marks in the operation manual are the items pertaining to possibilities for bodily injury and material damage in addition to the general usage of the product. Accordingly, it is necessary that you make a full explanation about the described contents and also ask your user to read the operation manual.

Note to the installer

Be sure to instruct user how to properly operate the unit (especially cleaning the filter, operating different functions, and adjusting the temperature) by having them carry out operations while looking at the manual.

 **To the operator carrying out test operation** _____
 After test operation is completed, before delivering the air conditioner to the user, confirm that the electrical wiring box cover is closed.
 In addition, explain the power supply status (power supply ON/OFF) to the user.

Trial Operation and Testing

3. How to diagnose for malfunction

- If the air conditioner does not operate normally after installing the air conditioner, a malfunction shown in the table below may happen.

Wired remote controller display	Description
No display	<ul style="list-style-type: none"> • Power outage, power voltage error or open-phase • Incorrect wiring (between indoor and outdoor units) • Indoor PC-board assembly failure • Remote controller wiring not connected • Remote controller failure • Open fuse or tripped circuit breaker (outdoor unit)
"Checking the connection. Please stand by:"*	<ul style="list-style-type: none"> • Indoor PC-board assembly failure • Wrong wiring (between indoor and outdoor units)

* "Checking the connection. Please stand by" will be displayed for up to 90 seconds following the application of power to the indoor unit. This is normal and does not indicate a malfunction.

- Diagnose with the display on the liquid crystal display remote controller.

With the wired remote controller

When the operation stops due to a malfunction, operation lamp blinks, and the malfunction code is indicated on the liquid crystal display. In such a case, diagnose the fault contents by referring to **Error History** in the service settings menu. In the case of group control, the unit No. is displayed so that the indoor unit with the trouble can be identified.

With the wireless remote controller

(Refer also to the operation manual attached to the wireless remote controller)

When the operation stops due to a malfunction the display on the indoor unit blinks. In such a case, diagnose the fault contents with the error code which can be found by following procedures.

- 1) Press the INSPECTION/TEST OPERATION button, "👁" is displayed and "0" blinks.
- 2) Press the TEMPERATURE SETTING button and find the unit No. which stopped due to trouble.

Number of beeps	3 short beeps.....	Perform all the following operations
	1 short beep	Perform (3) and (6)
	1 long beep.....	No trouble
- 3) Press the OPERATION MODE SELECTOR button and upper figure of the error code blinks.
- 4) Continue pressing the TEMPERATURE SETTING button until it makes 2 short beeps and find the upper code.
- 5) Press the OPERATION MODE SELECTOR button and lower figure of the error code blinks.
- 6) Continue pressing the TEMPERATURE SETTING button until it makes a long beep and find the lower code.
 - A long beep indicate the error code.

4. Malfunction code

- For places where the malfunction code is written in white, the "👁" indication is not displayed. Though the system continues operating, be sure to inspect the system and make repairs as necessary.
- Depending on the type of indoor or outdoor unit, the malfunction code may or may not be displayed.

Malfunction code	Descriptions and measures	Remarks
A1	Indoor Printed Circuit Board failure	
A3	Drain level abnormal	
A5	High pressure control or freeze-up protector	
A6	Indoor fan motor overload, over current, lock	
	Indoor Printed Circuit Board connection failure	
A8	Indoor unit power supply voltage abnormal	
AJ	Capacity setting failure	Capacity setting adapter or capacity data error, or disconnection of the capacity setting adapter, failure to connect the adapter, or the capacity is not set to the data-retention IC.

Malfunction code	Descriptions and measures	Remarks
C1	Transmission error between indoor Printed Circuit Board (Master) and indoor Printed Circuit Board (Slave)	
C4	Indoor heat exchanger liquid pipe temperature sensor malfunction	Abnormal stop is applied depending on the model or condition.
C5	Indoor heat exchanger condenser / evaporator temperature sensor malfunction	Abnormal stop is applied depending on the model or condition.
C9	Suction air thermistor malfunction	Abnormal stop is applied depending on the model or condition.
CJ	Remote controller air thermistor malfunction	Remote controller thermo does not function, but body thermo operation is enabled.
E0	Action of safety device (Outdoor unit)	
E1	Outdoor Printed Circuit Board failure (Outdoor unit)	
E3	High pressure switch (HPS) activated	Depending on the type of outdoor unit connected, the malfunction code may not be displayed.
E5	OL (compressor overload) started, high pressure switch (HPS) activated	Depending on the type of outdoor unit connected, the malfunction contents may be different.
E6	Compressor motor lock by over current (Outdoor unit)	
E7	Outdoor fan motor lock malfunction (Outdoor unit) Outdoor fan instant overcurrent malfunction (Outdoor unit)	
E8	Input overcurrent (Outdoor unit)	
EA	Cooling/heating switch malfunction (Outdoor unit)	
F3	Discharge piping temperature malfunction (Outdoor unit)	
F6	High pressure control (in cooling) (Outdoor unit)	
F8	Operation halt due to compressor internal temperature abnormality	
H0	Sensor fault for inverter (Outdoor unit)	
H6	Operation halt due to faulty position detection sensor	
H8	CT abnormality (Outdoor unit)	
H9	Outdoor air thermistor system malfunction (Outdoor unit)	Abnormal stop is applied depending on the model or condition.
J3	Discharge piping thermistor system malfunction (Outdoor unit)	Abnormal stop is applied depending on the model or condition.
J6	Outdoor heat exchanger distributor liquid piping thermistor malfunction (Outdoor unit)	Abnormal stop is applied depending on the model or condition.
L3	Reactor thermistor malfunction (Outdoor unit)	
L4	Overheated heat-radiating fin (Outdoor unit)	Inverter cooling failure.
L5	Instantaneous overcurrent (Outdoor unit)	The compressor engines and turbines may be experiencing a ground fault or short circuit.
P4	Heat-radiating fin thermistor malfunction (Outdoor unit)	Abnormal stop is applied depending on the model or condition.
U0	Suction piping temperature abnormal (Outdoor unit)	The refrigerant may be insufficient. Abnormal stop is applied depending on the model or condition.
U2	Power voltage malfunction (Outdoor unit)	The inverter open-phase or main circuit condenser may be malfunctioning. Abnormal stop is applied depending on the model or condition.
U4 UF	Transmission error (between indoor and outdoor units)	Wiring error between indoor and outdoor unit. Or Indoor and outdoor Printed Circuit Board failure.
U5	Transmission error (between indoor and remote controller units)	Transmission between indoor unit and remote controller is not performed properly.
U7	Transmission error of the inverter module	
UA	Field setting error	System setting error of the simultaneous on/off multi-split type.
UE	Transmission error (between indoor unit and centralized remote controller)	
UC	Remote controller address setting error	

12.3 FFQ

Contents

Safety Considerations	1	Refrigerant Piping Work	14
Before Installation	3	1. Flaring the pipe end.....	14
Accessories	3	2. Refrigerant piping	14
Choosing an Installation Site	4	Installation of the Decoration Panel	15
Indoor Unit Installation	6	Field Settings	16
1. Relation of ceiling opening to unit and suspension bolt position	6	1. Setting air outlet direction	16
2. Make the ceiling opening needed for installation where applicable (For existing ceilings).....	7	2. Setting for options.....	16
3. Installing the suspension bolts	7	3. Setting remote controller	16
4. Installing the indoor unit	7	4. Setting air filter sign	16
5. Drain piping work.....	8	5. When implementing group control.....	16
6. Wiring	11	6. 2 remote controllers (controlling 1 indoor unit by 2 remote controllers).....	17
		Trial Operation and Testing	17
		1. Trial operation and testing	17
		2. Test items	19
		3. How to diagnose for malfunction	20

The pictures in this document are for illustrative purposes only.

Safety Considerations

Refer also to the General Safety Considerations in the separate booklet.







Read the precautions in this manual carefully before operating the unit.

Read these **Safety Considerations for Installation** carefully before installing an air conditioner or heat pump. After completing the installation, make sure that the unit operates properly during the startup operation.

Instruct the user on how to operate and maintain the unit. Inform users that they should store this installation manual with the operation manual for future reference.

Always use a licensed installer or contractor to install this product. Improper installation can result in water or refrigerant leakage, electric shock, fire, or explosion.

Meanings of **DANGER**, **WARNING**, **CAUTION**, and **NOTE** Symbols:

-  **DANGER** Indicates an imminently hazardous situation which, if not avoided, will result in death or serious injury.
-  **WARNING** Indicates a potentially hazardous situation which, if not avoided, could result in death or serious injury.
-  **CAUTION** Indicates a potentially hazardous situation which, if not avoided, may result in minor or moderate injury. It may also be used to alert against unsafe practices.
-  **NOTE** Indicates situations that may result in equipment or property damage accidents only.

 **DANGER** _____

- Refrigerant gas is heavier than air and replaces oxygen. A massive leak can lead to oxygen depletion, especially in basements, and an asphyxiation hazard could occur leading to serious injury or death.
- Do not ground units to water pipes, gas pipes, telephone wires, or lightning rods as incomplete grounding can cause a severe shock hazard resulting in severe injury or death. Additionally, grounding to gas pipes could cause a gas leak and potential explosion causing severe injury or death.

- If refrigerant gas leaks during installation, ventilate the area immediately. Refrigerant gas may produce toxic gas if it comes into contact with fire. Exposure to this gas could cause severe injury or death.
- After completing the installation work, check that the refrigerant gas does not leak throughout the system.
- Do not install unit in an area where flammable materials are present due to risk of explosions that can cause serious injury or death.
- Safely dispose all packing and transportation materials in accordance with federal/state/local laws or ordinances. Packing materials such as nails and other metal or wood parts, including plastic packing materials used for transportation may cause injuries or death by suffocation.

 **WARNING** _____

- Only qualified personnel licensed or certified in their jurisdiction must carry out the installation work. Installation must be done in accordance with this installation manual. Improper installation may result in water leakage, electric shock, or fire.
- When installing the unit in a small room, take measures to keep the refrigerant concentration from exceeding allowable safety limits. Excessive refrigerant leaks, in the event of an accident in a closed ambient space, can lead to oxygen deficiency.
- Use only specified accessories and parts for installation work. Failure to use specified parts may result in water leakage, electric shock, fire, or the unit falling.
- Install the air conditioner or heat pump on a foundation strong enough that it can withstand the weight of the unit. A foundation of insufficient strength may result in the unit falling and causing injuries.
- Take into account strong winds, typhoons, or earthquakes when installing. Improper installation may result in the unit falling and causing accidents.
- Make sure that a separate power supply circuit is provided for this unit and that all electrical work is carried out by qualified personnel licensed or certified in their jurisdiction according to local, state, and national regulations. An insufficient power supply capacity or improper electrical construction may lead to electric shock or fire.
- Make sure that all wiring is secured, that specified wires are used, and that no external forces act on the terminal connections or wires. Improper connections or installation may result in fire.

- When wiring, position the wires so that the electrical wiring box cover can be securely fastened. Improper positioning of the electrical wiring box cover may result in electric shock, fire, or the terminals overheating.
- Before touching electrical parts, turn off the unit.
- The circuit must be protected with safety devices in accordance with local and national codes, i.e. a circuit breaker.
- Securely fasten the outdoor unit terminal cover (panel). If the terminal cover/panel is not installed properly, dust or water may enter the outdoor unit causing fire or electric shock.
- When installing or relocating the system, keep the refrigerant circuit free from substances other than the specified refrigerant (R410A) such as air. Any presence of air or other foreign substance in the refrigerant circuit can cause an abnormal pressure rise or rupture, resulting in equipment damage and even injury.
- Do not change the setting of the protection devices. If the pressure switch, thermal switch, or other protection device is shorted and operated forcibly, or parts other than those specified by Daikin are used, fire or explosion may occur.
- Do not use means to accelerate the defrosting process (if possible) or to clean, other than those recommended by the manufacturer.
- The appliance must be stored in a room without continuously operating ignition sources (for example: open flames, an operating gas appliance or an operating electric heater).
- Do not pierce or burn.
- Be aware that refrigerants may not contain an odor.
- Comply with national gas regulations.

⚠ CAUTION

- Do not touch the switch with wet fingers. Touching a switch with wet fingers can cause electric shock.
- Do not allow children to play on or around the unit to prevent injury.
- Wear adequate personal protective equipment (protective gloves, safety glasses,...) when installing, maintaining or servicing the system.
- The heat exchanger fins are sharp enough to cut. To avoid injury, wear gloves or cover the fins while working around them.
- Do not touch the refrigerant pipes during and immediately after operation as the refrigerant pipes may be hot or cold, depending on the condition of the refrigerant flowing through the refrigerant piping, compressor, and other refrigerant cycle parts. Your hands may suffer burns or frostbite if you touch the refrigerant pipes. To avoid injury, give the pipes time to return to normal temperature or, if you must touch them, be sure to wear proper gloves.
- Install drain piping to ensure proper drainage. Improper drain piping may result in water leakage and property damage.
- Insulate piping to prevent condensation.
- Be careful when transporting the product.
- Do not turn off the power immediately after stopping operation. Always wait for at least 5 minutes before turning off the power. Otherwise, water leakage may occur.
- Do not use a charging cylinder. Using a charging cylinder may cause the refrigerant to deteriorate.
- Refrigerant R410A in the system must be kept clean, dry, and tight.

- (a) Clean and Dry -- Foreign materials (including mineral oils such as SUNISO oil or moisture) should be prevented from getting into the system.

- (b) Tight -- R410A does not contain any chlorine, does not destroy the ozone layer, and does not reduce the earth's protection against harmful ultraviolet radiation. R410A can contribute to the greenhouse effect if it is released. Therefore take proper measures to check for the tightness of the refrigerant piping installation. Read the chapter *Refrigerant Piping Work* and follow the procedures.
- Since R410A is a blend, the required additional refrigerant must be charged in its liquid state. If the refrigerant is charged in a state of gas, its composition can change and the system will not work properly.
- The indoor unit is for R410A. See the catalog for outdoor models that can be connected. Normal operation is not possible when connected to non-compatible outdoor units.
- Remote controller (wireless kit) transmitting distance can be shorter than expected in rooms with electronic fluorescent lamps (inverter or rapid start types). Install the indoor unit far away from fluorescent lamps as much as possible.
- Indoor units are for indoor installation only. Outdoor units can be installed either outdoors or indoors.
- Do not install the air conditioner or heat pump in the following locations:
 - (a) Where a mineral oil mist or oil spray or vapor is produced, for example, in a kitchen. Plastic parts may deteriorate and fall off or result in water leakage.
 - (b) Where corrosive gas, such as sulfurous acid gas, is produced. Corroding copper pipes or soldered parts may result in refrigerant leakage.
 - (c) Near machinery emitting electromagnetic waves. Electromagnetic waves may disturb the operation of the control system and cause the unit to malfunction.
 - (d) Where flammable gas may leak, where there is carbon fiber, or ignitable dust suspension in the air, or where volatile flammables such as thinner or gasoline are handled. Operating the unit in such conditions can cause a fire.
- Take adequate measures to prevent the outdoor unit from being used as a shelter by small animals. Small animals making contact with electrical parts can cause malfunctions, smoke, or fire. Instruct the user to keep the area around the unit clean.
- Servicing shall be performed only as recommended by the manufacturer and licensed or certified in their jurisdiction.

⚠ NOTE

- The indoor unit should be positioned where the unit and inter-unit wires (outdoor to indoor) are at least 3.3ft (1m) away from any televisions or radios. (The unit may cause interference with the picture or sound.) Depending on the radio waves, a distance of 3.3ft (1m) may not be sufficient to eliminate the noise.
- Dismantling the unit, treatment of the refrigerant, oil and additional parts must be done in accordance with the relevant local, state, and national regulations.
- Only use tools for R410A, such as a gauge manifold, charge hose, gas leak detector, reverse flow check valve, refrigerant charge base, vacuum gauge, or refrigerant recovery equipment.
- If the conventional refrigerant and refrigerator oil are mixed in R410A, the refrigerant may deteriorate.
- This air conditioner or heat pump is an appliance that should not be accessible to the general public.
- As maximum allowable pressure is 604psi (4.17MPa), the wall thickness of field-installed pipes should be selected in accordance with the relevant local, state, and national regulations.

FTN005-U













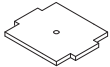

Before Installation

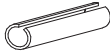
- Leave the unit inside its packaging until you reach the installation site. Where unpacking is unavoidable, use a sling of soft material or protective plates together with a rope when lifting, this to avoid damage or scratches to the unit.
When unpacking the unit or when moving the unit after unpacking, be sure to lift the unit by holding on to the hanger bracket without exerting any pressure on other parts, especially on refrigerant piping, drain piping and other resin parts.
- Refer to the installation manual of the outdoor unit for items not described in this manual.
- Caution concerning refrigerant series R410A:
The connectable outdoor units must be designed exclusively for R410A.

Precautions

- Do not install or operate the unit in places mentioned below.
 - Places with mineral oil, or filled with oil vapor or spray like in kitchens. (Plastic parts may deteriorate.)
 - Where corrosive gas like sulphurous gas exists. (Copper tubing and brazed spots may corrode.)
 - Where volatile flammable gas like thinner or gasoline is used.
 - Where machines generating electromagnetic waves exist. (Control system may malfunction.)
 - Where the air contains high levels of salt such as near the ocean and where voltage fluctuates a lot (e.g. in factories). Also inside vehicles or vessels.
- When selecting the installation site, use the supplied (E) template for installation.
- Do not install accessories on the casing directly. Drilling holes in the casing may damage electrical wires and consequently cause fire.
- Take off static electricity from the body when carrying out wiring and the electrical wiring box cover is removed.
The electric parts may be damaged.

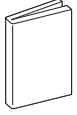
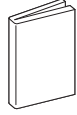
Accessories

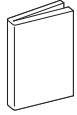
(A) Drain hose 	1	(B) Clamp metal 	1	(C) Washer for hanger bracket 	8	(D) Clamp 	7
(E) Template (cut out from upper part of packing) 	1	(F) Screws (M5) (for template) 	4	(G) Fitting insulation (for gas pipe) 	1	(H) Fitting insulation (for liquid pipe) 	1
(J) Sealing pad (large) 	1	(K) Sealing pad (medium A) 	1	(L) Sealing pad (medium B) 	1	(M) Sealing pad (small) 	1
(N) Washer for conduit 	1	(P) Operation manual 	1	(Q) Installation manual 	1	(R) Warranty 	1
(S) General safety considerations 	1						

Optional Accessories

- The optional decoration panel and remote controller are required for this indoor unit.

Table 1

Optional decoration panel		
Type A	BYFQ60B3W1	Color: White
Type B	BYFQ60C2W1W	Color: White
Type B	BYFQ60C2W1S	Color: Silver

- There are 2 types of remote controllers: wired and wireless. Select a remote controller from Table 2 according to customer request and install in an appropriate place.

Table 2

Remote controller type	Model name
Wired type	BRC1E73
Wireless type	BRC082A41W / BRC082A42W / BRC082A42S

- If you wish to use a remote controller that is not listed in Table 2, select a suitable remote controller after consulting catalogs and technical materials.

Choosing an Installation Site

Hold the unit by the 4 hanger brackets when opening the box and moving it, and do not exert pressure on to any other part, piping (refrigerant, drain, etc.), or plastic parts.

If the temperature or humidity inside the ceiling might rise above 86°F (30°C) or RH 80%, respectively, add extra insulation to the unit.

Use polyethylene foam as insulation and make sure it is at least 3/8 inch (10mm) thick and fits inside the ceiling opening.

Select the air flow directions best suited to the room and point of installation.

For air discharge in 3 directions, it is necessary to make field settings by means of the remote controller and to close the air outlet (s).

Refer to the installation manual of the blocking pad kit (sold separately) and to “Field Settings” on page 16.

- Before choosing the installation site, obtain user approval. The indoor unit should be positioned in a place where:
 - both the air inlet and air outlet are unobstructed,
 - the unit is not exposed to direct sunlight,
 - the unit is away from the source of heat or steam,
 - there is no source of machine oil vapor (this may shorten the indoor unit service life),
 - cool/warm air is circulated throughout the room,
 - the unit is away from electronic ignition type fluorescent lamps (inverter or rapid start type) as they may affect the remote controller range,
 - no laundry equipment is nearby,
 - drainage can be performed without any problem,
 - the weight of the indoor unit can be adequately supported,
 - the wall and the ceiling's lower surface are not significantly tilted,
 - room can be left for installation and service work,
 - there is no risk of flammable gas leaking,
 - the required length of indoor-outdoor piping would not exceed the specified maximum length (see the installation manual that came with the outdoor unit for details).

Choosing an Installation Site

Installation Space Requirements

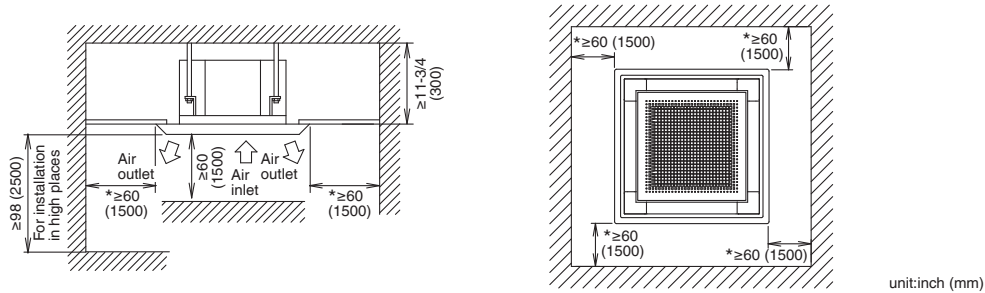

- Leave 8 inch (200mm) or more space where marked with the *, on sides where the air outlet is closed.

<Failure example>

If there is an obstacle in the airflow path or proper installation space is not provided, the indoor unit will cause air volume reduction and take in air blown out of the indoor unit, thus resulting in performance degradation or turning the thermostat OFF frequently.

Air flow direction

- The air direction shown is an example.
- Select the appropriate number of directions according to the shape of the room and the location of the unit. (Field settings have to be made using the remote controller and the outlet vents have to be shut off if 2 or 3 directions are selected. See the blocking pad kit (sold separately) installation manual for details.)

Air flow direction (Example)

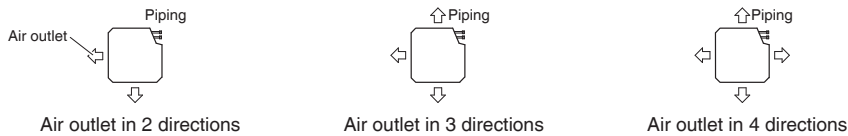

Use suspension bolts for installation. Check whether the ceiling is strong enough to support the weight of the unit or not. If there is a risk, reinforce the ceiling before installing the unit.

(Installation pitch is marked on the (E) template. Refer to it to check for points requiring reinforcing.)

Indoor Unit Installation

1. Relation of ceiling opening to unit and suspension bolt position

For decoration panel type A

Top view

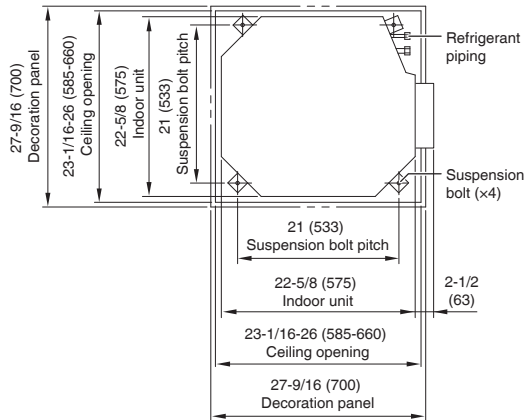

For decoration panel type B

Top view

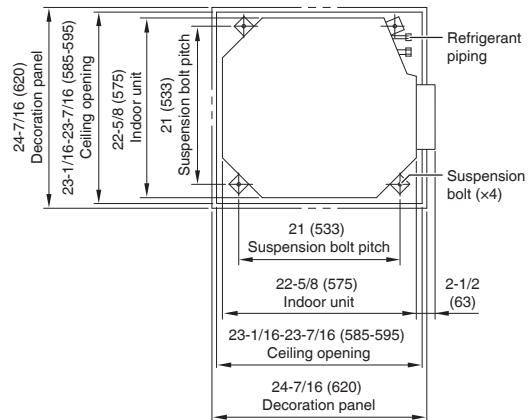

Side view

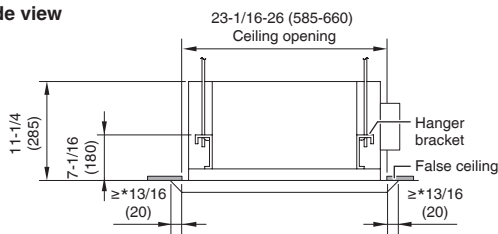

Side view

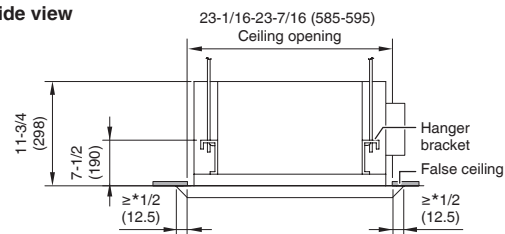

unit: inch (mm)

NOTE

- *If the panel does not extend over the ceiling by this amount, supplement with extra ceiling material or restore the ceiling.
- Install the inspection opening on the electrical wiring box side where maintenance and inspection of the electrical wiring box and drain pump are easy.

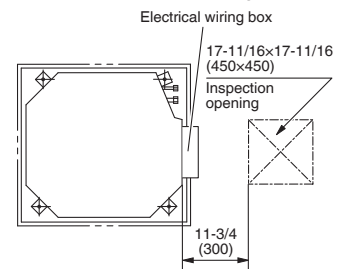

Indoor Unit Installation

2. Make the ceiling opening needed for installation where applicable (For existing ceilings)

- Refer to the (E) template for ceiling opening dimensions.
- Create the ceiling opening required for installation. From the side of the opening to the casing outlet, implement the refrigerant and drain piping and wiring for remote controller (unnecessary for wireless type) and wiring between units. Refer to each Drain piping work or Wiring section.
- After making an opening in the ceiling, it may be necessary to reinforce ceiling beams to keep the ceiling level and to prevent it from vibrating. Consult the builder for details.

3. Installing the suspension bolts

(Use either a M8-M10 size bolt or the equivalent)

Use a hole-in anchor for existing ceilings, and a sunken insert, sunken anchor or other field supplied parts for new ceilings to reinforce the ceiling to bear the weight of the unit. Adjust clearance (2-4 inch (50-100mm)) from the ceiling before proceeding further.

- All the above parts are field supplied.

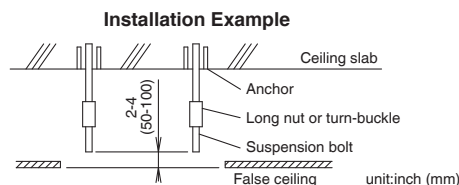

4. Installing the indoor unit

When installing optional accessories (except for the decoration panel), read also the installation manual of the optional accessories. Depending on the field conditions, it may be easier to install optional accessories before the indoor unit is installed. However, for existing ceilings, always install fresh air intake kit before installing the unit. As for the parts to be used for installation work, be sure to use the provided accessories and specified parts designated by Daikin.

For new ceilings

- 1) Install the indoor unit temporarily.
 - Attach the hanger bracket to the suspension bolt. Be sure to fix it securely by using a nut and (C) washer from the upper and lower sides of the hanger bracket.

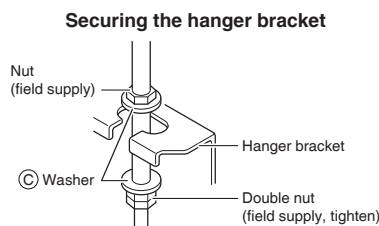

- 2) Refer to the (E) template for ceiling opening dimension. Consult the builder or carpenter for details.
 - The center of the ceiling opening is indicated on the (E) template. This indication also indicates the center of the unit.
 - The (E) template can be rotated by 90° to be able to indicate the correct dimensions on all 4 sides.
 - After cutting the template from the packaging, attach the (E) template to the unit with (F) screws (x4) as shown in figure.
 - Ceiling height is shown on the side of the (E) template. Adjust the height of the unit according to this indication.

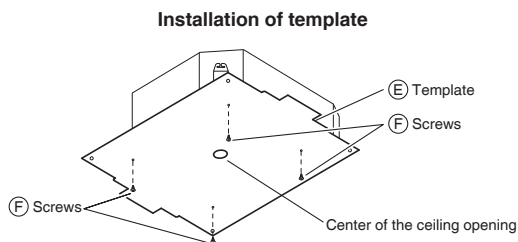

Ceiling work

- 3) Adjust the unit to the right position for installation. (Refer to 1. Relation of ceiling opening to unit and suspension bolt position.)

⚠ CAUTION

If the unit is tilted against condensate flow, the float switch may malfunction and cause water to drip.

- 4) Check the unit is horizontally level.
 - The indoor unit is equipped with a built-in drain pump and float switch. Verify that it is level by using a water level or a water-filled vinyl tube.
- 5) Remove the (E) template.

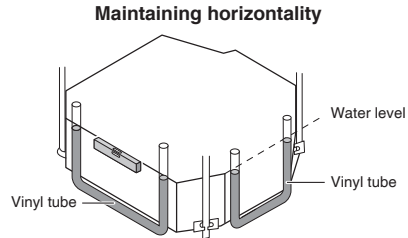

For existing ceilings

- 1) Install the indoor unit temporarily.
 - Attach the hanger bracket to the suspension bolt. Be sure to fix it securely by using a nut and (C) washer from the upper and lower sides of hanger bracket.

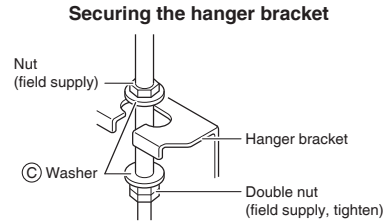

- 2) Adjust the height and position of the unit. (Refer to 1. Relation of ceiling opening to unit and suspension bolt position.)
- 3) Perform steps 4) in **For new ceilings**.

5. Drain piping work

⚠ CAUTION

- Water pooling in the drainage piping can cause the drain to clog.
- **Do not connect the drain piping directly to sewage pipes that smell of ammonia. The ammonia in the sewage might enter the indoor unit through the drain pipes and corrode the heat exchanger.**
- **Keep in mind that the drain pipe becomes blocked if water collects on it.**

1. Install of drain piping

- Install the drain piping as shown in the figure and take measures against condensation. Improperly rigged piping could lead to leaks and eventually wet furniture and belongings.
- Keep piping as short as possible and slope it downwards at a gradient of at least 1/100 so that air may not remain trapped inside the pipe.
- Keep pipe size equal to or greater than that of the connecting pipe (vinyl pipe of nominal diameter 13/16 inch (20mm) and outer diameter 1 inch (26mm)).
- Push the supplied drain hose as far as possible over the drain socket.
- If the drain hose cannot be sufficiently set on a slope, refer to **“Precautions for drain raising piping”**.
- To keep the drain hose from sagging, space hanger bracket every 40-60 inch (1000-1500mm).

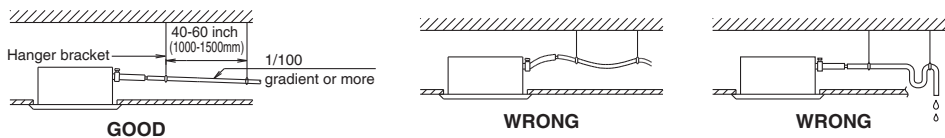

Indoor Unit Installation

- Tighten the (B) clamp metal as indicated in the illustration.
- After the testing of drain piping is finished, attach the drain (J) sealing pad (large) supplied with the unit over the uncovered part of the drain socket (= between drain hose and unit body).
- Wrap the supplied large sealing pad over the (B) clamp metal and (A) drain hose to insulate and fix it with clamps.
- Insulate the complete drain piping inside the building (field supply).
- If the drain hose cannot be sufficiently set on a slope, fit the hose with drain raising piping (field supply).

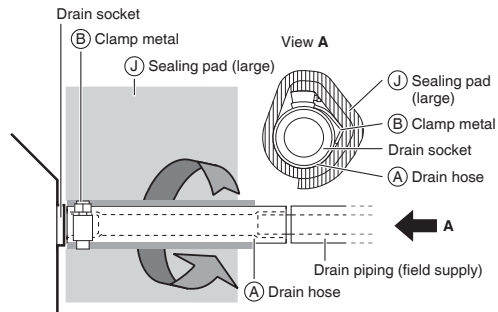

Precautions for drain raising piping

- Install the drain raising pipes at a height of less than H2.
- Install the drain raising pipes at a right angle to the indoor unit and no more than 11-3/4 inch (300mm) from the unit.

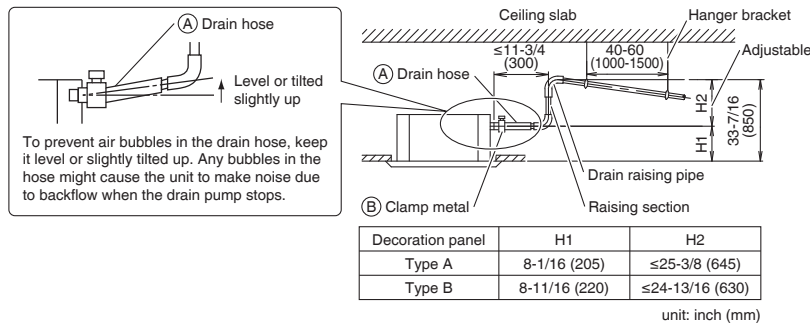

- To ensure no excessive pressure is applied to the included (A) drain hose, do not bend or twist the hose when installing as it could cause leakage.
- If converging multiple drain pipes, install according to the procedure shown below.

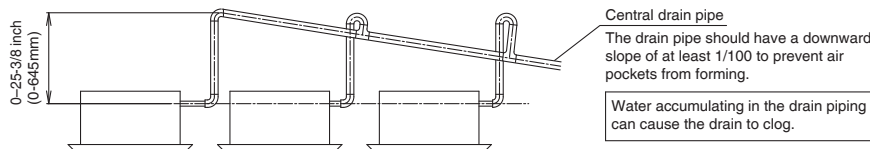

Select converging drain pipes with gauges is suitable for the operating capacity of the unit.

2. After piping work is finished, check if drainage flows smoothly

- Add approximately 1/4 gal of water slowly from the air outlet and check drainage flow.

Method of adding water

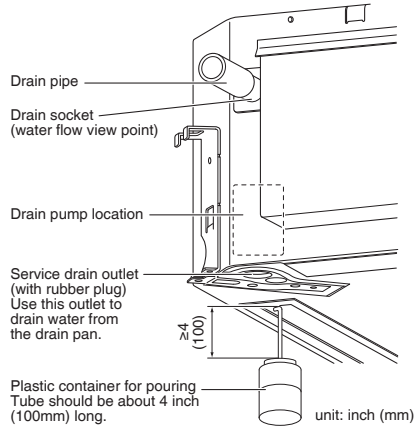

When electric wiring work is finished

- Check drainage flow during COOL operation, explained in “Trial operation and testing” on page 17.

When electric wiring work is not finished

⚠ CAUTION

Electrical wiring work should be done by a certified electrician.

- If someone who does not have the proper qualifications performs the work, perform the following actions after the trial operation is complete.
- 1) Remove the electrical wiring box cover (2 screws). Connect the single phase power supply (SINGLE PHASE 60 Hz 208/230V) to connections No.1 and No.2 on the terminal block for power supply. Do not connect to No.3 of the terminal block for power supply or the drain pump will not operate. When carrying out wiring work around the electrical wiring box, make sure none of the connectors come undone. Be sure to attach the electrical wiring box cover before turning on the power.
 - 2) After confirming drainage, turn off the power supply and remove the power supply wiring.
 - 3) Attach the electrical wiring box cover as before.

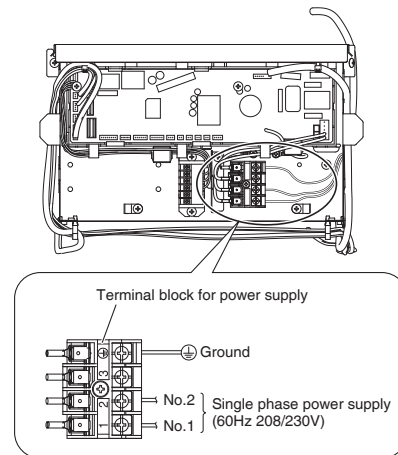
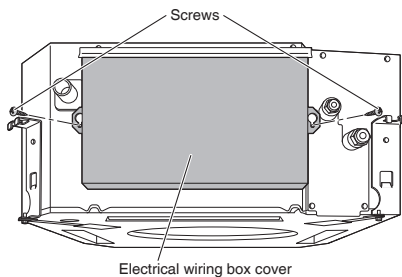

Indoor Unit Installation

6. Wiring

Refer also to the installation manual for the outdoor unit.

⚠ WARNING

- Do not use tapped wires, extension cords, or starburst connections, as they may cause overheating, electric shock, or fire.
- Do not use locally purchased electrical parts inside the product. (Do not branch the power for the drain pump, etc., from the terminal block.) Doing so may cause electric shock or fire.
- Do not connect the power wire to the indoor unit. Doing so may cause electric shock or fire.

⚠ CAUTION

Recommend stranded cable for interunit wiring. Local code always supersedes recommendation.

- For stranded wires, make sure to use the round crimp-style terminal for connection to the power supply terminal block. Place the round crimp-style terminals on the wires up to the covered part and secure in place.

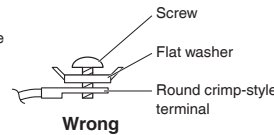
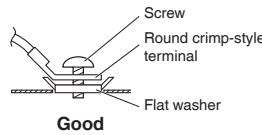
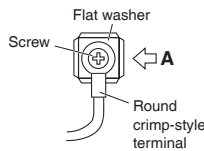
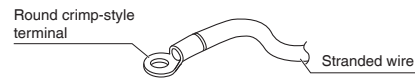

Arrow view A

- If solid core wire must be used, be sure to curl the end of the lead. Improper work may cause heat and fire.

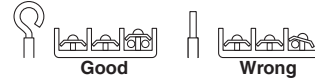

- When clamping wiring, use the included clamping material to prevent outside pressure being exerted on the wiring connections and clamp firmly. When doing the wiring, make sure the wiring is neat and does not cause the electrical wiring box cover to stick up, then close the cover firmly.
- Outside the unit, separate the low voltage wiring (remote controller wiring) and high voltage wiring (wiring between units, ground, and other power wiring) at least 2 in. so that they do not pass through the same place together. Proximity may cause electrical interference, malfunctions, and breakage.

Tightening torque for the terminal blocks

- Use the correct screwdriver for tightening the terminal screws. If the blade of screwdriver is too small, the head of the screw might be damaged, and the screw will not be properly tightened.
- If the terminal screws are tightened too hard, screws might be damaged.
- Refer to the table below for the tightening torque of the terminal screws.

unit: lbf • ft (N • m)

	Tightening torque
Terminal block for remote controller (6P)	0.58 - 0.72 (0.79 - 0.98)
Terminal block for power supply (4P)	0.87 - 1.06 (1.18 - 1.44)

- For electric wiring work, refer also to “**Wiring diagram label**” attached to the electrical wiring box cover.
- For remote controller wiring details, refer to the installation manual attached to the remote controller.
- A circuit breaker capable of shutting down power supply to the entire system must be installed.

- **Specifications for field wire**

The remote controller wiring should be procured locally.

Table 3

	Wire	Size	Length
Wiring between units	Recommend stranded and shielded. Local code supersedes recommendation.	AWG 14	–
Remote controller wiring	Sheathed (2 wire)	AWG 18 - 16	Max. 1640ft (500m)*
Wiring to ground terminal	Recommend stranded and shielded. Local code supersedes recommendation.	–	–

* This will be the total extended length in the system when doing group control.

CAUTION

- Arrange the wires and fix a cover firmly so that the cover does not float during wiring work.
- Do not clamp remote controller wiring together with wiring between units. Doing so may cause malfunction.
- Remote controller wiring and wiring between units should be located at least 2 inch (50mm) from other electric wires. Not following this guideline may result in malfunction due to electrical noise.

Indoor Unit Installation

Connection of wiring between units, ground wire and remote controller wiring

Wiring between units and ground wire

- 1) Remove the electrical wiring box cover (2 screws).

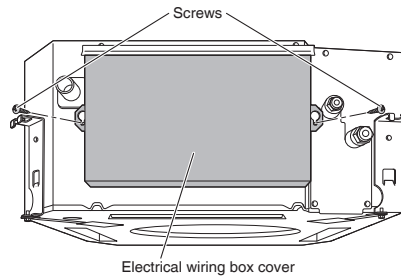

- 2) Insert the wires including the ground wire into the conduit, and secure the conduit to the hole in the electrical wiring box using a lock nut and the (N) washer for conduit, as shown in the illustration.

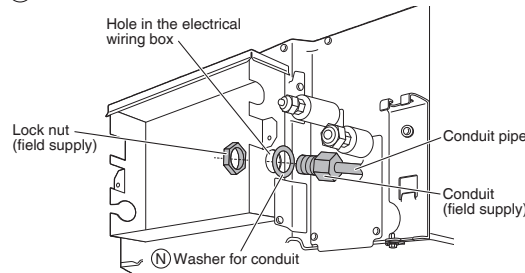

- 3) Connect the ground wire to the corresponding terminals.
- 4) Match wire colors with terminal numbers on the terminal block for power supply of indoor and outdoor unit and firmly secure the wires in the corresponding terminals with screws.
- 5) In doing this, pull the wires inside through the hole and fix the wires securely with the included (D) clamp.
- 6) Give enough slack to the wires between the (D) clamp and terminal block for power supply.
- 7) Pull the wires inside through the hole and connect them to the terminal block for remote controller (P1, P2) (no polarity). Securely fix the remote controller wiring with the included (D) clamp.
- 8) Give enough slack to the wires between the (D) clamp and the terminal block for remote controller.
- 9) Attach the electrical wiring box cover as before.
- 10) After all wiring connections are done, fill in any gaps in the casing wiring holes with putty or (M) sealing pad (small) thus to prevent small animals or dirt from entering the unit from outside and causing short circuits in the electrical wiring box.

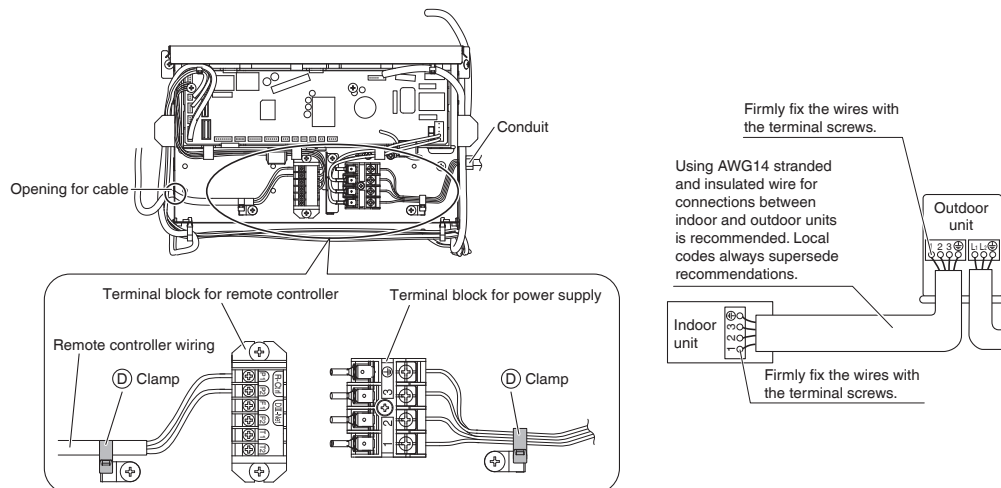

Refrigerant Piping Work

Refer also to the installation manual for the outdoor unit.

⚠ WARNING

- Do not apply mineral oil on flared part.
- Prevent mineral oil from getting into the system as this would reduce the service life of the units.
- Never use piping which has been used for previous installations. Only use parts which are delivered with the unit.
- Never install a dryer to this R410A unit in order to guarantee its service life.
- The drying material may dissolve and damage the system.
- Incomplete flaring may result in refrigerant gas leakage.

Execute thermal insulation work completely on both sides of the gas and the liquid piping. Otherwise, a water leakage can result sometimes.

Be sure to use insulation designed for use with HVAC systems.

Also, in cases where the temperature and humidity of the refrigerant piping sections might exceed 86°F (30°C) or RH80%, reinforce the refrigerant insulation. (13/16 inch (20mm) or thicker) Condensation may form on the surface of the insulating material.

Before refrigerant piping work, check which type of refrigerant is used. Proper operation is not possible if the types of refrigerant are not the same.

1. Flaring the pipe end

- 1) Cut the pipe end with a pipe cutter.
- 2) Remove burrs with the cut surface facing downward so that the filings do not enter the pipe.



- 3) Put the flare nut on the pipe.
- 4) Flare the pipe.
- 5) Check that the flaring has been done correctly.

Flaring

Set exactly at the position shown below.

	Flare tool for R410A		Conventional flare tool	
	Clutch-type	Clutch-type (Rigid-type)	Wing-nut type (Imperial-type)	
A	0-0.020 inch (0-0.5mm)	0.039-0.059 inch (1.0-1.5mm)	0.059-0.079 inch (1.5-2.0mm)	

Check

The flare's inner surface must be flaw-free.

When flaring, do not over-tighten and crack.

The pipe end must be evenly flared in a perfect circle.

Make sure that the flare nut is fitted.

2. Refrigerant piping

⚠ CAUTION

- Use the flare nut fixed to the main unit. (This is to prevent the flare nut from cracking as a result of deterioration over time.)
 - To prevent gas leakage, apply refrigeration oil only to the inner surface of the flare. (Use refrigeration oil for R410A.)
 - Use a torque wrench when tightening the flare nuts to prevent damage to the flare nuts and gas leakage.
-
- Align the centers of both flares and tighten the flare nuts 3 or 4 turns by hand, then tighten them fully with a spanner and a torque wrench.

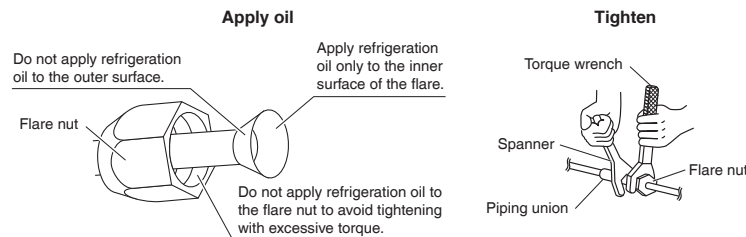

	Piping size	Flare nut tightening torque
Gas side	O.D. 3/8 inch (9.5mm)	24-1/8-29-1/2lbf • ft (32.7-39.9N • m)
	O.D. 1/2 inch (12.7mm)	36-1/2-44-1/2lbf • ft (49.5-60.3N • m)
Liquid side	O.D. 1/4 inch (6.4mm)	10-1/2-12-3/4lbf • ft (14.2-17.2N • m)

Cautions on piping handling

- Protect the open end of the pipe from dust and moisture.
- All pipe bends should be as gentle as possible. Use a pipe bender for bending.

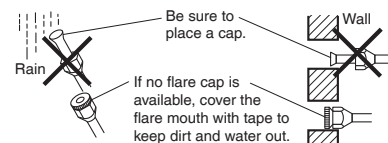

Refrigerant Piping Work

Selection of copper and heat insulation materials

When using commercial copper pipes and fittings, observe the following:

- Insulation material: Polyethylene foam
Heat transfer rate: 0.041 to 0.052W/mK (0.024 to 0.030Btu/ft²h°F (0.035 to 0.045kcal/mh°C))
Be sure to use insulation that is designed for use with HVAC Systems.
- ACR Copper pipe only.

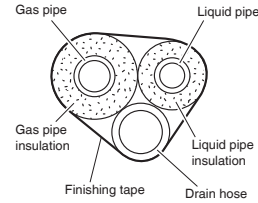

- Be sure to insulate both the gas and liquid piping and observe the insulation dimensions as below.

	Piping size	Minimum bend radius	Piping thickness	Thermal insulation size	Thermal insulation thickness
Gas side	O.D. 3/8 inch (9.5mm)	1-3/16 inch (30mm) or more	0.031 inch (0.8mm) (C1220T-O)	I.D. 15/32-19/32 inch (12-15mm)	13/32 inch (10mm) Min.
	O.D. 1/2 inch (12.7mm)	1-9/16 inch (40mm) or more		I.D. 9/16-5/8 inch (14-16mm)	
Liquid side	O.D. 1/4 inch (6.4mm)	1-3/16 inch (30mm) or more		I.D. 5/16-13/32 inch (8-10mm)	

- Use separate thermal insulation pipes for gas and liquid refrigerant pipes.
- Make absolutely sure to execute thermal insulation works on the pipe-connecting section, after checking for gas leakage, by thoroughly studying the following figures and using the included thermal insulating materials (G) fitting insulation and (H) fitting insulation. Fasten both ends with the (D) clamps.

Piping insulation procedure

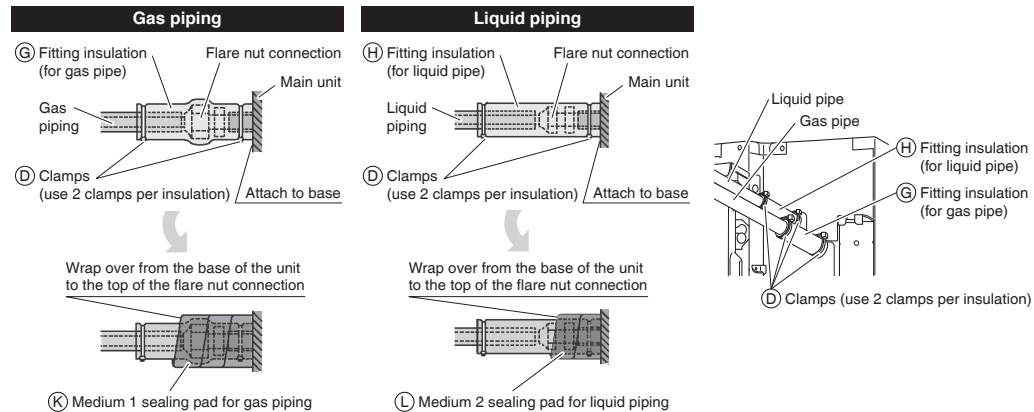

CAUTION

Be sure to insulate any field piping all the way to the piping connection inside the unit. Any exposed piping may cause condensation or burns if touched.

Installation of the Decoration Panel

With the wireless remote controller, field setting and trial operation cannot be performed without attaching the decoration panel.

Read "Trial Operation and Testing" before making a trial operation without attaching the decoration panel.

Refer to the installation manual attached to the decoration panel.

After installing the decoration panel, ensure that there is no space between the unit body and decoration panel.

Field Settings

⚠ CAUTION

When performing field setting or trial operation without attaching the decoration panel, do not touch the drain pump. This may cause electric shock.

- Make sure the electrical wiring box cover is closed on the indoor and outdoor units.
- Field settings must be made from the remote controller and in accordance with installation conditions.
- Setting can be made by changing the “Mode No.,” “FIRST CODE NO.” and “SECOND CODE NO.”.
- The “Field Settings” included with the remote control lists the order of the settings and method of operation.

Field Settings			
Unit No	Mode		
0	20		
0-01	1-01	2-02	3-01
4---	5---	6---	7---
8---	9---	10---	11---
12---	13---	14---	15---
Setting ⏪ ⏩			

1. Setting air outlet direction

- For changing air outlet direction (2 or 3 directions), refer to the installation manual attached to the blocking pad kit (sold separately) or the service manual.
(SECOND CODE NO. is factory set to “01” for air outlet in 4 directions.)

2. Setting for options

- For settings for options, see the installation manual provided with the option.

3. Setting remote controller

When using wireless remote controllers

- When using the wireless remote controllers, wireless remote controller address setting is necessary. Refer to the installation manual attached to the wireless remote controller.

4. Setting air filter sign

- Remote controllers are equipped with liquid crystal display air filter signs to display the time to clean air filters.
- Change the SECOND CODE NO. depending on the amount of dirt or dust in the room.

AIR FILTER CLEANING TIME INDICATOR lamp display interval

Setting content	Contamination	Mode No.	FIRST CODE NO.	SECOND CODE NO.
Approx. 2500 hrs	Contamination-light	10 (20)	0	01
Approx. 1250 hrs	Contamination-heavy			02

AIR FILTER CLEANING TIME INDICATOR lamp display

Setting content	Mode No.	FIRST CODE NO.	SECOND CODE NO.
Display ON	10 (20)	3	01
Display OFF*			02

* Use “Display OFF” setting when cleaning indication is not necessary such as the case of periodical cleaning being carried out.

5. When implementing group control

- When using as a pair unit, you may control up to 16 units with the remote controller.
- In this case, all the indoor units in the group will operate in accordance with the group control remote controller.
- Select a remote controller which matches as many of the functions (swing flap, etc.) in the group as possible.

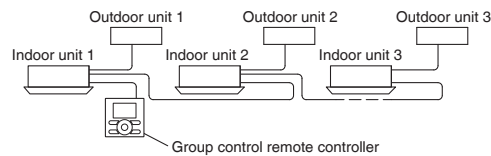

Wiring Method

- 1) Remove the electrical wiring box cover.
(Refer to Wiring between units and ground wire in “6. Wiring” on page 13.)
- 2) Cross-wire the terminal block for remote controller (P1, P2) inside the electrical wiring box. (There is no polarity.)
(Refer to Table 3 in “6. Wiring” on page 12)

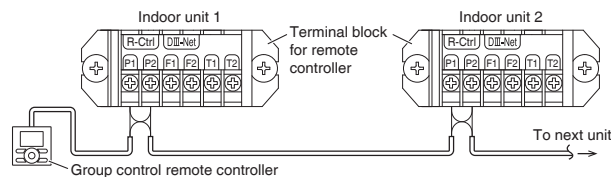

Field Settings

6. 2 remote controllers (controlling 1 indoor unit by 2 remote controllers)

- When using 2 remote controllers, one must be set to "MAIN" and the other to "SUB".

Wiring Method

- Remove the electrical wiring box cover.
(Refer to Wiring between units and ground wire in "6. Wiring" on page 13.)
- Add remote controller 2 to the terminal block for remote controller (P1, P2) in the electrical wiring box. (There is no polarity.)
(Refer to Table 3 in "6. Wiring" on page 12)

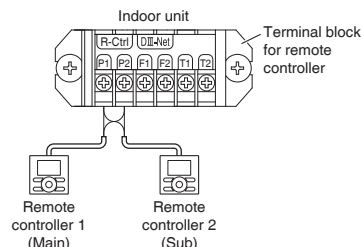

Trial Operation and Testing

⚠ CAUTION

When performing field settings or trial operation without attaching the decoration panel, do not touch the drain pump. This may cause electric shock.

- After finishing the construction of refrigerant piping, drain piping, and electric wiring, conduct trial operation accordingly to protect the unit.

1. Trial operation and testing

Make sure to install the decoration panel before carrying out trial operation if the wireless remote controller is used.

- Trial operation should be carried out in either COOL or HEAT operation.

1-1. Measure the supply voltage and make sure that it is within the specified range.

1-2. In COOL operation, select the lowest programmable temperature;

in HEAT operation, select the highest programmable temperature.

1-3. Carry out the trial operation following the instructions in the operation manual to ensure that all functions and parts, such as the movement of the louvers, are working properly.

- To protect the air conditioner, restart operation is disabled for 3 minutes after the system has been turned off.



1-4. After trial operation is complete, set the temperature to a normal level (78°F to 82°F (26°C to 28°C) in COOL operation, 68°F to 75°F (20°C to 24°C) in HEAT operation).

- When operating the air conditioner in COOL operation in winter, or HEAT operation in summer, set it to the trial operation mode using the following method.

Refer to **For wired remote controller** on page 18.

Refer to **For wireless remote controller**.

For wireless remote controller

- Press  and select the COOL or HEAT operation.
- Press  twice. "Test" is displayed.
- Press  within 10 seconds, and the test operation starts.

Monitor the operation of the indoor unit for a minimum of 10 minutes. During test operation, the indoor unit will continue to cool/heat regardless of the temperature setpoint and room temperature.

- In the case of above-mentioned procedures 1) and 2) in reverse order, test operation can start as well.

- Test operation will stop automatically after 15 - 30 minutes. To stop the operation, press .
- Some of the functions cannot be used in the test operation mode.

For wired remote controller

- 1) Set to COOL or HEAT operation using the remote controller.
- 2) Press and hold Cancel button for 4 seconds or longer. Service settings menu is displayed.
- 3) Select **Test Operation** in the service settings menu, and press Menu/OK button. Basic screen returns and “Test Operation” is displayed at the bottom.
- 4) Press On/Off button within 10 seconds, and the test operation starts.
Monitor the operation of the indoor unit for a minimum of 10 minutes. During test operation, the indoor unit will continue to cool/heat regardless of the temperature setpoint and room temperature.
 - In the case of above-mentioned procedures 3) and 4) in reverse order, test operation can start as well.
- 5) Press Menu/OK button in the basic screen. Main menu is displayed.
- 6) Select **Air Flow Direction** in the main menu and check that air flow direction is actuated according to the setting. For operation of air flow direction setting, see the operation manual.
- 7) After the operation of air flow direction is confirmed, press Menu/OK button. Basic screen returns.
- 8) Press and hold Cancel button for 4 seconds or longer in the basic screen. Service settings menu is displayed.
- 9) Select **Test Operation** in the service settings menu, and press Menu/OK button. Basic screen returns and normal operation is conducted.
 - Test operation will stop automatically after 15-30 minutes. To stop the operation, press On/Off button.
- 10) If the decoration panel has not been installed, turn off the power after the test operation.

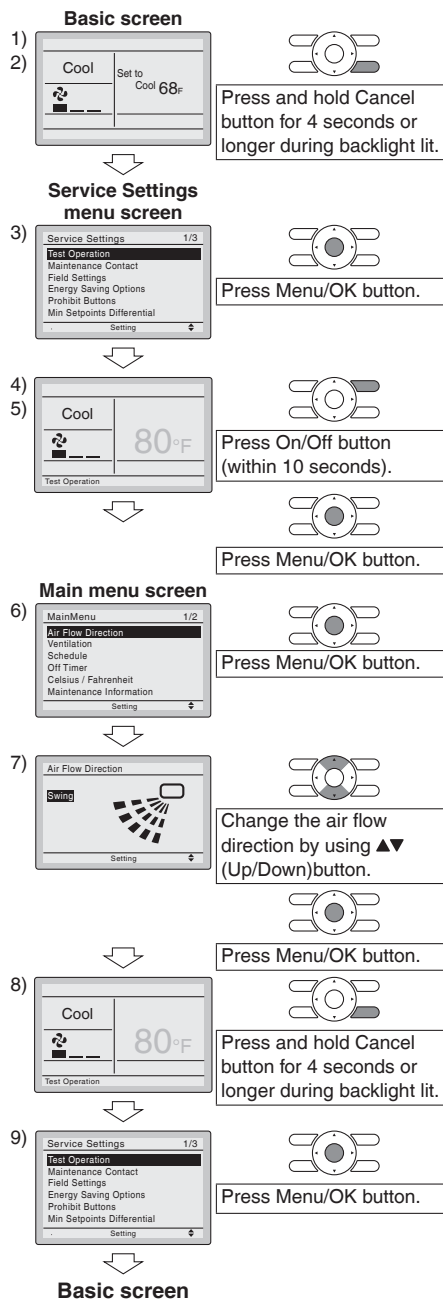

Precautions

Refer to “3. How to diagnose for malfunction” if the unit does not operate properly.

Trial Operation and Testing

2. Test items

Test items	Symptom	Check
Indoor and outdoor units are installed securely.	Fall, vibration, noise	
Is the outdoor unit fully installed?	No operation or burn damage	
No refrigerant gas leaks.	Incomplete cooling/heating function	
Refrigerant gas and liquid pipes and indoor drain hose extension are thermally insulated.	Water leakage	
Draining line is properly installed.	Water leakage	
Does the power supply voltage correspond to that shown on the name plate?	No operation or burn damage	
Only specified wires are used for all wiring, and all wires are connected correctly.	No operation or burn damage	
System is properly grounded.	Electrical leakage	
Is wiring size according to specifications?	No operation or burn damage	
Is something blocking the air outlet or inlet of either the indoor or outdoor units?	Incomplete cooling/heating function	
Are refrigerant piping length and additional refrigerant charge noted down?	The refrigerant charge in the system is not clear	
Pipes and wires are connected to the corresponding connection ports / terminal blocks for the connected unit.	No cooling/heating	
Stop valves are opened.	Incomplete cooling/heating function	
Check that the connector of the lead wires of the decoration panel is connected securely.	Louvers do not move	
Indoor unit properly receives wireless remote control commands.	No operation	

Items to be checked at time of delivery

Also review the "Precautions" on page 3

Test items	Check
Are the electrical wiring box cover, air filter, suction grille attached?	
Did you explain about operations while showing the operation manual to your customer?	
Did you hand the operation manual over to your customer?	

Points for explanation about operations

The items with ⚠ WARNING and ⚠ CAUTION marks in the operation manual are the items pertaining to possibilities for bodily injury and material damage in addition to the general usage of the product. Accordingly, it is necessary that you make a full explanation about the described contents and also ask your customers to read the operation manual.

Note to the installer

Be sure to instruct customers how to properly operate the unit (especially cleaning the filter, operating different functions, and adjusting the temperature) by having them carry out operations while looking at the manual.

3. How to diagnose for malfunction

- If the air conditioner does not operate normally after installing the air conditioner, a malfunction shown in the table below may happen.

Wired remote controller display	Description
No display	<ul style="list-style-type: none"> • Power outage, power voltage error or open-phase • Incorrect wiring (between indoor and outdoor units) • Indoor PC-board assembly failure • Remote controller wiring not connected • Remote controller failure • Open fuse or tripped circuit breaker (outdoor unit)
“Checking the connection. Please stand by.” *	<ul style="list-style-type: none"> • Indoor PC-board assembly failure • Wrong wiring (between indoor and outdoor units)

* “Checking the connection. Please stand by” will be displayed for up to 90 seconds following the application of power to the indoor unit. This is normal and does not indicate a malfunction.

- Diagnose with the display on the liquid crystal display remote controller.

With the wired remote controller

When the operation stops due to a malfunction, operation lamp blinks, and the malfunction code is indicated on the liquid crystal display. In such a case, diagnose the fault contents by referring to **Error History** in the service settings menu. In the case of group control, the unit No. is displayed so that the indoor unit with the trouble can be identified.

With the wireless remote controller

(Refer also to the operation manual attached to the wireless remote controller)

When the operation stops due to a malfunction the display on the indoor unit blinks. In such a case, diagnose the fault contents with the error code which can be found by following procedures.

- 1) Press the INSPECTION/TEST OPERATION button, “” is displayed and “0” blinks.
- 2) Press the TEMPERATURE SETTING button and find the unit No. which stopped due to trouble.

Number of beeps	3 short beeps.....	Perform all the following operations
	1 short beep	Perform (3) and (6)
	1 long beep.....	No trouble
- 3) Press the OPERATION MODE SELECTOR button and upper figure of the error code blinks.
- 4) Continue pressing the TEMPERATURE SETTING button until it makes 2 short beeps and find the upper code.
- 5) Press the OPERATION MODE SELECTOR button and lower figure of the error code blinks.
- 6) Continue pressing the TEMPERATURE SETTING button until it makes a long beep and find the lower code.
 - A long beep indicate the error code.

12.4 RX09/12

Contents

Safety Considerations	1	4. Refrigerant piping	6
Accessories	3	5. Pressure test and evacuating system.....	7
Precautions for Selecting a Location	3	6. Refilling refrigerant	8
Precautions on Installation	4	Wiring	9
Outdoor Unit Installation Diagram	4	Facility Setting	
Installation Space Requirements	5	(cooling at low outdoor temperature)	10
Outdoor Unit Installation	5	When Attaching the Drain Pan Heater	11
1. Installing the outdoor unit	5	Pump Down Operation	12
2. Drain work	5	Trial Operation and Testing	13
3. Flaring the pipe end.....	6	1. Trial operation and testing	13
		2. Test items	13

The pictures in this document are for illustrative purposes only.

Safety Considerations

Refer also to the General Safety Considerations in the separate booklet.

Read the precautions in this manual carefully before operating the unit.

Read these **Safety Considerations for Installation** carefully before installing an air conditioner or heat pump. After completing the installation, make sure that the unit operates properly during the startup operation.

Instruct the user on how to operate and maintain the unit. Inform users that they should store this installation manual with the operation manual for future reference.

Always use a licensed installer or contractor to install this product. Improper installation can result in water or refrigerant leakage, electric shock, fire, or explosion.

Meanings of **DANGER**, **WARNING**, **CAUTION**, and **NOTE**

Symbols:

- DANGER**
- WARNING**
- CAUTION**
- NOTE**

DANGER _____

- Refrigerant gas is heavier than air and replaces oxygen. A massive leak can lead to oxygen depletion, especially in basements, and an asphyxiation hazard could occur leading to serious injury or death.
- Do not ground units to water pipes, gas pipes, telephone wires, or lightning rods as incomplete grounding can cause a severe shock hazard resulting in severe injury or death. Additionally, grounding to gas pipes could cause a gas leak and potential explosion causing severe injury or death.

- If refrigerant gas leaks during installation, ventilate the area immediately. Refrigerant gas may produce toxic gas if it comes into contact with fire. Exposure to this gas could cause severe injury or death.
- After completing the installation work, check that the refrigerant gas does not leak throughout the system.
- Do not install unit in an area where flammable materials are present due to risk of explosions that can cause serious injury or death.
- Safely dispose all packing and transportation materials in accordance with federal/state/local laws or ordinances. Packing materials such as nails and other metal or wood parts, including plastic packing materials used for transportation may cause injury or death by suffocation.

WARNING _____

- Only qualified personnel licensed or certified in their jurisdiction must carry out the installation work. Installation must be done in accordance with this installation manual. Improper installation may result in water leakage, electric shock, or fire.
- When installing the unit in a small room, take measures to keep the refrigerant concentration from exceeding allowable safety limits. Excessive refrigerant leaks, in the event of an accident in a closed ambient space, can lead to oxygen deficiency.
- Use only specified accessories and parts for installation work. Failure to use specified parts may result in water leakage, electric shock, fire, or the unit falling.
- Install the air conditioner or heat pump on a foundation strong enough that it can withstand the weight of the unit. A foundation of insufficient strength may result in the unit falling and causing injury.
- Take into account strong winds, typhoons, or earthquakes when installing. Improper installation may result in the unit falling and causing accidents.
- Make sure that a separate power supply circuit is provided for this unit and that all electrical work is carried out by qualified personnel licensed or certified in their jurisdiction according to local, state, and national regulations. An insufficient power supply capacity or improper electrical construction may lead to electric shock or fire.

- Make sure that all wiring is secured, that specified wires are used, and that no external forces act on the terminal connections or wires. Improper connections or installation may result in fire.
- When wiring, position the wires so that the protection plate can be securely fastened. Improper positioning of the protection plate may result in electric shock, fire, or the terminals overheating.
- Before touching electrical parts, turn off the unit.
- The circuit must be protected with safety devices in accordance with local and national codes, i.e. a circuit breaker.
- Securely fasten the outdoor unit protection plate. If the protection plate is not installed properly, dust or water may enter the outdoor unit causing fire or electric shock.
- When installing or relocating the system, keep the refrigerant circuit free from substances other than the specified refrigerant (R410A) such as air. Any presence of air or other foreign substance in the refrigerant circuit can cause an abnormal pressure rise or rupture, which may result in equipment damage and even injury.
- Do not change the setting of the protection devices. If the pressure switch, thermal switch, or other protection device is shorted and operated forcibly, or parts other than those specified by Daikin are used, fire or explosion may occur.
- Do not use means to accelerate the defrosting process (if possible) or to clean, other than those recommended by the manufacturer.
- The appliance must be stored in a room without continuously operating ignition sources (for example: open flames, an operating gas appliance or an operating electric heater).
- Do not pierce or burn.
- Be aware that refrigerants may not contain an odor.
- Comply with national gas regulations.

CAUTION

- Do not touch the switch with wet fingers. Touching a switch with wet fingers can cause electric shock.
- Do not allow children to play on or around the unit to prevent injury.
- Wear adequate personal protective equipment (protective gloves, safety glasses,...) when installing, maintaining or servicing the system.
- The heat exchanger fins are sharp enough to cut. To avoid injury, wear gloves or cover the fins while working around them.
- Do not touch the refrigerant pipes during and immediately after operation as the refrigerant pipes may be hot or cold, depending on the condition of the refrigerant flowing through the refrigerant piping, compressor, and other refrigerant cycle parts. Your hands may suffer burns or frostbite if you touch the refrigerant pipes. To avoid injury, give the pipes time to return to normal temperature or, if you must touch them, be sure to wear proper gloves.
- Install drain piping to ensure proper drainage. Improper drain piping may result in water leakage and property damage.
- Insulate piping to prevent condensation.
- Be careful when transporting the product.
- Do not turn off the power immediately after stopping operation. Always wait for at least 5 minutes before turning off the power. Otherwise, water leakage may occur.
- Do not use a charging cylinder. Using a charging cylinder may cause the refrigerant to deteriorate.
- Refrigerant R410A in the system must be kept clean, dry, and tight.
 - (a) Clean and Dry -- Foreign materials (including mineral oils such as SUNISO oil or moisture) should be prevented from getting into the system.



- (b) Tight -- R410A does not contain any chlorine, does not destroy the ozone layer, and does not reduce the earth's protection against harmful ultraviolet radiation. R410A can contribute to the greenhouse effect if it is released. Therefore take proper measures to check for the tightness of the refrigerant piping installation. Read the chapter *Refrigerant Piping* and follow the procedures.
- Since R410A is a blend, the required additional refrigerant must be charged in its liquid state. If the refrigerant is charged in a state of gas, its composition can change and the system will not work properly.
 - The outdoor unit is for R410A. See the catalog for indoor models that can be connected. Normal operation is not possible when connected to non-compatible indoor units.
 - Remote controller (wireless kit) transmitting distance can be shorter than expected in rooms with electronic fluorescent lamps (inverter or rapid start types). Install the indoor unit far away from fluorescent lamps as much as possible.
 - Indoor units are for indoor installation only. Outdoor units can be installed either outdoors or indoors.
 - Do not install the air conditioner or heat pump in the following locations:
 - (a) Where a mineral oil mist or oil spray or vapor is produced, for example, in a kitchen. Plastic parts may deteriorate and fall off or result in water leakage.
 - (b) Where corrosive gas, such as sulfurous acid gas, is produced. Corroding copper pipes or soldered parts may result in refrigerant leakage.
 - (c) Near machinery emitting electromagnetic waves. Electromagnetic waves may disturb the operation of the control system and cause the unit to malfunction.
 - (d) Where flammable gas may leak, where there is carbon fiber, or ignitable dust suspension in the air, or where volatile flammables such as thinner or gasoline are handled. Operating the unit in such conditions can cause a fire.
 - Take adequate measures to prevent the outdoor unit from being used as a shelter by small animals. Small animals making contact with electrical parts can cause malfunctions, smoke, or fire. Instruct the user to keep the area around the unit clean.
 - Servicing shall be performed only as recommended by the manufacturer and licensed or certified in their jurisdiction.

NOTE

- The outdoor unit should be positioned where the unit and power supply wires (breaker panel to outdoor unit) are at least 10ft (3m) away from any televisions or radios. (The unit may cause interference with the picture or sound.) Depending on the radio waves, a distance of 10ft (3m) may not be sufficient to eliminate the noise.
- Dismantling the unit, treatment of the refrigerant, oil and additional parts must be done in accordance with the relevant local, state, and national regulations.
- Only use tools for R410A, such as a gauge manifold, charge hose, gas leak detector, reverse flow check valve, refrigerant charge base, vacuum gauge, or refrigerant recovery equipment.
- If the conventional refrigerant and refrigerator oil are mixed in R410A, the refrigerant may deteriorate.
- This air conditioner or heat pump is an appliance that should not be accessible to the general public.
- As maximum allowable pressure is 604psi (4.17MPa), the wall thickness of field-installed pipes should be selected in accordance with the relevant local, state, and national regulations.

RN006-U

Accessories

<p>(A) Installation manual</p>	<p>1</p>	<p>(B) Drain socket</p>  <p>This is at the bottom of the packaging.</p>	<p>1</p>
<p>(C) Drain cap (1)</p> 	<p>4</p>	<p>(D) Drain cap (2)</p> 	<p>2</p>
<p>(E) Warranty</p>	<p>1</p>	<p>(F) General safety consideration</p>	<p>1</p>

Precautions for Selecting a Location

- 1) Choose a place solid enough to bear the weight and vibration of the unit, where the operating sound will not be amplified.
- 2) Choose a location where the air discharged from the unit or the operating sound will not cause a nuisance to the neighbors of the user.
- 3) Avoid locations, such as near bedrooms, where the operating sound may cause disturbance.
- 4) There must be sufficient space to carry the unit into and out of the site.
- 5) There must be sufficient space for air passage and no obstructions around the air inlet and the air outlet.
- 6) The site must not be prone to flammable gas leaks in the surrounding area.
- 7) In coastal areas or other places with a salty atmosphere or one containing sulfate gas, corrosion may shorten the life of the air conditioner.
- 8) Since water will flow from the drain of the outdoor unit, do not place anything under the unit which must be kept away from moisture.
- 9) A location where flammable gas does not leak. Position at least 6-5/8ft (2m) from propane gas cylinders.

NOTE

Cannot be installed suspended from a ceiling or stacked.

CAUTION

When operating the air conditioner in a low outdoor ambient temperature, be sure to follow the instructions described below.

- To prevent exposure to wind, install the outdoor unit with its suction side facing the wall.
- Never install the outdoor unit at a site where the suction side may be exposed directly to wind.
- To prevent exposure to wind, it is recommended to install a baffle plate on the air discharge side of the outdoor unit.
- In heavy snow areas, select an installation site where the snow will not affect the unit.
- If there is a likelihood of snow accumulating on the outdoor unit, attach a snow protection hood.
- In high humidity areas or heavy snow areas, it is recommended to attach a drain pan heater to prevent ice build-up from the bottom frame.

- Construct a large canopy.
- Construct a pedestal.



Install the unit high enough off the ground to prevent burying in snow.

Precautions on Installation

- Check the strength and level of the installation surface so that the unit does not cause any operating vibrations or noise after installation.
- Fix the unit in place securely using foundation bolts, as in the figure. (Prepare 4 sets of 5/16 inch (M8) or 3/8 inch (M10) foundation bolts, nuts and washers; all sold separately.)
- It is best to screw in the foundation bolts until their ends are 3/4 inch (20mm) from the foundation surface.

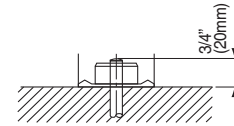

Outdoor Unit Installation Diagram

Max. allowable piping length	65-5/8ft (20m)
Min. allowable piping length	10ft (3m)
Max. allowable piping height	49-1/4ft (15m)
Additional refrigerant required for refrigerant pipe exceeding 32-3/4ft (10m) in length.	0.21oz/ft (20g/m)
Gas pipe	O.D. 3/8 inch (9.5mm)
Liquid pipe	O.D. 1/4 inch (6.4mm)

Refrigerant piping must be kept to a minimum.
 *Be sure to add the proper amount of additional refrigerant.
 Failure to do so may result in reduced performance.
 **The suggested shortest pipe length is 10ft (3m), in order to avoid noise from the outdoor unit and vibration.
 (Mechanical noise and vibration may occur depending on how the unit is installed and the environment in which it is used.)

If strong wind blows into the air discharge side from the front and there is a danger that the fan may be damaged, change the orientation of the air discharge side of the outdoor unit or use an air direction adjustment grille (sold separately).

In sites with poor drainage, use block bases for the outdoor unit. Adjust foot height until the unit is level. Otherwise, water leakage or pooling of water may occur.

Allow 11-13/16 (300) of work space below the ceiling surface.

Refrigerant piping must be protected from physical damage. Install a plastic cover or equivalent.

Wrap the insulation pipe with finishing tape from bottom to top.

CAUTION
 Keep the piping length between 10ft (3m) and 65-5/8ft (20m)

Stop valve cover
How to remove the stop valve cover
 1) Remove the screw on the stop valve cover.
 2) Slide the stop valve cover downward to remove it.
How to attach the stop valve cover
 1) Insert the upper part of the stop valve cover into the outdoor unit.
 2) Tighten the screw.

Allow space for piping and electrical servicing.

If there is a danger of the unit falling or overturning, fix the unit with foundation bolts, or with wire or other means.

unit: inch (mm)

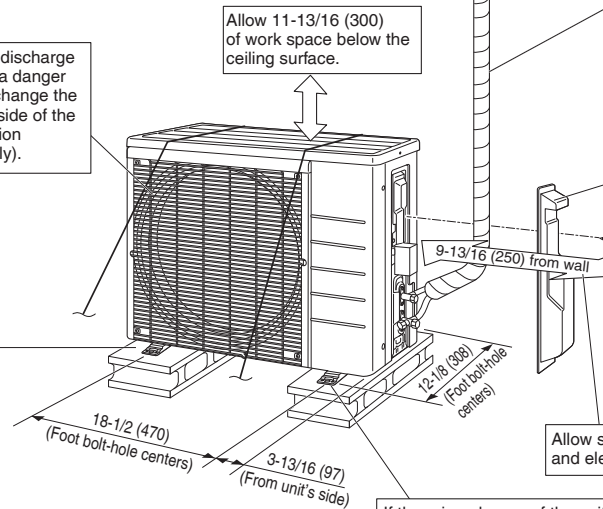

Installation Space Requirements

- Position the unit on a horizontal surface. Any tilt in the unit should be 3° or less to the horizontal.
- Where a wall or other obstacle is in the path of the outdoor unit's intake or exhaust airflow, follow the installation space requirements below.
- For any of the below installation patterns, the wall height on the outlet side should be 47-1/4 inch (1200mm) or less.
- Secure as much installation space around the unit as the location allows, as more space will result in more efficient operation.

Wall facing one side

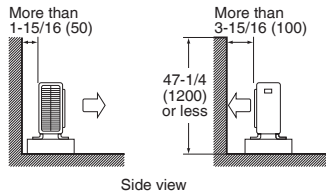

Walls facing two sides

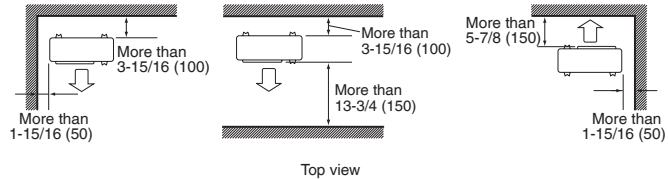

Walls facing three sides

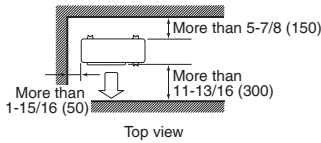

When installed as in the figure on the left, it is recommended to either change the orientation of the outdoor unit outlet side or use the air direction adjustment grille (sold separately).

unit: inch (mm)

Outdoor Unit Installation

1. Installing the outdoor unit

- When installing the outdoor unit, refer to "Precautions for Selecting a Location" on page 3 and the "Outdoor Unit Installation Diagram" on page 4.
- If drain work is necessary, follow the procedures below.

2. Drain work

⚠ CAUTION

In cold areas, do not use a drain socket, drain caps (1, 2) and a drain hose with the outdoor unit. (Drain water may freeze, impairing heating performance.)

- If the drain port is covered by a mounting base or floor surface, place additional foot bases of at least 1-1/4 inch (30mm) in height under the outdoor unit's feet.
- 1) Attach ① drain cap (1) and ② drain cap (2).
 - 2) Attach ③ drain socket.
 - When attaching ③ drain socket to the bottom frame, make sure to connect the drain hose to the drain socket first.

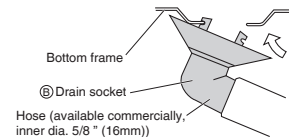
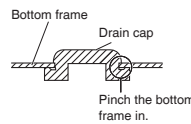
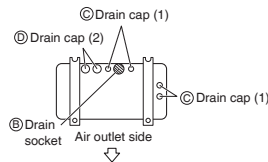

3. Flaring the pipe end

⚠ WARNING

- Do not apply mineral oil to the flare.
- Prevent mineral oil from getting into the system as this would reduce the service life of the units.
- Never use piping which has been used for previous installations. Only use parts which are delivered with this unit.
- Never install a dryer to this R410A unit in order to guarantee its service life.
- The drying material may dissolve and damage the system.
- Improper flaring may result in refrigerant gas leakage.

⚠ CAUTION

Do not reuse joints which have been used once already.

- 1) Cut the pipe end with a pipe cutter.
- 2) Remove burrs with the cut surface facing downward, so that the filings do not enter the pipe.
- 3) Put the flare nut on the pipe.
- 4) Flare the pipe.
- 5) Check that the flaring has been done correctly.

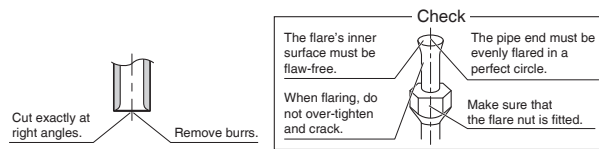

Flaring

Set exactly at the position shown below.

Die	Flare tool for R410A			Conventional flare tool	
	Clutch-type	Clutch-type (Rigid-type)	Wing-nut type (Imperial-type)		
A	0-0.020 inch (0-0.5mm)	0.039-0.059 inch (1.0-1.5mm)	0.059-0.079 inch (1.5-2.0mm)		

4. Refrigerant piping

⚠ CAUTION

- Use the flare nut fixed to the main unit. (This is to prevent the flare nut from cracking as a result of deterioration over time.)
 - To prevent gas leakage, apply refrigeration oil only to the inner surface of the flare. (Use refrigeration oil for R410A.)
 - Use a torque wrench when tightening the flare nuts to prevent damage to the flare nuts and gas leakage.
- Align the centers of both flares and tighten the flare nuts 3 or 4 turns by hand, then tighten them fully with a spanner and a torque wrench.

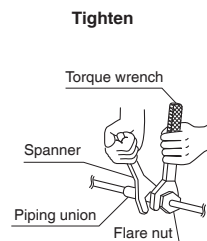
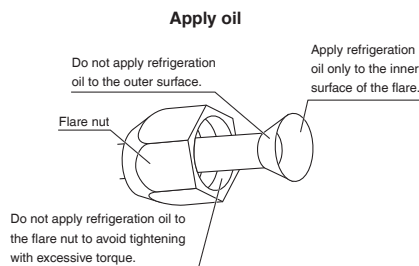

Tightening torque

Piping connection

Flare nut	
Gas side	Liquid side
3/8 inch (9.5mm)	1/4 inch (6.4mm)
24-1/8 – 29-1/2 lbf • ft (32.7-39.9N • m)	10-1/2 – 12-3/4 lbf • ft (14.2-17.2N • m)

Valve cap

Width across flats	
11/16 inch (17mm)	3/4 inch (19mm)
10-1/2 – 12-5/8 lbf • ft (14.2-17.2N • m)	12-5/8 – 15-3/8 lbf • ft (17.0-21.0N • m)

Service port cap

8 – 10-7/8 lbf • ft (10.7-14.7N • m)

Outdoor Unit Installation

Cautions on pipe handling

- Protect the open end of the pipe from dust and moisture.
- All pipe bends should be as gentle as possible. Use a pipe bender for bending.

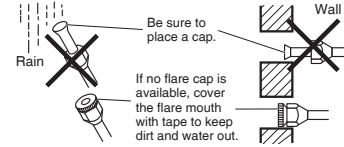

Selection of copper and heat insulation materials

When using commercial copper pipes and fittings, observe the following:

- Insulation material: Polyethylene foam
Heat transfer rate: 0.041 to 0.052W/mK (0.024 to 0.030Btu/ft²h°F) (0.035 to 0.045kcal/mh°C)
Be sure to use insulation that is designed for use with HVAC Systems.
- ACR Copper only.
- Be sure to insulate both the gas and liquid piping and observe the insulation dimensions as below.

	Piping size	Minimum bend radius	Piping thickness	Thermal insulation size	Thermal insulation thickness
Gas side	O.D. 3/8 inch (9.5mm)	1-3/16 inch (30mm) or more	0.031 inch (0.8mm) (C1220T-O)	I.D. 15/32-19/32 inch (12-15mm)	13/32 inch (10mm) Min.
Liquid side	O.D. 1/4 inch (6.4mm)	1-3/16 inch (30mm) or more	0.031 inch (0.8mm) (C1220T-O)	I.D. 5/16-13/32 inch (8-10mm)	

- Use separate thermal insulation pipes for gas and liquid refrigerant pipes.
- Using finishing tape, bundle and wrap the indoor unit piping and drain hose together so that the drain hose is below the other piping.

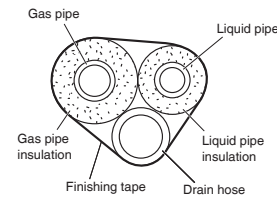

5. Pressure test and evacuating system

⚠ WARNING

- Make sure that air or any matter other than refrigerant (R410A) does not get into the refrigeration cycle.
- If refrigerant gas leaks should occur, ventilate the room as soon and as much as possible.
- R410A, as well as other refrigerants, should always be recovered and never be released directly into the environment.
- Use a vacuum pump for R410A exclusively. Using the same vacuum pump for different refrigerants may damage the vacuum pump or the unit.

⚠ CAUTION

It is highly recommended that you do not open/close the stop valves when the outdoor temperature is below -5°F (-21°C) as this may result in refrigerant leakage.

- When piping work is complete, it is necessary to perform a pressure test and evacuate system with a vacuum pump.
- If using additional refrigerant, purge the air from the refrigerant pipes and indoor unit using a vacuum pump, then charge additional refrigerant.
- Use a hexagonal wrench (3/16 inch (4mm)) to operate the stop valve rod.
- All refrigerant pipe joints should be tightened with a torque wrench to the specified tightening torque.

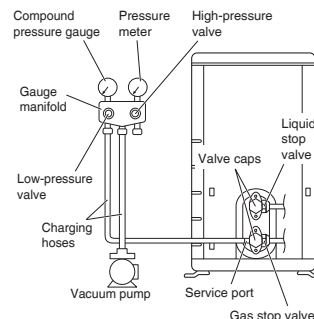

- 1) Pressurize the liquid pipe and gas pipe from the service ports of each stop valve to 604psi (4.17MPa) (do not pressurize more than 604psi (4.17MPa)) for 1 hour minimum, 24 hours recommended. If there is a pressure drop, check for leaks, make repairs and perform the pressure test again.
- 2) Connect the gauge manifold's charging hose to the gas stop valve's service port.
- 3) Fully open the low-pressure valve (Lo) on the gauge manifold and fully close the high-pressure valve (Hi). (High-pressure valve will require no further operation.)
- 4) Evacuate system using vacuum pump to below 500 microns for 1 hour minimum.
- 5) Close the low-pressure valve (Lo) on the gauge manifold and stop vacuum pumping. (Maintain this condition for a few minutes to make sure that the compound pressure gauge pointer does not swing back.)*1
- 6) Remove the valve caps from the liquid stop valve and gas stop valve.
- 7) To open the liquid stop valve, turn the rod of the valve 90° counter-clockwise using a hexagonal wrench. Close it after 5 seconds, and check for gas leakage. Using soapy water, check for gas leakage from the indoor unit's flare and outdoor unit's flare and valve rods. After the check is complete, wipe all soapy water off.
- 8) Disconnect the charging hoses from the service port for the gas stop valve, then fully open the liquid and gas stop valves. (Do not attempt to turn the valve rods further than they can go.)
- 9) Tighten the valve caps and service port caps for the liquid and gas stop valves with a torque wrench to the specified torques. Refer to "4. Refrigerant piping" on page 6 for details.

*1 If the compound pressure gauge pointer swings back, the refrigerant may have water content or there may be a loose pipe joint. Check all pipe joints and retighten nuts as needed, then repeat steps 3) through 5).

6. Refilling refrigerant

Check the type of refrigerant to be used on the machine nameplate.

Precautions when adding R410A

Fill from the liquid pipe in liquid form.

R410A is a mixed refrigerant, so adding it in gas form may cause the refrigerant composition to change, preventing normal operation.

- Before filling, check whether the cylinder has a siphon attached or not. (It should have something like "liquid filling siphon attached" displayed on it.)

Filling a cylinder with an attached siphon



Stand the cylinder upright when filling.

(There is a siphon pipe inside, so the cylinder need not be upside-down to fill with liquid.)

Filling other cylinders



Turn the cylinder upside-down when filling.

- Be sure to use the R410A tools to ensure pressure and to prevent foreign objects from entering.

Wiring

⚠ WARNING

- Do not ground units to water pipes, gas pipes, telephone wires, or lightning rods as incomplete grounding can cause a severe shock hazard resulting in severe injury or death. Additionally, grounding to gas pipes could cause a gas leak and potential explosion causing severe injury or death.
- Do not use tapped wires, extension cords, or starburst connections, as they may cause overheating, electric shock, or fire.
- Do not use locally purchased electrical parts inside the product. (Do not branch the power for the drain pump, etc., from the terminal block.) Doing so may cause electric shock or fire.
- The circuit must be protected with safety devices in accordance with local and national codes, i.e. a circuit breaker.
- Use an all-pole disconnection type circuit breaker with at least 1/8 inch (3mm) between the contact point gaps.
- When carrying out wiring, take care not to pull at the conduit.
- Do not connect the power wire to the indoor unit. Doing so may cause electric shock or fire.
- Do not turn on the circuit breaker until all work is completed.

⚠ CAUTION

Precautions to be taken for power supply wiring

Recommend stranded cable for interunit wiring. Local code always supersedes recommendation.

- For stranded wires, make sure to use the round crimp-style terminal for connection to the power supply terminal block. Place the round crimp-style terminals on the wires up to the covered part and secure in place.

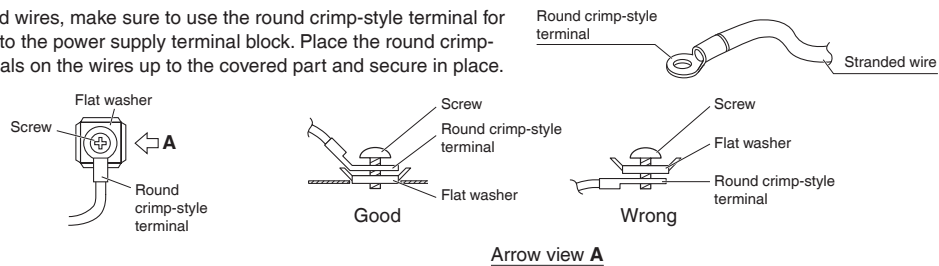

- If solid core wire must be used, be sure to curl the end of the lead. Improper work may cause heat and fire.

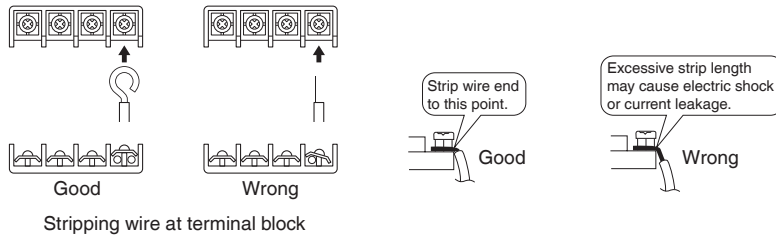

- 1) Strip the insulation from the wire (3/4 inch (20mm)).
- 2) Connect the inter-unit wires between the indoor and outdoor units so that the terminal numbers match. Tighten the terminal screws securely. It is recommended that a slot-head screwdriver be used to tighten the screws.

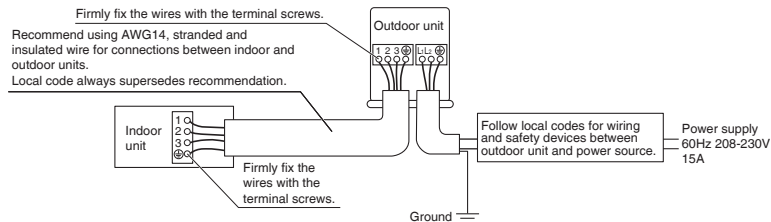

NOTE

Take care to ensure that all wiring between indoor unit and outdoor unit has a consistent connection. Any splices can cause communication errors.

[Method of mounting conduit]

- A protection plate is fixed for protection from the high-voltage section.
- 1) Dismount the stop valve cover by removing the screw.
 - 2) Dismount the protection plate by removing the 2 screws.
 - 3) Dismount the conduit mounting cover by removing the 2 screws.
 - 4) Pass wires through the conduit and secure them with a lock nut.
 - 5) After completing the work, reattach the conduit mounting cover, the protection plate, and the stop valve cover to its original position.

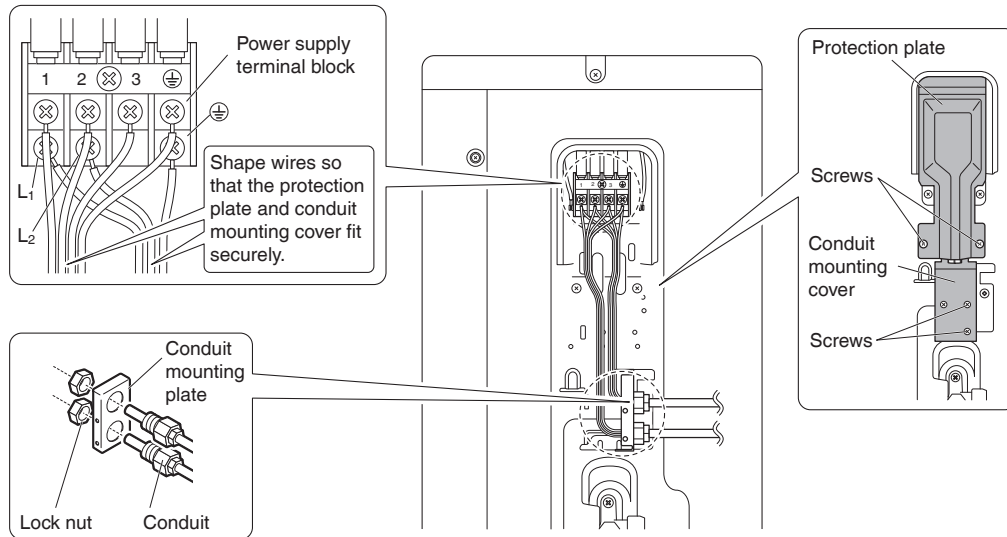

Ground

This air conditioner must be grounded. For grounding, follow all local, and state electrical codes.

Facility Setting (cooling at low outdoor temperature)

⚠ WARNING

Make sure to turn the power OFF before performing work.

⚠ CAUTION

- If the outdoor unit is installed where the heat exchanger of the unit is exposed to direct wind, provide a windbreak wall.
- Intermittent noises may be produced by the indoor unit due to the outdoor fan turning on and off when using facility settings.
- Do not place humidifiers or other items which might raise the humidity in rooms where facility settings are being used. A humidifier might cause dew condensation from the indoor unit outlet vent.
- Cutting the jumper 6 (J6) sets the indoor fan tap to the highest position. Notify the user about this.

Facility Setting (cooling at low outdoor temperature)

This function is designed for facilities such as equipment or computer rooms. It is never to be used in a residence or office where people occupy the space.

- Cutting the jumper 6 (J6) on the circuit board will expand the operation range down to 14°F (−10°C).

Installing an air direction adjustment grille (sold separately) will further extend the operation range to −4°F (−20°C). In these cases, the unit will stop operating if the outdoor temperature falls below −4°F (−20°C), restarting once the temperature rises above this level.

- 1) Remove the top plate of the outdoor unit. (4 screws)
- 2) Remove the front plate. (5 screws)
- 3) Cut the jumper (J6) of the PCB inside.

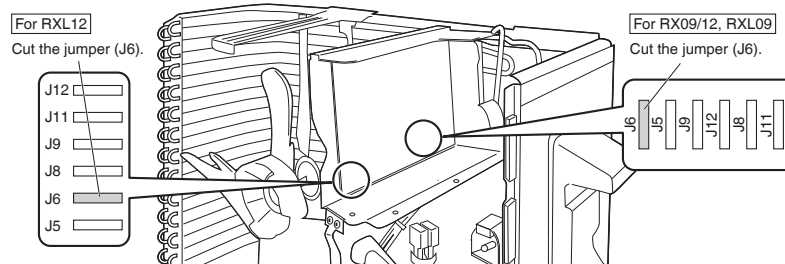

When Attaching the Drain Pan Heater

⚠ WARNING

- Make sure to turn the power OFF before performing work.

In high humidity areas or heavy snow areas, it is recommended to attach a drain pan heater to prevent ice build-up from the bottom frame.

- 1) Attach the drain pan heater in accordance with the installation manual included with the drain pan heater.
- 2) Cut the jumper (J9) of the PCB inside.

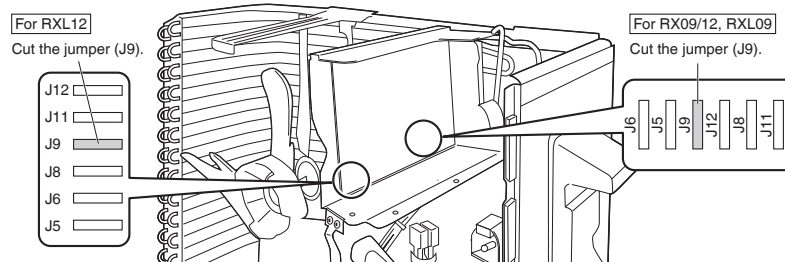

Pump Down Operation

In order to protect the environment, be sure to pump down when relocating or disposing of the unit.

- 1) Remove the valve caps from the liquid stop valve and gas stop valve.
- 2) Begin forced cooling operation.
- 3) After 5 to 10 minutes, close the liquid stop valve with a hexagonal wrench.
- 4) After 2 to 3 minutes, close the gas stop valve and stop forced cooling operation.
- 5) Attach the valve caps once procedures are complete.

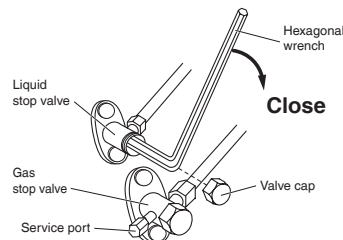

Forced cooling operation

■Using the indoor unit ON/OFF switch

[For FTX, FTXR and FVX models]

Press the indoor unit ON/OFF switch for at least 5 seconds. (The operation will start.)

- Forced cooling operation will stop automatically after about 15 minutes. To stop the operation, press the indoor unit ON/OFF switch.

■Using the indoor unit's remote controller

[For FTX models]

- 1) Press , and at the same time.
- 2) Press , then select , press .
- 3) Press to turn on the system.

- Forced cooling operation will stop automatically after about 30 minutes. To stop the operation, press .

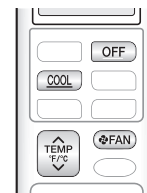

[For FTXR and FVX models]

- 1) Press , and at the same time.
- 2) Press , select “ ”, and press for confirmation.
- 3) Press and select the COOL operation.
- 4) Press to turn on the system.

- Forced cooling operation will stop automatically after about 30 minutes. To stop the operation, press .



[For FFQ and FDMQ models]



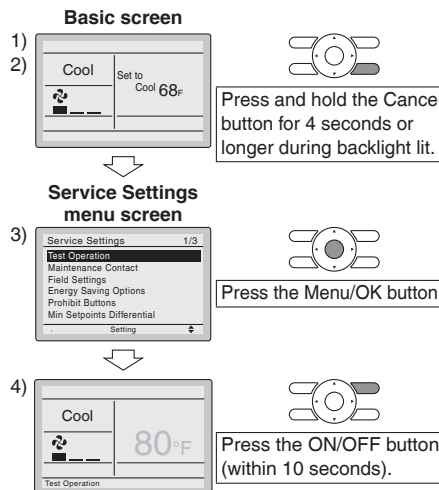

[For wired remote controller]

- 1) Set to COOL operation using the remote controller.
- 2) Press and hold the Cancel button for 4 seconds or longer. Service settings menu is displayed.
- 3) Select **Test Operation** in the service settings menu, and press the Menu/OK button. Basic screen returns and “Test Operation” is displayed at the bottom.
- 4) Press the ON/OFF button within 10 seconds, and the forced cooling operation starts.
 - Forced cooling operation will stop automatically after about 15 minutes. To stop the operation, press the ON/OFF button.



Pump Down Operation

[For wireless remote controller]

- 1) Press  and select the COOL operation.
 - 2) Press  twice. "Test" is displayed.
 - 3) Press  within 10 seconds, and the forced cooling operation starts.
- Forced cooling operation will stop automatically after about 15 minutes.
- To stop the operation, press .

Trial Operation and Testing

1. Trial operation and testing

Refer to the installation manual for the indoor unit.

2. Test items

Test items	Symptom	Check
Indoor and outdoor units are installed securely.	Fall, vibration, noise	
No refrigerant gas leaks.	Incomplete cooling/heating function	
Refrigerant gas and liquid pipes and indoor drain hose extension are thermally insulated.	Water leakage	
Draining line is properly installed.	Water leakage	
System is properly grounded.	Electrical leakage	
Only specified wires are used for all wiring, and all wires are connected correctly.	No operation or burn damage	
Indoor or outdoor unit's air inlet or air outlet are unobstructed.	Incomplete cooling/heating function	
Stop valves are opened.	Incomplete cooling/heating function	
[For FFQ models] Check that the connector of the lead wires of the decoration panel is connected securely.	Louvers do not move	
Indoor unit properly receives remote control commands.	No operation	

12.5 RX15/18/24

Contents

Safety Considerations	1	4. Refrigerant piping	6
Accessories	3	5. Pressure test and evacuating system.....	7
Precautions for Selecting a Location	3	6. Refilling refrigerant	8
Precautions on Installation	4	Wiring	9
Outdoor Unit Installation Diagram	4	Facility Setting	
Installation Space Requirements	5	(cooling at low outdoor temperature)	11
Outdoor Unit Installation	5	When attaching the drain pan heater	12
1. Installing the outdoor unit	5	Pump Down Operation	13
2. Drain work (Only for heat pump models).....	5	Trial Operation and Testing	14
3. Flaring the pipe end.....	6	1. Trial operation and testing	14
		2. Test items	14

The pictures in this document are for illustrative purposes only.

Safety Considerations

Refer also to the General Safety Considerations in the separate booklet.





Read the precautions in this manual carefully before operating the unit.

Read these **Safety Considerations for Installation** carefully before installing an air conditioner or heat pump. After completing the installation, make sure that the unit operates properly during the startup operation.

Instruct the user on how to operate and maintain the unit. Inform users that they should store this installation manual with the operation manual for future reference.

Always use a licensed installer or contractor to install this product. Improper installation can result in water or refrigerant leakage, electric shock, fire, or explosion.

Meanings of **DANGER**, **WARNING**, **CAUTION**, and **NOTE** Symbols:

-  **DANGER**
-  **WARNING**
-  **CAUTION**
-  **NOTE**

-  **DANGER**
- Refrigerant gas is heavier than air and replaces oxygen. A massive leak can lead to oxygen depletion, especially in basements, and an asphyxiation hazard could occur leading to serious injury or death.
- Do not ground units to water pipes, gas pipes, telephone wires, or lightning rods as incomplete grounding can cause a severe shock hazard resulting in severe injury or death. Additionally, grounding to gas pipes could cause a gas leak and potential explosion causing severe injury or death.

- If refrigerant gas leaks during installation, ventilate the area immediately. Refrigerant gas may produce toxic gas if it comes into contact with fire. Exposure to this gas could cause severe injury or death.
- After completing the installation work, check that the refrigerant gas does not leak throughout the system.
- Do not install unit in an area where flammable materials are present due to risk of explosions that can cause serious injury or death.
- Safely dispose all packing and transportation materials in accordance with federal/state/local laws or ordinances. Packing materials such as nails and other metal or wood parts, including plastic packing materials used for transportation may cause injury or death by suffocation.

 **WARNING**

- Only qualified personnel licensed or certified in their jurisdiction must carry out the installation work. Installation must be done in accordance with this installation manual. Improper installation may result in water leakage, electric shock, or fire.
- When installing the unit in a small room, take measures to keep the refrigerant concentration from exceeding allowable safety limits. Excessive refrigerant leaks, in the event of an accident in a closed ambient space, can lead to oxygen deficiency.
- Use only specified accessories and parts for installation work. Failure to use specified parts may result in water leakage, electric shock, fire, or the unit falling.
- Install the air conditioner or heat pump on a foundation strong enough that it can withstand the weight of the unit. A foundation of insufficient strength may result in the unit falling and causing injury.
- Take into account strong winds, typhoons, or earthquakes when installing. Improper installation may result in the unit falling and causing accidents.
- Make sure that a separate power supply circuit is provided for this unit and that all electrical work is carried out by qualified personnel licensed or certified in their jurisdiction according to local, state, and national regulations. An insufficient power supply capacity or improper electrical construction may lead to electric shock or fire.

- Make sure that all wiring is secured, that specified wires are used, and that no external forces act on the terminal connections or wires. Improper connections or installation may result in fire.
- When wiring, position the wires so that the service lid can be securely fastened. Improper positioning of the service lid may result in electric shock, fire, or the terminals overheating.
- Before touching electrical parts, turn off the unit.
- The circuit must be protected with safety devices in accordance with local and national codes, i.e. a circuit breaker.
- Securely fasten the outdoor unit service lid. If the service lid is not installed properly, dust or water may enter the outdoor unit causing fire or electric shock.
- When installing or relocating the system, keep the refrigerant circuit free from substances other than the specified refrigerant (R410A) such as air. Any presence of air or other foreign substance in the refrigerant circuit can cause an abnormal pressure rise or rupture, which may result in equipment damage and even injury.
- Do not change the setting of the protection devices. If the pressure switch, thermal switch, or other protection device is shorted and operated forcibly, or parts other than those specified by Daikin are used, fire or explosion may occur.
- Do not use means to accelerate the defrosting process (if possible) or to clean, other than those recommended by the manufacturer.
- The appliance must be stored in a room without continuously operating ignition sources (for example: open flames, an operating gas appliance or an operating electric heater).
- Do not pierce or burn.
- Be aware that refrigerants may not contain an odor.
- Comply with national gas regulations.

CAUTION

- Do not touch the switch with wet fingers. Touching a switch with wet fingers can cause electric shock.
- Do not allow children to play on or around the unit to prevent injury.
- Wear adequate personal protective equipment (protective gloves, safety glasses,...) when installing, maintaining or servicing the system.
- The heat exchanger fins are sharp enough to cut. To avoid injury, wear gloves or cover the fins while working around them.
- Do not touch the refrigerant pipes during and immediately after operation as the refrigerant pipes may be hot or cold, depending on the condition of the refrigerant flowing through the refrigerant piping, compressor, and other refrigerant cycle parts. Your hands may suffer burns or frostbite if you touch the refrigerant pipes. To avoid injury, give the pipes time to return to normal temperature or, if you must touch them, be sure to wear proper gloves.
- Install drain piping to ensure proper drainage. Improper drain piping may result in water leakage and property damage.
- Insulate piping to prevent condensation.
- Be careful when transporting the product.
- Do not turn off the power immediately after stopping operation. Always wait for at least 5 minutes before turning off the power. Otherwise, water leakage may occur.
- Do not use a charging cylinder. Using a charging cylinder may cause the refrigerant to deteriorate.
- Refrigerant R410A in the system must be kept clean, dry, and tight.
 - (a) Clean and Dry -- Foreign materials (including mineral oils such as SUNISO oil or moisture) should be prevented from getting into the system.

(b) Tight -- R410A does not contain any chlorine, does not destroy the ozone layer, and does not reduce the earth's protection against harmful ultraviolet radiation. R410A can contribute to the greenhouse effect if it is released. Therefore take proper measures to check for the tightness of the refrigerant piping installation. Read the chapter *Refrigerant Piping* and follow the procedures.



- Since R410A is a blend, the required additional refrigerant must be charged in its liquid state. If the refrigerant is charged in a state of gas, its composition can change and the system will not work properly.
- The outdoor unit is for R410A. See the catalog for indoor models that can be connected. Normal operation is not possible when connected to non-compatible indoor units.
- Remote controller (wireless kit) transmitting distance can be shorter than expected in rooms with electronic fluorescent lamps (inverter or rapid start types). Install the indoor unit far away from fluorescent lamps as much as possible.
- Indoor units are for indoor installation only. Outdoor units can be installed either outdoors or indoors.
- Do not install the air conditioner or heat pump in the following locations:
 - (a) Where a mineral oil mist or oil spray or vapor is produced, for example, in a kitchen. Plastic parts may deteriorate and fall off or result in water leakage.
 - (b) Where corrosive gas, such as sulfurous acid gas, is produced. Corroding copper pipes or soldered parts may result in refrigerant leakage.
 - (c) Near machinery emitting electromagnetic waves. Electromagnetic waves may disturb the operation of the control system and cause the unit to malfunction.
 - (d) Where flammable gas may leak, where there is carbon fiber, or ignitable dust suspension in the air, or where volatile flammables such as thinner or gasoline are handled. Operating the unit in such conditions can cause a fire.
- Take adequate measures to prevent the outdoor unit from being used as a shelter by small animals. Small animals making contact with electrical parts can cause malfunctions, smoke, or fire. Instruct the user to keep the area around the unit clean.
- Servicing shall be performed only as recommended by the manufacturer and licensed or certified in their jurisdiction.

NOTE

- The outdoor unit should be positioned where the unit and power supply wires (breaker panel to outdoor unit) are at least 10ft (3m) away from any televisions or radios. (The unit may cause interference with the picture or sound.) Depending on the radio waves, a distance of 10ft (3m) may not be sufficient to eliminate the noise.
- Dismantling the unit, treatment of the refrigerant, oil and additional parts must be done in accordance with the relevant local, state, and national regulations.
- Only use tools for R410A, such as a gauge manifold, charge hose, gas leak detector, reverse flow check valve, refrigerant charge base, vacuum gauge, or refrigerant recovery equipment.
- If the conventional refrigerant and refrigerator oil are mixed in R410A, the refrigerant may deteriorate.
- This air conditioner or heat pump is an appliance that should not be accessible to the general public.
- As maximum allowable pressure is 604psi (4.17MPa), the wall thickness of field-installed pipes should be selected in accordance with the relevant local, state, and national regulations.

RN006-U

Accessories

<p>(A) Installation manual</p>	<p>1</p>	<p>(B) Drain socket*</p>  <p>This is at the bottom of the packaging.</p>	<p>1</p>
<p>(C) Drain cap (1)*</p> 	<p>6</p>	<p>(D) Drain cap (2)*</p> 	<p>3</p>
<p>(E) Warranty</p>	<p>1</p>	<p>(F) General safety consideration</p>	<p>1</p>

* Only for Heat pump models

Precautions for Selecting a Location

- 1) Choose a place solid enough to bear the weight and vibration of the unit, where the operating sound will not be amplified.
- 2) Choose a location where the air discharged from the unit or the operating sound will not cause a nuisance to the neighbors of the user.
- 3) Avoid locations, such as near bedrooms, where the operating sound may cause disturbance.
- 4) There must be sufficient space to carry the unit into and out of the site.
- 5) There must be sufficient space for air passage and no obstructions around the air inlet and the air outlet.
- 6) The site must not be prone to flammable gas leaks in the surrounding area.
- 7) In coastal areas or other places with a salty atmosphere or one containing sulfate gas, corrosion may shorten the life of the air conditioner.
- 8) Since water will flow from the drain of the outdoor unit, do not place anything under the unit which must be kept away from moisture.
- 9) A location where flammable gas does not leak. Position at least 6-5/8ft (2m) from propane gas cylinders.

NOTE

Cannot be installed suspended from a ceiling or stacked.

⚠ CAUTION

When operating the air conditioner in a low outdoor ambient temperature, be sure to follow the instructions described below.

- To prevent exposure to wind, install the outdoor unit with its suction side facing the wall.
- Never install the outdoor unit at a site where the suction side may be exposed directly to wind.
- To prevent exposure to wind, it is recommended to install a baffle plate on the air discharge side of the outdoor unit.
- In heavy snow areas, select an installation site where the snow will not affect the unit.
- If there is a likelihood of snow accumulating on the outdoor unit, attach a snow protection hood.
- In high humidity areas or heavy snow areas, it is recommended to attach a drain pan heater to prevent ice build-up from the bottom frame.

- Construct a large canopy.
- Construct a pedestal.



Install the unit high enough off the ground to prevent burying in snow.

Precautions on Installation

- Check the strength and level of the installation surface so that the unit does not cause any operating vibrations or noise after installation.
- Fix the unit in place securely using foundation bolts, as in the figure. (Prepare 4 sets of 5/16 inch (M8) or 3/8 inch (M10) foundation bolts, nuts and washers; all sold separately.)
- It is best to screw in the foundation bolts until their ends are 3/4 inch (20mm) from the foundation surface.

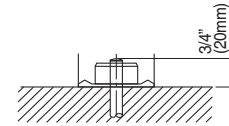

Outdoor Unit Installation Diagram

	RX15/18 RXL15	RXL18	RX24	RX30/36, RK30/36 RXL24
Max. allowable piping length	98-1/2ft (30m)			
Min. allowable piping length	10ft (3m)			
Max. allowable piping height	65-5/8ft (20m)			
Additional refrigerant required for refrigerant pipe exceeding 32-3/4ft (10m) in length.	0.21oz/ft (20g/m)	0.32oz/ft (30g/m)	0.21oz/ft (20g/m)	0.32oz/ft (30g/m)
Gas pipe	O.D. 1/2 inch (12.7mm)		O.D. 5/8 inch (15.9mm)	
Liquid pipe	O.D. 1/4 inch (6.4mm)			

Refrigerant piping must be kept to a minimum.
 *Be sure to add the proper amount of additional refrigerant. Failure to do so may result in reduced performance.
 **The suggested shortest pipe length is 10ft (3m), in order to avoid noise from the outdoor unit and vibration.
 (Mechanical noise and vibration may occur depending on how the unit is installed and the environment in which it is used.)

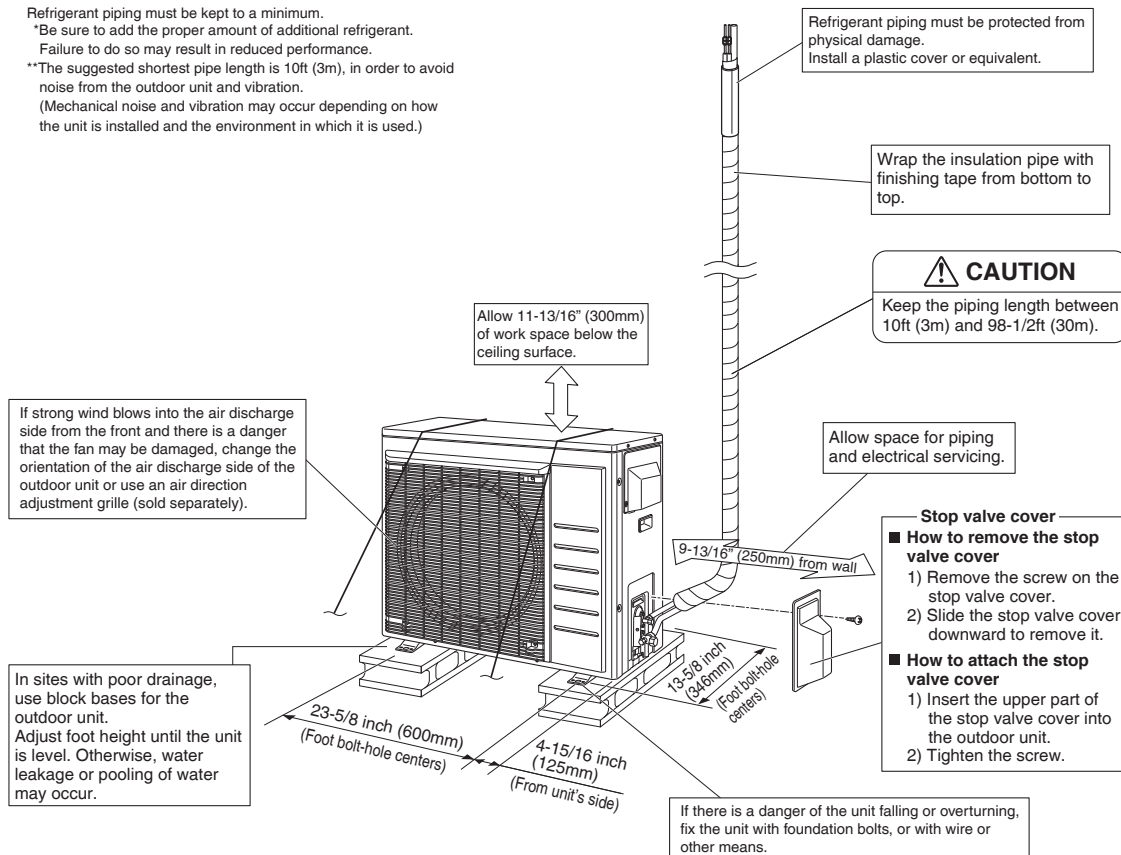

Installation Space Requirements

- Position the unit on a horizontal surface. Any tilt in the unit should be 3° or less to the horizontal.
- Where a wall or other obstacle is in the path of the outdoor unit's intake or exhaust airflow, follow the installation space requirements below.
- For any of the below installation patterns, the wall height on the outlet side should be 47-1/4 inch (1200mm) or less.
- Secure as much installation space around the unit as the location allows, as more space will result in more efficient operation.

Wall facing one side

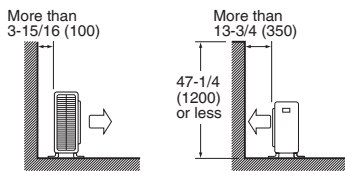

Side view

Walls facing two sides

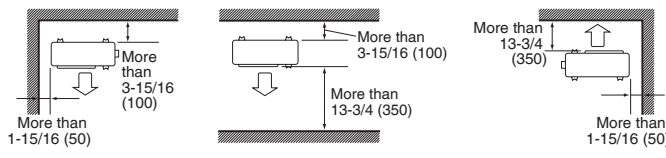

Top view

Walls facing three sides

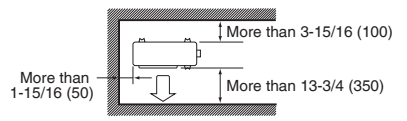

Top view

unit: inch (mm)

When installed as in the figure on the left, it is recommended to either change the orientation of the outdoor unit outlet side or use the air direction adjustment grille (sold separately).

Outdoor Unit Installation

1. Installing the outdoor unit

- When installing the outdoor unit, refer to "Precautions for Selecting a Location" on page 3 and the "Outdoor Unit Installation Diagram" on page 4.
- If drain work is necessary, follow the procedures below.

2. Drain work (Only for heat pump models)

⚠ CAUTION

- In cold areas, do not use a drain socket, drain caps (1,2) and a drain hose with the outdoor unit. (Drain water may freeze, impairing heating performance.)

- If the drain port is covered by a mounting base or floor surface, place additional foot bases of at least 1-1/4 inch (30mm) in height under the outdoor unit's feet.

- 1) Attach ① drain cap (1) and ② drain cap (2).
- 2) Attach ③ drain socket.

- When attaching ③ drain socket to the bottom frame, make sure to connect the drain hose to the drain socket first.

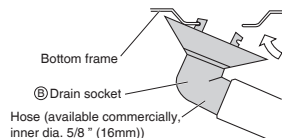
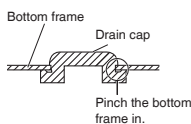
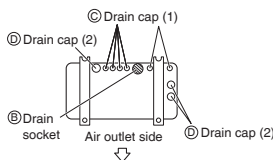

3. Flaring the pipe end

⚠ WARNING

- Do not apply mineral oil to the flare.
- Prevent mineral oil from getting into the system as this would reduce the service life of the units.
- Never use piping which has been used for previous installations. Only use parts which are delivered with this unit.
- Never install a dryer to this R410A unit in order to guarantee its service life.
- The drying material may dissolve and damage the system.
- Incomplete flaring may result in refrigerant gas leakage.

⚠ CAUTION

- Do not reuse joints which have been used once already.

- 1) Cut the pipe end with a pipe cutter.
- 2) Remove burrs with the cut surface facing downward, so that the filings do not enter the pipe.
- 3) Put the flare nut on the pipe.
- 4) Flare the pipe.
- 5) Check that the flaring has been done correctly.

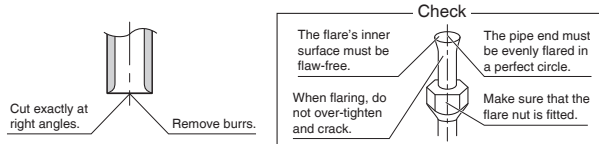

Set exactly at the position shown below.

A	Flare tool for R410A		Conventional flare tool	
	Clutch-type	Clutch-type (Rigid-type)	Wing-nut type (Imperial-type)	
A	0-0.020 inch (0-0.5mm)	0.039-0.059 inch (1.0-1.5mm)	0.059-0.079 inch (1.5-2.0mm)	

4. Refrigerant piping

⚠ CAUTION

- Use the flare nut fixed to the main unit. (This is to prevent the flare nut from cracking as a result of deterioration over time.)
- To prevent gas leakage, apply refrigeration oil only to the inner surface of the flare. (Use refrigeration oil for R410A.)
- Use a torque wrench when tightening the flare nuts to prevent damage to the flare nuts and gas leakage.

- Align the centers of both flares and tighten the flare nuts 3 or 4 turns by hand, then tighten them fully with a spanner and a torque wrench.

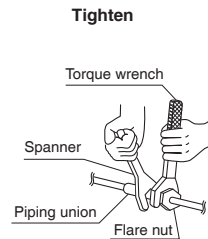
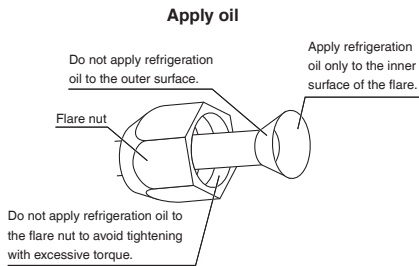

Tightening torque

Piping connection

Flare nut		
Gas side		Liquid side
1/2 inch (12.7mm)	5/8 inch (15.9mm)	1/4 inch (6.4mm)
36-1/2-44-1/2lbf • ft (49.5-60.3N • m)	45-5/8-55-5/8lbf • ft (61.8-75.4N • m)	10-1/2-12-3/4lbf • ft (14.2-17.2N • m)

Valve cap

Width across flats		
11/16 inch (17mm)	1-1/16 inch (27mm)	1-3/16 inch (30mm)
10-1/2-12-5/8lbf • ft (14.2-17.2N • m)	35-3/8-44-1/8lbf • ft (48.0-59.8N • m)	16-5/8-20-1/4lbf • ft (22.5-27.5N • m)

Service port cap

8-10-7/8lbf • ft (10.7-14.7N • m)

Outdoor Unit Installation

Cautions on pipe handling

- Protect the open end of the pipe from dust and moisture.
- All pipe bends should be as gentle as possible. Use a pipe bender for bending.

Selection of copper and heat insulation materials

When using commercial copper pipes and fittings, observe the following:

- Insulation material: Polyethylene foam
Heat transfer rate: 0.041 to 0.052W/mK (0.024 to 0.030Btu/fth°F) (0.035 to 0.045kcal/mh°C)
Be sure to use insulation that is designed for use with HVAC Systems.
- ACR Copper only.
- Be sure to insulate both the gas and liquid piping and observe the insulation dimensions as below.

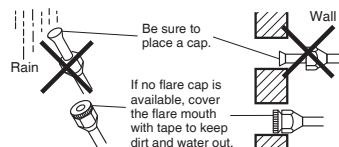

	Piping size	Minimum bend radius	Piping thickness	Thermal insulation size	Thermal insulation thickness
Gas side	O.D. 1/2 inch (12.7mm)	1-9/16 inch (40mm) or more	0.031 inch (0.8mm) (C1220T-O)	I.D. 9/16-5/8 inch (14-16mm)	13/32 inch (10mm) Min.
	O.D. 5/8 inch (15.9mm)	1-15/16 inch (50mm) or more	0.039 inch (1.0mm) (C1220T-O)	I.D. 5/8-13/16 inch (16-20mm)	
Liquid side	O.D. 1/4 inch (6.4mm)	1-3/16 inch (30mm) or more	0.031 inch (0.8mm) (C1220T-O)	I.D. 5/16-13/32 inch (8-10mm)	

- Use separate thermal insulation pipes for gas and liquid refrigerant pipes.
- Using finishing tape, bundle and wrap the indoor unit piping and drain hose together so that the drain hose is below the other piping.

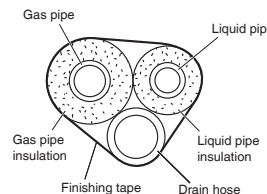

5. Pressure test and evacuating system

⚠ WARNING

- Make sure that air or any matter other than refrigerant (R410A) does not get into the refrigeration cycle.
- If refrigerant gas leaks should occur, ventilate the room as soon and as much as possible.
- R410A, as well as other refrigerants, should always be recovered and never be released directly into the environment.
- Use a vacuum pump for R410A exclusively. Using the same vacuum pump for different refrigerants may damage the vacuum pump or the unit.

⚠ CAUTION

- It is highly recommended that you do not open/close the stop valves when the outdoor temperature is below -5°F (-21°C) as this may result in refrigerant leakage.

- When piping work is complete, it is necessary to perform a pressure test and evacuate system with a vacuum pump.
- If using additional refrigerant, purge the air from the refrigerant pipes and indoor unit using a vacuum pump, then charge additional refrigerant.
- Use a hexagonal wrench (3/16 inch (4mm)) to operate the stop valve rod.
- All refrigerant pipe joints should be tightened with a torque wrench to the specified tightening torque.

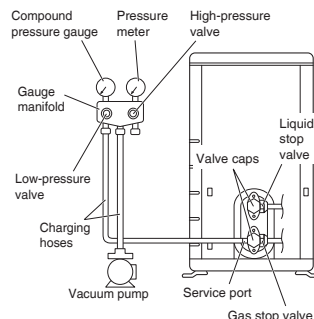

- 1) Pressurize the liquid pipe and gas pipe from the service ports of each stop valve to 604psi (4.17MPa) (do not pressurize more than 604psi (4.17MPa)) for 1 hour minimum, 24 hours recommended. If there is a pressure drop, check for leaks, make repairs and perform the pressure test again.
- 2) Connect the gauge manifold's charging hose to the gas stop valve's service port.
- 3) Fully open the low-pressure valve (Lo) on the gauge manifold and fully close the high-pressure valve (Hi). (High-pressure valve will require no further operation.)
- 4) Evacuate system using vacuum pump to below 500 microns for 1 hour minimum.
- 5) Close the low-pressure valve (Lo) on the gauge manifold and stop vacuum pumping. (Maintain this condition for a few minutes to make sure that the compound pressure gauge pointer does not swing back.)*1
- 6) Remove the valve caps from the liquid stop valve and gas stop valve.
- 7) To open the liquid stop valve, turn the rod of the valve 90° counter-clockwise using a hexagonal wrench. Close it after 5 seconds, and check for gas leakage. Using soapy water, check for gas leakage from the indoor unit's flare and outdoor unit's flare and valve rods. After the check is complete, wipe all soapy water off.
- 8) Disconnect the charging hoses from the service port for the gas stop valve, then fully open the liquid and gas stop valves. (Do not attempt to turn the valve rods further than they can go.)
- 9) Tighten the valve caps and service port caps for the liquid and gas stop valves with a torque wrench to the specified torques. Refer to "4. Refrigerant piping" on page 6 for details.

*1 If the compound pressure gauge pointer swings back, the refrigerant may have water content or there may be a loose pipe joint. Check all pipe joints and retighten nuts as needed, then repeat steps 3) through 5).

6. Refilling refrigerant

Check the type of refrigerant to be used on the machine nameplate.

Precautions when adding R410A

Fill from the liquid pipe in liquid form.

R410A is a mixed refrigerant, so adding it in gas form may cause the refrigerant composition to change, preventing normal operation.

- Before filling, check whether the cylinder has a siphon attached or not. (It should have something like "liquid filling siphon attached" displayed on it.)

Filling a cylinder with an attached siphon



Stand the cylinder upright when filling.

(There is a siphon pipe inside, so the cylinder need not be upside-down to fill with liquid.)

Filling other cylinders



Turn the cylinder upside-down when filling.

- Be sure to use the R410A tools to ensure pressure and to prevent foreign objects from entering.

Wiring

⚠ WARNING

- Do not ground units to water pipes, gas pipes, telephone wires, or lightning rods as incomplete grounding can cause a severe shock hazard resulting in severe injury or death. Additionally, grounding to gas pipes could cause a gas leak and potential explosion causing severe injury or death.
- Do not use tapped wires, extension cords, or starburst connections, as they may cause overheating, electric shock, or fire.
- Do not use locally purchased electrical parts inside the product. (Do not branch the power for the drain pump, etc., from the terminal block.) Doing so may cause electric shock or fire.
- The circuit must be protected with safety devices in accordance with local and national codes, i.e. a circuit breaker.
- Use an all-pole disconnection type circuit breaker with at least 1/8 inch (3mm) between the contact point gaps.
- When carrying out wiring, take care not to pull at the conduit.
- Do not connect the power wire to the indoor unit. Doing so may cause electric shock or fire.
- Do not turn on the circuit breaker until all work is completed.

⚠ CAUTION

Precautions to be taken for power supply wiring

Recommend stranded cable for interunit wiring. Local code always supersedes recommendation.

- For stranded wires, make sure to use the round crimp-style terminal for connection to the power supply terminal block. Place the round crimp-style terminals on the wires up to the covered part and secure in place.

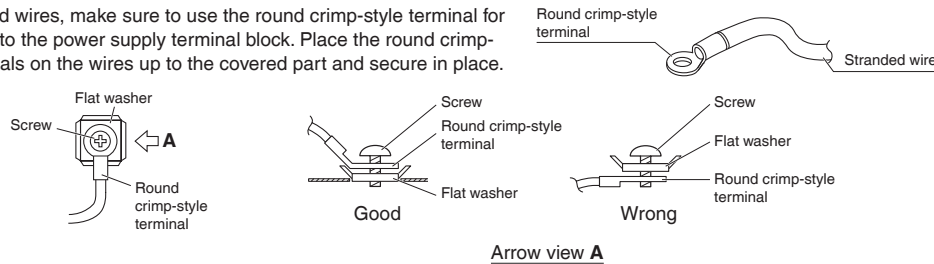

- If solid core wire must be used, be sure to curl the end of the lead. Improper work may cause heat and fire.

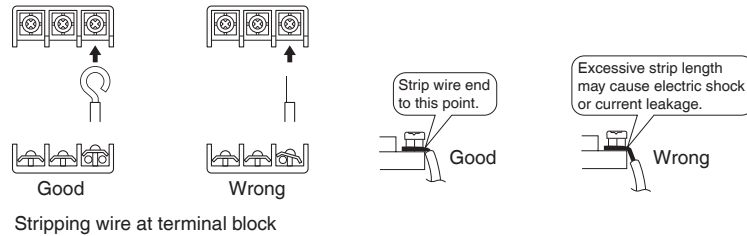

- 1) Strip the insulation from the wire (3/4 inch (20mm)).
- 2) Connect the inter-unit wires between the indoor and outdoor units so that the terminal numbers match. Tighten the terminal screws securely. It is recommended that a slot-head screwdriver be used to tighten the screws.

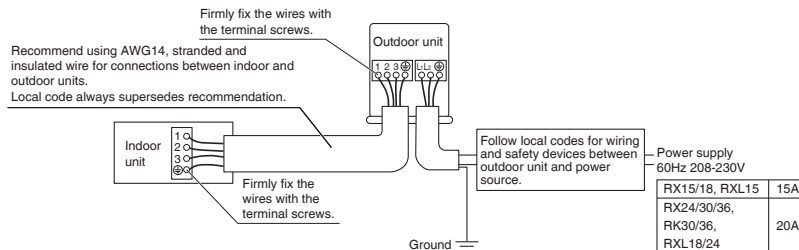

NOTE

Take care to ensure that all wiring between indoor unit and outdoor unit has a consistent connection. Any splices can cause communication errors.

[Method of mounting conduit]

- 1) Dismount the service lid by removing the 2 screws.
- 2) Pass wires through the conduit and secure them with a lock nut.
- 3) After completing the work, reattach the service lid to its original position.

RX15/18/24, RXL15 models

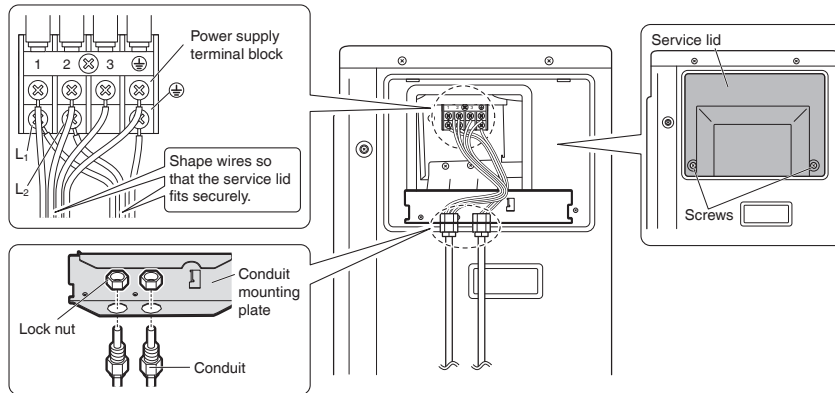

RX30/36, RK30/36, RXL18/24 models

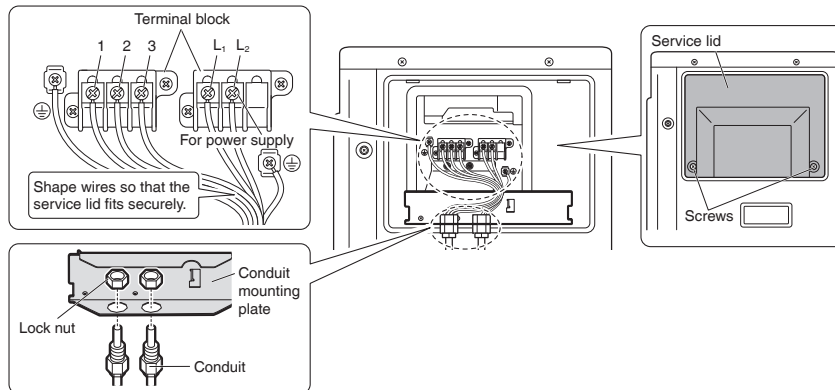

Ground

This air conditioner must be grounded. For grounding, follow all local, and state electrical codes.

Facility Setting (cooling at low outdoor temperature)

⚠ WARNING

- Make sure to turn the power OFF before performing work.

⚠ CAUTION

- If the outdoor unit is installed where the heat exchanger of the unit is exposed to direct wind, provide a windbreak wall.
- Intermittent noises may be produced by the indoor unit due to the outdoor fan turning on and off when using facility settings.
- Do not place humidifiers or other items which might raise the humidity in rooms where facility settings are being used. A humidifier might cause dew condensation from the indoor unit outlet vent.
- Activating the facility setting sets the indoor fan tap to the highest position. Notify the user about this.

This function is designed for facilities such as equipment or computer rooms. It is never to be used in a residence or office where people occupy the space.

RX15/18/24, RXL15 models

■ Cutting jumper 6 (J6) on the PCB will extend the operation range to 14°F (-10°C). Installing an air direction adjustment grille (sold separately) will further extend the operation range to -4°F (-20°C). In these cases, the unit will stop operating if the outdoor temperature falls below -4°F (-20°C), restarting once the temperature rises above this level.

- 1) Remove the top plate of the outdoor unit. (6 screws)
- 2) Remove the front plate. (8 screws)
- 3) Remove the anti-drip cover.
- 4) Cut the jumper (J6) of the PCB inside.

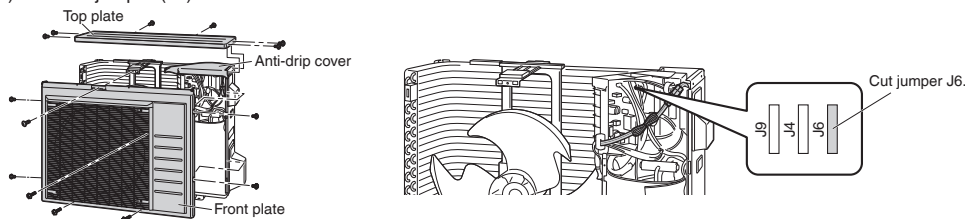

RX30/36, RK30/36, RXL18/24 models

■ Turning on SW5-3 on the PCB will extend the operation range to 14°F (-10°C). Installing an air direction adjustment grille (sold separately) will further extend the operation range to -4°F (-20°C). In these cases, the unit will stop operating if the outdoor temperature falls below -4°F (-20°C), restarting once the temperature rises above this level.

- 1) Remove the service lid. (2 screws)
- 2) Remove the switch cover. (1 screw)
- 3) Turn on SW5-3.

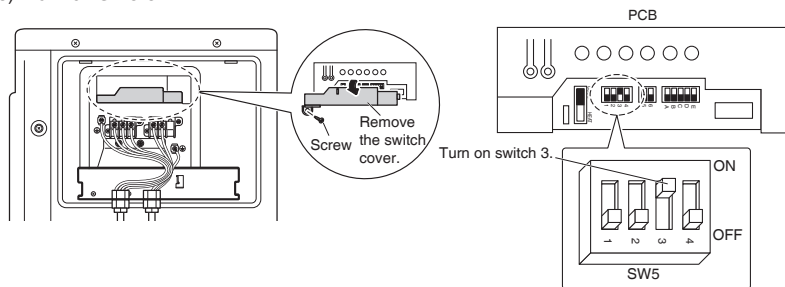

Only for cooling models

■ In addition to turning on SW5-3, turning on SW6-2 as well on the PCB will extend the operation range to -22°F (-30°C). The unit will stop operating if the outdoor temperature falls below -22°F (-30°C), restarting once the temperature rises above this level.

- 1) Turn on SW6-2 in addition to SW5-3.

NOTE

When the outdoor temperature is below -4°F (-20°C) and if SW6-2 in this step is turned on, for the purpose of protecting the compressor, it may take up to 3 hours for operation to begin while the system warms up.

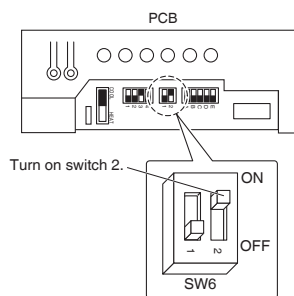

When attaching the drain pan heater

⚠ WARNING

- Make sure to turn the power OFF before performing work.

In high humidity areas or heavy snow areas, it is recommended to attach a drain pan heater to prevent ice build-up from the bottom frame.

RX15/18/24, RXL15 models

- 1) Attach the drain pan heater in accordance with the installation manual included with the drain pan heater.
- 2) Cut the jumper (J9) of the PCB inside.

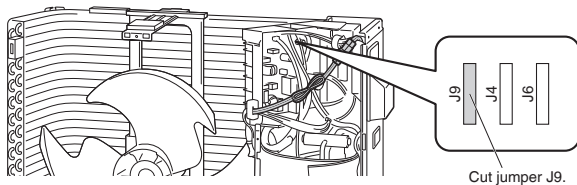

RX30/36, RK30/36, RXL18/24 models

- 1) Attach the drain pan heater in accordance with the installation manual included with the drain pan heater.
- 2) Turn on SW6-1 on the PCB.

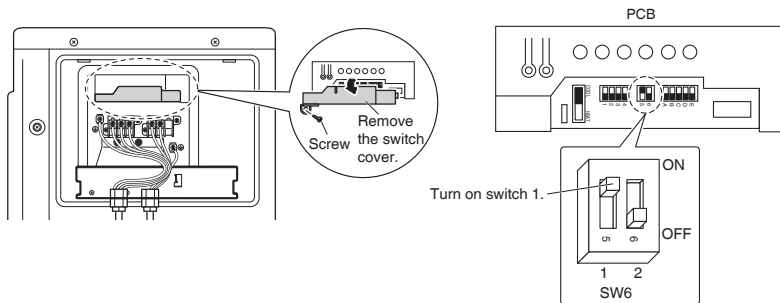

Pump Down Operation

In order to protect the environment, be sure to pump down when relocating or disposing of the unit.

- 1) Remove the valve caps from the liquid stop valve and gas stop valve.
- 2) Begin forced cooling operation.
- 3) After 5 to 10 minutes, close the liquid stop valve with a hexagonal wrench.
- 4) After 2 to 3 minutes, close the gas stop valve and stop forced cooling operation.
- 5) Attach the valve caps once procedures are complete.

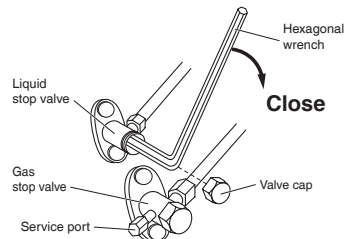

Forced cooling operation

■Using the indoor unit ON/OFF switch [For FTX, FTXR and FVX models]

Press the indoor unit ON/OFF switch for at least 5 seconds.
(The operation will start.)

- Forced cooling operation will stop automatically after about 15 minutes.
To stop the operation, press the indoor unit ON/OFF switch.

■Using the indoor unit's remote controller [For FFQ and FDMQ models]

[For wired remote controller]







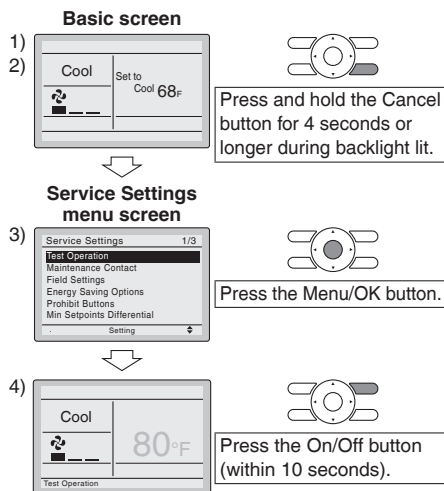

- 1) Set to COOL operation using the remote controller.
- 2) Press and hold the Cancel button for 4 seconds or longer.
Service settings menu is displayed.
- 3) Select **Test Operation** in the service settings menu, and press the Menu/OK button. Basic screen returns and "Test Operation" is displayed at the bottom.
- 4) Press the On/Off button within 10 seconds, and the forced cooling operation starts.
 - Forced cooling operation will stop automatically after about 15 minutes. To stop the operation, press the On/Off button.

[For wireless remote controller]







- 1) Press and select the COOL operation.
- 2) Press twice. "Test" is displayed.
- 3) Press within 10 seconds, and the forced cooling operation starts.
- Forced cooling operation will stop automatically after about 15 minutes.
To stop the operation, press .



[For FTX18/24/30/36, FTXR, FVXS models]

- 1) Press ,  and  at the same time.
 - 2) Press , select “ 7 ”, and press  for confirmation.
 - 3) Press  and select the COOL operation.
 - 4) Press  to turn on the system.
- Forced cooling operation will stop automatically after about 30 minutes. To stop the operation, press .

[For FTX15 models]

- 1) Press ,  and  at the same time.
 - 2) Press , then select 7, press .
 - 3) Press  to turn on the system.
- Forced cooling operation will stop automatically after about 30 minutes. To stop the operation, press .

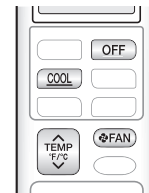

Trial Operation and Testing

- When trial operation is conducted directly after the circuit breaker is turned on, in some cases no air will be output for about 15 minutes in order to protect the air conditioner.

1. Trial operation and testing

Refer to the installation manual for the indoor unit.

2. Test items

Test items	Symptom	Check
Indoor and outdoor units are installed securely.	Fall, vibration, noise	
No refrigerant gas leaks.	Incomplete cooling/heating function	
Refrigerant gas and liquid pipes and indoor drain hose extension are thermally insulated.	Water leakage	
Draining line is properly installed.	Water leakage	
System is properly grounded.	Electrical leakage	
Only specified wires are used for all wiring, and all wires are connected correctly.	No operation or burn damage	
Indoor or outdoor unit's air inlet or air outlet are unobstructed.	Incomplete cooling/heating function	
Stop valves are opened.	Incomplete cooling/heating function	
[For FFQ models] Check that the connector of the lead wires of the decoration panel is connected securely.	Louvers do not move	
Indoor unit properly receives remote control commands.	No operation	

12.6 <BYFQ60B3W1> Decoration Panel

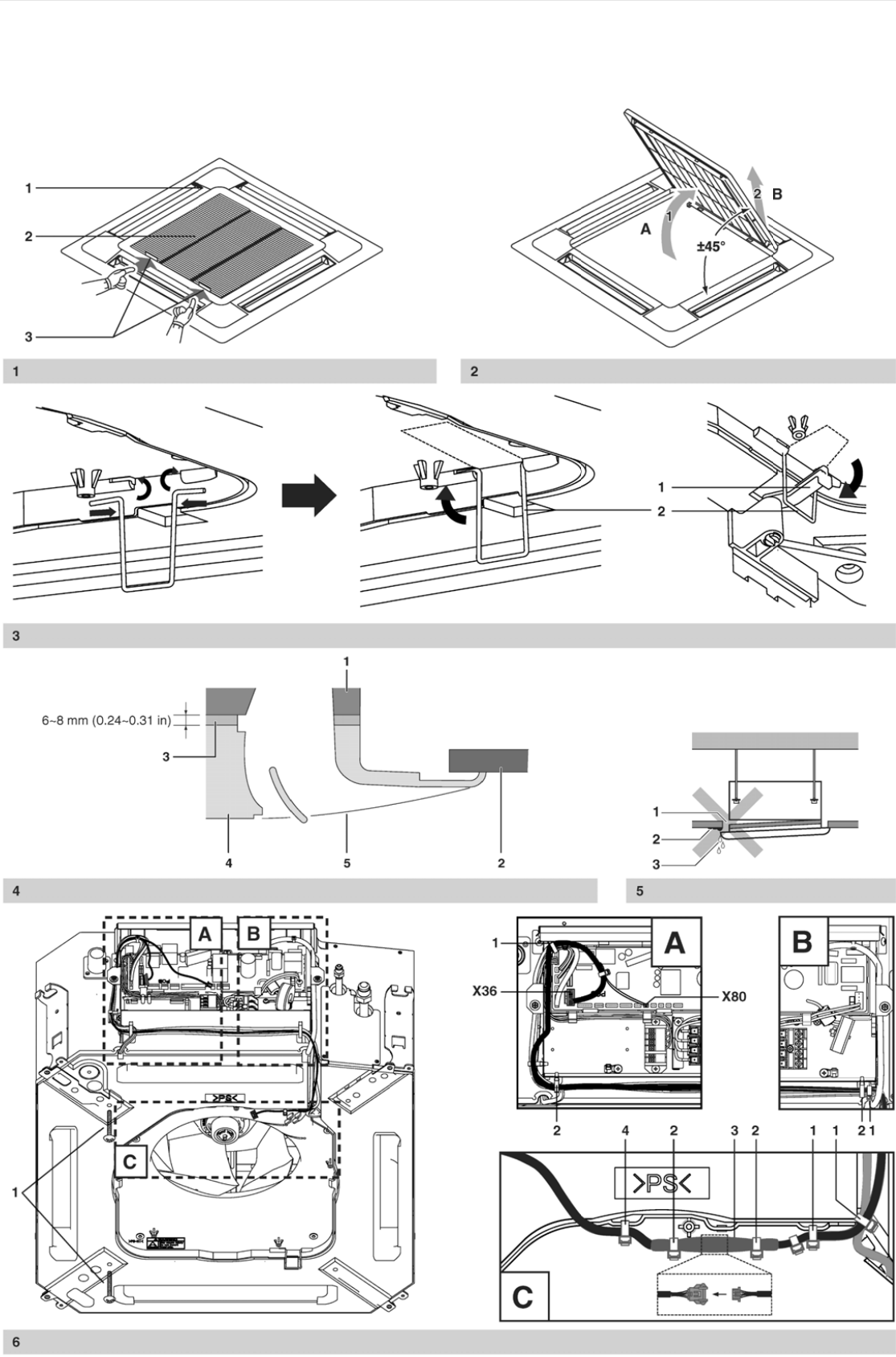

! The English text is the original instruction. Other languages are translations of the original instructions.

Read this manual attentively before installation. Do not throw it away. Keep it in your files for future reference.

Improper installation or attachment of equipment or accessories could result in electric shock, short-circuit, leaks, fire or other damage to the equipment. Be sure only to use accessories made by Daikin that are specifically designed for the use with the equipment and have them installed by a professional.

If unsure of installation procedures or use, always contact your dealer for advice and information.

Before installation

- Leave the unit inside its packaging until you reach the installation site.

! **Rotary fan**



Cut off the main power before opening the grille.







- Refer to the installation manual of the indoor unit for items not described in this manual.

NOTE **To the installer**



Be sure to instruct the customer how to properly operate the system showing him or her the operation manual of the indoor unit.

Accessories

Installation manual		Wire harness	
Screws (4x)		Temporary latch	
Fibre glass tube		Tie wrap (7x)	

Preparation before installation

For this unit, you are able to select air flow directions. To discharge air in 2 or 3 directions, it is necessary to purchase the optional blocking pad kit for sealing air discharge outlets.

Handling of the decoration panel

To prevent any damage to the decoration panel, take care of the following:

- Never place the decoration panel facing down.
- Never let the decoration panel lean against a wall.
- Never place the decoration panel on a sharp or projecting object.
- Never touch or put pressure on the swing flap in order to prevent malfunction of the swing flap.

Preparing the decoration panel for installation

- 1 Remove the suction grille from the decoration panel.
 - 1 Decoration panel
 - 2 Suction grille
 - 3 Lever
 - Push the suction grille lever (3) inward and open the suction grille (2). (See figure 1)
 - Detach the suction grille from the decoration panel by lifting the suction grille up approximately 45 degrees (A) until the position is reached on which removal of the suction grille is possible (B). (See figure 2)

Installation of the decoration panel to the indoor unit

Refer to the installation manual of the indoor unit for details on installing the indoor unit.

Installation and wiring of the decoration panel.

! Make sure to turn off the power supply before wiring!

For installation and wiring of the decoration panel see figure 6.

- 1 Screws
- A**
- 1 Tie wrap
 - 2 Latch
- Socket X36
Socket X80
- B**
- 1 Tie wrap
 - 2 Latch
- C**
- 1 Tie wrap
 - 2 Tie wrap
 - 3 Fibre glass tube
 - 4 Tie wrap

- 1 Attach wire harness from panel accessory set to unit and to other wire harness by two tie wraps (1). (See figure 6-C)
- 2 Lead the wire harness through unit's groove and attach it by tie wrap (1) to the rest of wire harnesses. (See figure 6-B)
- 3 Open two latches (2) and insert the wire harness so it is in the same condition as other wire harnesses. (See figure 6-A and 6-B)
- 4 Insert wire harness into switch box using lower hole, insert two connectors into proper sockets (X36, X80) and secure the wire harness by tie wrap (1). (See figure 6-A)
- 5 Provisionally tighten the 2 supplied screws (1) approximately 5 mm (0.2 in) into the indoor unit as marked in figure. (See figure 6)

- 6 Attach latch (2) from panel accessory set to unit according to figure 3. Then turn this latch up. (See figure 3)
- 7 Slide the panel over the provisionally tightened screws matching the 2 attachment holes (□).
- 8 Turn decoration panel lever (1) 90 degrees and then turn temporary latch (2) down to secure panel in temporary position. (See figure 3)
- 9 Attach remaining screws and tighten all 4 screws until the thickness of the sealing material between the decoration panel and the indoor unit reduces to 6-8 mm. (See figure 4)

- 1 Indoor unit
- 2 Ceiling
- 3 Sealing material
- 4 Decoration panel
- 5 Air outlet

- 10 Pull the fibre glass tube (3) over decoration panel wire harness. Then connect both wire harnesses together and move the fibre glass tube over this connection. Secure the fiber glass tube by two tie wraps (2) according to figure 6-C. Then attach decoration panel wire harness to unit by tie wrap (4). (See figure 6-C)



Make sure that the swing flap motor lead wire is not caught between the indoor unit and the decoration panel and inbetween the electric component box lid.

Precautions

- Improper tightening of the screws - (See figure 5) - may cause air to leak into the unit and between the ceiling and the decoration panel (1), resulting in formation of contamination (2) and dew (3).
- If there is a gap remaining between the ceiling and the decoration panel after tightening the screws, re-adjust the indoor unit body height. The indoor unit must be kept leveled and the drain piping kept unaffected.

Installation of the suction grille

Install the suction grille by reversing the procedure shown in "Preparing the decoration panel for installation" on page 1.

- The suction grille may be installed in 4 directions by simply turning it 90 degrees.
- Change the direction when adjusting the direction of the suction grille of multiple units or to comply with the demands of the customer.

NOTE



Be careful not to get the swing flap motor lead wire get caught when installing the suction grille.

12.7 <BYFQ60C2W1W(S)> Decoration Panel

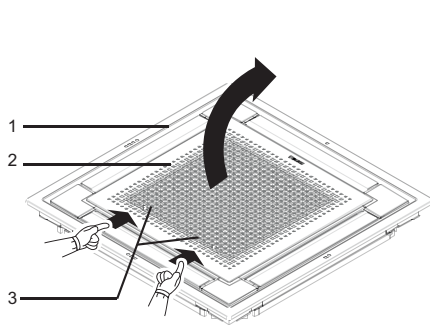

1

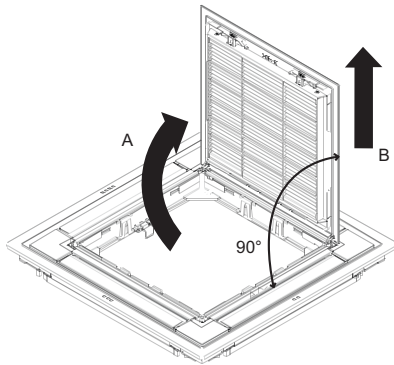

2

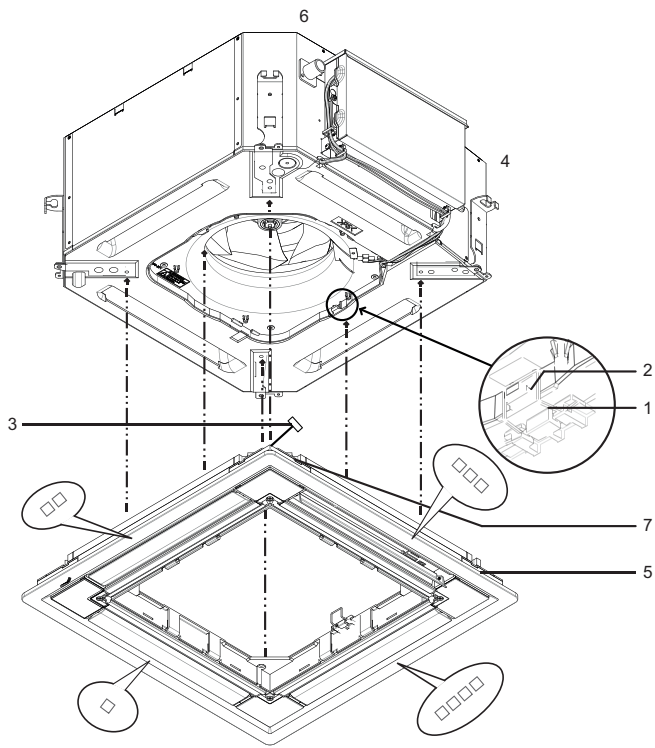

3

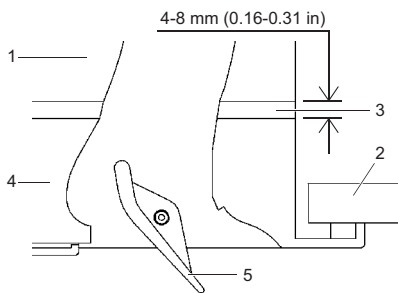

4

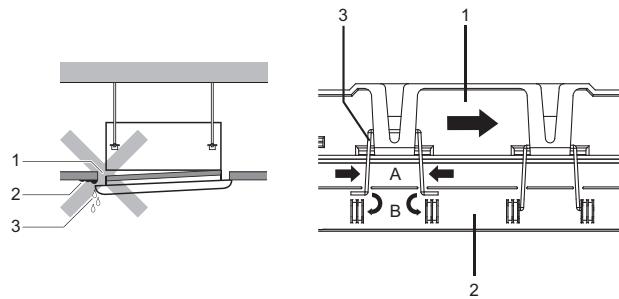

5

7

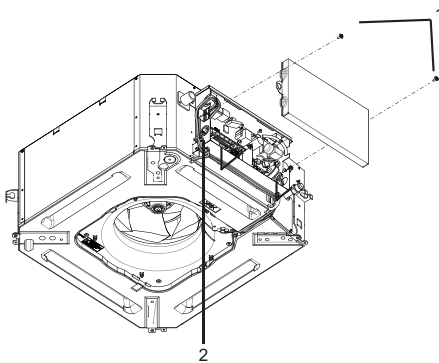

6

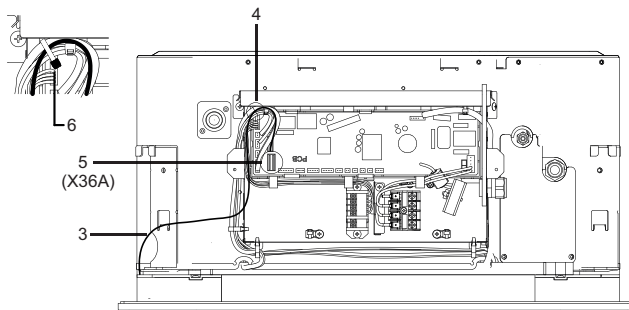

! The English text is the original instruction. Other languages are translations of the original instructions.

Read this manual attentively before installation. Do not throw it away. Keep it in your files for future reference.

Improper installation or attachment of equipment or accessories could result in electric shock, short-circuit, leaks, fire or other damage to the equipment. Be sure only to use accessories made by Daikin that are specifically designed for the use with the equipment and have them installed by a professional.

If unsure of installation procedures or use, always contact your dealer for advice and information.

Before installation

- Leave the unit inside its packaging until you reach the installation site.

! **Rotary fan**





Cut off the main power before opening the grille.

- Refer to the installation manual of the indoor unit for items not described in this manual.

NOTE **To the installer**

 Be sure to instruct the customer how to properly operate the system showing him or her the operation manual of the indoor unit.

Accessories

Installation manual	
Screws (4x)	
Grille hinge (2x)	

Preparation before installation

For this unit, you are able to select air flow directions. To discharge air in 2 or 3 directions, it is necessary to purchase the optional blocking pad kit for sealing air discharge outlets.

Handling of the decoration panel

To prevent any damage to the decoration panel, take care of the following:

- Never place the decoration panel facing down.
- Never let the decoration panel lean against a wall.
- Never place the decoration panel on a sharp or projecting object.
- Never touch or put pressure on the swing flap in order to prevent malfunction of the swing flap.

Preparing the decoration panel for installation

- 1 Remove the suction grille from the decoration panel.
 - 1 Decoration panel
 - 2 Suction grille
 - 3 Lever
 - Remove the transporting tape from the decoration panel suction grille and flaps.
 - Push the suction grille lever (3) inward and open the suction grille (2). (See figure 1)
 - Detach the suction grille from the decoration panel by lifting the suction grille up approximately 90 degrees (A) until the position is reached on which removal of the suction grille is possible (B). (See figure 2)

Installation of the decoration panel to the indoor unit

Refer to the installation manual of the indoor unit for details on installing the indoor unit.

- 1 Install the decoration panel (See figure 3)
 - 1 Temporary latch
 - 2 Hook
 - 3 Swing flap motor lead wire
 - 4 Piping area
 - 5 Piping side mark
 - 6 Drain area
 - 7 Drain side mark
 - 1 Hold the decoration panel against the indoor unit by matching the piping side and drain side marks on the decoration panel with the position of the piping area and drain area of the indoor unit.
 - 2 Turn 2 panel temporary latches up into the hooks of the indoor unit so the decoration panel is temporarily fixed to the indoor unit. (See figure 3)
 - 3 Make sure that the swing flap motor lead wire isn't caught between the decoration panel and the indoor unit.
 - 4 Attach 4 supplied screws and check whether the decoration panel is properly aligned with the indoor unit and ceiling.
 - 5 Tighten all 4 screws until the thickness between of the sealing material between the decoration panel and the indoor unit reduces to 4-8 mm. (See figure 4)

- 1 Indoor unit
- 2 Ceiling
- 3 Sealing material
- 4 Decoration panel
- 5 Air outlet

Precautions

- Improper tightening of the screws - (See figure 5) - may cause air to leak into the unit and between the ceiling and the decoration panel (1), resulting in formation of contamination (2) and dew (3).
- If there is a gap remaining between the ceiling and the decoration panel after tightening the screws, re-adjust the indoor unit body height. The indoor unit must be kept leveled and the drain piping kept unaffected.

2 Wiring of the decoration panel (See figure 6)



Make sure to turn off the power supply before wiring!

- 1 Screws (2)
- 2 Switch box
- 3 Swing flap motor lead wire
- 4 Swing flap motor lead wire fixed by tie wrap to the rest of the wires (See detail in figure 6)
- 5 Connector of the indoor unit PCB (X36A)
- 6 Tie wrap

- 1 Remove the electric components box lid. Loosen 2 screws and slide the electric components box lid in the direction of the arrows.
- 2 Securely connect the connector of swing flap motor lead wire installed on the decoration panel. Attach the swing flap motor lead wire to the rest of the wires firmly by tie wrap (from indoor unit accessory set). (See figure 6)
- 3 Replace the electric components box lid reversing the procedure to remove it.



Make sure that the swing flap motor lead wire is not caught between the indoor unit and the decoration panel and inbetween the electric component box lid.

Installation of the suction grille to decoration panel

Install the suction grille (See figure 7)

- 1 Decoration panel
- 2 Suction grille
- 3 Suction grille hinge (attached to decoration panel)

- 1 Remove the transportation tape which is securing 2 suction grille hinges in place.
- 2 Attach the suction grille to hinges by pressing the hinge and inserting both ends of hinge to holes on the suction grille. (See figure 7)
- 3 Make sure that the suction grille is attached to the decoration panel properly by 2 hinges.
- 4 Close the suction grille by reversing the procedure shown in "Preparing the decoration panel for installation" on page 1.
 - The suction grille may be installed in 4 directions by simply turning it 90 degrees.
 - Change the direction when adjusting the direction of the suction grille of multiple units or to comply with the demands of the customer.

12.8 <BRC1E73> Wired Remote Controller

1. Safety Considerations

The original instructions are written in English. All other languages are translations of the original instructions.

All phases of the field-installation, including, but not limited to, electrical, piping, safety, etc. must be in accordance with manufacturer's instructions and must comply with national, state, provincial and local codes.



Read these **SAFETY CONSIDERATIONS** carefully before installing the remote controller.

After completing the installation, ensure that the remote controller operates properly during the startup operation.

Train the customer to operate and maintain the remote controller. Inform customers that they should store this Installation Manual with the Operation Manual for future reference.

Always use a licensed installer or contractor to install this product. Improper installation can result in electrical shock, fire, or explosion.

Meanings of **WARNING**, **CAUTION**, and **NOTE** Symbols.

 WARNING	Indicates a potentially hazardous situation which, if not avoided, could result in death or serious injury.
 CAUTION	Indicates a potentially hazardous situation which, if not avoided, may result in minor or moderate injury. It may also be used to alert against unsafe practices.
 NOTE	Indicates situations that may result in equipment or property-damage accidents only.

 WARNING
Only qualified personnel must carry out the installation work.
Consult your Daikin dealer regarding relocation and reinstallation of the remote controller. Improper installation work may result in electric shocks or fire.
Electrical work must be performed in accordance with relevant local and national regulations and with instructions in this installation manual. Improper installation may cause electrical shocks or fire.
Use only specified accessories and parts for installation work. Failure to use specified parts may result in electric shocks, fire, or the unit falling.
Do not disassemble, reconstruct, or repair. Electric shock or fire may occur.
Make sure that all wiring is secured, that specified wires are used, and that no external forces act on the terminal connections or wires. Improper connections or installation may result in fire.
Before touching electrical parts, confirm the power-off to the unit.

⚠ CAUTION

Keep water out of the remote controller.

To avoid electric shock due to entry of water or insects, fill the wiring through-hole with putty.

Do not wash the remote controller with water as it may result in electrical shocks or fire.

Do not touch the remote controller buttons with wet fingers.

Touching the buttons with wet fingers can cause an electric shock.

Do not install the remote controller in the following locations:

- (a) Where a mineral oil mist or oil spray or vapor is produced, for example, in a kitchen.
Plastic parts may deteriorate.
- (b) Where corrosive gas, such as sulfurous acid gas, is produced.
- (c) Near machinery emitting electromagnetic waves.
Electromagnetic waves may disturb the operation of the control system and cause the unit to malfunction.
- (d) Where flammable gas may leak, where there is carbon fiber or ignitable dust suspensions in the air, or where volatile flammables such as thinner or gasoline are handled.
Operating the unit in such conditions can cause a fire.
- (e) High temperature area or direct flame.
Overheating and/or fire can occur.
- (f) Moist area, where there is exposure to water. If water enters the inside of the remote controller, it may cause electric shock and electrical components may fail.

⚠ NOTE







Install the control wires for the indoor and the remote controller at least 3.5 feet (1 meter) away from televisions or radios to prevent image interference or noise. Depending on the radio waves, a distance of 3.5 feet (1 meter) may not be sufficient to eliminate the noise.

When remote controller's temperature sensor is used, select the installation location as per the following:

- A place where average temperature in the room can be detected.
- A place where it is not exposed to direct sunlight.
- A place where it is far away from any heat source.
- A place where it is not affected directly by outside air.

2. Accessories

The following accessories are included.

Drywall screw	Drywall anchor	Wire tie	Operation manual	Installation manual	Wiring retainer
					
(2 pcs.)	(2 pcs.)	(1 pc.)	(1 pc.)	(1 pc.)	(1 pc.)

3. Remote Controller Installation Procedure

3-1 Determine where to install the remote controller.

Make sure to follow the **Safety Considerations** when determining the location.

3-2 If the control wire for the remote controller is to be routed from the rear, consider the location of the access hole in the lower case for making a hole in the wall.

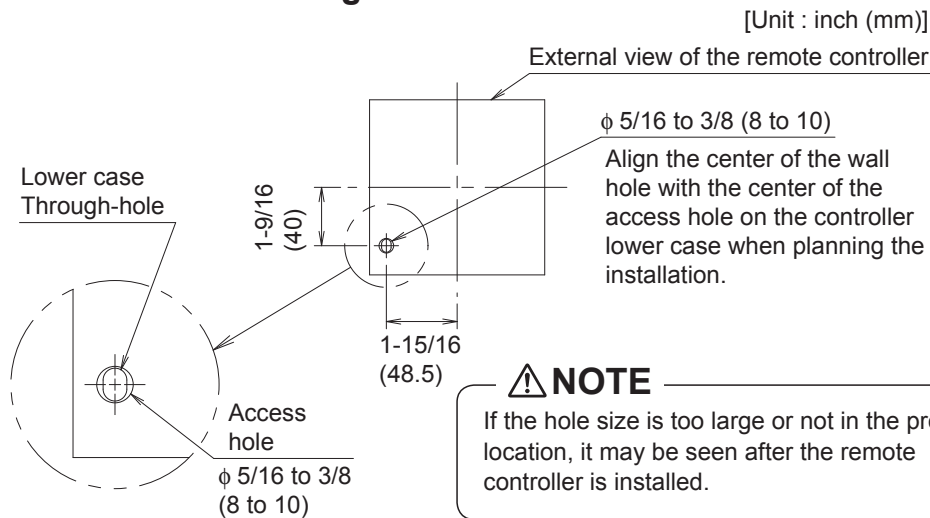

3-3 Remove upper case.

Insert a screwdriver in the recess of lower case to remove the upper case (2 points).

Remote controller printed-circuit board is installed on the upper case. Be careful not to damage the printed-circuit board with the screwdriver.

Be careful not to let dust or moisture touch the printed-circuit board.

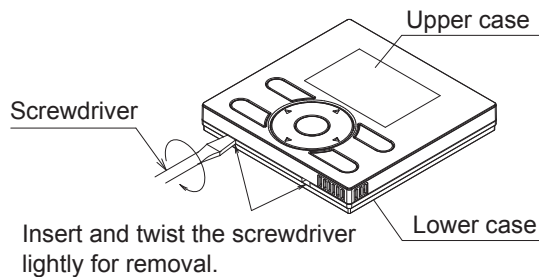

3-4 Determine the location where the wiring will enter the remote controller (back, left side, top left, top center).

3-4-1 Back outlet

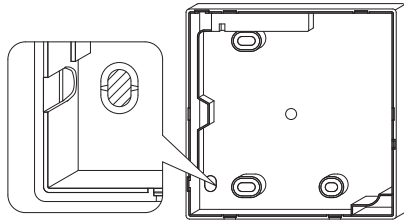

Cut off resin area (notched area).

3-4-2 Left outlet

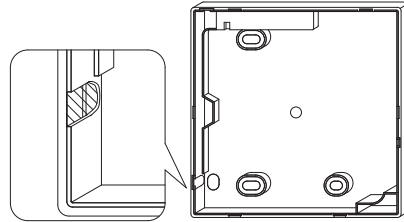

Cut the plastic at the notched area and remove any remaining burrs.

3-4-3 Top left outlet

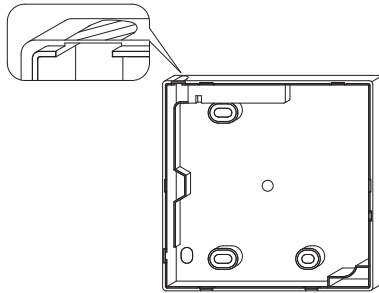

Cut the plastic at the notched area and remove any remaining burrs.

3-4-4 Top center outlet

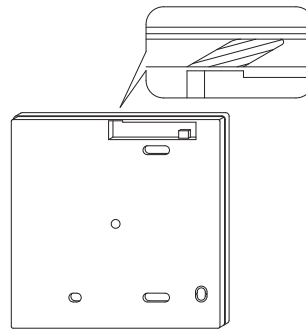

Cut the plastic at the notched area and remove any remaining burrs.

3-5 Install wiring.

⚠ NOTE

1. Switch box and control wiring are field supplied.
2. Do not touch the remote controller printed-circuit board.

Wiring Specifications

Wiring Type	Non-shielded, 2-conductor, stranded copper wire
Wiring Size	AWG-18
Wiring Length	Maximum 1640 feet (500 m)

Prepare the wiring for connection to the remote controller following these instructions:

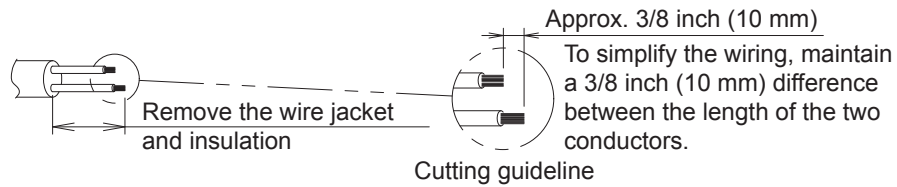

Length of jacket to be removed:

- Approx. 6 inch (150 mm) for top left outlet
- Approx. 8 inch (200 mm) for top center outlet

Connect the terminals (P/P1, N/P2) of the remote controller to the terminals (P1, P2) of the indoor unit. (P1 and P2 are not polarity sensitive.)

3-5-1 Back outlet

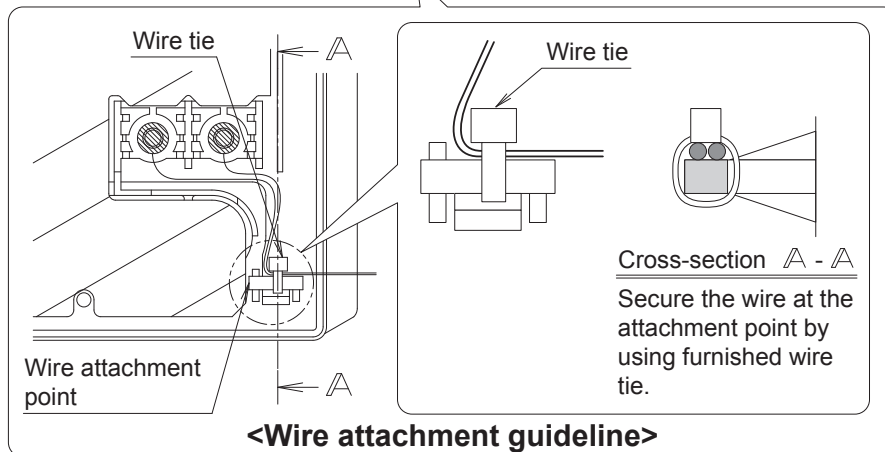
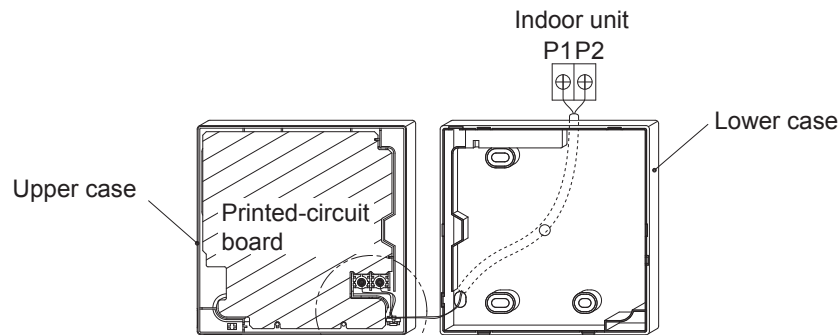

3-5-2 Left outlet

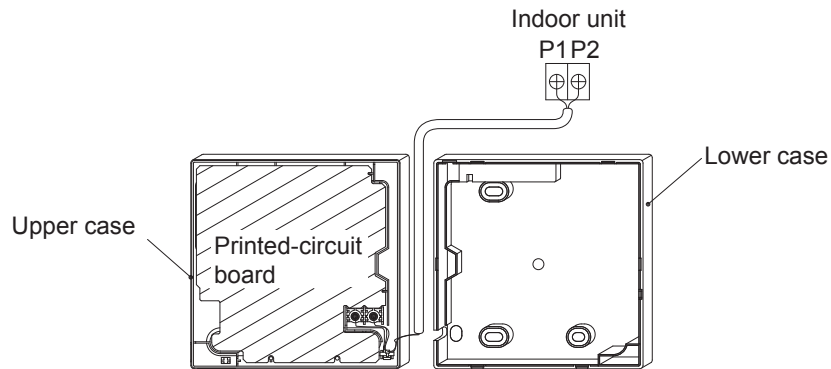

3-5-3 Top left outlet

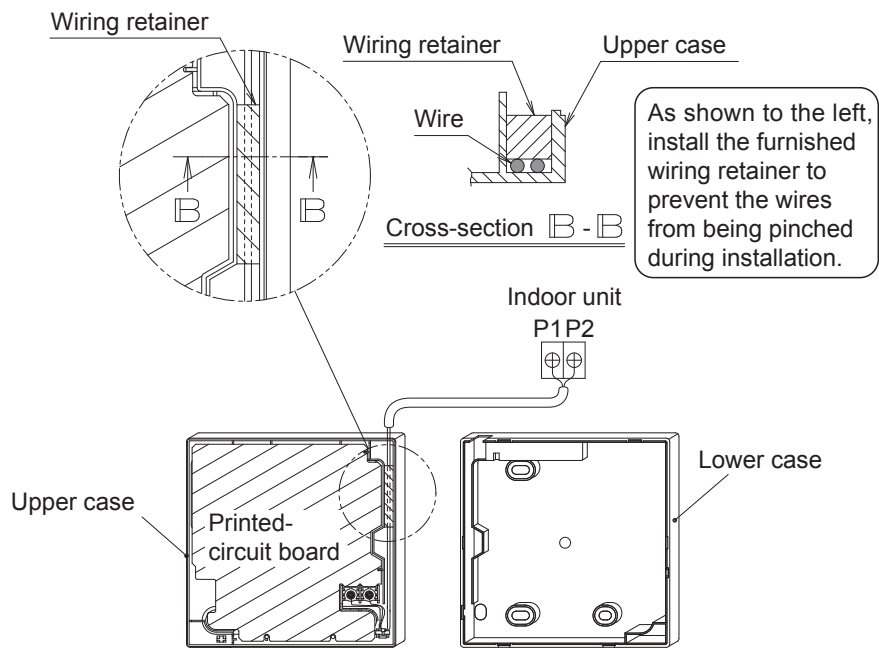

3-5-4 Top center outlet

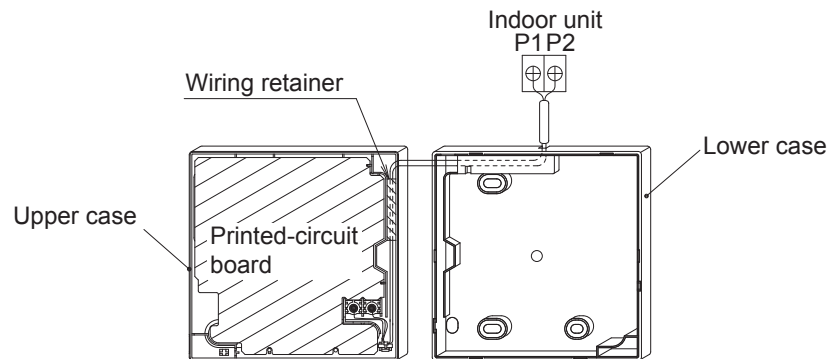

NOTE

- To prevent electrical noise and possible communication errors, avoid installing the remote controller wiring parallel to or in the vicinity of line voltage circuits.

3-6 Installation procedure for the lower case.

When wiring the remote controller through the top center or rear access points, attachment of the wire to the lower case is required before it is wall mounted. Closely follow the wiring procedures.

3-6-1 Wall installation

Secure by using furnished drywall anchors and screws (2 pcs.).

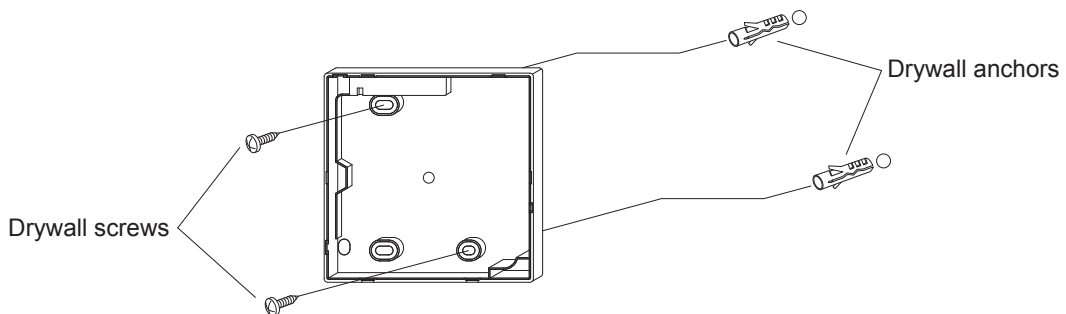

3-6-2 Switch box installation

Secure by using field supplied machine screws (2 pcs.).

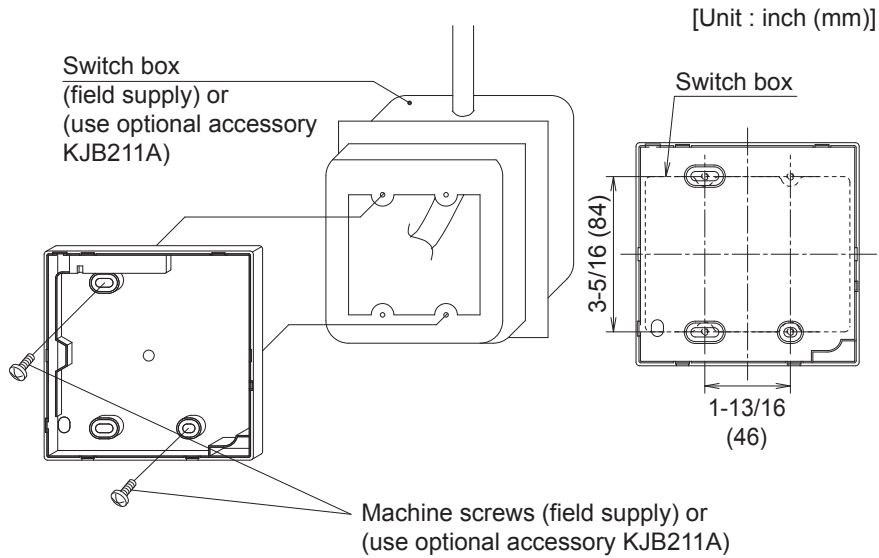

NOTE

- Install the control on a flat surface only.
- To prevent deformation of the lower case, avoid over-tightening the installation screws.

3-7 Install the upper case.

- Align the upper case with tabs of the lower case (6 points), insert and install the upper case.
- Install the wiring with care to prevent pinching.
- Peel off the protective membrane which overlays the upper case.

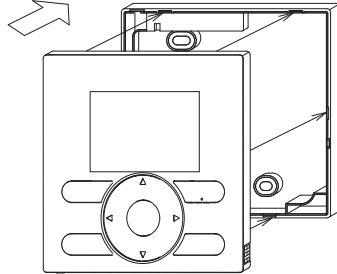

4. Functions and Menu Items of Remote Controller Buttons

4-1 Functions and menu items

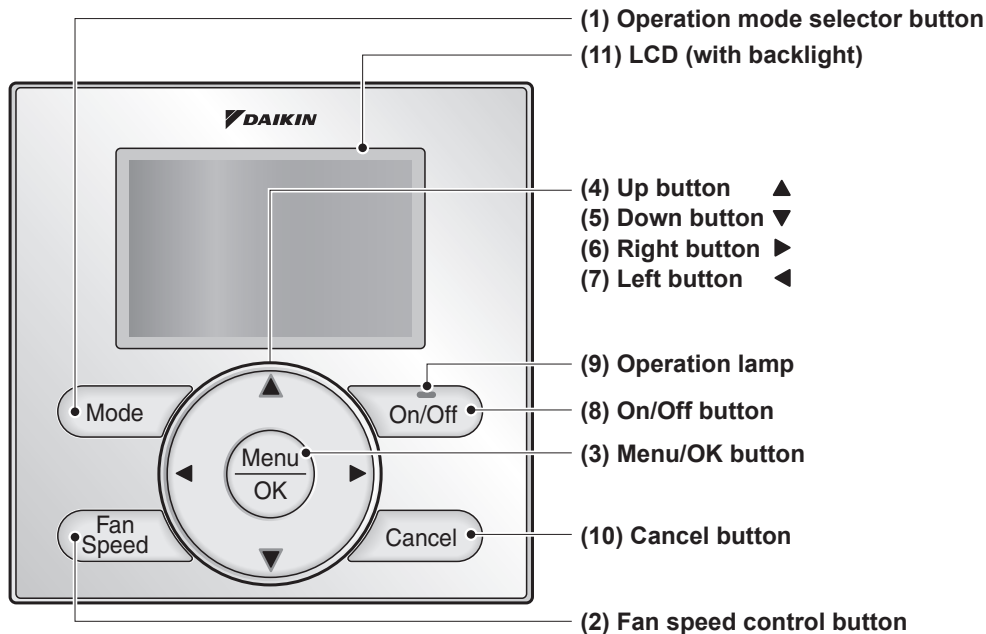

(1) Operation mode selector button
Used to change the mode.

(2) Fan speed control button
Used to change the fan control.

(3) Menu/OK button

- Used to access the main menu.
(For details of the main menu, see the operation manual.)
- Used to enter the item selected.

Main Menu

- *Airflow Direction
- *Individual Airflow Direction
- *Ventilation
- Schedule
- Off Timer
- Celsius / Fahrenheit
- Filter Auto Clean
- Maintenance Information
- Configuration
- Current Settings
- Clock & Calendar
- Daylight Saving Time
- Language

*Depending on connected model

(4) Up button ▲

- Used to raise the setpoint temperature.
- The previous menu items will be highlighted.
(The highlighted items will be scrolled continuously when the button is pressed continuously.)
- Used to change the selected item.

(5) Down button ▼

- Used to lower the setpoint temperature.
- Items below the currently selected item will be highlighted.
(The highlighted items will be scrolled continuously when the button is pressed continuously.)
- Used to change the selected item.

(6) Right button ►

- Used to highlight items to the right of the currently selected item.
- Display contents are changed to next screen per page.

(7) Left button ◀

- Used to highlight items to the left of the currently selected item.
- Display contents are changed to previous screen per page.

(8) On/Off button

Press once to operate, and press once again to stop.

(9) Operation lamp

Green lamp lights up during operation. The lamp will flash if a malfunction occurs.

(10) Cancel button

- Used to return to the previous screen.
- Press and hold this button for 4 seconds or longer to display service settings menu.

(11) LCD (with backlight)

The backlight will illuminate for approximately 30 seconds by pressing any operation button.

Service Settings menu

- Test Operation
- Maintenance Contact
- Field Settings
- *Energy Saving Options
- Prohibit Function
- Min Setpoints Differential
- *Outdoor unit AirNet Address
- Error History
- *Indoor Unit Status
- *Outdoor Unit Status
- Forced Fan ON
- Switch Main Sub Controller
- Filter Indicator
- *Brush/Filter Ind.
- *Disable Filter Auto Clean

*Depending on connected model

⚠ NOTE

- Operate the button while the backlight is illuminated.
- When one indoor unit is controlled by two remote controllers (main / sub) only the first controller to be accessed by the user will illuminate it's backlight.

4-2 Button menu display descriptions

<Service settings menu screen>

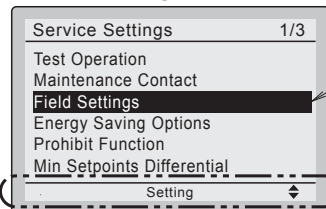

Highlighted display (selected items)

In the highlighted display (selected items) setting screen, button operation descriptions are displayed.

5. Power-on

- Check for completion of indoor/outdoor unit wiring.
- Ensure that covers have been replaced on electrical component boxes for both indoor and outdoor units prior to restoring power.

5-1 The following message is displayed after power-on.
Checking the connection.
Please stand by.

When the above message is displayed, the backlight will not be ON.

In the case that 1 indoor unit is controlled by 2 remote controllers:

Make sure to set the sub remote controller when the above message is displayed. Hold **Mode** button for 4 seconds or longer to set.

When the display is changed from "Main RC" to "Sub RC" the setting is completed.

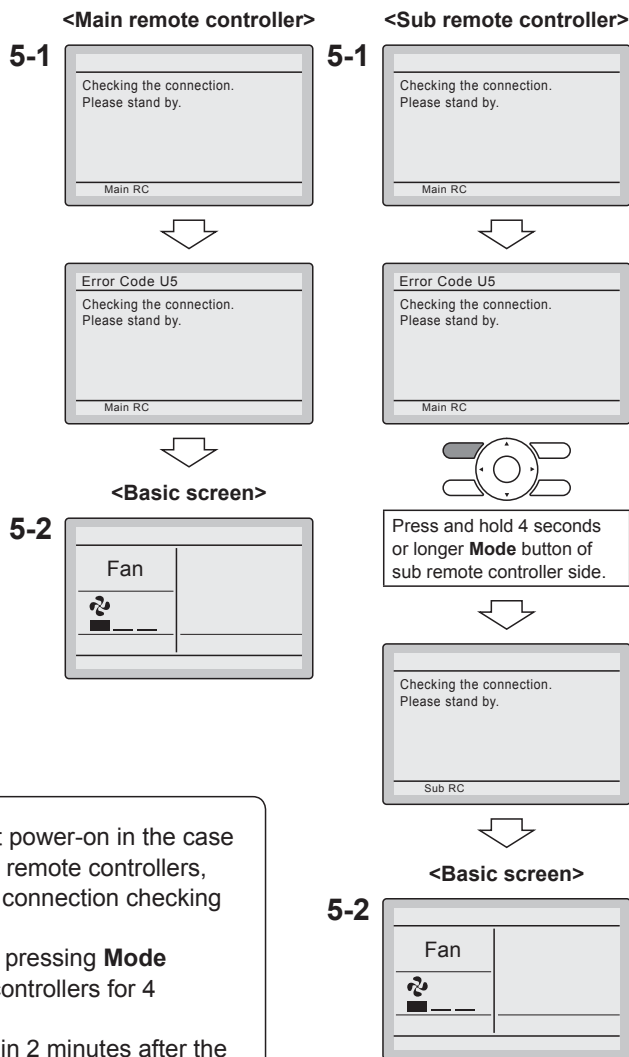

5-2 Basic screen is displayed.

NOTE

If sub remote controller is not set at power-on in the case of one indoor unit controlled by two remote controllers, **Error Code: U5** is displayed in the connection checking screen.

Select the sub remote controller by pressing **Mode** button of either one of the remote controllers for 4 seconds or longer.

If the basic screen is not displayed in 2 minutes after the "Sub RC" is displayed, shut off the power supply and check the wiring.

NOTE

When selecting a different language, refer to **Chapter 12. Language.**
 (See page 22.)

6. Field Settings

6-1 Press and hold **Cancel** button for 4 seconds or longer. Service settings menu is displayed.

6-2 Select **Field Settings** in the Service Settings menu, and press **Menu/OK** button. Field settings screen is displayed.

6-3 Highlight the mode, and select desired "Mode No." by using **▲▼** (Up/Down) button.

6-4 In the case of setting per indoor unit during group control (When Mode No. such as **20**, **21**, **22**, **23**, **25** are selected), highlight the unit No. and select "Indoor unit No." to be set by using **▲▼** (Up/Down) button. (In the case of group setting, this operation is not needed.)

In the case of individual setting per indoor unit, current settings are displayed. And, SECOND CODE NO. " - " means no function.

6-5 Highlight SECOND CODE NO. of the FIRST CODE NO. to be changed, and select desired "SECOND CODE NO." by using **▲▼** (Up/Down) button. Multiple identical mode number settings are available.

In the case of setting for all indoor units in the remote control group, available SECOND CODE NO. is displayed as " * " which means it can be changed. When SECOND CODE NO. is displayed as " - ", there is no function.

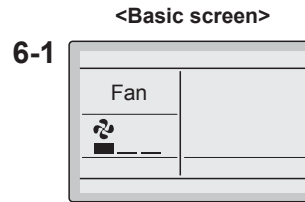

6-1



Press and hold **Cancel** button for 4 seconds or longer during backlight lit.



<Service settings menu screen>

6-2

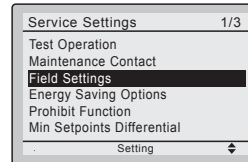

Press **Menu/OK** button.



<Service settings screen>

In the case of individual setting per indoor unit

6-3

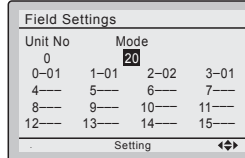

6-4

6-5

In the case of group total setting

6-3

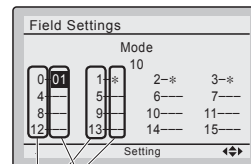

6-5

SECOND CODE NO. FIRST CODE (SW) NO.



Press **Menu/OK** button.

6-6 Press **Menu/OK** button. Setting confirmation screen is displayed.

6-7 Select **Yes** and press **Menu/OK** button. Setting details are determined and field settings screen returns.

6-8 In the case of multiple setting changes, repeat “**6-3**” to “**6-7**”.

6-9 After all setting changes are completed, press **Cancel** button twice.

6-10 Backlight goes out, and **[Checking the connection. Please stand by.]** is displayed for initialization. After the initialization, the basic screen returns.

↓
<Setting confirmation screen>

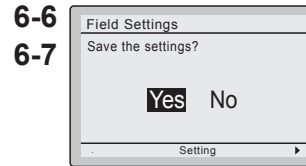

Press **Menu/OK** button.



Setting confirmation

NOTE

- Installation of optional accessories on the indoor unit may require changes to field settings. See the manual of the optional accessory.
- For field setting details related to the indoor unit, see installation manual shipped with the indoor unit.

Mode No. (Note 1)	First Code No.	Description	Second Code No. (Note 2) (Items in bold are factory default settings)												
			01	02	03	04	05	06	07	08	09	10	11	12	13
10 (20)	2	Priority of thermistor sensors for space temperature control	The return air thermistor is primary and the remote controller thermistor is secondary.	The remote controller thermistor is not utilized. Only the return air thermistor will be utilized.	Only the remote controller thermistor will be utilized.	—	—	—	—	—	—	—	—	—	
	5	Room temperature value reported to multizone controllers	Return air thermistor	Thermistor designated by 10-2 above (Note 3)	—	—	—	—	—	—	—	—	—	—	
12 (22)	2	Thermo-on/off deadband (Note 4)	2F (1C)	1F (0.5C)	—	—	—	—	—	—	—	—	—	—	
	1	Thermistor sensor for auto changeover and setback control by the remote controller	Utilize the return air thermistor	Utilize the remote controller thermistor	—	—	—	—	—	—	—	—	—	—	
	3	Access permission level setting	Level 2	Level 3	—	—	—	—	—	—	—	—	—	—	
1c	10	Remote controller thermostat offset (Main RC, Auto mode) (Note 5)	-5.4F (-3.0C)	-4.5F (-2.5C)	-3.6F (-2.0C)	-2.7F (-1.5C)	-1.8F (-1.0C)	-0.9F (-0.5C)	±0.0F (±0.0C)	0.9F (0.5C)	1.8F (1.0C)	2.7F (1.5C)	3.6F (2.0C)	4.5F (2.5C)	5.4F (3.0C)
	11	Remote controller thermostat offset (Sub RC, Auto mode) (Note 5)	-5.4F (-3.0C)	-4.5F (-2.5C)	-3.6F (-2.0C)	-2.7F (-1.5C)	-1.8F (-1.0C)	-0.9F (-0.5C)	±0.0F (±0.0C)	0.9F (0.5C)	1.8F (1.0C)	2.7F (1.5C)	3.6F (2.0C)	4.5F (2.5C)	5.4F (3.0C)
1c	12	Remote controller thermostat offset (Main RC, Cool mode) (Note 5)	-5.4F (-3.0C)	-4.5F (-2.5C)	-3.6F (-2.0C)	-2.7F (-1.5C)	-1.8F (-1.0C)	-0.9F (-0.5C)	±0.0F (±0.0C)	0.9F (0.5C)	1.8F (1.0C)	2.7F (1.5C)	3.6F (2.0C)	4.5F (2.5C)	5.4F (3.0C)
	13	Remote controller thermostat offset (Main RC, Heat mode) (Note 5)	-5.4F (-3.0C)	-4.5F (-2.5C)	-3.6F (-2.0C)	-2.7F (-1.5C)	-1.8F (-1.0C)	-0.9F (-0.5C)	±0.0F (±0.0C)	0.9F (0.5C)	1.8F (1.0C)	2.7F (1.5C)	3.6F (2.0C)	4.5F (2.5C)	5.4F (3.0C)
	14	Remote controller thermostat offset (Sub RC, Cool mode) (Note 5)	-5.4F (-3.0C)	-4.5F (-2.5C)	-3.6F (-2.0C)	-2.7F (-1.5C)	-1.8F (-1.0C)	-0.9F (-0.5C)	±0.0F (±0.0C)	0.9F (0.5C)	1.8F (1.0C)	2.7F (1.5C)	3.6F (2.0C)	4.5F (2.5C)	5.4F (3.0C)
	15	Remote controller thermostat offset (Sub RC, Heat mode) (Note 5)	-5.4F (-3.0C)	-4.5F (-2.5C)	-3.6F (-2.0C)	-2.7F (-1.5C)	-1.8F (-1.0C)	-0.9F (-0.5C)	±0.0F (±0.0C)	0.9F (0.5C)	1.8F (1.0C)	2.7F (1.5C)	3.6F (2.0C)	4.5F (2.5C)	5.4F (3.0C)
1e	2	Setback availability	N/A	Heat only	Cool only	Cool/Heat	—	—	—	—	—	—	—	—	

- Notes)
1. Field settings are normally applied to the entire remote control group, however if individual indoor units in the remote control group require specific settings or for confirmation that settings have been established, utilize the mode number in parenthesis.
 2. Any features not supported by the connected indoor unit will not be displayed.
 3. When mode 10-2-01 is selected, only the return air temperature value is reported to the multizone controller.
 4. The actual default deadband value will depend upon the indoor unit model.
 5. If different offset values are set for cooling and heating modes, the following issues may occur in auto operation mode:
 - The indoor unit may switch more frequently between cooling/heating modes
 - The indoor unit may switch less frequently between cooling/heating modes
 - Setback on/off may happen more frequently
 - Setback on/off may happen less frequently
 To avoid these issues, set the offset values for auto mode.

7. Test Operation

Also see installation manuals furnished with the indoor unit and the outdoor unit.

- Verify that the wiring of the indoor unit and the outdoor unit is completed.
- Ensure that covers have been replaced on electrical component boxes for both indoor and outdoor units prior to restoring power.
- After refrigerant piping, drain piping and electric wiring are completed, clean inside of the indoor unit and decorative panel.
- Perform the test operation according to following procedure.
- To protect the compressor, apply power to the outdoor unit at least 6 hours prior to test operation.
- Set the remote controller display mode to standard or detailed display mode. Refer to Operation Manual for the setting method.

Notes for backlight

- The backlight will be ON for 30 seconds by pressing any button.
- The initial push of the button will only turn on the backlight. While the backlight is turned on, the buttons assigned functionality will be available.

7-1 Set the operation mode to cooling by using the remote controller.

7-2 Press and hold **Cancel** button for 4 seconds or longer. Service settings menu is displayed.

7-3 Select **Test Operation** in the service settings menu, and press **Menu/OK** button. Basic screen returns and message "Test Operation" is displayed at the bottom.

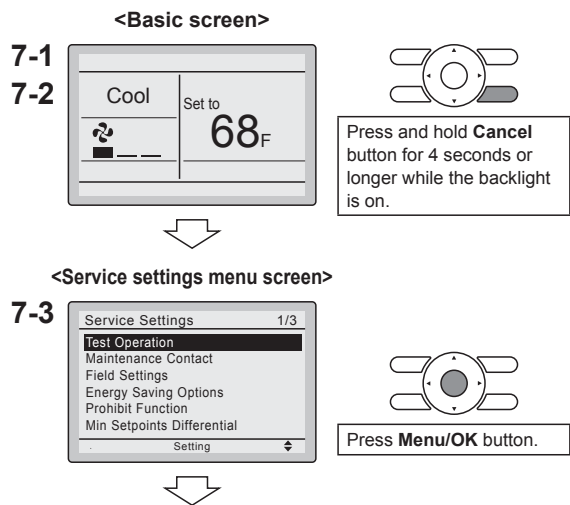

7-4 Press **On/Off** button within 10 seconds, and the test operation starts. Monitor the operation of the indoor unit for a minimum of 10 minutes. During test operation, the indoor unit will continue to cool regardless of the temperature setpoint and room temperature.

* Note) In the case of above-mentioned procedures **7-3** and **7-4** in reverse order, test operation can start as well.

7-5 Press **Menu/OK** button in the basic screen. Main menu is displayed.

7-6 In the case of a model having airflow direction function, select **Airflow Direction** in the main menu and check that airflow direction is actuated according to the setting. For operation of airflow direction setting, see the operation manual.

7-7 After the operation of airflow direction is confirmed, press **Menu/OK** button. Basic screen returns.

7-8 Press and hold **Cancel** button for 4 seconds or longer in the basic screen. Service settings menu is displayed.

7-9 Select **Test Operation** in the service settings menu, and press **Menu/OK** button. Basic screen returns and normal operation is conducted.
* Note) The test operation will automatically finish in 30 minutes.

7-10 Check the functions according to the operation manual.

7-11 When the decorative panel is not installed, shut off the power supply after the test operation finishes.

- If construction activities are planned within the space following the test operation procedure, recommend to the customer that the indoor unit is not operated to prevent contamination from paints, drywall dust and other airborne materials.

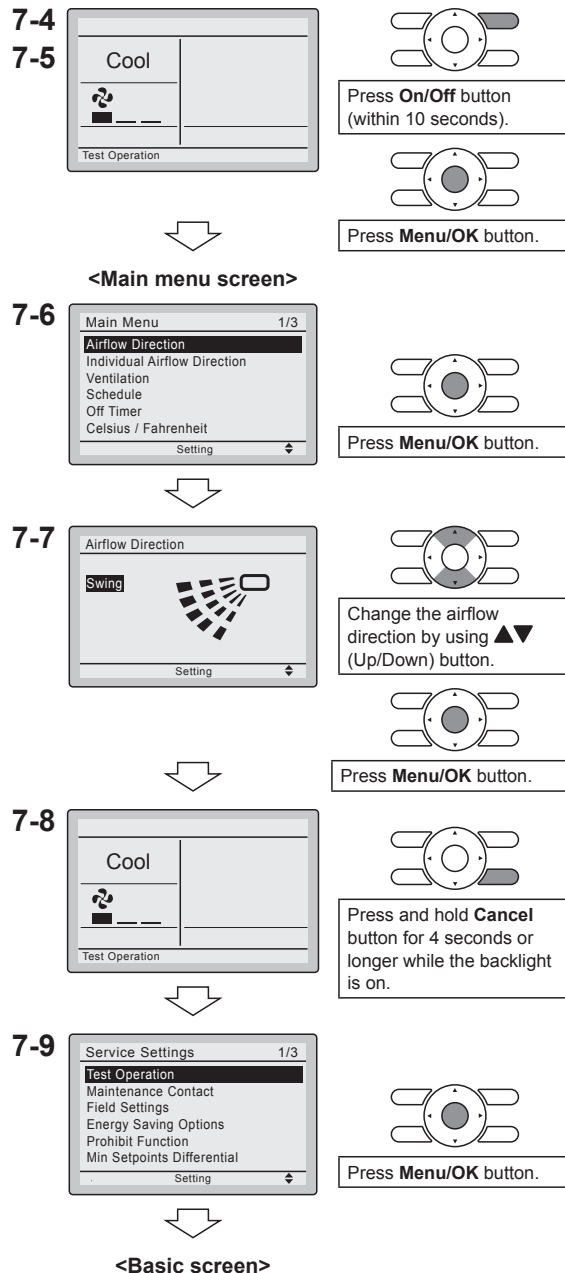

NOTE

- If operation is not possible due to a malfunction, refer to following **Failure diagnosis method**.
- After the test operation finishes, check whether the error code history is displayed on the maintenance information screen of the main menu according to the following procedure.

7-12 Press **Menu/OK** button in the basic screen. Main menu screen is displayed.

7-13 Select **Maintenance Information** in the main menu, and press **Menu/OK** button.

7-14 Maintenance information screen is displayed. Check whether the error code history is displayed on the screen.

* If no error code history is displayed following this procedure the system has normally completed the test operation mode.

7-15 If the error code history is displayed, conduct the failure diagnosis referring to <Error code list> in the installation manual of the indoor unit. After the failure diagnosis finishes, press and hold **On/Off** button for 4 seconds or longer in the maintenance information screen to erase the error code history.

<Basic screen>

7-12

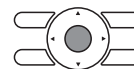
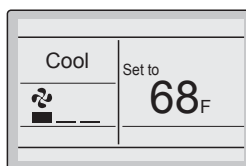

Press **Menu/OK** button.



<Main menu screen>

7-13

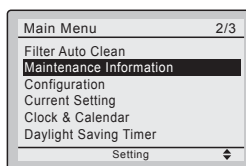

Press **Menu/OK** button.



7-14

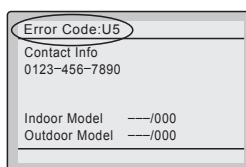

7-15



Press and hold **On/Off** button for 4 seconds or longer during backlight lit.

Failure diagnosis method

- Whenever the remote controller display is blank or displays [**Checking the connection. Please stand by.**], troubleshoot the system with the items in the Description column of the following table.
- If an error occurs, **CODE** is displayed on the LCD as shown to the right. Conduct the failure analysis referring to <Error code list> in the installation manual of the indoor unit. When the unit No. which detected the error during group control is confirmed, refer to **Chapter 8: Procedure for Checking Error History**.

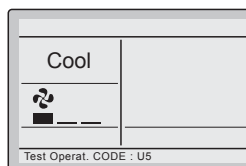

Remote controller display	Description
No display	<ul style="list-style-type: none"> • Power outage, power voltage error or open-phase • Incorrect wiring (between indoor and outdoor units) • Indoor printed-circuit board assembly failure • Remote controller wiring not connected • Remote controller failure • Open fuse or tripped circuit breaker (outdoor unit)
Checking the connection. Please stand by. *	<ul style="list-style-type: none"> • Indoor printed-circuit board assembly failure • Wrong wiring (between indoor and outdoor units)

* [Checking the connection. Please stand by.] will be displayed for up to 90 seconds following the application of power to the indoor unit. This is normal and does not indicate a malfunction.

8. Procedure for Checking Error History

8-1 Press and hold **Cancel** button for 4 seconds or longer in the basic screen. Service settings menu is displayed.

8-2 Select **Error History** in the service settings menu, and press **Menu/OK** button. The error history menu screen is displayed.

8-3 Select **RC Error History** in the error history menu, and press **Menu/OK** button.
Error codes and unit No. can be confirmed in the RC error history screen.

8-4 In the error history, the 10 most recent items are displayed in order of occurrence.

8-5 Press **Cancel** button in the RC error history screen 3 times.
The basic screen returns.

8-1 <Basic screen>



<Service settings menu screen>

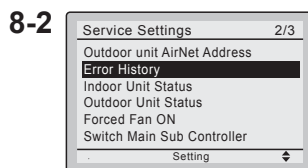

Press **Menu/OK** button.

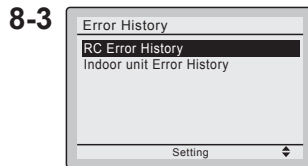

Press **Menu/OK** button.

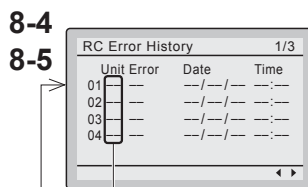

Unit No.
Latest record

9. Adding Maintenance Contact Information

- Registration of the maintenance contact.

9-1 Press and hold **Cancel** button for 4 seconds or longer in the basic screen.
Service settings menu is displayed.

9-2 Select **Maintenance Contact** in the service settings menu, and press **Menu/OK** button. Maintenance contact menu screen is displayed.

9-3 Select **Maintenance Contact**, and press **Menu/OK** button.

9-4 Enter the telephone number.
Scroll through the numbers by using ▲▼ (Up/Down) buttons. Start from the left side. Blank digits should remain as “ - ”.

9-5 Press **Menu/OK** button.
Setting confirmation screen is displayed.

9-6 Select **Yes** and press **Menu/OK** button.
Setting details are saved and service settings menu screen returns.

9-7 Press **Cancel** button once.
The basic screen returns.

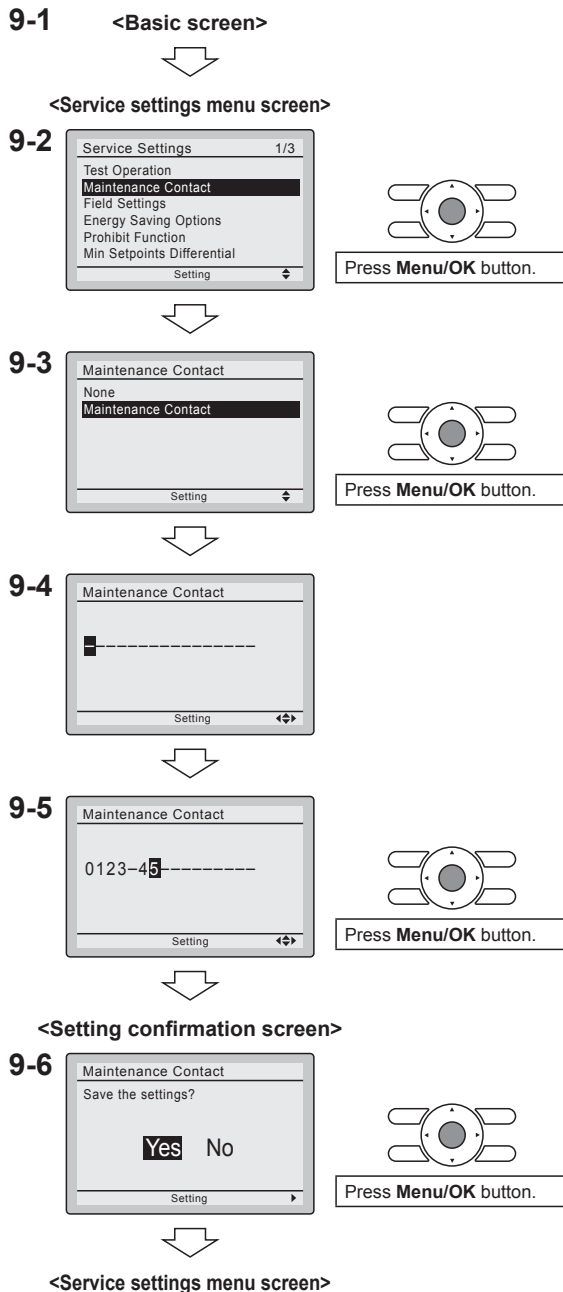

10. Confirming Registered Details

10-1 Press **Menu/OK** button in the basic screen.
Main menu is displayed.
Select **Maintenance Information** in the main menu, and press **Menu/OK** button.

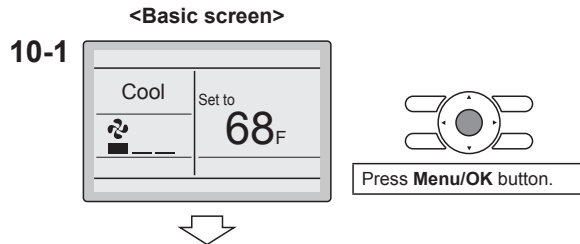

10-2 Press **Cancel** button twice.
The basic screen returns.

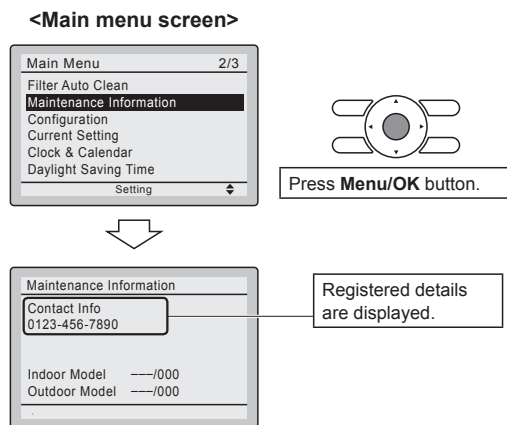

11. Clock & Calendar

11-1 Press **Menu/OK** button in the basic screen.
Main menu is displayed.
Select **Clock & Calendar** in the main menu, press **Menu/OK** button.

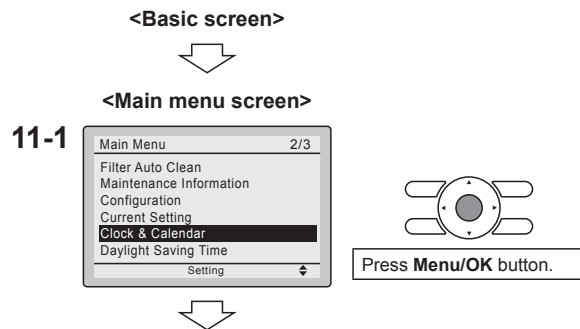

11-2 Press **▲▼** buttons to select **Date & Time** on the clock & calendar screen.
* The date & time screen will appear when **Menu/OK** button is pressed.

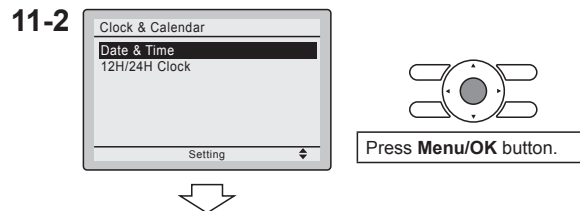

11-3 Select **year, month, day** and **time** by using ◀▶ (Left/Right) button and set by using ▲▼ (Up/Down) button in the date & time screen. Press and hold the button for continuous change of the numeric value.
 * Day of the week is set automatically.

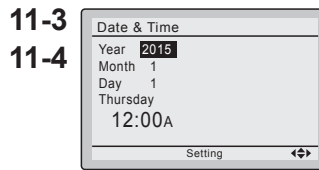

11-4 Press **Menu/OK** button. Setting confirmation screen is displayed.

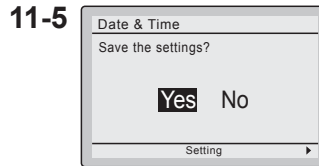

11-5 Select **Yes** and press **Menu/OK** button. Setting details are saved and basic screen returns.

<Basic screen>

* If power outage exceeds 48 hours, reset is needed.

12. Language

12-1 Press **Menu/OK** button in the basic screen. Main menu is displayed. Select **Language** in the main menu, press **Menu/OK** button.

<Basic screen>



<Main menu screen>

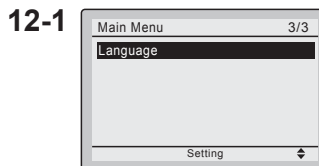

12-2 Press ▲▼ (Up/Down) buttons to select **Language** on the language screen. **English/Français/Español**. Press **Menu/OK** button.

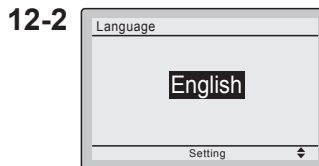

12.9 <BRC082A43> Wireless Remote Controller

CONTENTS

1. SAFETY CONSIDERATIONS.....	2
2. BEFORE INSTALLATION	2
3. REMOTE CONTROLLER INSTALLATION	2
4. RECEIVER INSTALLATION.....	3
5. FIELD SETTING	6
6. TEST OPERATION.....	6

1. SAFETY CONSIDERATIONS

Please read these "SAFETY CONSIDERATIONS" carefully before installing air conditioning equipment and be sure to install it correctly. After completing the installation, make sure that the unit operates properly during the start-up operation. Please instruct the customer on how to operate the unit and keep it maintained.

Also, inform customers that they should store this installation manual along with the operation manual for future reference. This air conditioner comes under the term "appliances not accessible to the general public".

Meaning of warning, caution and note symbols.

⚠ WARNING Indication a potentially hazardous situation which, if not avoided, could result in death or serious injury.

⚠ CAUTION Indication a potentially hazardous situation which, if not avoided, may result in minor or moderate injury. It may also be used to alert against unsafe practices.

⚠ NOTE Indication situation that may result in equipment or property-damage-only accidents.

⚠ WARNING

• **Perform installation work in accordance with this installation manual.**
Improper installation may result in electric shocks or fire.

• **Be sure to use only the specified accessories and parts for installation work.**

Failure to use the specified parts may result in, electric shocks, fire or the unit falling.

• **Before touching electrical parts, turn off the unit.**

• **Do not touch the switch with wet fingers.**

Touching a switch with wet fingers can cause electric shock.

⚠ CAUTION

• **Refer also to the installation manuals attached to the indoor unit and the decoration panel.**
• **Confirm that the following conditions are satisfied prior to installation.**

Ensure that nothing interrupts the operation of the wireless remote controller. (Ensure that there is neither a source of light nor fluorescent lamp near the receiver. Also, ensure that the receiver is not exposed of direct sunlight.)



Ensure that the operation display lamp and other indicators are easy to see.



- The installation position of this receiver is one corner of the decoration panel. Therefore, confirm that its position is set so that the signal from the wireless remote controller can be easily transmitted and its display can be easily seen.
- If both this kit and fresh air intake kit are installed, only one duct chamber shall be used. Refer to the installation manual of the fresh air intake kit (optional hand book).

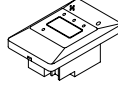
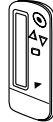

2. BEFORE INSTALLATION

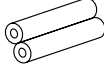

2-1 ACCESSORIES

Check if the following accessories are included with the unit.

Name	(1) Receiver	(2) Wireless remote controller	(3) Remote controller holder
Quantity	1 pc.	1 pc.	1 pc.
Shape			

Name	(4) Dry cell battery LR03 (AM4)	(5) Unit No. label	(6) Screw for installing remote controller holder
Quantity	2 pcs.	1 pc.	2 pcs.
Shape			 M3.5

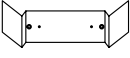
Name	(7) Mounting screw (Black)	(8) Mounting screw	(9) Paper pattern printing
Quantity	2 pcs.	2 pcs.	1 pc.
Shape	 M4	 M5	 3-15/16x1-15/16 (in.)

Name	(10) Winged bar	(11) Operation manual	(12) Installation manual
Quantity	1 pc.	1 pc.	1 pc.
Shape			

2-2 NOTE TO THE INSTALLER

Be sure to instruct the customer how to properly operate the system showing him/her the attached operation manual.

3. REMOTE CONTROLLER INSTALLATION

<Installing wireless remote controller>

- Do not throw the remote controller or impose large shocks. Also, do not store where it may be exposed to moisture or direct sunlight.

- When operating, point the transmitting part of the remote controller in the direction of the receiver.
- The direct transmitting distance of the remote controller is approximately 23 ft..
- The signal cannot be transmitted if something such as curtains blocks the receiver and the remote controller.

Installing to a wall or a pillar

1. Fix the remote controller holder (3) with the screws (6).

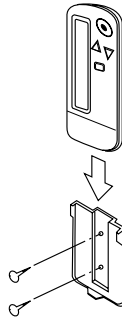

2. Slide the remote controller (2) into the remote controller holder (3) from the top.

How to put the dry cell batteries

1. Remove the back cover of the remote controller (2) to the direction pointed by the arrow mark.
2. Put the dry cell batteries. Use two LR03<AM4> dry cell batteries (4). Put the dry cell batteries (4) correctly to fit their (+) and (-).
3. Close the back cover as before.

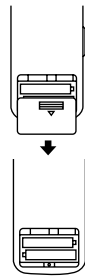

4. RECEIVER INSTALLATION

CAUTION

- Do not install more than 3 receivers in the vicinity of one another.
- With 4 or more units, there is always the possibility of malfunction.

4-1. Preparations before installation

Remove the upper part of the receiver (1).

- Insert the screwdriver (-) here and gently work off the upper part of the receiver (1).

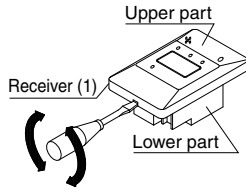

4-2. Determination of address and MAIN/SUB remote controller

If setting multiple wireless remote controllers to operate in 1 room, perform address setting for the receiver and the wireless remote controller. If setting multiple wired remote controllers in 1 room, change the MAIN/SUB switch of the receiver.

4-3. Setting procedure

- Setting the receiver
Set the wireless address switch (SS2) on the PC-board according to the table below.

Unit No.	No.1	No.2	No.3
Wireless address switch (SS2)	1 2 3	1 2 3	1 2 3

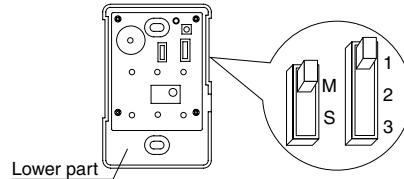
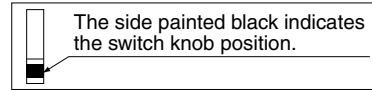

CAUTION

Change the setting so that the internal electronic equipments are not damaged with a pen etc.

When using both a wired and a wireless remote controller for 1 indoor unit, the wired controller should be set to MAIN. Therefore, set the MAIN/SUB switch (SS1) of the receiver to SUB.

	MAIN	SUB
MAIN/SUB switch (SS1)	M S	M S

4-4. Receiver installation

WARNING

Be sure to turn off the power before installation.

CAUTION

<Precautions on transmission wiring>

1. When wiring, run the wiring away the power supply wiring in order to avoid receiving electric noise (external noise).
2. When wiring, refer to the wiring diagram of indoor unit (attached to indoor unit) as well.

WIRING SPECIFICATION

Wiring type	Sheathed wire (2 wire)
Size	AWG18-16
Wiring length	Max 650 ft. (See Note)

NOTE

Keep wires to less than 650 ft. total when using 2 remote controllers (wired or wireless) and when not.

4-5. Attaching the receiver (for ceiling installation)

1. Prepare the ceiling for the receiver.
 - Open a hole in the ceiling for the receiver. (Use paper pattern printing (9)).

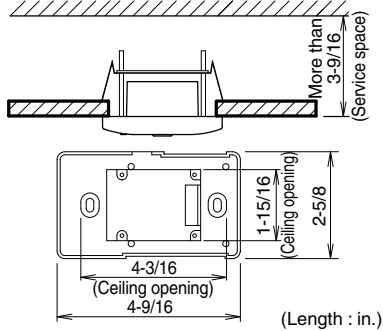

2. Wire the indoor unit and fix the lower part.
 - Install the winged bar (10) to the lower part and fit the part with the screws (8). Then, wire (field supplied) accordingly. (Connect the P1 and P2 terminals on the rear of the lower part to the P1 and P2 terminals on the indoor unit. The P1 and P2 terminals have no polarity.)

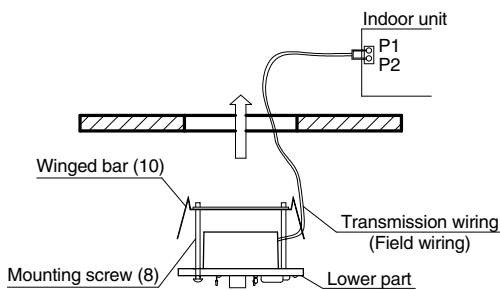

- Insert the lower part into the opening in the ceiling, first by pressing the wings inward to fit the hole and then by pushing from the screws (8) until it sits flat on the ceiling.

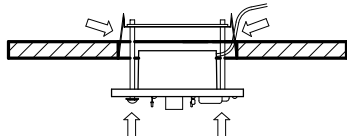

- Tighten the screws (8) until the lower part is fixed in place.

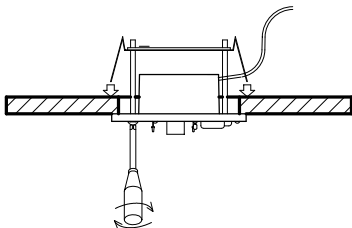

(Tighten both screws (8) evenly. Overtightening may deform the case and possibly make it harder to install the upper part.)

- Attach the upper part of receiver (1).

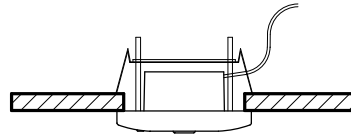

(Install the upper part on the lower part being careful parts are facing in the correct direction. After installation, turn on the power, and test emergency run button.)

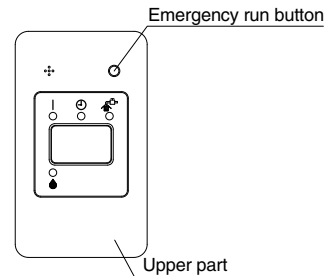

4-6 Attaching the receiver (for wall mounting)

1. Wire the indoor unit.

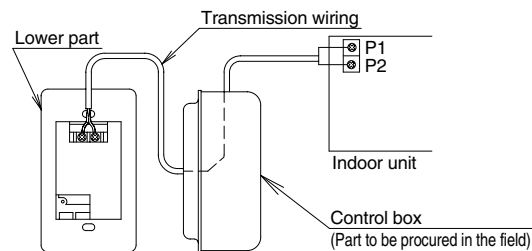

(Connect the P1 and P2 terminals on the rear of the lower part to the P1 and P2 terminals on the indoor unit. Neither of the terminals is polarized, so it is not important if connections are crossed.)

2. Fix the lower part.

- Install the lower part on the control box (field supplied part). (Select as flat a place as possible to install the lower part. Also, be aware of the fact that overtightening the screws (7) may deform the case and possibly make it harder to install the upper part.)

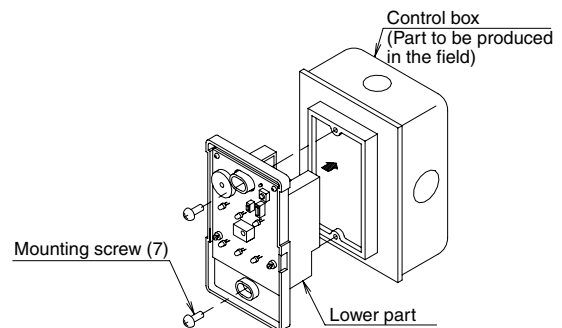

- Attach the upper part of remote controller.
(Install the upper part on the lower part being careful parts are facing in the correct direction. After installation, turn on the power, and test emergency run button.)

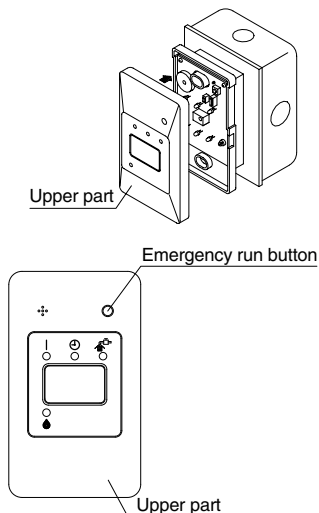

- NOTE**
- The control box and wiring are not included.
 - Do not directly touch the PC-board with your hand.

4-7. Setting the address of wireless remote controller (It is factory set to "1".)
<Setting from the remote controller>

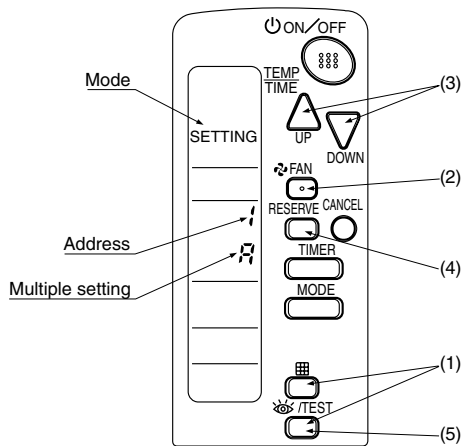

- Hold down the " [Grid] " button and the " [TEST] " button for at least 4 seconds to get the FIELD SET MODE. (Indicated in the display area in the figure at top.)
- Press the " [FAN] " button and select a multiple setting (A/b). Each time the button is pressed the display switches between "A" and "b".

- Press the " [UP] " button and " [DOWN] " button to set the address.

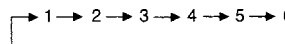

Address can be set from 1 to 6, but set it from 1 to 3 and to same address as the receiver. (The receiver does not work with address from 4 to 6.)

- Press the " [RESERVE] " button to enter the setting.
- Push the " [TEST] " button to quit the FIELD SET MODE and return to the normal display.

<Multiple settings A/b>

When the indoor unit is being operating by outside control (central remote controller, etc.), it sometimes does not respond to ON/OFF and temperature setting commands from this remote controller. Check what setting the customer wants and make the multiple setting as shown below.

Remote controller		Indoor unit	
Multiple setting	Remote controller display	To control other air conditions and units	For other than on left
A: Standard	All items displayed.	Commands other than ON/OFF and temperature setting accepted. (1 LONG BEEP or 3 SHORT BEEPS emitted)	
b: Multi System	Operations remain displayed shortly after execution	All commands accepted. (2 SHORT BEEPS)	

4-8. Stick the Unit No. label on the receiver and the back of the wireless remote controller.

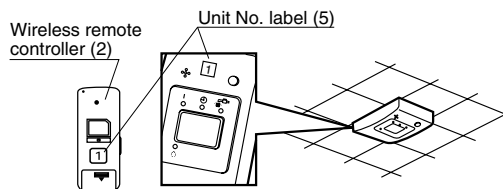

- CAUTION**
- Set the Unit No. of the receiver and the wireless remote controller to be equal. If the settings differ, the signal from the remote controller cannot be transmitted.

5. FIELD SETTING

If optional accessories are mounted on the indoor unit, the indoor unit setting may have to be changed. Refer to the instruction manual (optional hand book) for each optional accessory.

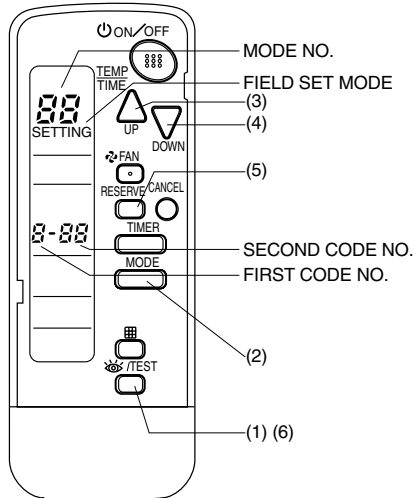

Procedure

- (1) When in the normal mode, press the “ ” button for at least 4 seconds, and the FIELD SET MODE is entered.
- (2) Select the desired MODE NO. with the “ ” button.
- (3) Push the “ ” button and select the FIRST CODE NO..
- (4) Push the “ ” button and select the SECOND CODE NO..
- (5) Push the “ ” button and the present settings are set.
- (6) Push the “ ” button to quit the FIELD SET MODE and return to the normal display.

(Example) If the time to clean air filter is set to “Filter Contamination-Heavy”, set Mode No. to “10”, FIRST CODE NO. to “0”, and SECOND CODE NO. to “02”.

MODE NO.	FIRST CODE NO.	DESCRIPTION OF SETTING	
10	0	Filter Contamination-Heavy/Light (Setting for spacing time of display time to clean air filter) (Setting for when filter contamination is heavy, and spacing time of display time to clean air filter is to be halved)	Long-life type
			Standard type
	3	Spacing time of display time to clean air filter count (Setting for when the filter sign is not to be displayed)	
12 (VRV system)	1	ON/OFF input from outside (Set to enable starting/stopping from remote.)	
	2	Thermostat differential changeover (Set when using remote controller thermostat sensor.)	

MODE NO.	FIRST CODE NO.	SECOND CODE NO.				
		01	02	03		
10	0	Light	Approx. 2,500 hours	Heavy	Approx. 1,250 hours	—
			Approx. 200 hours		Approx. 100 hours	
	3	Display	Do not display	—		
12 (VRV system)	1	Forced OFF input	ON/OFF	—		
	2	2°F	1°F	—		

NOTE

The SECOND CODE NO. is factory set to "01". Do not use any settings not listed in the table. For group control with a wireless remote controller, initial settings for all the indoor units of the group are equal. (For group control, refer to the installation manual attached to the indoor unit for group control.)

6. TEST OPERATION

- Perform test operation according to the instructions in the installation manual attached to the indoor unit.
- After refrigerant piping, drain piping, and electric wiring, operate according to the table to protect the unit.

CAUTION

1. Refer to a malfunction code in the installation manual attached to the outdoor unit if it does not operate.
2. Refer to the installation manual attached to the outdoor unit for individual operation system types. Some of our product types should have the power supply turned ON 6 hours before starting operation in order to electrify crank case heater. Refer to the installation manual attached to the outdoor unit.

Order	Operation
(1)	Open gas side stop valve.
(2)	Open liquid side stop valve.
(3)	Set to cooling with the remote controller and push “ ” button to start operation.
(4)	Push“ ”button twice and operate in TEST OPERATION MODE for 3 minutes.
(5)	Push“ ”button and operate normally.
(6)	Confirm its function according to the operation manual.

12.10 <BRC082A41W, BRC082A42W(S)> Wireless Remote Controller

	1	1	2	3	4	5	6	7
BRC082A41W	1		1	1	1	2	1	2
BRC082A42W		1	1	1	1	2	1	2
BRC082A42S		1	1	1	1	2	1	2

	8	9	10	11	12	13
BRC082A41W	1	1	4	4	1	
BRC082A42W	1	1	3	4	1	1
BRC082A42S	1	1	3	4	1	1

Figure 1

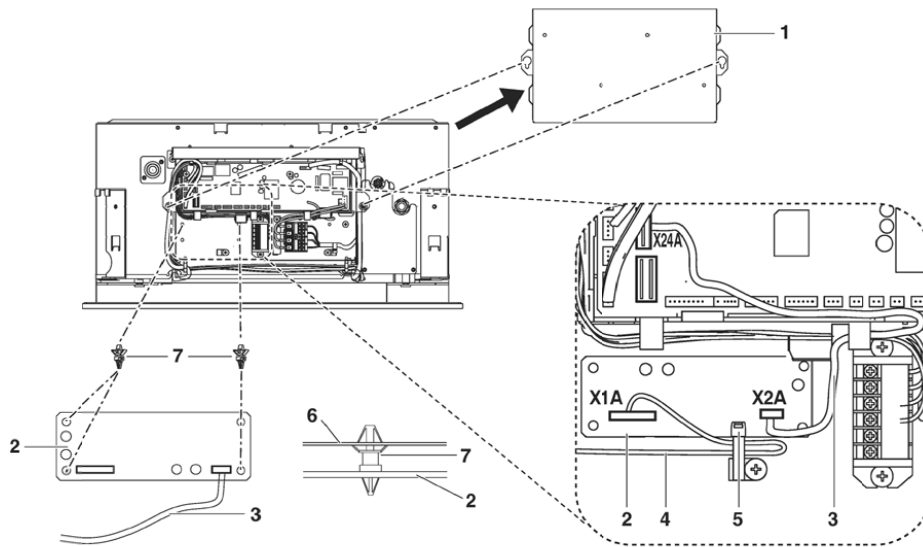

Figure 2

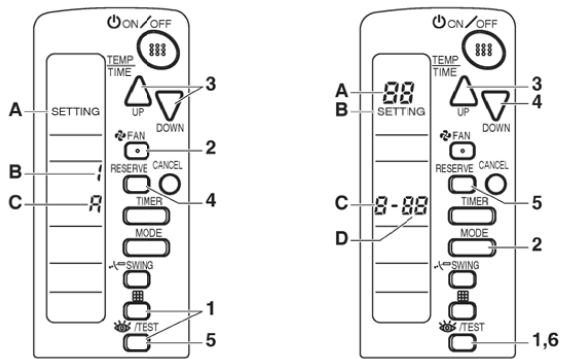

Figure 3

Figure 4

Contents

Safety considerations	1
Before installation	1
Accessories.....	1
Note to the installer.....	1
Remote controller installation	2
Installing the wireless remote controller.....	2
Determination of address and MAIN/SUB remote controller.....	2
Setting procedure.....	2
Installation of the transmitter board.....	3
Installation of the decoration panel	3
Installation of the receiver in case of BRC082A41W	4
Installation of the receiver in case of BRC082A42W/S	4
Field setting	5



READ THIS MANUAL ATTENTIVELY BEFORE STARTING UP THE UNIT. DO NOT THROW IT AWAY. KEEP IT IN YOUR FILES FOR FUTURE REFERENCE.
 IMPROPER INSTALLATION OR ATTACHMENT OF EQUIPMENT OR ACCESSORIES COULD RESULT IN ELECTRIC SHOCK, SHORTCIRCUIT, LEAKS, FIRE OR OTHER DAMAGE TO THE EQUIPMENT. BE SURE ONLY TO USE ACCESSORIES MADE BY DAIKIN WHICH ARE SPECIFICALLY DESIGNED FOR USE WITH THE EQUIPMENT AND HAVE THEM INSTALLED BY A PROFESSIONAL.
 IF UNSURE OF INSTALLATION PROCEDURES OR USE, ALWAYS CONTACT YOUR DAIKIN DEALER FOR ADVICE AND INFORMATION.

The English text is the original instruction. Other languages are translations of the original instructions.

Safety considerations

Please read this "Safety considerations" carefully before installing air conditioning equipment and be sure to install it correctly. After completing the installation, make sure at start up operation that the unit operates properly. Please instruct the customer how to operate the unit and how to perform maintenance.

Meaning of caution symbols



Failure to observe these instructions properly may result in property damage or personal injury.

Information classified as **NOTE** contains instructions to ensure proper use of the equipment.



- Refer also to the installation manual supplied with the indoor unit and the installation manual supplied with the decoration panel.
- There is only 1 possible installation position of this kit into the decoration panel. It is therefore recommended that installation orientation of the decoration panel is confirmed prior to installation of this kit.
- Ensure that nothing interrupts operation of the wireless remote controller.
- Ensure that the signal from the remote controller can easily be transmitted.
- Ensure that the operation display lamp and other indicator lamps can easily be seen.
- Ensure that there is neither a source of light nor a fluorescent lamp near the receiver.
- Ensure that the receiver is not exposed to direct sunlight.

Before installation

Accessories

See figure 1. Check if the following accessories are included with your kit.

- 1 Receiver
- 2 Transmitter board
- 3 Wireless remote controller
- 4 Remote controller holder
- 5 Alkaline battery of type AAA.LR03
- 6 Unit number label
- 7 Screw for installing remote controller holder
- 8 Installation manual
- 9 Operation manual
- 10 Clamp
- 11 Plastic spacer
- 12 Plastic band
- 13 Sealing

Note to the installer

Be sure to instruct the customer how to properly operate the system showing him/her the supplied operation manual.

Remote controller installation

Installing the wireless remote controller

- Do not throw the remote controller or subject it to powerful shocks and do not store the remote controller where it may be exposed to moisture or direct sunlight.
- When operating, point the transmitting part of the remote controller in the direction of the receiver.
- The direct transmitting distance of the remote controller is approximately 23ft (7m).
- The signal cannot be transmitted if something such as curtains blocks the receiver and the remote controller.

Installing to a wall or a pillar

- 1 Turn on all the fluorescent lamps in the room, if any, and find a location where the remote controller signals are properly received by the indoor unit (within 23ft (7m)).

- 2 Fix the remote controller holder with the supplied screws.

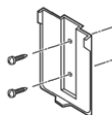

- 3 Mount the remote controller on to the hook of the remote controller holder and then push it toward the wall.

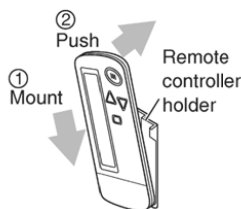

How to insert the batteries

- 1 Slide the back cover to take it off.

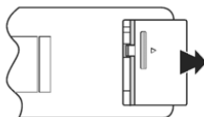

- 2 Insert 2 dry batteries AAA. LR03 (alkaline).

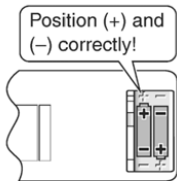

- 3 Replace the back cover.

Determination of address and MAIN/SUB remote controller

- If setting multiple wireless remote controllers to operate in one room, perform address setting for the receiver and the wireless remote controller.
- If using both a wired remote controller and a wireless remote controller with one indoor unit, change the MAIN/SUB switch of the transmitter board.

Setting procedure

Setting the transmitter board

Set the wireless address switch (SS2) on the transmitter board according to the table below.

	Unit No.		
	1	2	3
Wireless address switch (SS2)			

When using both a wired and a wireless remote controller for 1 indoor unit, the wired controller should be set to MAIN. Therefore, set the MAIN/SUB switch (SS1) of the transmitter board to SUB.

	MAIN	SUB
MAIN/SUB switch (SS1)		

Setting the address of the wireless remote controller

(See figure 3)

- A Field Set mode
- B Address (is factory set to "1")
- C Display setting

Setting from the remote controller

- 1 Hold down the button and the /TEST button for at least 4 seconds to enter the Field Set mode. (Indicated in the display area in the figure.)
- 2 Press the FAN button and select an appropriate display setting (A/B). Each time the button is pressed the display switches between "A" and "B". Refer to "Display setting A/B" on page 3 for full comprehension of this feature.
- 3 Press the button and button to set the address.

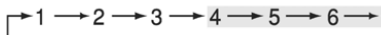

Address can be set from 1 to 6, but set it to 1-3 and to same address as the receiver. (The receiver does not work with address 4-6.)

- 4 Press the RESERVE button to confirm the setting.
- 5 Press the /TEST button to quit the Field Set mode and to return to normal display again.

Display setting *⌘*/*Ⓛ*

The wireless remote controller has 2 possible display settings. The standard setting *⌘* permanently indicates all operational items whereas the multi system display setting *Ⓛ* indicates operations for a limited period of time after execution of settings only.

In case the target indoor unit is simultaneously being controlled;

- by another unit in group control,
- by a wired remote controller,
- by a centralized remote controller.

the indoor unit sometimes does not respond to ON/OFF and temperature setting commands from the wireless remote controller.

In order not to confuse the customer with possible discrepancies between the wireless remote controller display and the actual operation state of the indoor unit, it is recommended to set the display on the wireless remote controller to *Ⓛ* in such a control configuration.

Check what setting the customer prefers and adjust the display setting accordingly.

Display setting	Remote controller display	Result of the display setting in case the target indoor unit is simultaneously being controlled by more than 1 device
<i>⌘</i> : standard	All operational items are permanently displayed.	In the operation mode changeover, temperature setting or the like are carried out from the wireless remote controller, the indoor unit rejects the instruction. (Signal receiving sound, 1 long beep or 3 short beeps) As a result, a display discrepancy between the operation state of the indoor unit and the indication on the wireless remote controller display occurs.
<i>Ⓛ</i> : multi system	Operations only remain displayed for a short time after execution of the commands.	Since the indications on the wireless remote controller are turned off, a discrepancy such as described above no longer occurs.

Affix the unit number label

Affix corresponding unit number labels onto both air outlet of the decoration panel and onto back of the wireless remote controller.

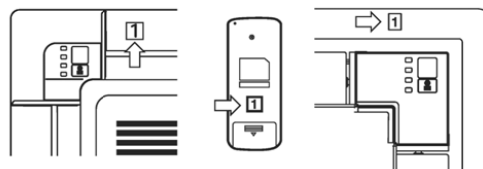

NOTE Set the Unit No. of the receiver and the wireless remote controller to be equal. If the settings differ, the signal from the remote controller cannot be transmitted.

Installation of the transmitter board

(See figure 2)

- 1 Electrical wiring box cover
- 2 Transmitter board
- 3 Shorter wire harness
- 4 Longer wire harness
- 5 Clamp
- 6 Electrical wiring box
- 7 Plastic spacer

- 1 Cut off the power supply.
- 2 Remove the electrical wiring box cover as described in the installation manual supplied with the indoor unit.
- 3 Attach four plastic spacers (7) to the transmitter board (2) and install it in the electrical wiring box (6).
- 4 Connect the shorter wire harness from the X2A connector on transmitter board (2) to X24A connector on the printed circuit board in the electrical wiring box of indoor unit. Lay down the shorter wire harness as shown in the figure 2.
- 5 When the receiver is installed bring the longer wire harness to the electrical wiring box of indoor unit and connect it to X1A connector on the transmitter board.
- 6 Clamp the wire harness by the clamp (5) as shown in the figure 2.

Installation of the decoration panel

Install the decoration panel as described in the installation manual supplied with the decoration panel.

NOTE Make sure that the wire harness (longer one) from the transmitter board is not caught between the indoor unit and the decoration panel, and between the ceiling and the decoration panel.
The installation process of the receiver depends on used decoration panel.

Installation of the receiver in case of BRC082A41W

- 1 Remove the suction grille as described in the installation manual supplied with the decoration panel.
- 2 Detach the brand name plate part of the decoration panel piece, before attaching the decoration panel. This part is not needed hereafter.
- 3 Remove the electrical wiring box cover as described in the installation manual supplied with the indoor unit. (Be sure to turn off power, before removing the electrical wiring box cover.)

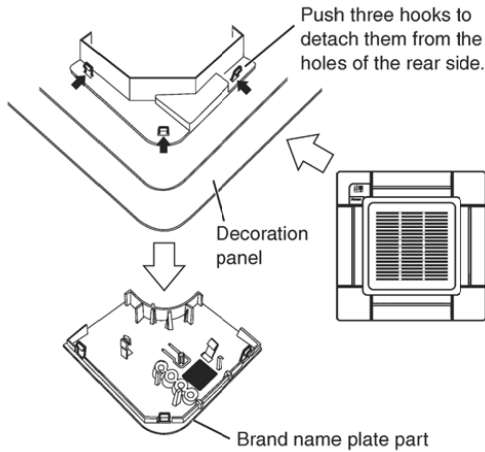

- 4 Pass the wire harness from the receiver through the wiring hole of the decoration panel. Then attach the receiver to the decoration panel. Lead the wire harness to the electrical wiring box on the indoor unit and connect it to X1A connector on the transmitter board.

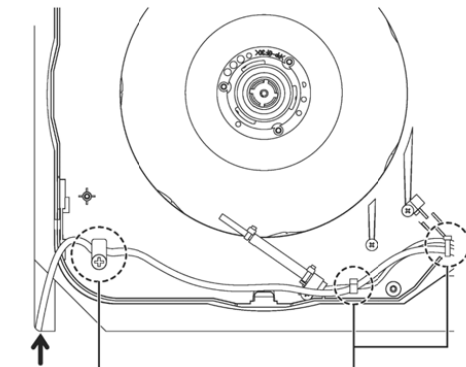
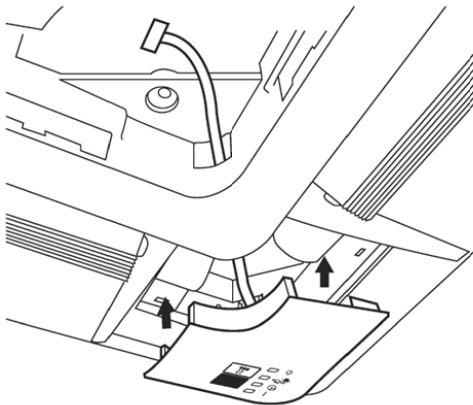

Remove the screw and input the plastic band. Then screw it back. The wire harness goes through the plastic band.

Clamp the wire harness from the receiver to other cables with the clamp.

Installation of the receiver in case of BRC082A42W/S

- 1 Remove the suction grille as described in the installation manual supplied with the decoration panel.
- 2 The receiver (1) should be installed in the corner that is surrounded by 2 square marks on one side and 1 square mark on the other, as shown in the illustration. Then remove the plastic corner cover.

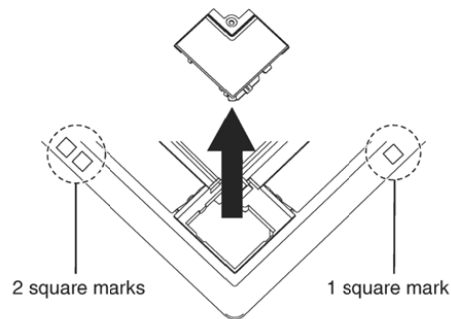

- 3 Break off the plastic cover from back side of the panel.

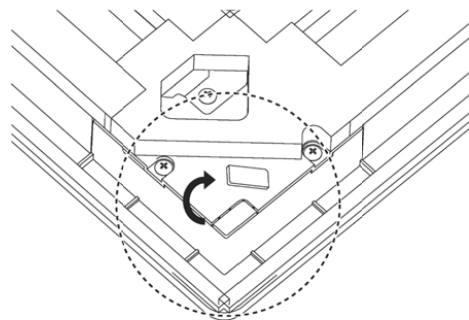

- 4 Pass the wire harness through the hole and insert the cover into its position and screw it.

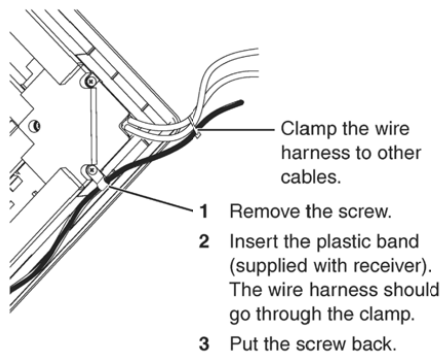
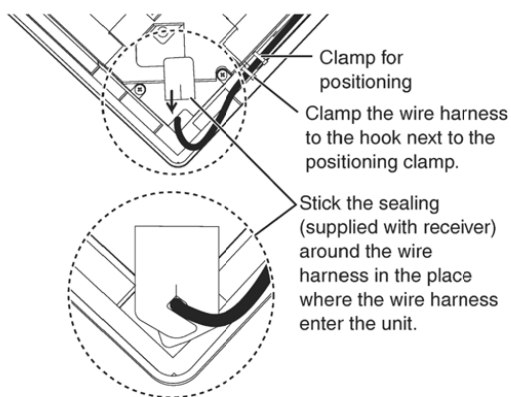
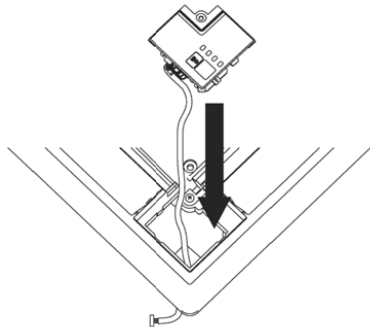





Field setting

If optional accessories are mounted on the indoor unit, the indoor unit setting may have to be changed. Refer to the instruction manual (option handbook) for each optional accessory.

(See figure 4)

- A Mode No.
- B Field Set mode
- C First code No.
- D Second code No.

Procedure

- 1 When in normal mode, hold down the /TEST button for at least 4 seconds to enter the Field Set mode.
- 2 Select the desired Mode No. with the MODE button.
- 3 Press the  button and select the First code No.
- 4 Press the  button and select the Second code No.
- 5 Press the RESERVE button to confirm the settings.
- 6 Press the /TEST button to quit the Field Set mode and to return to normal display again.

Example

If the time to clean air filter is set to "Filter Contamination-Heavy", set Mode No. to "13", First code No. to "02", and Second code No. to "02".

Mode No.	First code No.	Description of setting		Second code No.				
				01		02		03
13	02	Sets operation time until AIR FILTER CLEANING TIME INDICATOR lamp lights up. (When dirt and dust levels are high, change the setting to "Filter Contamination-Heavy".)	Long-life filter	Light	±2,500 hrs.	Heavy	±1,250 hrs.	—
	03	Changes AIR FILTER CLEANING TIME INDICATOR lamp on/off settings.		On		Off		—
13	01	Setting air outlet velocity. This setting is to be changed in function of ceiling height (H).		≤8-7/8ft (≤2.7m)	8-7/8<H≤9-13/16ft (2.7<H≤3.0m)	9-13/16<H≤11-1/2ft (3.0<H≤3.5m)		
	01	Selection of air flow direction. This setting is to be changed when blocking pad optional kit is used.		4-way flow	3-way flow	2-way flow		
	02	Airflow direction range setting. This setting is to be changed when range of swing flap movement needs to be changed.		Upper	Medium	Lower		

NOTE

Factory settings of the Second code No. are marked in grey backgrounds.

Do not use any settings not listed in the table.

For group control with a wireless remote controller, initial settings for all the indoor units of the group are equal.

(For group control, refer to the installation manual supplied with the indoor unit for group control.)