



SiUS092231E

R-410A

Service Manual

Inverter Pair RXL-W Series



[Applied Models]
● Inverter Pair : Heat Pump

Introduction	1
1. Safety Cautions	2
1.1 Warnings and Cautions Regarding Safety of Workers	2
1.2 Warnings and Cautions Regarding Safety of Users	4
2. Icons Used	7
3. Revision History	8
Part 1 General Information	9
1. Applicable Models	10
2. Functions	11
Part 2 Specifications	12
1. Specifications	13
1.1 Wall Mounted Type	13
1.2 Floor Standing Type	16
1.3 Duct Concealed Type	18
Part 3 Printed Circuit Board Connector Wiring Diagram	20
1. Indoor Unit	21
1.1 FTX09/12WMVJU9	21
1.2 FTX15WMVJU9	23
1.3 FTX18/24WVJU9	25
1.4 FVXS09/12/15WVJU9	27
1.5 FDMQ12/18/24WVJU9	29
2. Wired Remote Controller	31
2.1 BRC1E73	31
3. Wireless Remote Controller Receiver for FDMQ Series	32
3.1 BRC082A43	32
4. Outdoor Unit	33
4.1 RXL09WMVJU9	33
4.2 RXL12WMVJU9	35
4.3 RXL15WMVJU9	37
4.4 RXL18/24WMVJU9	38
Part 4 Functions and Control	40
1. Common Functions	42
1.1 Temperature Control	42
1.2 Frequency Principle	42
2. Functions for FTX, FVXS Series	44
2.1 Airflow Direction Control	44
2.2 COMFORT AIRFLOW Operation	47
2.3 Fan Speed Control for Indoor Unit	48
2.4 Program Dry Operation	49
2.5 Automatic Cooling/Heating Changeover	50

2.6	Thermostat Control.....	51
2.7	NIGHT SET Mode	52
2.8	ECONO Operation	53
2.9	INTELLIGENT EYE Operation	54
2.10	POWERFUL Operation	55
2.11	Clock Setting	56
2.12	WEEKLY TIMER Operation	57
2.13	Other Functions.....	63
3.	Functions for FDMQ Series.....	64
3.1	Fan Speed Control for Indoor Unit	64
3.2	Program Dry Operation	65
3.3	Clock and Calendar Setting (With BRC1E73).....	66
3.4	Schedule Timer Operation (With BRC1E73).....	68
3.5	Drain Pump Control.....	71
3.6	Hot Start Control (In Heating Operation Only).....	73
3.7	Other Functions.....	74
4.	Thermistor Functions	75
5.	Control Specification	76
5.1	Mode Hierarchy	76
5.2	Frequency Control.....	76
5.3	Controls at Mode Changing/Start-up.....	78
5.4	Discharge Pipe Temperature Control.....	80
5.5	Input Current Control.....	81
5.6	High Pressure Protection Control	82
5.7	Freeze-up Protection Control	83
5.8	Heating Peak-cut Control	84
5.9	Outdoor Fan Control.....	85
5.10	Liquid Compression Protection Function.....	85
5.11	Defrost Control	86
5.12	Electronic Expansion Valve Control	87
5.13	Malfunctions	90
Part 5 Remote Controller		91
1.	Applicable Remote Controller	92
2.	ARC466A21	93
3.	ARC466A37	95
4.	ARC480A8	97
5.	BRC082A43	98
6.	BRC944B2	100
7.	BRC1E73	101
Part 6 Service Diagnosis		107
1.	General Problem Symptoms and Check Items	109
2.	Troubleshooting with LED	110
2.1	Indoor Unit.....	110
2.2	Outdoor Unit.....	111

3.	Service Diagnosis	112
3.1	ARC480 Series.....	112
3.2	ARC466 Series.....	115
3.3	BRC1E73	118
3.4	BRC082A43	120
4.	Error Codes and Description.....	124
5.	Troubleshooting for FTX, FVXS Series	125
5.1	Indoor Unit PCB Abnormality	125
5.2	Freeze-up Protection Control/Heating Peak-cut Control	127
5.3	Indoor Fan Motor (DC Motor) or Related Abnormality	129
5.4	Thermistor or Related Abnormality.....	133
5.5	Low-voltage Detection or Over-voltage Detection.....	134
5.6	Signal Transmission Error (Between Indoor Unit and Outdoor Unit).....	136
5.7	Unspecified Voltage (Between Indoor Unit and Outdoor Unit)	138
6.	Troubleshooting for FDMQ Series	139
6.1	Indoor Unit PCB Abnormality	139
6.2	Drain Level Control System Abnormality.....	140
6.3	Indoor Fan Motor (DC Motor) or Related Abnormality	141
6.4	Indoor Fan PCB Abnormality.....	143
6.5	Humidifier or Related Abnormality.....	144
6.6	Thermistor or Related Abnormality.....	145
6.7	Remote Controller Thermistor Abnormality	146
6.8	Low-voltage Detection or Over-voltage Detection.....	147
6.9	Signal Transmission Error (Between Indoor and Outdoor Unit)	149
6.10	Signal Transmission Error (Between Indoor Unit and Remote Controller).....	151
6.11	Signal Transmission Error (Between MAIN/SUB Remote Controllers)	152
6.12	Mismatching of Indoor Unit and Outdoor Unit	153
7.	Troubleshooting for Outdoor Unit.....	154
7.1	Outdoor Unit PCB Abnormality.....	154
7.2	Actuation of High Pressure Switch	155
7.3	OL Activation (Compressor Overload) or HPS Activation (High Pressure Switch).....	157
7.4	OL Activation (Compressor Overload)	160
7.5	Compressor Lock	163
7.6	DC Fan Lock	164
7.7	Input Overcurrent Detection	165
7.8	Four Way Valve Abnormality	167
7.9	Discharge Pipe Temperature Control.....	169
7.10	High Pressure Control in Cooling	170
7.11	System Shutdown due to Temperature Abnormality in the Compressor	172
7.12	Compressor Sensor System Abnormality	173
7.13	Position Sensor Abnormality	174
7.14	Thermistor or Related Abnormality (Outdoor Unit).....	177
7.15	Electrical Box Temperature Rise	179
7.16	Radiation Fin Temperature Rise	181
7.17	Output Overcurrent Detection	183
7.18	Signal Transmission Error on Outdoor Unit PCB	185

8. Check	186
8.1 Thermistor Resistance Check	186
8.2 Indoor Fan Motor Connector Check	187
8.3 Power Supply Waveform Check.....	189
8.4 Electronic Expansion Valve Check.....	189
8.5 Four Way Valve Performance Check	190
8.6 Inverter Unit Refrigerant System Check.....	192
8.7 Inverter Analyzer Check.....	193
8.8 Outdoor Fan Motor Check.....	196
8.9 Installation Condition Check.....	197
8.10 Discharge Pressure Check.....	197
8.11 Outdoor Fan System Check.....	198
8.12 Main Circuit Short Check.....	198
8.13 Power Module Check	201

Part 7 Trial Operation and Field Settings 204

1. Pump Down Operation.....	205
2. Forced Cooling Operation	206
3. Trial Operation	209
4. Field Settings for FTX, FVXS Series	213
4.1 Temperature Display Switch	213
4.2 When 2 Units are Installed in 1 Room.....	214
4.3 Jumper and Switch Settings.....	217
4.4 Service Mode of Wireless Remote Controller	218
5. Field Settings for FDMQ Series	221
5.1 How to Change the Field Settings.....	221
5.2 Overview of Field Settings.....	224
5.3 MAIN/SUB and Address Setting for Wireless Remote Controller	225
6. Field Settings for Outdoor Unit.....	228
6.1 Facility Setting (cooling at low outdoor temperature)	228
6.2 Warmer Airflow Setting.....	230
6.3 Drain Pan Heater.....	232
7. Silicone Grease on Power Transistor/Diode Bridge.....	233

Part 8 Appendix 234

1. Piping Diagrams.....	235
1.1 Indoor Unit.....	235
1.2 Outdoor Unit.....	237
2. Wiring Diagrams.....	240
2.1 Indoor Unit.....	240
2.2 Outdoor Unit.....	245
3. Operation Limit.....	249

Introduction

1. Safety Cautions.....	2
1.1 Warnings and Cautions Regarding Safety of Workers.....	2
1.2 Warnings and Cautions Regarding Safety of Users.....	4
2. Icons Used	7
3. Revision History	8

1. Safety Cautions

Be sure to read the following safety cautions before conducting repair work.

After the repair work is complete, be sure to conduct a test operation to ensure that the equipment operates normally, and explain the cautions for operating the product to the customer.

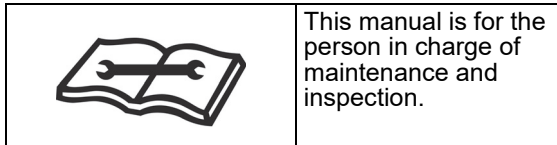

Caution Items

The caution items are classified into **Warning** and **Caution**. The **Warning** items are especially important since death or serious injury can result if they are not followed closely. The **Caution** items can also lead to serious accidents under some conditions if they are not followed. Therefore, be sure to observe all the safety caution items described below.

Pictograms

△ This symbol indicates an item for which caution must be exercised.

The pictogram shows the item to which attention must be paid.







○ This symbol indicates a prohibited action.







The prohibited item or action is shown in the illustration or near the symbol.







● This symbol indicates an action that must be taken, or an instruction.



The instruction is shown in the illustration or near the symbol.

1.1 Warnings and Cautions Regarding Safety of Workers









 Warning	
<p>Do not store equipment in a room with fire sources (e.g., naked flames, gas appliances, electric heaters).</p>	
<p>Be sure to disconnect the power cable from the socket before disassembling equipment for repair. Working on equipment that is connected to the power supply may cause an electrical shock. If it is necessary to supply power to the equipment to conduct the repair or inspect the circuits, do not touch any electrically charged sections of the equipment.</p>	
<p>If refrigerant gas is discharged during repair work, do not touch the discharged refrigerant gas. Refrigerant gas may cause frostbite.</p>	
<p>When disconnecting the suction or discharge pipe of the compressor at the welded section, evacuate the refrigerant gas completely at a well-ventilated place first. If there is gas remaining inside the compressor, the refrigerant gas or refrigerating machine oil discharges when the pipe is disconnected, and it may cause injury.</p>	
<p>If refrigerant gas leaks during repair work, ventilate the area. Refrigerant gas may generate toxic gases when it contacts flames.</p>	







 Warning	
<p>Be sure to discharge the capacitor completely before conducting repair work. The step-up capacitor supplies high-voltage electricity to the electrical components of the outdoor unit. A charged capacitor may cause an electrical shock.</p>	
<p>Do not turn the air conditioner on or off by plugging in or unplugging the power cable. Plugging in or unplugging the power cable to operate the equipment may cause an electrical shock or fire.</p>	
<p>Be sure to wear a safety helmet, gloves, and a safety belt when working in a high place (more than 2 m (6.5 ft)). Insufficient safety measures may cause a fall.</p>	
<p>In case of R-32 / R-410A refrigerant models, be sure to use pipes, flare nuts and tools intended for the exclusive use with the R-32 / R-410A refrigerant. The use of materials for R-22 refrigerant models may cause a serious accident, such as a damage of refrigerant cycle or equipment failure.</p>	
<p>Do not mix air or gas other than the specified refrigerant (R-32 / R-410A / R-22) in the refrigerant system. If air enters the refrigerant system, an excessively high pressure results, causing equipment damage and injury.</p>	







 Caution	
<p>Do not repair electrical components with wet hands. Working on the equipment with wet hands may cause an electrical shock.</p>	
<p>Do not clean the air conditioner with water. Washing the unit with water may cause an electrical shock.</p>	
<p>Be sure to provide an earth / grounding when repairing the equipment in a humid or wet place, to avoid electrical shocks.</p>	
<p>Be sure to turn off the power switch and unplug the power cable when cleaning the equipment. The internal fan rotates at a high speed, and may cause injury.</p>	
<p>Be sure to conduct repair work with appropriate tools. The use of inappropriate tools may cause injury.</p>	





 Caution	
<p>Be sure to check that the refrigerating cycle section has cooled down enough before conducting repair work. Working on the unit when the refrigerating cycle section is hot may cause burns.</p>	
<p>Conduct welding work in a well-ventilated place. Using the welder in an enclosed room may cause oxygen deficiency.</p>	

1.2 Warnings and Cautions Regarding Safety of Users

 Warning	
<p>Do not store the equipment in a room with fire sources (e.g., naked flames, gas appliances, electric heaters).</p>	
<p>Be sure to use parts listed in the service parts list of the applicable model and appropriate tools to conduct repair work. Never attempt to modify the equipment. The use of inappropriate parts or tools may cause an electrical shock, excessive heat generation or fire.</p>	
<p>If the power cable and lead wires are scratched or have deteriorated, be sure to replace them. Damaged cable and wires may cause an electrical shock, excessive heat generation or fire.</p>	
<p>Do not use a joined power cable or extension cable, or share the same power outlet with other electrical appliances, since it may cause an electrical shock, excessive heat generation or fire.</p>	
<p>Be sure to use an exclusive power circuit for the equipment, and follow the local technical standards related to the electrical equipment, the internal wiring regulations, and the instruction manual for installation when conducting electrical work. Insufficient power circuit capacity and improper electrical work may cause an electrical shock or fire.</p>	
<p>Be sure to use the specified cable for wiring between the indoor and outdoor units. Make the connections securely and route the cable properly so that there is no force pulling the cable at the connection terminals. Improper connections may cause excessive heat generation or fire.</p>	
<p>When wiring between the indoor and outdoor units, make sure that the terminal cover does not lift off or dismount because of the cable. If the cover is not mounted properly, the terminal connection section may cause an electrical shock, excessive heat generation or fire.</p>	
<p>Do not damage or modify the power cable. Damaged or modified power cables may cause an electrical shock or fire. Placing heavy items on the power cable, or heating or pulling the power cable may damage it.</p>	





 Warning	
<p>Do not mix air or gas other than the specified refrigerant (R-32 / R-410A / R-22) in the refrigerant system. If air enters the refrigerant system, an excessively high pressure results, causing equipment damage and injury.</p>	
<p>If the refrigerant gas leaks, be sure to locate the leaking point and repair it before charging the refrigerant. After charging the refrigerant, make sure that there is no leak. If the leaking point cannot be located and the repair work must be stopped, be sure to pump-down, and close the service valve, to prevent refrigerant gas from leaking into the room. Refrigerant gas itself is harmless, but it may generate toxic gases when it contacts flames, such as those from fan type and other heaters, stoves and ranges.</p>	
<p>When relocating the equipment, make sure that the new installation site has sufficient strength to withstand the weight of the equipment. If the installation site does not have sufficient strength or the installation work is not conducted securely, the equipment may fall and cause injury.</p>	
<p>Check to make sure that the power cable plug is not dirty or loose, then insert the plug into a power outlet securely. If the plug is dusty or has a loose connection, it may cause an electrical shock or fire.</p>	
<p>When replacing the coin battery in the remote controller, be sure to dispose of the old battery to prevent children from swallowing it. If a child swallows the coin battery, see a doctor immediately.</p>	

 Caution	
<p>Installation of a leakage breaker is necessary in some cases depending on the conditions of the installation site, to prevent electrical shocks.</p>	
<p>Do not install the equipment in a place where there is a possibility of combustible gas leaks. If combustible gas leaks and remains around the unit, it may cause a fire.</p>	
<p>Check to see if parts and wires are mounted and connected properly, and if connections at the soldered or crimped terminals are secure. Improper installation and connections may cause excessive heat generation, fire or an electrical shock.</p>	
<p>If the installation platform or frame has corroded, replace it. A corroded installation platform or frame may cause the unit to fall, resulting in injury.</p>	
<p>Check the earth / grounding, and repair it if the equipment is not properly earthed / grounded. Improper earth / grounding may cause an electrical shock.</p>	

 Caution	
Be sure to measure insulation resistance after the repair, and make sure that the resistance is 1 MΩ or higher. Faulty insulation may cause an electrical shock.	
Be sure to check the drainage of the indoor unit after the repair. Faulty drainage may cause water to enter the room and wet the furniture and floor.	
Do not tilt the unit when removing it. The water inside the unit may spill and wet the furniture and floor.	

2. Icons Used

The following icons are used to attract the attention of the reader to specific information.

Icon	Type of Information	Description
 Warning	Warning	Warning is used when there is danger of personal injury.
 Caution	Caution	Caution is used when there is danger that the reader, through incorrect manipulation, may damage equipment, lose data, get an unexpected result or have to restart (part of) a procedure.
 Note	Note	Note provides information that is not indispensable, but may nevertheless be valuable to the reader, such as tips and tricks.
 Reference	Reference	Reference guides the reader to other places in this binder or in this manual, where he/she will find additional information on a specific topic.

3. Revision History

Month/Year	Version	Revised contents
11 / 2022	SiUS092231E	First edition

Part 1

General Information

1. Applicable Models	10
2. Functions.....	11

1. Applicable Models

Indoor Unit

Wall mounted type	Floor standing type	Duct concealed type
FTX09WMVJU9	FVXS09WVJU9	FDMQ12WVJU9
FTX12WMVJU9	FVXS12WVJU9	FDMQ18WVJU9
FTX15WMVJU9	FVXS15WVJU9	FDMQ24WVJU9
FTX18WVJU9		
FTX24WVJU9		

Outdoor Unit

RXL09WMVJU9
RXL12WMVJU9
RXL15WMVJU9
RXL18WMVJU9
RXL24WMVJU9

2. Functions

Category	Functions	Wall Mounted FTX				Floor Standing FVXS	Duct Concealed FDMQ	
		09	12	15	18/24		Wired R/C	Wireless R/C
Basic Function	Inverter (with inverter power control)	●	●	●	●	●	●	●
	Operation limit	Refer to page 249						
	PAM control	●	●	●	●	●	●	●
	Standby electricity saving	●	—	●	—	—	—	—
Compressor	Swing compressor	●	●	●	●	●	●	●
	Reluctance DC motor	●	●	●	●	●	●	●
Comfortable Airflow	Power-airflow flap (horizontal blade)	●	●	—	—	●	—	—
	Power-airflow dual flaps (horizontal blades)	—	—	●	●	—	—	—
	Wide-angle louvers (vertical blades)	●	●	●	●	●	—	—
	Auto-swing (up and down)	●	●	●	●	●	—	—
	Auto-swing (right and left)	—	—	—	●	—	—	—
	3-D airflow	—	—	—	●	—	—	—
	COMFORT AIRFLOW operation	●	●	●	●	—	—	—
Comfort Control	Auto fan speed	●	●	●	●	●	●	—
	Switchable fan speed	5 steps	5 steps	5 steps	5 steps	5 steps	3 steps	3 steps
	Indoor unit quiet operation	●	●	●	●	●	—	—
	OUTDOOR UNIT QUIET operation (manual)	—	—	—	●	●	—	—
	INTELLIGENT EYE operation (auto energy saving)	—	—	—	●	—	—	—
	2 selectable temperature sensors	—	—	—	—	—	●	—
	Quick warming function	●	●	●	●	—	●	●
	Hot-start function	●	●	●	●	●	●	●
	Automatic defrosting	●	●	●	●	●	●	●
Operation	Automatic cooling/heating changeover	●	●	●	●	●	●	●
	Program dry operation	●	●	●	●	●	●	●
	Fan only	●	●	●	●	●	●	●
Lifestyle Convenience	Inverter POWERFUL operation	●	●	●	●	●	—	—
	ECONO operation	●	●	●	●	●	—	—
	Indoor unit ON/OFF switch	●	●	●	●	●	—	—
	Emergency operation switch	—	—	—	—	—	—	●
	Signal receiving sign	●	●	●	●	●	—	●★1
Health and Cleanliness	Titanium apatite deodorizing filter	●	●	●	●	●	—	—
	Air filter (prefilter)	●	●	●	●	●	—	—
	Wipe-clean flat panel	●	●	●	●	●	—	—
	Silver ion anti-bacterial drain pan	—	—	—	—	—	●	●
	Filter cleaning indicator	—	—	—	—	—	●	●
Remote Control & Timer	WEEKLY TIMER operation	—	—	—	●	●	—	—
	Schedule timer	—	—	—	—	—	●	—
	24-hour ON/OFF TIMER	—	—	—	●	●	●	—
	72-hour ON/OFF TIMER	—	—	—	—	—	—	●
	Count up-down ON/OFF timer	●	●	●	—	—	—	●
	Off timer (turns unit off after set time)	—	—	—	—	—	●	—
	Setpoint auto reset	—	—	—	—	—	●	—
	Setpoint range set	—	—	—	—	—	●	—
	NIGHT SET mode	●	●	●	●	●	—	—
	Remote controller with back light	●	●	●	●	●	●	—
	DIII-NET compatible (adaptor)	Option	Option	Option	Option	Option	Option	Option
	Wireless LAN connection	Option	Option	Option	Option	Option	Option	Option
	Worry Free (Reliability & Durability)	Auto-restart (after power failure)	●	●	●	●	●	●
Self-diagnosis (R/C, LED)		●	●	●	●	●	●	●
Anti-corrosion treatment of outdoor heat exchanger		●	●	●	●	●	●	●
Multi-split/split type compatible indoor unit		—	—	—	—	●	●	●
Work & Servicing	Chargeless	32.8 ft. (10 m)	32.8 ft. (10 m)	32.8 ft. (10 m)	32.8 ft. (10 m)	32.8 ft. (10 m)	32.8 ft. (10 m)	32.8 ft. (10 m)
	Drain pump	—	—	—	—	—	●	●
	Either side drain (right or left)	●	●	●	●	—	—	—
	Low temperature cooling operation	-4°F ★2 (-20°C)	-4°F ★2 (-20°C)	-4°F ★2 (-20°C)	-4°F ★2 (-20°C)	-4°F ★2 (-20°C)	-4°F ★2 (-20°C)	-4°F ★2 (-20°C)
	°F/°C changeover R/C temperature display (factory setting: °F)	●	●	●	●	●	●	— (°F only)

● : Available
 — : Not available

★1 : Receiving sound only
 ★2 : Below 50°F (10°C):

Below 14°F (-10°C):

Needs setting on outdoor unit.
 09/12/15 class cutting jumper on the main PCB
 18/24 class switch on the service monitor PCB
 Need to install the air direction adjustment grille.

Part 2 Specifications

1. Specifications	13
1.1 Wall Mounted Type	13
1.2 Floor Standing Type	16
1.3 Duct Concealed Type.....	18

1. Specifications

1.1 Wall Mounted Type

Model	Indoor Unit		FTX09WMVJU9		FTX12WMVJU9	
	Outdoor Unit		RXL09WMVJU9		RXL12WMVJU9	
			Cooling	Heating	Cooling	Heating
Power Supply			1 ϕ , 208 - 230 V, 60 Hz		1 ϕ , 208 - 230 V, 60 Hz	
Capacity Rated (Min. - Max.)		Btu/h	9,000 (4,400 - 10,900)	10,900 (4,400 - 16,000)	10,600 (4,400 - 13,300)	13,400 (4,400 - 18,800)
Running Current (Rated)		A	4.09 - 3.70	4.19 - 3.79	4.62 - 4.18	5.48 - 4.96
Power Consumption (Rated)		W	783 - 783	807 - 807	922 - 922	1,103 - 1,103
Power Factor (Rated)		%	92.0 - 92.1	92.6 - 92.6	95.9 - 96.0	96.8 - 96.7
SEER2 / HSPF2			19.50	10.00	19.50	10.00
EER2 (Rated)		Btu/h·W	11.50	—	11.50	—
COP2 (Rated)		W/W	—	3.96	—	3.56
Piping Connections	Liquid	in. (mm)	ϕ 1/4 (6.4)		ϕ 1/4 (6.4)	
	Gas	in. (mm)	ϕ 3/8 (9.5)		ϕ 3/8 (9.5)	
	Drain	in. (mm)	ϕ 5/8 (16)		ϕ 5/8 (16)	
Heat Insulation			Both Liquid and Gas Pipes		Both Liquid and Gas Pipes	
Max. Interunit Piping Length		ft (m)	65-5/8 (20)		65-5/8 (20)	
Max. Interunit Height Difference		ft (m)	49-1/4 (15)		49-1/4 (15)	
Chargeless		ft (m)	32-3/4 (10)		32-3/4 (10)	
Amount of Additional Charge of Refrigerant		oz/ft (g/m)	0.21 (20)		0.21 (20)	
Indoor Unit			FTX09WMVJU9		FTX12WMVJU9	
Front Panel Color			White (N9.5)		White (N9.5)	
Airflow Rate	H / M / L / SL	cfm	417 / 297 / 244 / 141	403 / 328 / 251 / 215	434 / 311 / 247 / 145	413 / 321 / 258 / 219
		m ³ /min	11.8 / 8.4 / 6.9 / 4.0	11.4 / 9.3 / 7.1 / 6.1	12.3 / 8.8 / 7.0 / 4.1	11.7 / 9.1 / 7.3 / 6.2
Fan	Type / Speed	Steps	Cross Flow Fan / 5 Steps, Quiet, Auto		Cross Flow Fan / 5 Steps, Quiet, Auto	
Air Direction Control			Right, Left, Horizontal, Downward		Right, Left, Horizontal, Downward	
Air Filter			Removable, Washable		Removable, Washable	
Running Current (Rated)		A	0.25 - 0.23	0.23 - 0.21	0.28 - 0.25	0.25 - 0.23
Power Consumption (Rated)		W	28 - 28	25 - 25	31 - 31	28 - 28
Power Factor (Rated)		%	53.8 - 52.9	52.3 - 51.8	53.2 - 53.9	53.8 - 52.9
Temperature Control			Microcomputer Control		Microcomputer Control	
Dimensions (H × W × D)		in. (mm)	11-1/4 × 30-5/16 × 8-3/4 (285 × 770 × 223)		11-1/4 × 30-5/16 × 8-3/4 (285 × 770 × 223)	
Packaged Dimensions (H × W × D)		in. (mm)	12-5/8 × 32-11/16 × 14-3/16 (320 × 830 × 360)		12-5/8 × 32-11/16 × 14-3/16 (320 × 830 × 360)	
Weight (Mass)		lbs (kg)	18 (8)		20 (9)	
Gross Weight (Gross Mass)		lbs (kg)	23 (11)		24 (11)	
Sound Pressure Level		H / M / L / SL dB(A)	43 / 36 / 30 / 19	43 / 36 / 29 / 25	45 / 37 / 30 / 19	45 / 37 / 30 / 26
Outdoor Unit			RXL09WMVJU9		RXL12WMVJU9	
Casing Color			Ivory White		Ivory White	
Heat Exchanger		Fin Spec / Tube	Waffle Fin (PE) / ϕ 7 Hi-XSL Tube		Waffle Fin (PE) / ϕ 7 Hi-XSL Tube	
Fan Motor		Motor Output HP	0.03		0.04	
Compressor		Type	Hermetically Sealed Swing Type		Hermetically Sealed Swing Type	
		Model	1YC23AUXD		2YC36PXD	
Refrigerant Oil		Type	FVC50K		FVC50K	
		Charge	oz (L)		12.68 (0.375)	
Refrigerant		Type	R-410A		R-410A	
		Charge	lbs (kg)		2.09 (0.95)	
Airflow Rate		cfm (m ³ /min)	1,105 (31.3)	922 (26.1)	1,144 (32.4)	1,031 (29.2)
Fan		Type	Propeller		Propeller	
Running Current (Rated)		A	3.84 - 3.47	3.96 - 3.58	4.34 - 3.93	5.23 - 4.73
Power Consumption (Rated)		W	755 - 755	782 - 782	891 - 891	1,075 - 1,075
Power Factor (Rated)		%	94.5 - 94.6	94.9 - 95.0	98.7 - 98.6	98.8 - 98.8
Dimensions (H × W × D)		in. (mm)	21-5/8 × 26-9/16 × 11-3/16 (550 × 675 × 284)		21-5/8 × 26-9/16 × 11-3/16 (550 × 675 × 284)	
Packaged Dimensions (H × W × D)		in. (mm)	23-13/16 × 31-7/16 × 14-11/16 (605 × 798 × 373)		23-13/16 × 31-7/16 × 14-11/16 (605 × 798 × 373)	
Weight (Mass)		lbs (kg)	63 (29)		73 (33)	
Gross Weight (Gross Mass)		lbs (kg)	68 (31)		78 (35)	
Sound Pressure Level		dB(A)	49	49	50	50
Conditions Based on		Indoor	80.0°FDB (26.7°CDB) / 67.0°FWB (19.4°CWB) / 70.0°FDB (21.1°CDB) / 60.0°FWB (15.6°CWB)		80.0°FDB (26.7°CDB) / 67.0°FWB (19.4°CWB) / 70.0°FDB (21.1°CDB) / 60.0°FWB (15.6°CWB)	
		Outdoor	95.0°FDB (35.0°CDB) / 75.0°FWB (24.0°CWB) / 47.0°FDB (8.3°CDB) / 43.0°FWB (6.1°CWB)		95.0°FDB (35.0°CDB) / 75.0°FWB (24.0°CWB) / 47.0°FDB (8.3°CDB) / 43.0°FWB (6.1°CWB)	
		Piping Length	25 ft (7.5 m)		25 ft (7.5 m)	
Drawing No.			3D143446		3D143446	
Note(s)			SL: The quiet fan level of the airflow rate setting.			

Conversion Formulae	
kcal/h = kW × 860	
Btu/h = kW × 3412	
cfm = m ³ /min × 35.3	

Model	Indoor Unit		FTX15WMVJU9		FTX18WVJU9	
	Outdoor Unit		RXL15WMVJU9		RXL18WMVJU9	
			Cooling	Heating	Cooling	Heating
Power Supply			1 ϕ , 208 - 230 V, 60 Hz		1 ϕ , 208 - 230 V, 60 Hz	
Capacity Rated (Min. - Max.)	Btu/h		15,000 (5,800 - 18,400)	18,300 (5,800 - 24,600)	18,000 (9,000 - 21,600)	21,600 (9,000 - 28,000)
Running Current (Rated)	A		6.42 - 5.81	7.24 - 6.55	7.84 - 7.09	9.62 - 8.70
Power Consumption (Rated)	W		1,250 - 1,250	1,426 - 1,426	1,565 - 1,565	1,942 - 1,942
Power Factor (Rated)	%		93.6 - 93.5	94.7 - 94.6	96.0 - 96.0	97.1 - 97.0
SEER2 / HSPF2			19.50	10.00	19.80	8.50
EER2 (Rated)	Btu/h-W		12.00	—	11.50	—
COP2 (Rated)	W/W		—	3.76	—	3.26
Piping Connections	Liquid	in. (mm)	ϕ 1/4 (6.4)		ϕ 1/4 (6.4)	
	Gas	in. (mm)	ϕ 1/2 (12.7)		ϕ 1/2 (12.7)	
	Drain	in. (mm)	ϕ 5/8 (16)		ϕ 5/8 (16)	
Heat Insulation			Both Liquid and Gas Pipes		Both Liquid and Gas Pipes	
Max. Interunit Piping Length	ft (m)		98-1/2 (30)		98-1/2 (30)	
Max. Interunit Height Difference	ft (m)		65-5/8 (20)		65-5/8 (20)	
Chargeless	ft (m)		32-3/4 (10)		32-3/4 (10)	
Amount of Additional Charge of Refrigerant	oz/ft (g/m)		0.21 (20)		0.32 (30)	
Indoor Unit			FTX15WMVJU9		FTX18WVJU9	
Front Panel Color			White (N9.5)		White (N9.5)	
Airflow Rate	H / M / L / SL	cfm	593 / 505 / 431 / 367	653 / 554 / 470 / 399	583 / 484 / 385 / 360	713 / 583 / 431 / 399
		m ³ /min	16.8 / 14.3 / 12.2 / 10.4	18.5 / 15.7 / 13.3 / 11.3	16.5 / 13.7 / 10.9 / 10.2	20.2 / 16.5 / 12.2 / 11.3
Fan	Type / Speed	Steps	Cross Flow Fan / 5 Steps, Quiet, Auto		Cross Flow Fan / 5 Steps, Quiet, Auto	
Air Direction Control			Right, Left, Horizontal, Downward		Right, Left, Horizontal, Downward	
Air Filter			Removable, Washable		Removable, Washable	
Running Current (Rated)	A		0.23 - 0.21	0.25 - 0.23	0.40 - 0.37	0.51 - 0.48
Power Consumption (Rated)	W		33 - 33	38 - 38	47 - 47	61 - 61
Power Factor (Rated)	%		69.0 - 68.3	73.1 - 71.8	57.1 - 55.1	57.1 - 55.1
Temperature Control			Microcomputer Control		Microcomputer Control	
Dimensions (H x W x D)	in. (mm)		11-5/8 x 39 x 10-3/8 (295 x 990 x 263)		13-3/8 x 41-5/16 x 10-3/16 (340 x 1,050 x 259)	
Packaged Dimensions (H x W x D)	in. (mm)		15-3/16 x 43-3/8 x 15-5/16 (386 x 1,102 x 389)		13-7/16 x 45-11/16 x 16-7/8 (342 x 1,160 x 429)	
Weight (Mass)	lbs (kg)		27 (13)		33 (15)	
Gross Weight (Gross Mass)	lbs (kg)		36 (17)		42 (19)	
Sound Pressure Level	H / M / L / SL	dB(A)	45 / 41 / 36 / 33	45 / 41 / 37 / 33	46 / 41 / 36 / 33	48 / 42 / 35 / 32
Outdoor Unit			RXL15WMVJU9		RXL18WMVJU9	
Casing Color			Ivory White		Ivory White	
Heat Exchanger	Fin Spec / Tube		Waffle Fin (PE) / ϕ 7 Hi-XSL Tube		Waffle Fin (PE) / ϕ 7 Hi-XSL Tube	
Fan Motor	Motor Output	HP	0.12		0.16	
Compressor	Type		Hermetically Sealed Swing Type		Hermetically Sealed Swing Type	
	Model		2YC36PXD		2YC63AAXD	
Refrigerant Oil	Type		FVC50K		FVC50K	
	Charge	oz (L)	21.98 (0.650)		30.43 (0.900)	
Refrigerant	Type		R-410A		R-410A	
	Charge	lbs (kg)	3.20 (1.45)		3.53 (1.60)	
Airflow Rate	cfm (m ³ /min)		2,044 (57.9)	2,044 (57.9)	2,419 (68.5)	2,362 (66.9)
Fan	Type		Propeller		Propeller	
Running Current (Rated)	A		6.19 - 5.60	6.99 - 6.32	7.44 - 6.72	9.11 - 8.22
Power Consumption (Rated)	W		1,217 - 1,217	1,388 - 1,388	1,518 - 1,518	1,881 - 1,881
Power Factor (Rated)	%		94.5 - 94.5	95.5 - 95.5	98.1 - 98.2	99.3 - 99.5
Dimensions (H x W x D)	in. (mm)		28-15/16 x 34-1/4 x 12-5/8 (735 x 870 x 320)		28-15/16 x 34-1/4 x 12-5/8 (735 x 870 x 320)	
Packaged Dimensions (H x W x D)	in. (mm)		31-7/8 x 41-9/16 x 18-1/4 (810 x 1,056 x 464)		31-7/8 x 41-9/16 x 18-1/4 (810 x 1,056 x 464)	
Weight (Mass)	lbs (kg)		109 (50)		132 (60)	
Gross Weight (Gross Mass)	lbs (kg)		119 (54)		142 (65)	
Sound Pressure Level	dB(A)		50	55	54	55
Conditions Based on	Indoor		80.0°FDB (26.7°CDB) / 67.0°FWB (19.4°CWB)	70.0°FDB (21.1°CDB) / 60.0°FWB (15.6°CWB)	80.0°FDB (26.7°CDB) / 67.0°FWB (19.4°CWB)	70.0°FDB (21.1°CDB) / 60.0°FWB (15.6°CWB)
	Outdoor		95.0°FDB (35.0°CDB) / 75.0°FWB (24.0°CWB)	47.0°FDB (8.3°CDB) / 43.0°FWB (6.1°CWB)	95.0°FDB (35.0°CDB) / 75.0°FWB (24.0°CWB)	47.0°FDB (8.3°CDB) / 43.0°FWB (6.1°CWB)
	Piping Length		25 ft (7.5 m)		25 ft (7.5 m)	
Drawing No.			3D143446		3D143445A	
Note(s)			SL: The quiet fan level of the airflow rate setting.			

Conversion Formulae	
kcal/h = kW x 860	
Btu/h = kW x 3412	
cfm = m ³ /min x 35.3	

Model	Indoor Unit		FTX24WVJU9	
	Outdoor Unit		Cooling	Heating
Power Supply		1 ϕ , 208 - 230 V, 60 Hz		
Capacity Rated (Min. - Max.)	Btu/h	21,200 (9,000 - 25,800)		24,000 (9,000 - 32,000)
Running Current (Rated)	A	9.23 - 8.35		11.39 - 10.30
Power Consumption (Rated)	W	1,843 - 1,843		2,299 - 2,299
Power Factor (Rated)	%	96.0 - 96.0		97.0 - 97.0
SEER2 / HSPF2		19.50		8.50
EER2 (Rated)	Btu/h·W	11.50		—
COP2 (Rated)	W/W	—		3.06
Piping Connections	Liquid	in. (mm)	ϕ 1/4 (6.4)	
	Gas	in. (mm)	ϕ 5/8 (15.9)	
	Drain	in. (mm)	ϕ 5/8 (16)	
Heat Insulation		Both Liquid and Gas Pipes		
Max. Interunit Piping Length	ft (m)	98-1/2 (30)		
Max. Interunit Height Difference	ft (m)	65-5/8 (20)		
Chargeless	ft (m)	32-3/4 (10)		
Amount of Additional Charge of Refrigerant	oz/ft (g/m)	0.32 (30)		
Indoor Unit		FTX24WVJU9		
Front Panel Color		White (N9.5)		
Airflow Rate	H / M / L / SL	cfm	643 / 494 / 350 / 328	
		m ³ /min	18.2 / 14.0 / 9.9 / 9.3	
Fan	Type / Speed	Steps	Cross Flow Fan / 5 Steps, Quiet, Auto	
Air Direction Control		Right, Left, Horizontal, Downward		
Air Filter		Removable, Washable		
Running Current (Rated)	A	0.64 - 0.58		0.63 - 0.57
Power Consumption (Rated)	W	78 - 78		76 - 76
Power Factor (Rated)	%	58.2 - 58.0		58.2 - 58.0
Temperature Control		Microcomputer Control		
Dimensions (H x W x D)	in. (mm)	13-3/8 x 41-5/16 x 10-3/16 (340 x 1,050 x 259)		
Packaged Dimensions (H x W x D)	in. (mm)	13-7/16 x 45-11/16 x 16-7/8 (342 x 1,160 x 429)		
Weight (Mass)	lbs (kg)	33 (15)		
Gross Weight (Gross Mass)	lbs (kg)	44 (20)		
Sound Pressure Level	H / M / L / SL	dB(A)		51 / 44 / 37 / 34
Outdoor Unit		RXL24WMVJU9		
Casing Color		Ivory White		
Heat Exchanger	Fin Spec / Tube	Waffle Fin (PE) / ϕ 7 Hi-XSL Tube		
Fan Motor	Motor Output	HP	0.16	
Compressor	Type	Hermetically Sealed Swing Type		
	Model	2YC63AAXD		
Refrigerant Oil	Type	FVC50K		
	Charge	oz (L)	30.43 (0.900)	
Refrigerant	Type	R-410A		
	Charge	lbs (kg)	3.53 (1.60)	
Airflow Rate		cfm (m ³ /min)	2,419 (68.5)	
Fan	Type	Propeller		
Running Current (Rated)	A	8.59 - 7.77		10.76 - 9.73
Power Consumption (Rated)	W	1,765 - 1,765		2,223 - 2,223
Power Factor (Rated)	%	98.8 - 98.8		99.3 - 99.3
Dimensions (H x W x D)	in. (mm)	28-15/16 x 34-1/4 x 12-5/8 (735 x 870 x 320)		
Packaged Dimensions (H x W x D)	in. (mm)	31-7/8 x 41-9/16 x 18-1/4 (810 x 1,056 x 464)		
Weight (Mass)	lbs (kg)	132 (60)		
Gross Weight (Gross Mass)	lbs (kg)	142 (65)		
Sound Pressure Level		55		55
Conditions Based on	Indoor	80.0°FDB (26.7°CDB) / 67.0°FWB (19.4°CWB)		70.0°FDB (21.1°CDB) / 60.0°FWB (15.6°CWB)
	Outdoor	95.0°FDB (35.0°CDB) / 75.0°FWB (24.0°CWB)		47.0°FDB (8.3°CDB) / 43.0°FWB (6.1°CWB)
	Piping Length	25 ft (7.5 m)		
Drawing No.	3D143445A			
Note(s)	SL: The quiet fan level of the airflow rate setting.			

Conversion Formulae
kcal/h = kW x 860
Btu/h = kW x 3412
cfm = m ³ /min x 35.3

1.2 Floor Standing Type

Model	Indoor Unit		FVXS09WVJU9		FVXS12WVJU9	
	Outdoor Unit		RXL09WMVJU9		RXL12WMVJU9	
			Cooling	Heating	Cooling	Heating
Power Supply			1 ϕ , 208 - 230 V, 60 Hz		1 ϕ , 208 - 230 V, 60 Hz	
Capacity Rated (Min. - Max.)		Btu/h	9,000 (4,400 - 10,200)	10,100 (4,400 - 14,300)	10,200 (4,400 - 12,300)	13,000 (4,400 - 17,100)
Running Current (Rated)		A	4.08 - 3.69	3.91 - 3.54	4.58 - 4.14	5.00 - 4.52
Power Consumption (Rated)		W	783 - 783	767 - 767	927 - 927	1,013 - 1,013
Power Factor (Rated)		%	92.3 - 92.3	94.3 - 94.3	97.3 - 97.3	97.4 - 97.4
SEER2 / HSPF2			19.50	9.70	19.50	9.40
EER2 (Rated)		Btu/h·W	11.50	—	11.00	—
COP2 (Rated)		W/W	—	3.86	—	3.76
Piping Connections	Liquid	in. (mm)	ϕ 1/4 (6.4)		ϕ 1/4 (6.4)	
	Gas	in. (mm)	ϕ 3/8 (9.5)		ϕ 3/8 (9.5)	
	Drain	in. (mm)	ϕ 13/16 (20)		ϕ 13/16 (20)	
Heat Insulation			Both Liquid and Gas Pipes		Both Liquid and Gas Pipes	
Max. Interunit Piping Length		ft (m)	65-5/8 (20)		65-5/8 (20)	
Max. Interunit Height Difference		ft (m)	49-1/4 (15)		49-1/4 (15)	
Chargeless		ft (m)	32-3/4 (10)		32-3/4 (10)	
Amount of Additional Charge of Refrigerant		oz/ft (g/m)	0.21 (20)		0.21 (20)	
Indoor Unit			FVXS09WVJU9		FVXS12WVJU9	
Front Panel Color			White (B-272)		White (B-272)	
Airflow Rate	H / M / L / SL	cfm	290 / 230 / 169 / 145	311 / 244 / 177 / 155	300 / 237 / 173 / 159	332 / 258 / 184 / 166
		m ³ /min	8.2 / 6.5 / 4.8 / 4.1	8.8 / 6.9 / 5.0 / 4.4	8.5 / 6.7 / 4.9 / 4.5	9.4 / 7.3 / 5.2 / 4.7
Fan	Type / Speed	Steps	Turbo Fan / 5 Steps, Quiet, Auto		Turbo Fan / 5 Steps, Quiet, Auto	
Air Direction Control			Right, Left, Horizontal, Downward		Right, Left, Horizontal, Downward	
Air Filter			Removable, Washable, Mildew Proof		Removable, Washable, Mildew Proof	
Running Current (Rated)		A	0.14 - 0.13	0.15 - 0.14	0.14 - 0.13	0.15 - 0.14
Power Consumption (Rated)		W	15 - 15	17 - 17	15 - 15	17 - 17
Power Factor (Rated)		%	51.5 - 50.2	54.5 - 52.8	51.5 - 50.2	54.5 - 52.8
Temperature Control			Microcomputer Control		Microcomputer Control	
Dimensions (H × W × D)		in. (mm)	23-5/8 × 27-9/16 × 8-1/4 (600 × 700 × 210)		23-5/8 × 27-9/16 × 8-1/4 (600 × 700 × 210)	
Packaged Dimensions (H × W × D)		in. (mm)	27-3/8 × 30-15/16 × 11 (696 × 786 × 280)		27-3/8 × 30-15/16 × 11 (696 × 786 × 280)	
Weight (Mass)		lbs (kg)	31 (14)		31 (14)	
Gross Weight (Gross Mass)		lbs (kg)	38 (17)		38 (17)	
Sound Pressure Level		H / M / L / SL dB(A)	38 / 32 / 26 / 23	38 / 32 / 26 / 23	39 / 33 / 27 / 24	39 / 33 / 27 / 24
Outdoor Unit			RXL09WMVJU9		RXL12WMVJU9	
Casing Color			Ivory White		Ivory White	
Heat Exchanger		Fin Spec / Tube	Waffle Fin (PE) / ϕ 7 Hi-XSL Tube		Waffle Fin (PE) / ϕ 7 Hi-XSL Tube	
Fan Motor		Motor Output HP	0.03		0.04	
Compressor		Type	Hermetically Sealed Swing Type		Hermetically Sealed Swing Type	
		Model	1YC23AUXD		2YC36PXD	
Refrigerant Oil		Type	FVC50K		FVC50K	
		Charge	oz (L)		12.68 (0.380)	
Refrigerant		Type	R-410A		R-410A	
		Charge	lbs (kg)		2.09 (0.95)	
Airflow Rate		cfm (m ³ /min)	1,105 (31.3)	922 (26.1)	1,144 (32.4)	1,031 (29.2)
Fan		Type	Propeller		Propeller	
Running Current (Rated)		A	3.94 - 3.56	3.76 - 3.40	4.44 - 4.01	4.85 - 4.38
Power Consumption (Rated)		W	768 - 768	750 - 750	912 - 912	996 - 996
Power Factor (Rated)		%	93.7 - 93.8	95.9 - 95.9	98.8 - 98.9	98.7 - 98.9
Dimensions (H × W × D)		in. (mm)	21-5/8 × 26-9/16 × 11-3/16 (550 × 675 × 284)		21-5/8 × 26-9/16 × 11-3/16 (550 × 675 × 284)	
Packaged Dimensions (H × W × D)		in. (mm)	23-13/16 × 31-7/16 × 14-11/16 (605 × 798 × 373)		23-13/16 × 31-7/16 × 14-11/16 (605 × 798 × 373)	
Weight (Mass)		lbs (kg)	63 (29)		73 (33)	
Gross Weight (Gross Mass)		lbs (kg)	68 (31)		78 (35)	
Sound Pressure Level		dB(A)	49	49	50	50
Conditions Based on		Indoor	80.0°FDB (26.7°CDB) / 67.0°FWB (19.4°CWB)	70.0°FDB (21.1°CDB) / 60.0°FWB (15.6°CWB)	80.0°FDB (26.7°CDB) / 67.0°FWB (19.4°CWB)	70.0°FDB (21.1°CDB) / 60.0°FWB (15.6°CWB)
		Outdoor	95.0°FDB (35.0°CDB) / 75.0°FWB (24.0°CWB)	47.0°FDB (8.3°CDB) / 43.0°FWB (6.1°CWB)	95.0°FDB (35.0°CDB) / 75.0°FWB (24.0°CWB)	47.0°FDB (8.3°CDB) / 43.0°FWB (6.1°CWB)
Piping Length			25 ft (7.5 m)		25 ft (7.5 m)	
Drawing No.			3D143142A		3D143142A	
Note(s)			SL: The quiet fan level of the airflow rate setting.			

Conversion Formulae	
kcal/h = kW × 860	
Btu/h = kW × 3412	
cfm = m ³ /min × 35.3	

Model	Indoor Unit		FVXS15WVJU9	
	Outdoor Unit		RXL15WVJU9	
		Cooling		Heating
Power Supply		1 ϕ, 208 - 230 V, 60 Hz		
Capacity Rated (Min. - Max.)	Btu/h	15,000 (5,800 - 17,100)		18,000 (5,800 - 24,000)
Running Current (Rated)	A	6.59 - 5.96		7.49 - 6.77
Power Consumption (Rated)	W	1,304 - 1,304		1,499 - 1,499
Power Factor (Rated)	%	95.1 - 95.2		96.2 - 96.2
SEER2 / HSPF2		19.50		9.30
EER2 (Rated)	Btu/h·W	11.50		—
COP2 (Rated)	W/W	—		3.52
Piping Connections	Liquid	in. (mm)	ϕ 1/4 (6.4)	
	Gas	in. (mm)	ϕ 1/2 (12.7)	
	Drain	in. (mm)	ϕ 13/16 (20)	
Heat Insulation		Both Liquid and Gas Pipes		
Max. Interunit Piping Length	ft (m)	98-1/2 (30)		
Max. Interunit Height Difference	ft (m)	65-5/8 (20)		
Chargeless	ft (m)	32-3/4 (10)		
Amount of Additional Charge of Refrigerant	oz/ft (g/m)	0.21 (20)		
Indoor Unit		FVXS15WVJU9		
Front Panel Color		White (B-272)		
Airflow Rate	H / M / L / SL	cfm	378 / 325 / 275 / 233	
		m³/min	10.7 / 9.2 / 7.8 / 6.6	
Fan	Type / Speed	Steps	Turbo Fan / 5 Steps, Quiet, Auto	
Air Direction Control		Right, Left, Horizontal, Downward		
Air Filter		Removable, Washable, Mildew Proof		
Running Current (Rated)	A	0.19 - 0.17		0.21 - 0.19
Power Consumption (Rated)	W	27 - 27		34 - 34
Power Factor (Rated)	%	68.3 - 69.1		77.8 - 77.8
Temperature Control		Microcomputer Control		
Dimensions (H × W × D)	in. (mm)	23-5/8 × 27-9/16 × 8-1/4 (600 × 700 × 210)		
Packaged Dimensions (H × W × D)	in. (mm)	27-3/8 × 30-15/16 × 11 (696 × 786 × 280)		
Weight (Mass)	lbs (kg)	31 (14)		
Gross Weight (Gross Mass)	lbs (kg)	38 (17)		
Sound Pressure Level	H / M / L / SL	dB(A)	44 / 40 / 36 / 32	
Outdoor Unit		RXL15WVJU9		
Casing Color		Ivory White		
Heat Exchanger	Fin Spec / Tube	Waffle Fin (PE) / ϕ 7 Hi-XSL Tube		
Fan Motor	Motor Output	HP	0.12	
Compressor	Type	Hermetically Sealed Swing Type		
	Model	2YC36PXD		
Refrigerant Oil	Type	FVC50K		
	Charge	oz (L)	21.98 (0.650)	
Refrigerant	Type	R-410A		
	Charge	lbs (kg)	3.20 (1.45)	
Airflow Rate		cfm (m³/min)	2,044 (57.9)	
Fan	Type	Propeller		
Running Current (Rated)	A	6.40 - 5.79		7.28 - 6.58
Power Consumption (Rated)	W	1,277 - 1,277		1,465 - 1,465
Power Factor (Rated)	%	95.9 - 95.9		96.7 - 96.8
Dimensions (H × W × D)	in. (mm)	28-15/16 × 34-1/4 × 12-5/8 (735 × 870 × 320)		
Packaged Dimensions (H × W × D)	in. (mm)	31-7/8 × 41-9/16 × 18-1/4 (810 × 1,056 × 464)		
Weight (Mass)	lbs (kg)	109 (50)		
Gross Weight (Gross Mass)	lbs (kg)	119 (54)		
Sound Pressure Level		dB(A)	50	
Conditions Based on	Indoor	80.0°FDB (26.7°CDB) / 67.0°FWB (19.4°CWB)		70.0°FDB (21.1°CDB) / 60.0°FWB (15.6°CWB)
	Outdoor	95.0°FDB (35.0°CDB) / 75.0°FWB (24.0°CWB)		47.0°FDB (8.3°CDB) / 43.0°FWB (6.1°CWB)
	Piping Length	25 ft (7.5 m)		
Drawing No.	3D143142A			
Note(s)	SL: The quiet fan level of the airflow rate setting.			

Conversion Formulae
kcal/h = kW × 860
Btu/h = kW × 3412
cfm = m³/min × 35.3

1.3 Duct Concealed Type

Model	Indoor Unit		FDMQ12WVJU9		FDMQ18WVJU9	
	Outdoor Unit		RXL12WVJU9		RXL18WVJU9	
			Cooling	Heating	Cooling	Heating
Power Supply			1 ϕ, 208 - 230 V, 60 Hz		1 ϕ, 208 - 230 V, 60 Hz	
Capacity Rated (Min. - Max.)	Btu/h		10,800 (6,500 - 12,400)	12,500 (6,300 - 17,000)	17,600 (9,000 - 19,600)	21,600 (9,000 - 25,000)
Running Current (Rated)	A		5.90 - 5.34	5.93 - 5.36	8.79 - 7.95	10.50 - 9.50
Power Consumption (Rated)	W		1,213 - 1,213	1,221 - 1,221	1,760 - 1,760	2,110 - 2,110
Power Factor (Rated)	%		98.8 - 98.8	99.0 - 99.0	96.3 - 96.2	96.6 - 96.6
SEER2 / HSPF2			14.60	8.90	15.20	8.50
EER2 (Rated)	Btu/h·W		8.90	—	10.00	—
COP2 (Rated)	W/W		—	3.00	—	3.00
Piping Connections	Liquid	in. (mm)	ϕ 1/4 (6.4)		ϕ 1/4 (6.4)	
	Gas	in. (mm)	ϕ 3/8 (9.5)		ϕ 1/2 (12.7)	
	Drain	in. (mm)	I.D. ϕ 1 (25) / O.D. ϕ 1-1/4 (32)		I.D. ϕ 1 (25) / O.D. ϕ 1-1/4 (32)	
Heat Insulation			Both Liquid and Gas Pipes		Both Liquid and Gas Pipes	
Max. Interunit Piping Length	ft (m)		65-5/8 (20)		98-1/2 (30)	
Max. Interunit Height Difference	ft (m)		49-1/4 (15)		65-5/8 (20)	
Chargeless	ft (m)		32-3/4 (10)		32-3/4 (10)	
Amount of Additional Charge of Refrigerant	oz/ft (g/m)		0.21 (20)		0.32 (30)	
Indoor Unit			FDMQ12WVJU9		FDMQ18WVJU9	
Heat Exchanger	Rows × Stages, Fin per Inch		3 × 26, 18		3 × 26, 18	
	Fin Spec / Tube		Multi Slit Fin / ϕ 5 Hi-XA Tube		Multi Slit Fin / ϕ 5 Hi-XA Tube	
Airflow Rate	H / M / L	cfm	371 / 318 / 261	371 / 318 / 261	614 / 523 / 431	614 / 523 / 431
		m ³ /min	10.5 / 9.0 / 7.4	10.5 / 9.0 / 7.4	17.4 / 14.8 / 12.2	17.4 / 14.8 / 12.2
Fan Motor	H / M / L	rpm	1,089 / 930 / 771	1,089 / 930 / 771	1,023 / 870 / 717	1,023 / 870 / 717
	Motor Output	HP	0.17		0.31	
Fan	Type		Sirotco Fan		Sirotco Fan	
External Static Pressure		inH ₂ O	Standard 0.20 (0.60 - 0.12)		Standard 0.20 (0.60 - 0.20)	
		Pa	Standard 50 (150 - 30)		Standard 50 (150 - 50)	
Running Current (Rated)	A		0.44 - 0.40	0.44 - 0.40	0.69 - 0.62	0.69 - 0.62
Power Consumption (Rated)	W		89 - 89	89 - 89	131 - 131	131 - 131
Power Factor (Rated)	%		97.0 - 97.6	97.0 - 97.6	91.2 - 92.2	91.2 - 92.2
Temperature Control			Microcomputer Control		Microcomputer Control	
Dimensions (H × W × D)	in. (mm)		9-5/8 × 27-9/16 × 31-1/2 (245 × 700 × 800)		9-5/8 × 39-3/8 × 31-1/2 (245 × 1,000 × 800)	
Packaged Dimensions (H × W × D)	in. (mm)		11-9/16 × 35-3/8 × 34-7/8 (293 × 899 × 886)		11-9/16 × 47-3/16 × 34-7/8 (293 × 1,199 × 886)	
Weight (Mass)	lbs (kg)		64 (29)		82 (37)	
Gross Weight (Gross Mass)	lbs (kg)		71 (32)		88 (40)	
Sound Pressure Level	dB(A)		33	33	35	35
Remote Controller (Option)	Wired		BRC1E73		BRC1E73	
	Wireless		BRC082A43		BRC082A43	
Outdoor Unit			RXL12WVJU9		RXL18WVJU9	
Casing Color			Ivory White		Ivory White	
Heat Exchanger	Fin Spec / Tube		Waffle Fin (PE) / ϕ 7 Hi-XSL Tube		Waffle Fin (PE) / ϕ 7 Hi-XSL Tube	
Fan Motor	Motor Output	HP	0.04		0.16	
Compressor	Type		Hermetically Sealed Swing Type		Hermetically Sealed Swing Type	
	Model		2YC36PXD		2YC63AAXD	
Refrigerant Oil	Type		FVC50K		FVC50K	
	Charge	oz (L)	21.98 (0.650)		30.43 (0.900)	
Refrigerant	Type		R-410A		R-410A	
	Charge	lbs (kg)	2.09 (0.95)		3.53 (1.60)	
Airflow Rate	cfm (m ³ /min)		1,144 (32.4)	1,031 (29.2)	2,419 (68.5)	2,362 (66.9)
Fan	Type		Propeller		Propeller	
Running Current (Rated)	A		5.46 - 4.94	5.49 - 4.96	8.10 - 7.33	9.81 - 8.88
Power Consumption (Rated)	W		1,124 - 1,124	1,132 - 1,132	1,629 - 1,629	1,979 - 1,979
Power Factor (Rated)	%		99.0 - 98.9	99.1 - 99.2	96.7 - 96.6	97.0 - 96.9
Dimensions (H × W × D)	in. (mm)		21-5/8 × 26-9/16 × 11-3/16 (550 × 675 × 284)		28-15/16 × 34-1/4 × 12-5/8 (735 × 870 × 320)	
Packaged Dimensions (H × W × D)	in. (mm)		23-13/16 × 31-7/16 × 14-11/16 (605 × 798 × 373)		31-7/8 × 41-9/16 × 18-1/4 (810 × 1,056 × 464)	
Weight (Mass)	lbs (kg)		73 (33)		132 (60)	
Gross Weight (Gross Mass)	lbs (kg)		78 (35)		142 (65)	
Sound Pressure Level	dB(A)		50	50	54	55
Conditions Based on	Indoor		80.0°FDB (26.7°CDB) / 67.0°FWB (19.4°CWB)		80.0°FDB (26.7°CDB) / 67.0°FWB (19.4°CWB)	
	Outdoor		70.0°FDB (21.1°CDB) / 60.0°FWB (15.6°CWB)		70.0°FDB (21.1°CDB) / 60.0°FWB (15.6°CWB)	
	Piping Length		25 ft (7.5 m)		25 ft (7.5 m)	
Drawing No.			C: 3D143347		3D143347	
Note(s)			SL: The quiet fan level of the airflow rate setting. External static pressure is changeable in 13 (FDMQ12WVJU9), 11 (FDMQ18WVJU9) stages by remote controller. Air filter is not standard accessory, but please mount it in the duct system of the suction side. Select its dust collection efficiency (gravity method) 50% or more.			

Conversion Formulae	
kcal/h = kW × 860	
Btu/h = kW × 3412	
cfm = m ³ /min × 35.3	

Model	Indoor Unit		FDMQ24WVJU9	
	Outdoor Unit		RXL24WVJU9	
		Cooling	Heating	
Power Supply		1 ϕ , 208 - 230 V, 60 Hz		
Capacity Rated (Min. - Max.)	Btu/h	21,200 (9,000 - 23,000)		24,000 (9,000 - 27,600)
Running Current (Rated)	A	10.74 - 9.71		11.41 - 10.32
Power Consumption (Rated)	W	2,208 - 2,208		2,345 - 2,345
Power Factor (Rated)	%	98.8 - 98.9		98.8 - 98.8
SEER2 / HSPF2		15.20		8.40
EER2 (Rated)	Btu/h·W	9.60		—
COP2 (Rated)	W/W	—		3.00
Piping Connections	Liquid	in. (mm)	ϕ 1/4 (6.4)	
	Gas	in. (mm)	ϕ 5/8 (15.9)	
	Drain	in. (mm)	I.D. ϕ 1 (25) / O.D. ϕ 1-1/4 (32)	
Heat Insulation		Both Liquid and Gas Pipes		
Max. Interunit Piping Length	ft (m)	98-1/2 (30)		
Max. Interunit Height Difference	ft (m)	65-5/8 (20)		
Chargeless	ft (m)	32-3/4 (10)		
Amount of Additional Charge of Refrigerant	oz/ft (g/m)	0.32 (30)		
Indoor Unit		FDMQ24WVJU9		
Heat Exchanger	Rows \times Stages, Fin per Inch	3 \times 26, 18		
	Fin Spec / Tube	Multi Slit Fin / ϕ 5 Hi-XA Tube		
Airflow Rate	H / M / L	cfm	731 / 621 / 512	731 / 621 / 512
		m ³ /min	20.7 / 17.6 / 14.5	20.7 / 17.6 / 14.5
Fan Motor	H / M / L	rpm	1,119 / 951 / 783	1,119 / 951 / 783
Fan	Motor Output	HP	0.31	
	Type	Sirocco Fan		
External Static Pressure	inH ₂ O	Standard 0.20 (0.60 - 0.20)		
	Pa	Standard 50 (150 - 50)		
Running Current (Rated)	A	0.82 - 0.74		0.82 - 0.74
Power Consumption (Rated)	W	167 - 167		167 - 167
Power Factor (Rated)	%	97.8 - 97.5		97.8 - 97.5
Temperature Control		Microcomputer Control		
Dimensions (H \times W \times D)	in. (mm)	9-5/8 \times 39-3/8 \times 31-1/2 (245 \times 1,000 \times 800)		
Packaged Dimensions (H \times W \times D)	in. (mm)	11-9/16 \times 47-3/16 \times 34-7/8 (293 \times 1,199 \times 886)		
Weight (Mass)	lbs (kg)	82 (37)		
Gross Weight (Gross Mass)	lbs (kg)	88 (40)		
Sound Pressure Level	dB(A)	40		40
Remote Controller (Option)	Wired	BRC1E73		
	Wireless	BRC082A43		
Outdoor Unit		RXL24WVJU9		
Casing Color		Ivory White		
Heat Exchanger	Fin Spec / Tube	Waffle Fin (PE) / ϕ 7 Hi-XSL Tube		
Fan Motor	Motor Output	HP	0.16	
Compressor	Type	Hermetically Sealed Swing Type		
	Model	2YC63AAXD		
Refrigerant Oil	Type	FVC50K		
	Charge	oz (L)	30.43 (0.900)	
Refrigerant	Type	R-410A		
	Charge	lbs (kg)	3.53 (1.60)	
Airflow Rate	cfm (m ³ /min)	2,419 (68.5)		2,362 (66.9)
Fan	Type	Propeller		
Running Current (Rated)	A	9.92 - 8.97		10.59 - 9.58
Power Consumption (Rated)	W	2,041 - 2,041		2,178 - 2,178
Power Factor (Rated)	%	98.9 - 98.9		98.9 - 98.8
Dimensions (H \times W \times D)	in. (mm)	28-15/16 \times 34-1/4 \times 12-5/8 (735 \times 870 \times 320)		
Packaged Dimensions (H \times W \times D)	in. (mm)	31-7/8 \times 41-9/16 \times 18-1/4 (810 \times 1,056 \times 464)		
Weight (Mass)	lbs (kg)	132 (60)		
Gross Weight (Gross Mass)	lbs (kg)	142 (65)		
Sound Pressure Level	dB(A)	55		55
Conditions Based on	Indoor	80.0°FDB (26.7°CDB) / 67.0°FWB (19.4°CWB)		70.0°FDB (21.1°CDB) / 60.0°FWB (15.6°CWB)
	Outdoor	95.0°FDB (35.0°CDB) / 75.0°FWB (24.0°CWB)		47.0°FDB (8.3°CDB) / 43.0°FWB (6.1°CWB)
	Piping Length	25 ft (7.5 m)		
Drawing No.	3D143347			
Note(s)	SL: The quiet fan level of the airflow rate setting. External static pressure is changeable in 11 stages by remote controller. Air filter is not standard accessory, but please mount it in the duct system of the suction side. Select its dust collection efficiency (gravity method) 50% or more.			

Conversion Formulae
kcal/h = kW \times 860
Btu/h = kW \times 3412
cfm = m ³ /min \times 35.3

Part 3 Printed Circuit Board Connector Wiring Diagram

1. Indoor Unit.....	21
1.1 FTX09/12WMVJU9	21
1.2 FTX15WMVJU9	23
1.3 FTX18/24WVJU9	25
1.4 FVXS09/12/15WVJU9.....	27
1.5 FDMQ12/18/24WVJU9.....	29
2. Wired Remote Controller.....	31
2.1 BRC1E73	31
3. Wireless Remote Controller Receiver for FDMQ Series	32
3.1 BRC082A43	32
4. Outdoor Unit.....	33
4.1 RXL09WMVJU9	33
4.2 RXL12WMVJU9	35
4.3 RXL15WMVJU9	37
4.4 RXL18/24WMVJU9	38

1. Indoor Unit

1.1 FTX09/12WMVJU9

Control PCB (PCB1)

- | | |
|-------------------|---|
| 1) S6 | Connector for swing motor (horizontal blade) |
| 2) S26 | Connector for display/signal receiver PCB (PCB2) |
| 3) S32 | Connector for indoor heat exchanger thermistor (RTH2) |
| 4) S200 | Connector for DC fan motor |
| 5) S403 | Connector for optional adaptor |
| 6) H1, H2, H3, FG | Wire harness for terminal strip |
| 7) FU1 | Fuse (3.15 A, 250 V) |
| 8) V2 | Varistor |

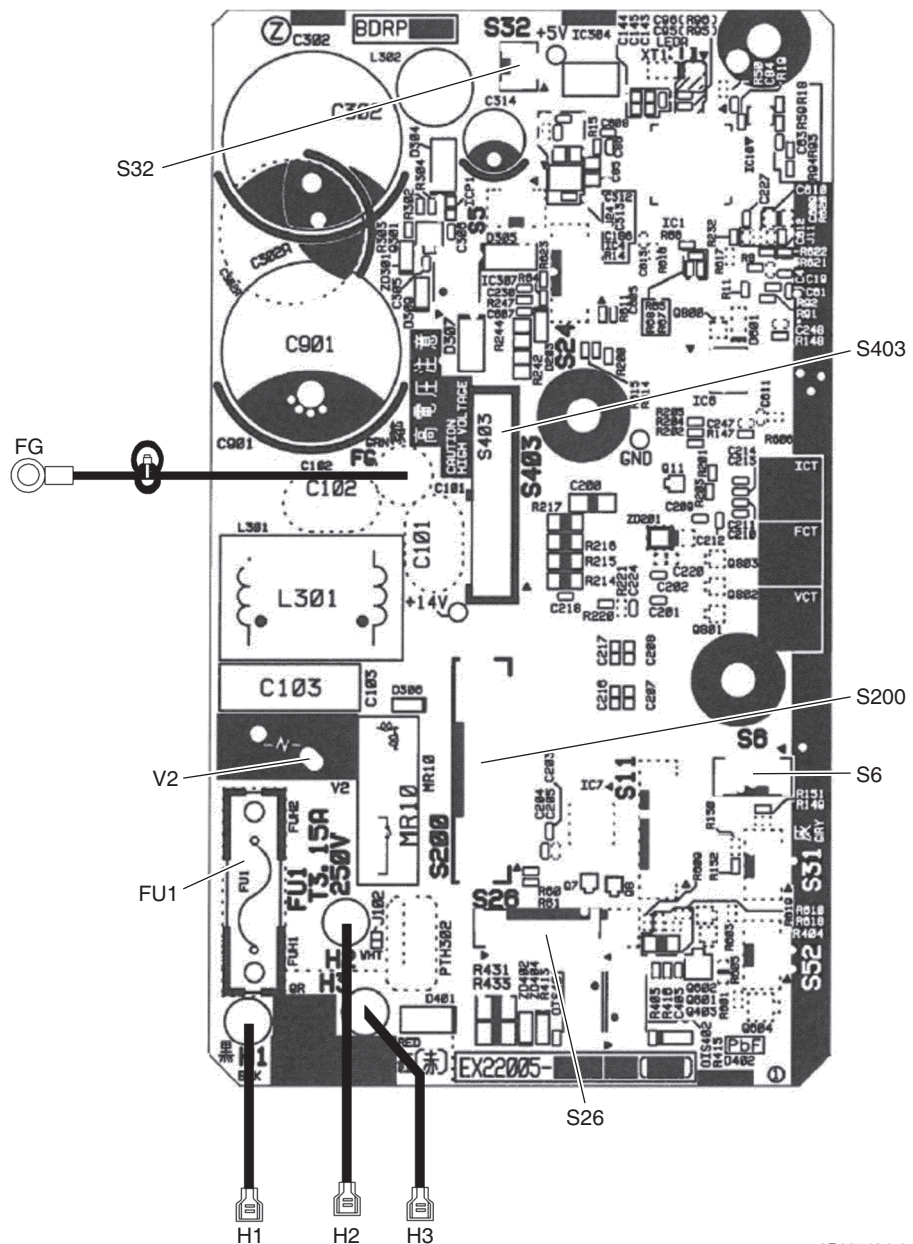

2P687404-4

Display/Signal Receiver PCB (PCB2)

- 1) S27 Connector for control PCB (PCB1)
- 2) SW1 Indoor unit **ON/OFF** switch
(Forced cooling operation **ON/OFF** switch)
Refer to page 206 for details of forced cooling operation.
- 3) LED1 LED for operation (green)
- 4) LED2 LED for timer (yellow)
- 5) RTH1 Room temperature thermistor

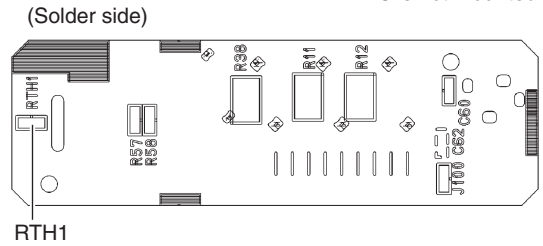
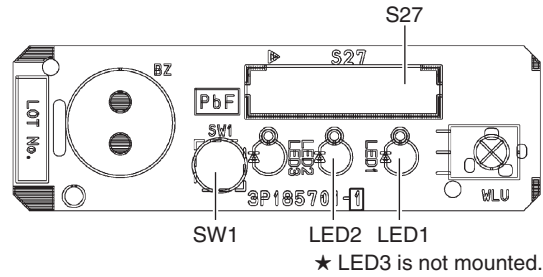

3P185701-4

1.2 FTX15WMVJU9

Control PCB (PCB2)

- 1) S6 Connector for swing motor (horizontal blade)
- 2) S26 Connector for display/signal receiver PCB (PCB3)
- 3) S32 Connector for indoor heat exchanger thermistor (R2T)
- 4) S200 Connector for DC fan motor
- 5) S403 Connector for optional adaptor
- 6) S900 Connector for filter PCB (PCB1)

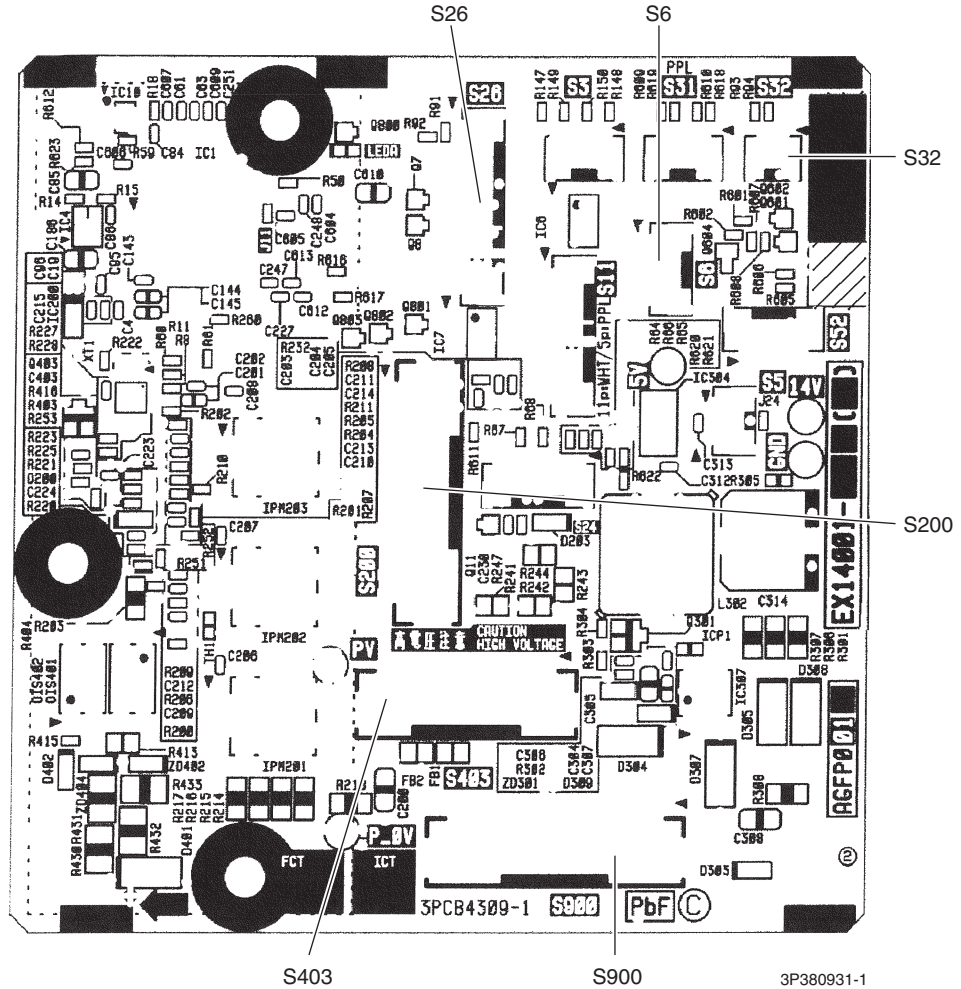

Filter PCB (PCB1)

- 1) S100 Connector for terminal strip
- 2) S800 Connector for control PCB (PCB2)
- 3) FG, HE Connector for ground
- 4) FU1 Fuse (3.15 A, 250 V)
- 5) V2 Varistor

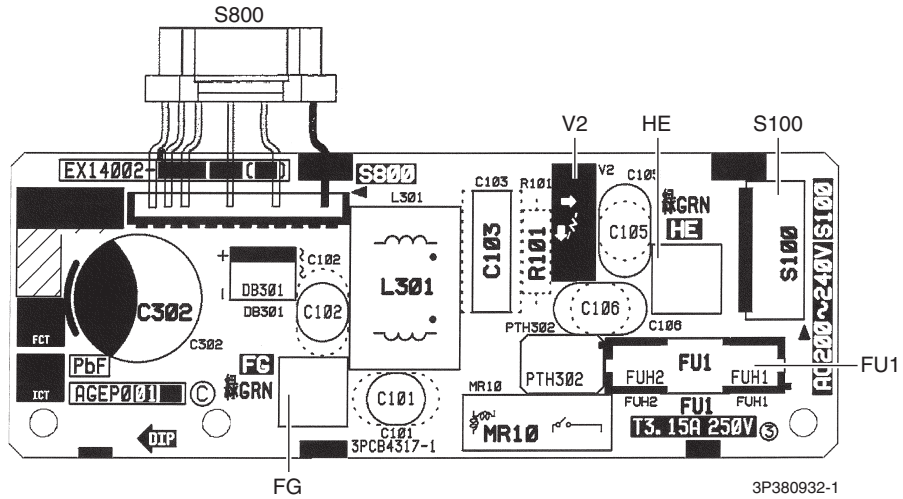

Display/Signal Receiver PCB (PCB3)

- 1) S27 Connector for control PCB (PCB2)
- 2) S1W Indoor unit **ON/OFF** switch
(Forced cooling operation **ON/OFF** switch)
Refer to page 206 for details of forced cooling operation.
- 3) LED1 (H1P) LED for operation (green)
- 4) LED2 (H2P) LED for timer (yellow)
- 5) R1T Room temperature thermistor

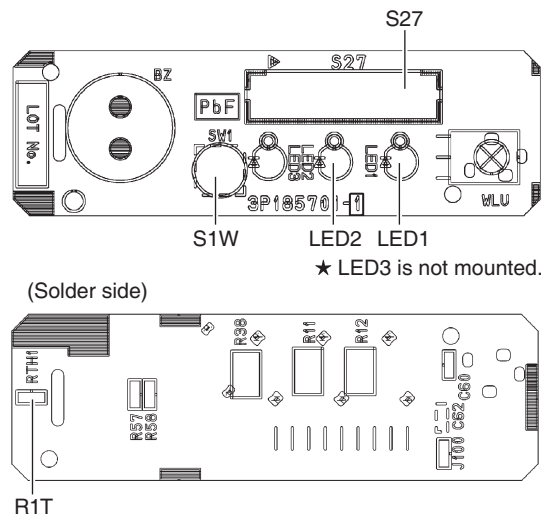

Note

The symbols in the parenthesis are the names on the appropriate wiring diagram.

1.3 FTX18/24WVJU9

Control PCB (PCB1)

- | | | |
|-----|-------------------------|--|
| 1) | S1 | Connector for DC fan motor |
| 2) | S21 | Connector for centralized control (HA) |
| 3) | S25 | Wire harness for INTELLIGENT EYE sensor PCB (PCB4) |
| 4) | S32 | Wire harness for indoor heat exchanger thermistor (R2T) |
| 5) | S41 | Connector for swing motors |
| 6) | S46 | Connector for display PCB (PCB3) |
| 7) | S47 | Wire harness for signal receiver PCB (PCB2) |
| 8) | H1, H2, H3, FG | Wire harness for terminal strip |
| 9) | JA | Address setting jumper
Refer to page 214 for details. |
| 10) | JB | Fan speed setting when compressor stops for thermostat OFF
Refer to page 217 for details. |
| 11) | JC | Power failure recovery function (auto-restart)
Refer to page 217 for details. |
| 12) | LED A | LED for service monitor (green) |
| 13) | FU1 (F1U),
FU2 (F2U) | Fuse (3.15 A, 250 V) |
| 14) | V1 | Varistor |

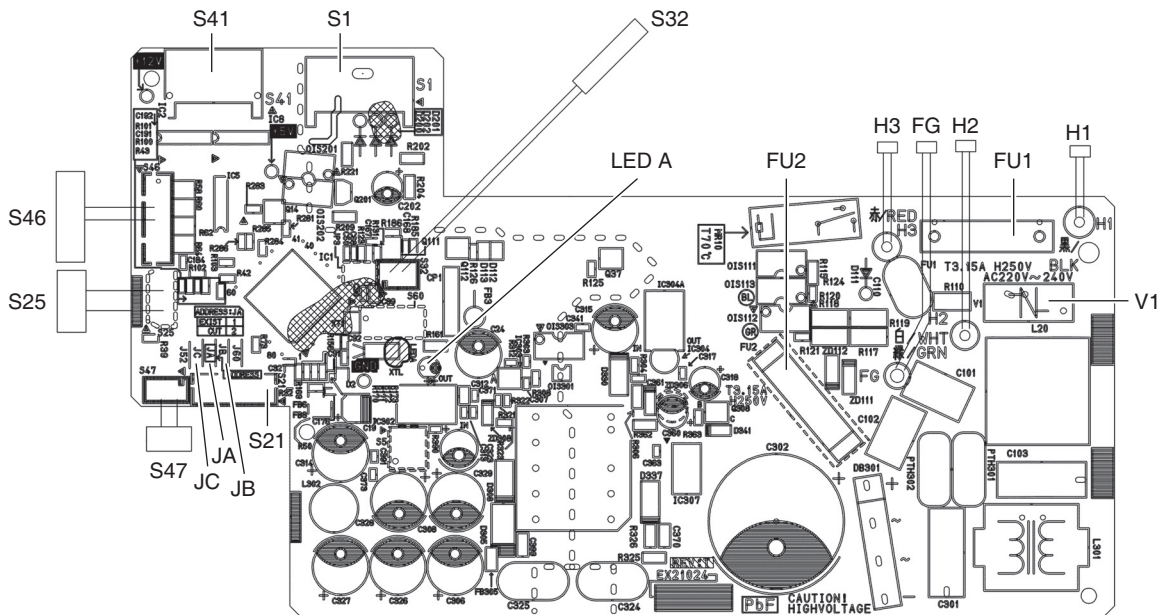

2P677796-6



Caution

Replace the PCB if you cut a jumper unintentionally.

Jumpers are necessary for electronic circuit. Improper operation may occur if you cut any of them.



Note

The symbols in the parenthesis are the names on the appropriate wiring diagram.

Signal Receiver PCB (PCB2)

- 1) S48 Connector for control PCB (PCB1)

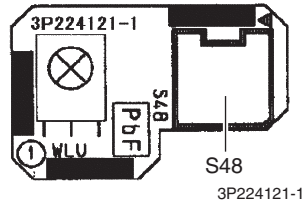

Display PCB (PCB3)

- 1) S49 Connector for control PCB (PCB1)
- 2) SW1 Indoor unit **ON/OFF** switch
(Forced cooling operation **ON/OFF** switch)
Refer to page 206 for details of forced cooling operation.
- 3) LED1 (H1P) LED for operation (green)
- 4) LED2 (H2P) LED for timer (yellow)
- 5) LED3 (H3P) LED for INTELLIGENT EYE (green)
- 6) RTH1 (R1T) Room temperature thermistor

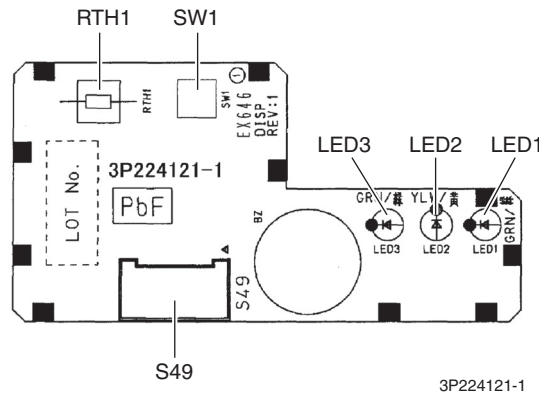

INTELLIGENT EYE Sensor PCB (PCB4)

- 1) S36 Connector for control PCB (PCB1)

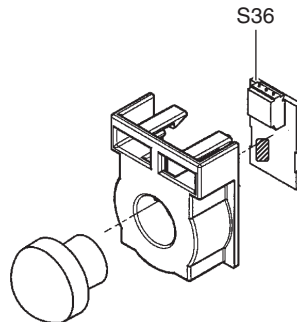

3P227885-1



Note

The symbols in the parenthesis are the names on the appropriate wiring diagram.

1.4 FVXS09/12/15WVJU9

Control PCB (PCB2)

- | | | |
|-----|------------|--|
| 1) | S1 | Connector for DC fan motor |
| 2) | S21 | Connector for centralized control (HA) |
| 3) | S26 | Connector for service PCB (PCB3) |
| 4) | S32 | Wire harness for indoor heat exchanger thermistor (R2T) |
| 5) | S41 | Connector for lower air outlet motor |
| 6) | S42 | Connector for swing motor |
| 7) | S46 | Connector for display/signal receiver PCB (PCB4) |
| 8) | S48 | Connector for sensor PCB (PCB1) |
| 9) | H1, H2, H3 | Wire harness for terminal strip |
| 10) | E1 | Wire harness for ground wire |
| 11) | JA | Address setting jumper
Refer to page 214 for details. |
| 12) | JB | Fan speed setting when compressor stops for thermostat OFF
Refer to page 217 for details. |
| 13) | JC | Power failure recovery function
Refer to page 217 for details. |
| 14) | F1U, F2U | Fuse (3.15 A, 250 V) |
| 15) | LED A | LED for service monitor (green) |
| 16) | V1, V2 | Varistor |

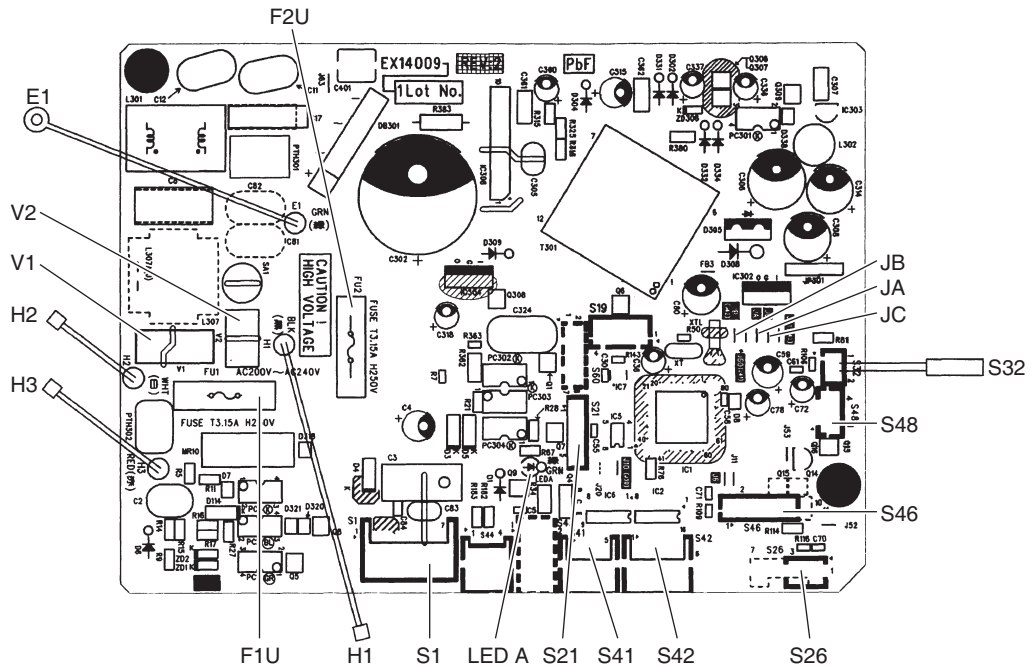

2P383711-1



Caution

Replace the PCB if you cut a jumper unintentionally.

Jumpers are necessary for electronic circuit. Improper operation may occur if you cut any of them.

**Sensor PCB
(PCB1)**

- | | |
|--------|----------------------------------|
| 1) S49 | Connector for control PCB (PCB2) |
| 2) R1T | Room temperature thermistor |

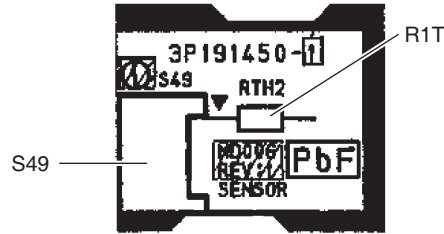

3P191450-1

**Service PCB
(PCB3)**

- | | |
|-----------|--|
| 1) S27 | Connector for control PCB (PCB2) |
| 2) S2W(4) | Switch for upward airflow limit setting
Refer to page 217 for details.
* Keep the other switches as factory setting. |
| 3) S4W | Switch for airflow selection
Refer to page 44 for details. |

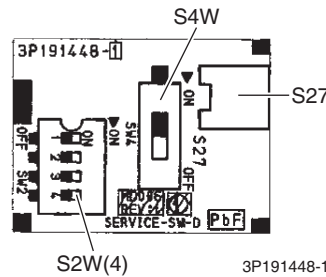

3P191448-1

**Display/Signal
Receiver PCB
(PCB4)**

- | | |
|---------------|---|
| 1) S47 | Connector for control PCB (PCB2) |
| 2) S1W | Indoor unit ON/OFF switch
(Forced cooling operation ON/OFF switch)
Refer to page 206 for details of forced cooling operation. |
| 3) LED1 (H1P) | LED for operation (green) |
| 4) LED2 (H2P) | LED for timer (yellow) |

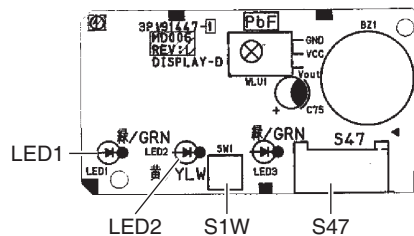

3P191447-1

**Note**

The symbols in the parenthesis are the names on the appropriate wiring diagram.

1.5 FDMQ12/18/24WVJU9

Control PCB (A1P)

- 1) X15A Connector for float switch
- 2) X16A Connector for room temperature thermistor (suction air thermistor) (R1T)
- 3) X17A, X18A Connector for indoor heat exchanger thermistor (R2T, R3T)
- 4) X25A Connector for drain pump motor
- 5) X27A Connector for terminal block (for power supply)
- 6) X28A Connector for power supply wiring (option)
- 7) X30A Connector for terminal block (for wired remote controller)
- 8) X33A Connector for wiring (option)
- 9) X35A Connector for wiring adaptor (option)
- 10) X70A Connector for indoor fan PCB (A2P)
- 11) F1U Fuse (3.15 A, 250 V)
- 12) HAP LED for service monitor (green)
- 13) DS1 DIP switch for emergency

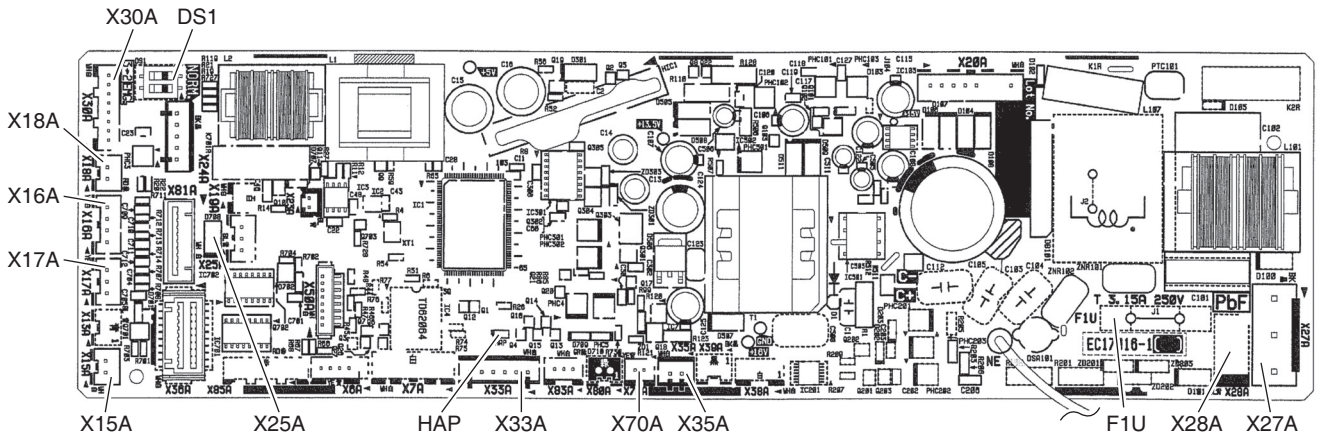

2P486802-3

**Indoor Fan PCB
(A2P)**

- 1) X3A Connector for control PCB (A1P)
- 2) X6A Connector for reactor
- 3) X8A Connector for DC fan motor
- 4) X10A Connector for terminal block (for power supply)
- 5) F2U Fuse (5 A, 250 V)
- 6) F4U Fuse (6.3 A, 250 V)
- 7) HAP LED for service monitor (green)

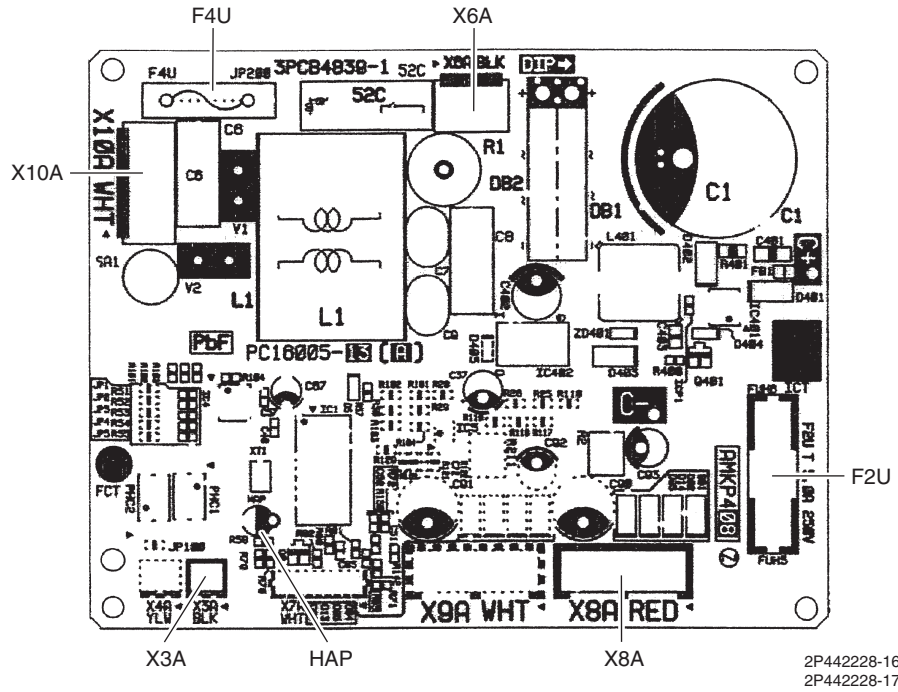

2. Wired Remote Controller

2.1 BRC1E73

Wired Remote Controller PCB

- 1) P1, P2 Terminal for indoor unit
- 2) R4T Room temperature thermistor

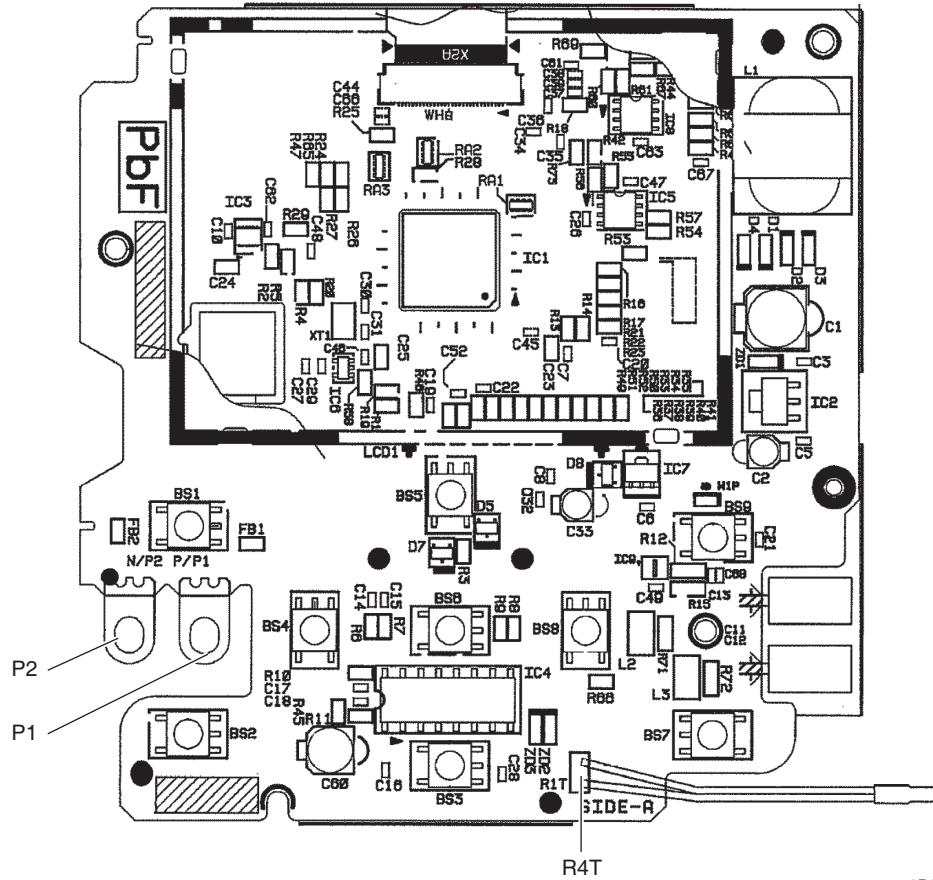

2P619817-7

3. Wireless Remote Controller Receiver for FDMQ Series

3.1 BRC082A43

**Wired Remote
Controller PCB**

- | | | |
|----|--------|---|
| 1) | SS1 | MAIN/SUB setting switch
Refer to page 225 for details. |
| 2) | SS2 | Address setting switch
Refer to page 225 for details. |
| 3) | P1, P2 | Terminal for indoor unit control PCB (A1P) |

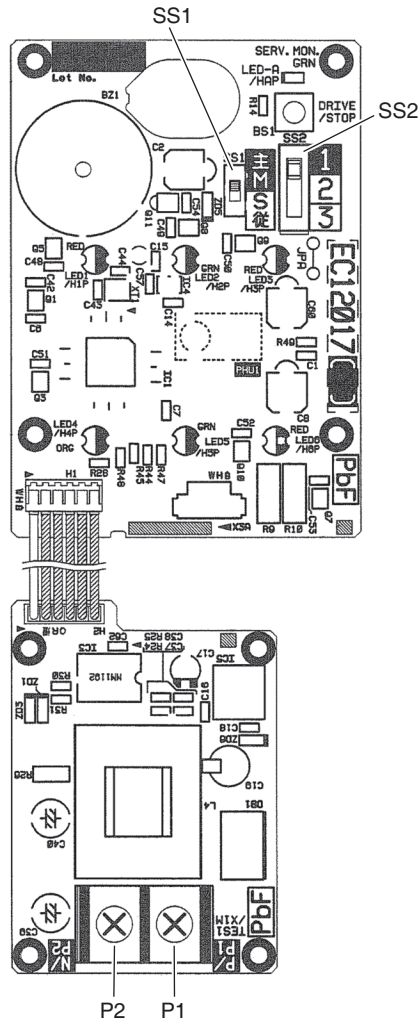

4. Outdoor Unit

4.1 RXL09WMVJU9

Main PCB (PCB1)

1)	S20	Connector for electronic expansion valve coil
2)	S30	Connector for compressor
3)	S40	Connector for overload protector and high pressure switch
4)	S71	Connector for DC fan motor
5)	S80	Connector for four way valve coil
6)	S90	Connector for thermistors (outdoor temperature, outdoor heat exchanger, discharge pipe)
7)	HL1, HN1, S	Wire harness for terminal block
8)	E1, E2	Wire harness for ground wire
9)	HR1, HR2	Wire harness for reactor
10)	FU1, FU2	Fuse (3.15 A, 250 V)
11)	FU3	Fuse (20 A, 250 V)
12)	J5	Jumper for warmer airflow setting Refer to page 230 for details.
13)	J6	Jumper for facility setting Refer to page 228 for details.
14)	J9	Jumper for drain pan heater Refer to page 232 for details.
15)	LED A	LED for service monitor (green)
16)	V2, V3, V150	Varistor

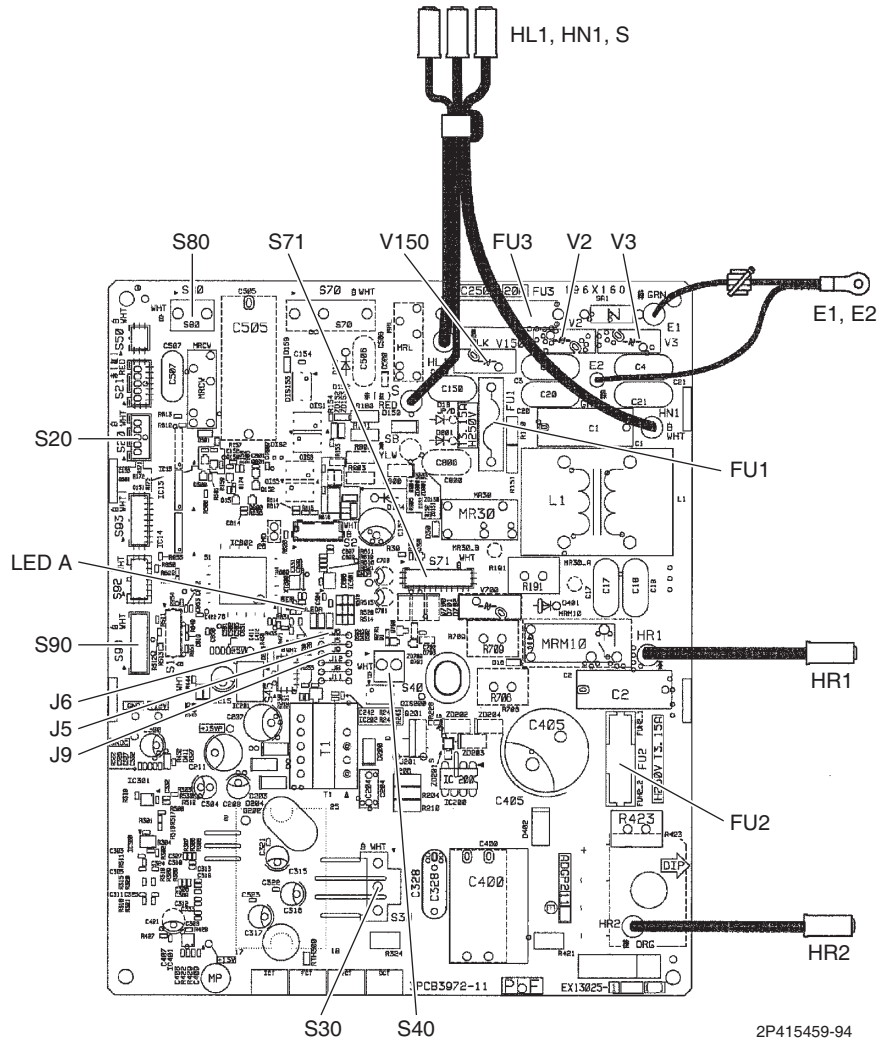

 **Caution**

Replace the PCB if you cut a jumper unintentionally.

Jumpers are necessary for electronic circuit. Improper operation may occur if you cut any of them.

4.2 RXL12WMVJU9

Main PCB (PCB1)

1)	S20	Connector for electronic expansion valve coil
2)	S40	Connector for overload protector and high pressure switch
3)	S70	Connector for DC fan motor
4)	S80	Connector for four way valve coil
5)	S90	Connector for thermistors (outdoor temperature, outdoor heat exchanger, discharge pipe)
6)	HL1, HN1, S	Wire harness for terminal block
7)	E1, E2	Wire harness for ground
8)	U, V, W	Wire harness for compressor
9)	FU1, FU2	Fuse (3.15 A, 250 V)
10)	FU3	Fuse (20 A, 250 V)
11)	J5	Jumper for warmer airflow setting Refer to page 230 for details.
12)	J6	Jumper for facility setting Refer to page 228 for details.
13)	J9	Jumper for drain pan heater Refer to page 232 for details.
14)	LED A	LED for service monitor (green)
15)	V2, V3, V150	Varistor

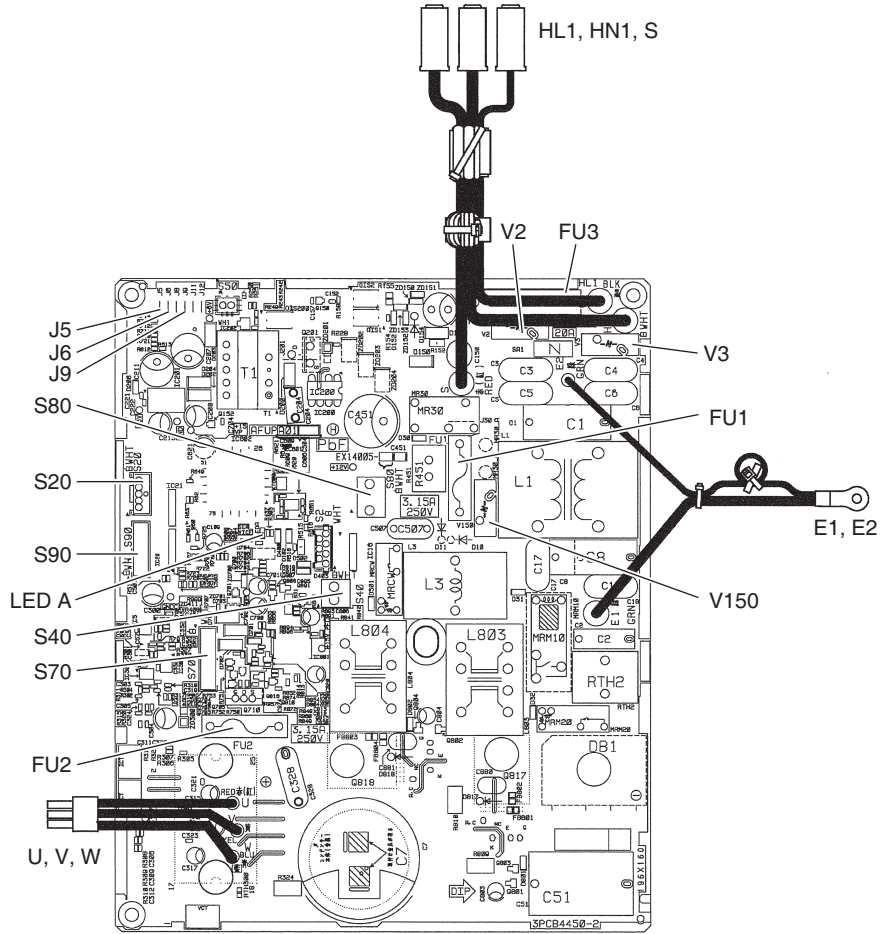

2P575834-16



Caution

Replace the PCB if you cut a jumper unintentionally.

Jumpers are necessary for electronic circuit. Improper operation may occur if you cut any of them.

4.3 RXL15WMVJU9

Main PCB

- 1) S20 Connector for electronic expansion valve coil
- 2) S40 Connector for overload protector and high pressure switch
- 3) S70 Connector for DC fan motor
- 4) S80 Connector for four way valve coil
- 5) S90 Connector for thermistors
(outdoor temperature, outdoor heat exchanger, discharge pipe)
- 6) HL1, HN1, S Wire harness for terminal block
- 7) E1, E2 Wire harness for ground
- 8) U, V, W Wire harness for compressor
- 9) FU1, FU2 Fuse (3.15 A, 250 V)
- 10) FU3 Fuse (30 A, 250 V)
- 11) J5 Jumper for warmer airflow setting
Refer to page 230 for details.
- 12) J6 Jumper for facility setting
Refer to page 228 for details.
- 13) J9 Jumper for drain pan heater
Refer to page 232 for details.
- 14) LED A LED for service monitor (green)
- 15) V1, V2, V3 Varistor

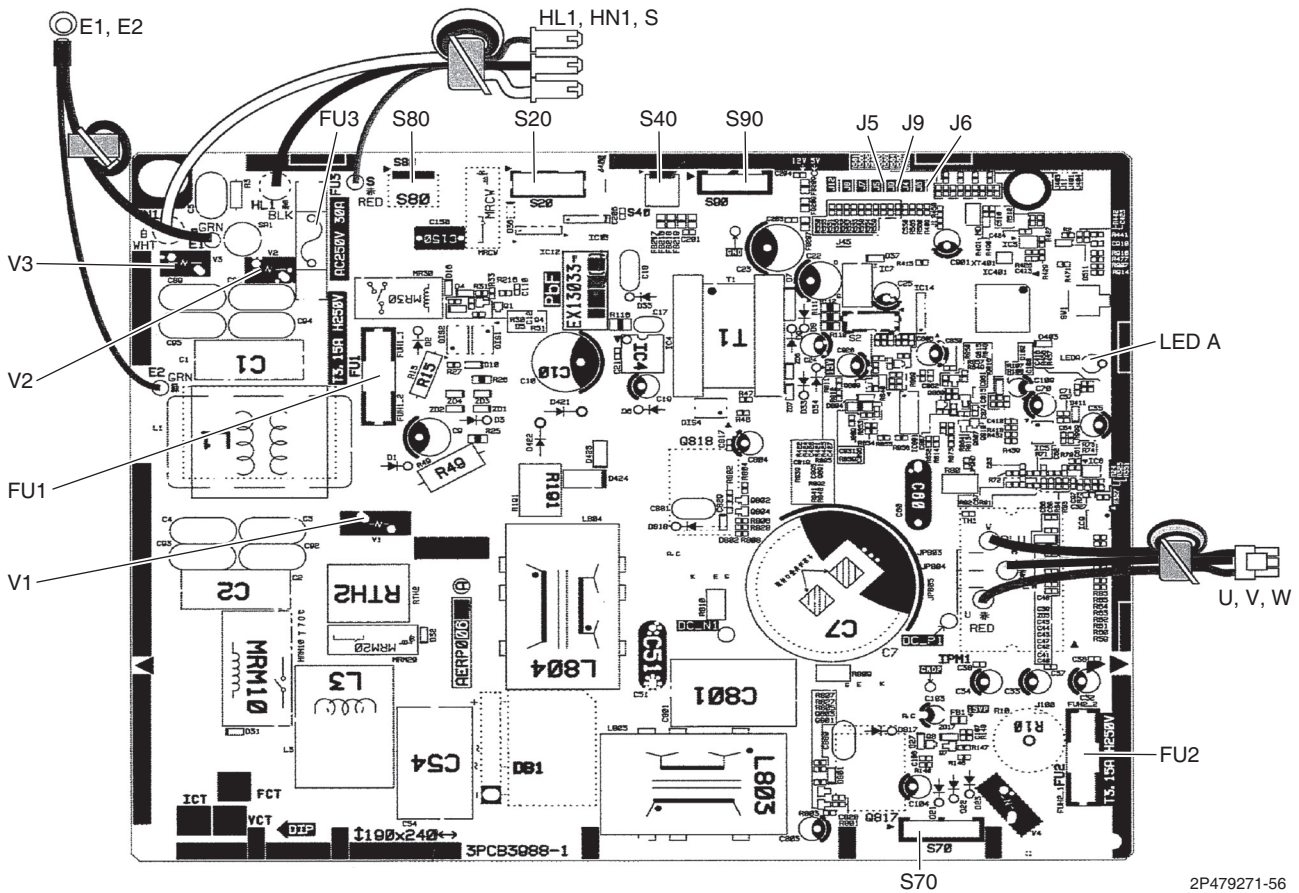

Caution

Replace the PCB if you cut a jumper unintentionally.

Jumpers are necessary for electronic circuit. Improper operation may occur if you cut any of them.

4.4 RXL18/24WMVJU9

Main PCB (PCB1)

- | | |
|------------------|--|
| 1) S | Connector for terminal block (indoor - outdoor transmission) |
| 2) S20 | Connector for electronic expansion valve coil |
| 3) S40 | Connector for overload protector and high pressure switch |
| 4) S70 | Connector for DC fan motor |
| 5) S80 | Connector for four way valve coil |
| 6) S90 | Connector for thermistors
(outdoor temperature, outdoor heat exchanger, discharge pipe) |
| 7) S201, S202 | Wire harness for service monitor PCB (PCB2) |
| 8) CK1 | Wire harness for voltage endurance test |
| 9) HL1, HN1 | Wire harness for terminal block (power supply) |
| 10) E1, E2 | Wire harness for earth/ground wire |
| 11) U, V, W | Wire harness for compressor |
| 12) FU1, FU2 | Fuse (3.15 A, 250 V) |
| 13) FU3 | Fuse (30 A, 250 V) |
| 14) V2, V3, V401 | Varistor |

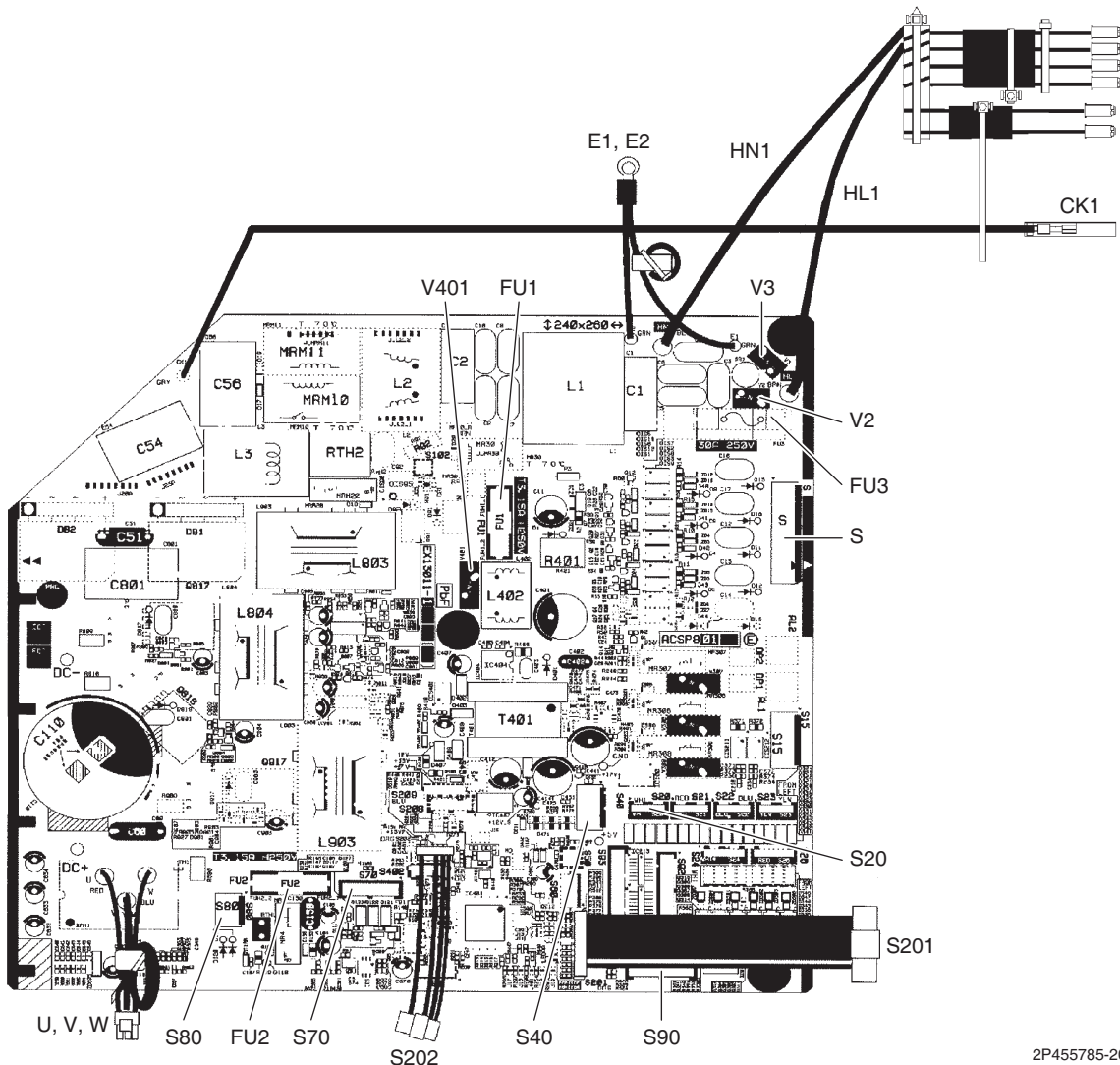

2P455785-20

**Service Monitor
PCB (PCB2)**

- 1) S501, S502 Connector for main PCB (PCB1)
- 2) LEDA LED for service monitor (green)
- 3) SW5-2 Switch for warmer airflow setting
Refer to page 230 for details.
- 4) SW5-3 Switch for facility setting
Refer to page 228 for details.
- 5) SW6-1 Switch for drain pan heater
Refer to page 232 for details.

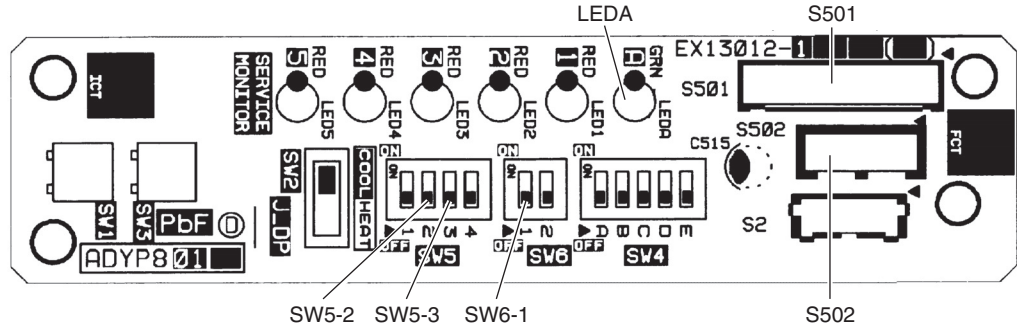

3P346711-10

★ SW1 ~ SW4 and LED1 ~ LED5 do not work.

Part 4

Functions and Control

1. Common Functions	42
1.1 Temperature Control	42
1.2 Frequency Principle.....	42
2. Functions for FTX, FVXS Series	44
2.1 Airflow Direction Control.....	44
2.2 COMFORT AIRFLOW Operation	47
2.3 Fan Speed Control for Indoor Unit	48
2.4 Program Dry Operation	49
2.5 Automatic Cooling/Heating Changeover	50
2.6 Thermostat Control.....	51
2.7 NIGHT SET Mode	52
2.8 ECONO Operation	53
2.9 INTELLIGENT EYE Operation	54
2.10 POWERFUL Operation	55
2.11 Clock Setting	56
2.12 WEEKLY TIMER Operation	57
2.13 Other Functions.....	63
3. Functions for FDMQ Series.....	64
3.1 Fan Speed Control for Indoor Unit	64
3.2 Program Dry Operation	65
3.3 Clock and Calendar Setting (With BRC1E73).....	66
3.4 Schedule Timer Operation (With BRC1E73).....	68
3.5 Drain Pump Control.....	71
3.6 Hot Start Control (In Heating Operation Only).....	73
3.7 Other Functions.....	74
4. Thermistor Functions	75
5. Control Specification	76
5.1 Mode Hierarchy	76
5.2 Frequency Control.....	76
5.3 Controls at Mode Changing/Start-up.....	78
5.4 Discharge Pipe Temperature Control.....	80
5.5 Input Current Control.....	81
5.6 High Pressure Protection Control.....	82
5.7 Freeze-up Protection Control	83
5.8 Heating Peak-cut Control	84
5.9 Outdoor Fan Control.....	85
5.10 Liquid Compression Protection Function.....	85
5.11 Defrost Control	86
5.12 Electronic Expansion Valve Control	87

5.13 Malfunctions 90

1. Common Functions

1.1 Temperature Control

Definitions of Temperatures

The definitions of temperatures are classified as following.

- Room temperature: temperature of lower part of the room
- Set temperature: temperature set by remote controller
- Room thermistor temperature: temperature detected by room temperature thermistor
- Target temperature: temperature determined by microcomputer

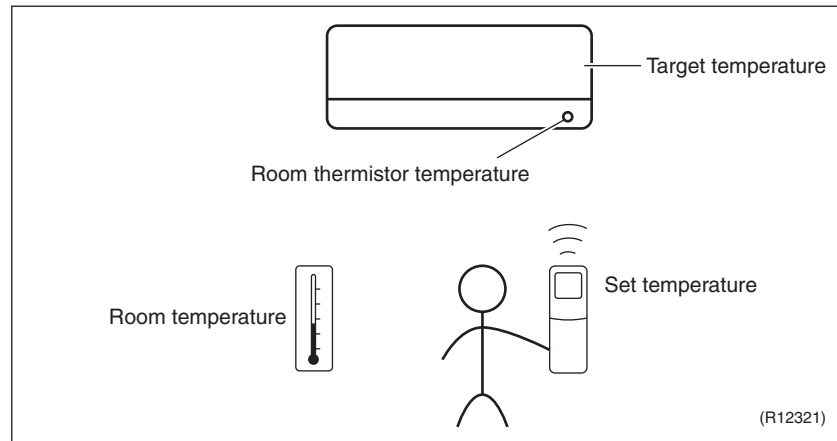

★ The illustration is for wall mounted type as representative.

Temperature Control

The temperature of the room is detected by the room temperature thermistor. However, there is a difference between the temperature detected by room temperature thermistor and the temperature of lower part of the room, depending on the type of the indoor unit or installation condition. In practice, the temperature control is done by the target temperature appropriately adjusted for the indoor unit and the temperature detected by room temperature thermistor.

1.2 Frequency Principle

Control Parameters

The frequency of the compressor is controlled by the following 2 parameters:

- The load condition of the operating indoor unit
- The difference between the room thermistor temperature and the target temperature

The target frequency is adapted by additional parameters in the following cases:

- Frequency restrictions
- Initial settings
- Forced cooling operation

Inverter Principle

To regulate the capacity, a frequency control is needed. The inverter makes it possible to control the rotation speed of the compressor. The followings explain the inverter principle:

Phase 1

The supplied AC power source is converted into the DC power source for the present.

Phase 2

The DC power source is reconverted into the three phase AC power source with variable frequency.

- When the frequency increases, the rotation speed of the compressor increases resulting in an increase of refrigerant circulation. This leads to a larger amount of heat exchange per unit.
- When the frequency decreases, the rotation speed of the compressor decreases resulting in a decrease of refrigerant circulation. This leads to a smaller amount of heat exchange per unit.

The following drawing shows a schematic view of the inverter principle:

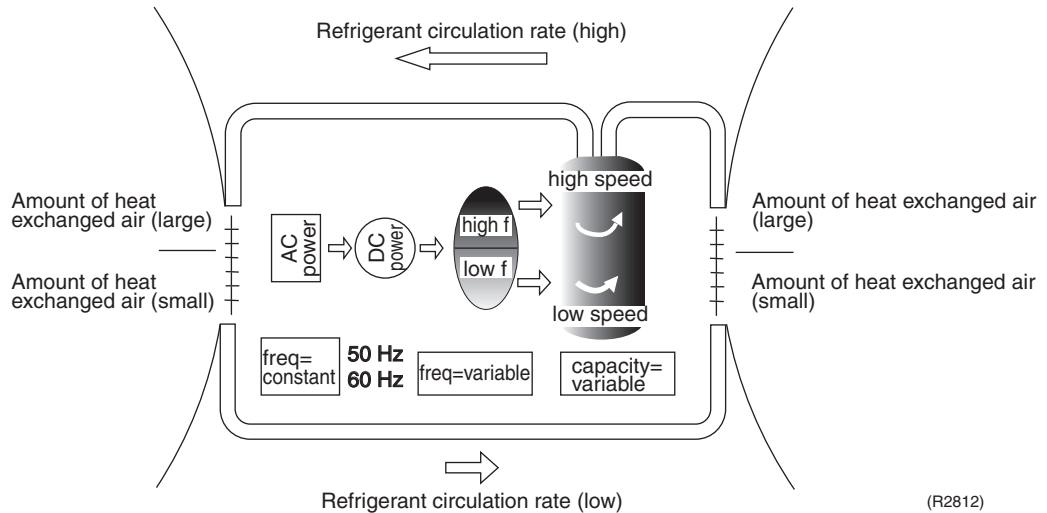

Inverter Features

The inverter provides the following features:

- The regulating capacity can be changed according to the changes in the outdoor temperature and cooling/heating load.
- Quick heating and quick cooling
The rotation speed of the compressor is increased when starting the heating (cooling). This enables to reach the set temperature quickly.
- Even during extreme cold weather, high capacity is achieved. It is maintained even when the outdoor temperature is 2°C (35.6°F).
- Comfortable air conditioning
A fine adjustment is integrated to keep the room temperature constant.
- Energy saving heating and cooling
Once the set temperature is reached, the energy saving operation enables to maintain the room temperature at low power.

Frequency Limits

The following functions regulate maximum frequency:

Low frequency

- Four way valve operation compensation. Refer to page 79.

High frequency

- Compressor protection function. Refer to page 79.
- Discharge pipe temperature control. Refer to page 80.
- Input current control. Refer to page 81.
- Freeze-up protection control. Refer to page 83.
- Heating peak-cut control. Refer to page 84.
- Defrost control. Refer to page 86.

Forced Cooling Operation

Refer to page 206 for details.

2. Functions for FTX, FVXS Series

2.1 Airflow Direction Control

Power-Airflow (Dual) Flap(s)

The large flap sends a large volume of air downward to the floor and provides an optimum control in cooling, dry and heating operation.

Cooling/Dry

During cooling or dry operation, the flap retracts into the indoor unit. Then, cool air can be blown far and distributed all over the room.

Heating

During heating operation, the large flap directs airflow downward to spread the warm air to the entire room.



Wide-Angle Louvers

The louvers, made of elastic synthetic resin, provide a wide range of airflow that guarantees comfortable air distribution.

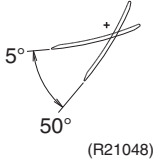
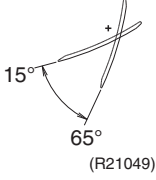
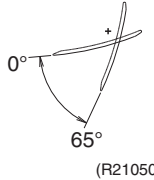
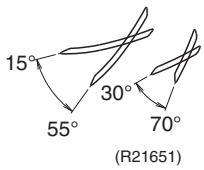
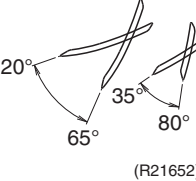
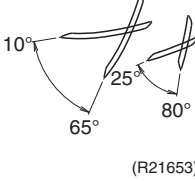
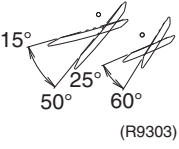
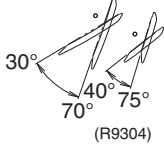
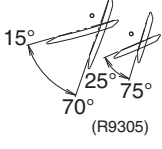

Auto-Swing

The following tables explain the auto-swing process for cooling, dry, heating and fan:

FTX Series

	Flap (up and down)			Louver (right and left)
	Cooling/Dry	Heating	Fan	
09/12 class				—
15 class				—
18/24 class				

FVXS Series

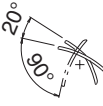
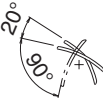
	Flap (up and down)	
	Cooling/Dry	Heating
Upward airflow limit OFF	 R4003397	 R4003396
Upward airflow limit ON	 R4003394	 R4003394

3-D Airflow

FTX18/24 only

Alternative repetition of vertical and horizontal swing motions enables uniform air-conditioning of the entire room.

When the horizontal swing and vertical swing are both set to automatic operation, the airflow becomes 3-D airflow. The horizontal and vertical swing motions are alternated and the airflow direction changes in the order shown in the following diagram.

- (1) The vertical blades (louvers) move from the right to the left.
- (2) The horizontal blades (flaps) move downward.
- (3) The vertical blades (louvers) move from the left to the right.
- (4) The horizontal blades (flaps) move upward.

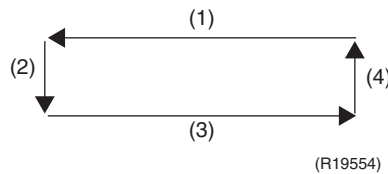

Airflow Selection Setting

FVXS Series

Airflow direction can be set with the airflow selection switch.

- Open the front panel.

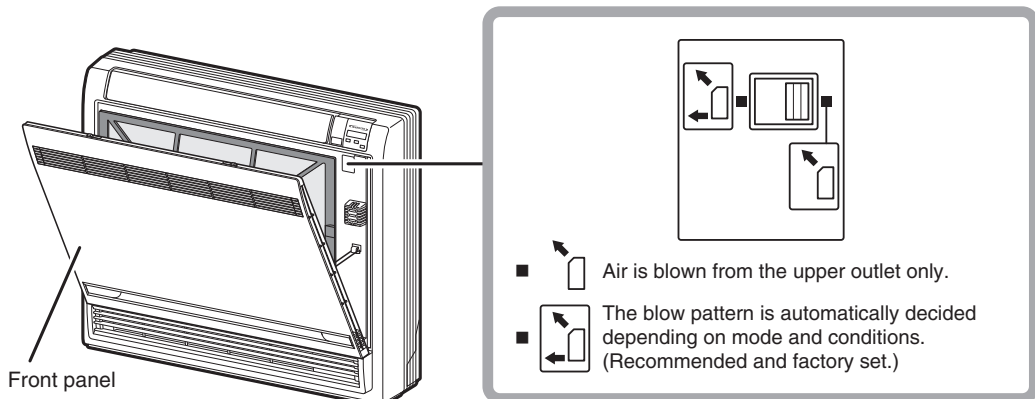

(R17866)









Caution

Before opening the front panel, be sure to stop the operation and turn the breaker off. Do not touch the aluminum fins (indoor heat exchanger) inside the indoor unit, as it may result in injury.

When setting the airflow selection switch to .

- The air conditioner automatically decides the appropriate blowing pattern depending on the operating mode/situation.

Operating mode	Situation	Blowing pattern	
Cooling	When the operation is activated or when the room is not fully cooled.		Air is blown from the upper and lower air outlets in order to reach the set temperature quickly.
	When the room has become fully cool, or when 1 hour has passed since turning on the air conditioner.		Air is blown only from the upper air outlet so that air does not come into direct contact with people and indoor temperature is equalized.
Heating	When the operation is activated or when air emitted is of low temperature.		Air is blown only from the upper air outlet so that air does not come into direct contact with people.
	At times other than the above situations.		Air is blown from the upper and lower air outlets so that warm air is spread throughout the whole room.
Dry	Whenever in DRY mode.		Air is blown only from the upper air outlet so that air does not come into direct contact with people.
Fan	Whenever in FAN mode.		—
Automatic	Operates in the actual operation mode of the air conditioner according to the descriptions in this table. (COOL or HEAT)		

- ◆ During dry operation, air is blown from upper air outlet, so that cold air does not come into direct contact with people.

When setting the airflow selection switch to .

- Regardless of the operating mode or situation, air is blown from the upper air outlet.
- Use this switch when you do not want air coming out of the lower air outlet (e.g., while sleeping).



2.2 COMFORT AIRFLOW Operation

Applicable Models

FTX09/12/15WMVJU9
FTX18/24WVJU9

Outline

The horizontal blades (louvers) are controlled not to blow the air directly at the people in the room.

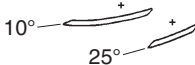
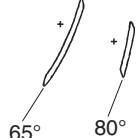
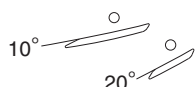
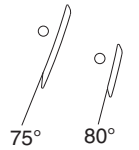
	Cooling	Heating
09/12 class	 R4003675	 R4003676
15 class	 R4003682	 R4003683
18/24 class	 R4003684	 R4003679

- The fan speed is controlled automatically within the following steps.
 - Cooling**
L tap ~ MH tap (same as automatic)
 - Heating**
L tap ~ M tap
- The latest command has the priority between POWERFUL and COMFORT AIRFLOW.

2.3 Fan Speed Control for Indoor Unit

Outline

Phase control and fan speed control contains 9 steps: LLL, LL, SL, L, ML, M, MH, H, and HH. The airflow rate can be automatically controlled depending on the difference between the room thermistor temperature and the target temperature.

Automatic Fan Speed Control

In automatic fan speed operation, the step SL is not available.

Step	Cooling	Heating
LLL	↕	↕
LL		
L		
ML		
M		
MH		
H		
HH (POWERFUL)		

↕ = The airflow rate is automatically controlled within this range when **FAN** setting button is set to automatic. R4003512

■ Cooling

The following drawing explains the principle of fan speed control for cooling.

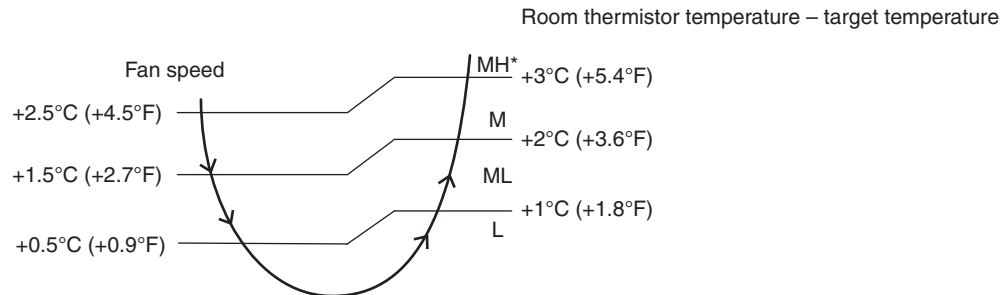

(R21654)

* The upper limit is at M tap in 30 minutes from the operation start.

■ Heating

In heating operation, the fan speed is regulated according to the indoor heat exchanger temperature and the difference between the room thermistor temperature and the target temperature.



Note(s)

The fan stops during defrost operation.

2.4 Program Dry Operation

Outline

Program dry operation removes humidity while preventing the room temperature from lowering. Since the microcomputer controls both the temperature and airflow rate, the temperature adjustment and **FAN** setting buttons are inoperable.

Details

The microcomputer automatically sets the temperature and airflow rate. The difference between the room thermistor temperature at start-up and the target temperature is divided into two zones. Then, the unit operates in an appropriate capacity for each zone to maintain the temperature and humidity at a comfortable level.

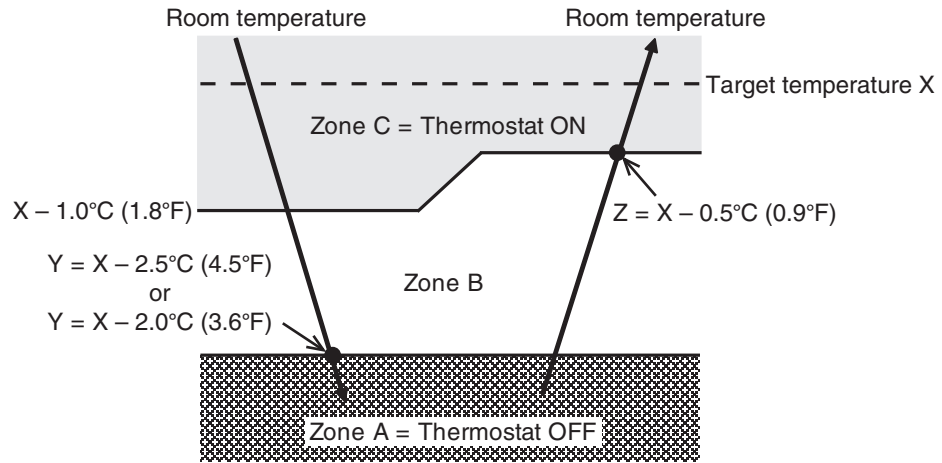

(R23000)

Room thermistor temperature at start-up	Target temperature X	Thermostat OFF point Y	Thermostat ON point Z ★
24°C or more (75.2°F or more)	Room thermistor temperature at start-up	X - 2.5°C (X - 4.5°F)	X - 0.5°C (X - 0.9°F)
18 ~ 23.5°C (64.4 ~ 74.3°F)		X - 2.0°C (X - 3.6°F)	X - 0.5°C (X - 0.9°F)
17.5°C or less (63.5°F or less)	18°C (64.4°F)	X - 2.0°C (X - 3.6°F)	X - 0.5°C = 17.5°C (X - 0.9°F = 63.5°F)

★ Thermostat turns on also when the room temperature is in the zone B for 10 minutes.

2.5 Automatic Cooling/Heating Changeover

Outline

When the automatic operation is selected with the remote controller, the microcomputer automatically determines the operation mode as cooling or heating according to the room temperature and the set temperature at start-up.

The unit automatically switches the operation mode to maintain the room temperature at the set temperature.

Details

Ts: set temperature (set by remote controller)

Tt: target temperature (determined by microcomputer)

Tr: room thermistor temperature (detected by room temperature thermistor)

C: correction value

- The set temperature (Ts) determines the target temperature (Tt).
(Ts = 18 ~ 30°C (64.4 ~ 86°F))
- The target temperature (Tt) is calculated as;
Tt = Ts + C
where C is the correction value.
C = 0°C (0°F)
- Thermostat ON/OFF point and operation mode switching point are as follows.
 - Heating → Cooling switching point:
Tr ≥ Tt + 3.0°C (+ 5.4°F)
 - Cooling → Heating switching point:
Tr < Tt - 3.0°C (- 5.4°F) (FTX09/12/15)
Tr < Tt - 2.5°C (- 4.5°F) (FTX18/24)
 - Thermostat ON/OFF point is the same as the ON/OFF point of cooling or heating operation.
- During initial operation
Tr ≥ Ts : Cooling operation
Tr < Ts : Heating operation

FTX09/12/15, FVXS

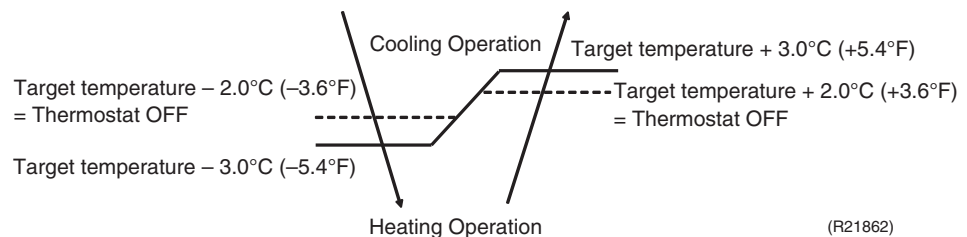

Ex: When the target temperature is 25°C (77°F)

Cooling → 23°C (73.4°F): Thermostat OFF → 22°C (71.6°F): Switch to heating

Heating → 27°C (80.6°F): Thermostat OFF → 28°C (82.4°F): Switch to cooling

FTX18/24

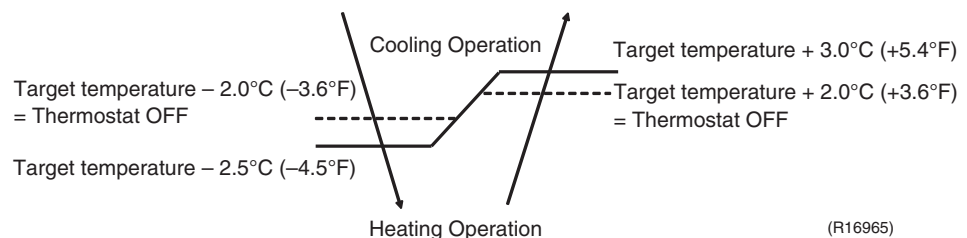

Ex: When the target temperature is 25°C (77°F)

Cooling → 23°C (73.4°F): Thermostat OFF → 22.5°C (72.5°F): Switch to heating

Heating → 27°C (80.6°F): Thermostat OFF → 28°C (82.4°F): Switch to cooling

2.6 Thermostat Control

Outline

Thermostat control is based on the difference between the room thermistor temperature and the target temperature.

Details

Thermostat OFF Condition

- The temperature difference is in the zone A.

Thermostat ON Conditions

- The temperature difference returns to the zone C after being in the zone A.
- The system resumes from defrost control in any zones except A.
- The operation turns on in any zones except A.
- The temperature difference remains in zone B for the determined monitoring time.

	Cooling	Dry	Heating
FTX09/12/15	10 minutes	7.5 minutes	10 seconds
FTX18/24	10 minutes	10 minutes	10 seconds
FVXS	10 minutes	10 minutes	10 seconds

Cooling/Dry

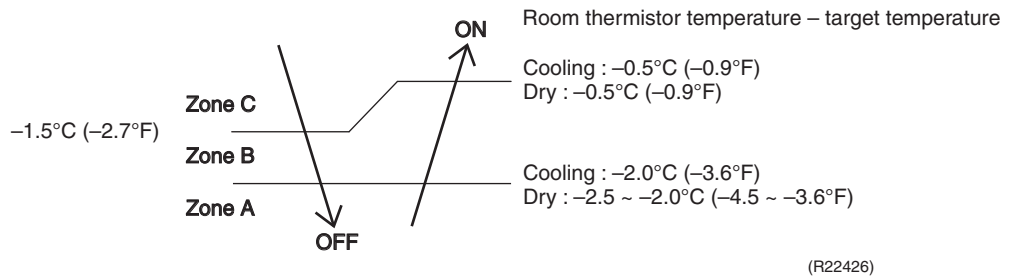

**Heating
FTX Series**

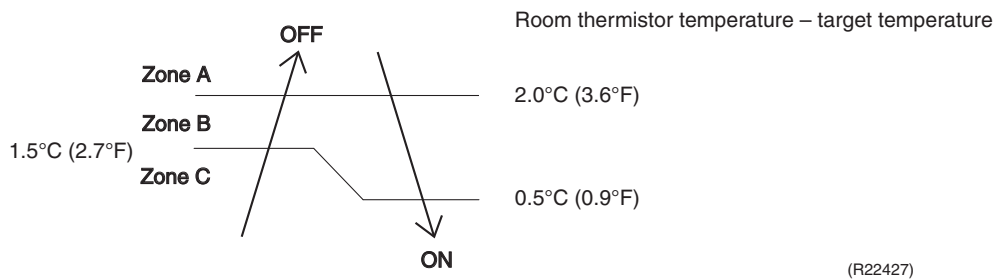

FVXS Series

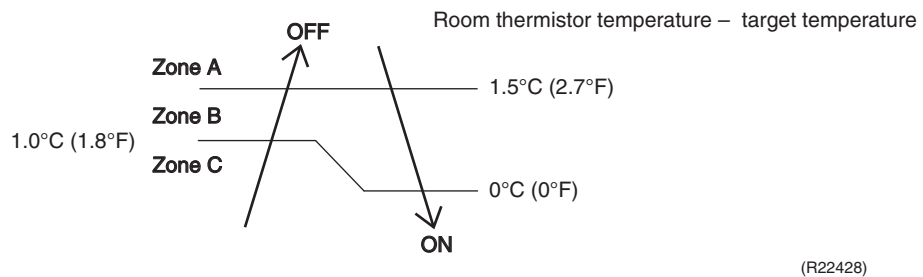

Reference

Refer to Temperature Control on page 42 for details.

2.7 NIGHT SET Mode

Outline

When the OFF TIMER is set, NIGHT SET mode is automatically activated. NIGHT SET mode keeps the airflow rate setting.

Details

NIGHT SET mode continues operation at the target temperature for the first one hour, then automatically raises the target temperature slightly in the case of cooling, or lowers the target temperature slightly in the case of heating. This prevents excessive cooling in summer and excessive heating in winter to ensure comfortable sleeping conditions, and also conserves electricity.

Cooling

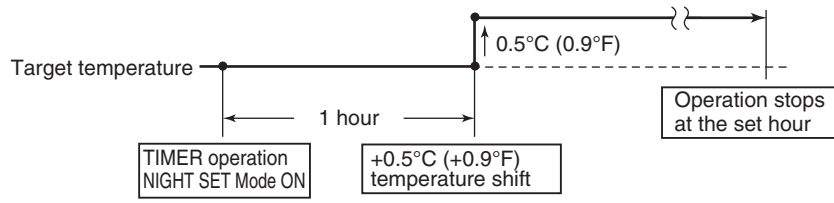

(R23917)

Heating

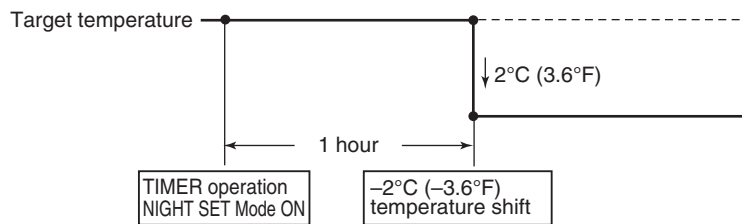

(R23918)

2.8 ECONO Operation

Outline

ECONO operation reduces the maximum operating current and the power consumption. This operation is particularly convenient for energy-saving. It is also a major bonus when breaker capacity does not allow the use of multiple electrical devices and air conditioners. It can be easily activated by pressing **ECONO** or **Econo/Quiet** button on the wireless remote controller.

Details

- When this function is activated, the maximum capacity also decreases.
- The remote controller can send the ECONO command when the unit is in cooling, heating, dry, or automatic operation. This function can only be set when the unit is running. To cancel the ECONO operation, press **ECONO** or **Econo/Quiet** button several times until the ECONO symbol on the remote controller disappears.
- This function and POWERFUL operation cannot be used at the same time. The latest command has the priority.

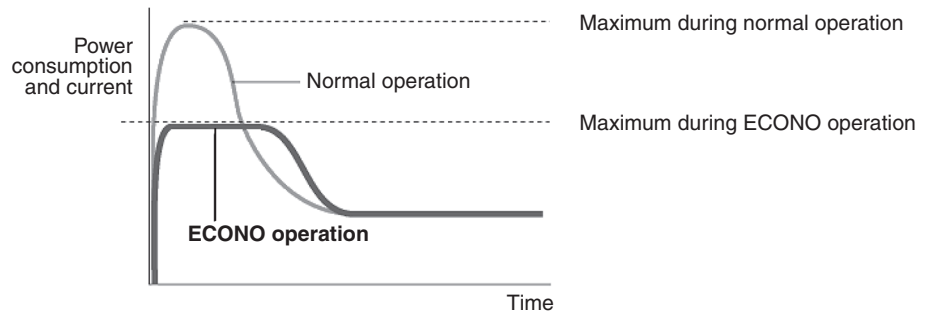

(R22012)

2.9 INTELLIGENT EYE Operation

Applicable Models

FTX18/24WVJU9

Outline

The microcomputer detects the presence with a motion sensor and reduces the capacity when there is nobody in the room in order to save electricity.

Details

1. INTELLIGENT EYE detection method

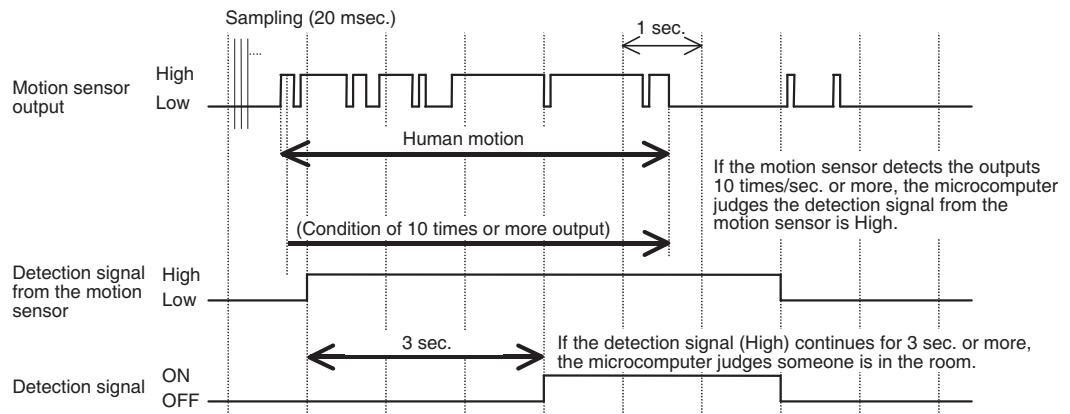

R4003448

- The motion sensor detects human motion by receiving infrared rays and sends the pulse wave output.
- The microcomputer in the indoor unit carries out a sampling every 20 msec. If the motion sensor detects 10 times or more of the wave output in one second in total, and the High signal continues for 3 sec., the microcomputer judges someone is in the room as the detection signal is ON.

2. Motions (in cooling)

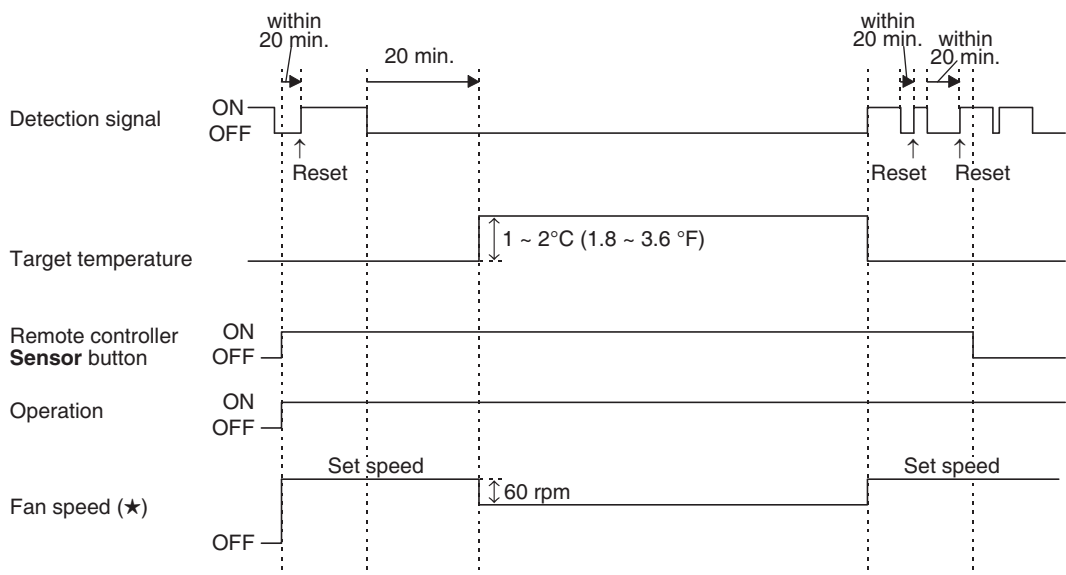

R4003436

- ★ In FAN operation, the fan speed is reduced by 60 rpm when no one is in the area.
- When there is no signal from the motion sensor in 20 minutes, the microcomputer judges that nobody is in the room and operates the unit at a temperature shifted from the target temperature. (Cooling/Dry: 1 ~ 2°C (1.8 ~ 3.6°F) higher, Heating: 2°C (3.6°F) lower, Auto: according to the operation mode at that time)



Note(s)

For dry operation, the temperature cannot be set with a remote controller, but the target temperature is shifted internally.

2.10 POWERFUL Operation

Outline

In order to exploit the cooling and heating capacity to full extent, the air conditioner can be operated by increasing the indoor fan rotating speed and the compressor frequency.

Details

When **POWERFUL** button is pressed, the fan speed and target temperature are converted to the following states for 20 minutes.

Operation mode	Fan speed	Target temperature
COOL	H tap + A rpm	18°C (64.4°F)
DRY	Dry rotating speed + A rpm	Lowered by 2.5°C (4.5°F)
HEAT	H tap + A rpm	B
FAN	H tap + A rpm	—
AUTO	Same as cooling/heating in POWERFUL operation	The target temperature is kept unchanged.

A = FTX09/12/15: 80 (rpm)
 FTX18/24: 50 (rpm)
 FVXS: 30 ~ 40 (rpm)

B = FTX09/12/15: 31°C (87.8°F)
 FTX18/24: 31.5°C (88.7°F)
 FVXS: 32°C (89.6°F)

Ex: POWERFUL operation in cooling

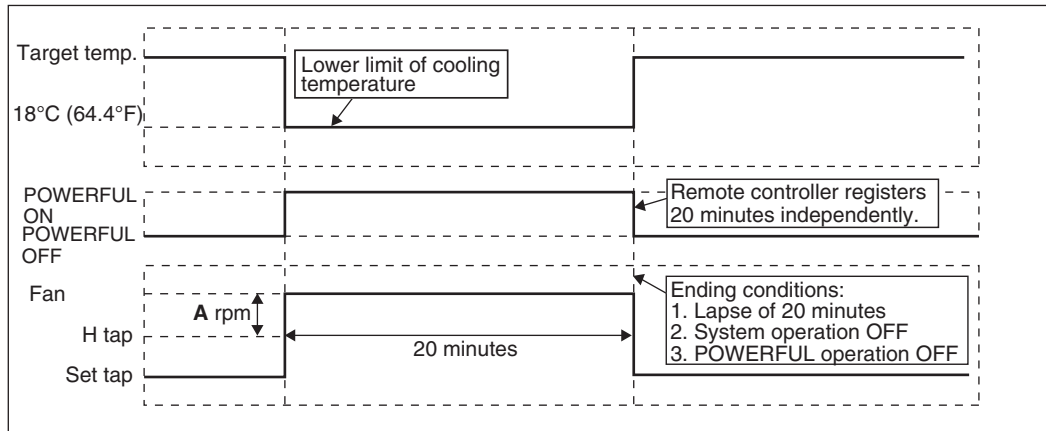

(R24589)





Note(s)

- POWERFUL operation cannot be used together with ECONO, COMFORT AIRFLOW, or QUIET OUTDOOR UNIT operation.

2.11 Clock Setting

ARC466 Series

The clock can be set by taking the following steps:

1. Press **Clock** button.
→ **0:00** is displayed, then **MON** and  blink.
2. Press **Select ▲** or **Select ▼** button to set the clock to the current day of the week.
3. Press **Clock** button.
→  blinks.
4. Press **Select ▲** or **Select ▼** button to set the clock to the present time.
Holding down **Select ▲** or **Select ▼** button rapidly increases or decreases the time display.
5. Press **Clock** button to set the clock. Point the remote controller at the indoor unit when pressing the button.
→  : blinks and clock setting is completed.

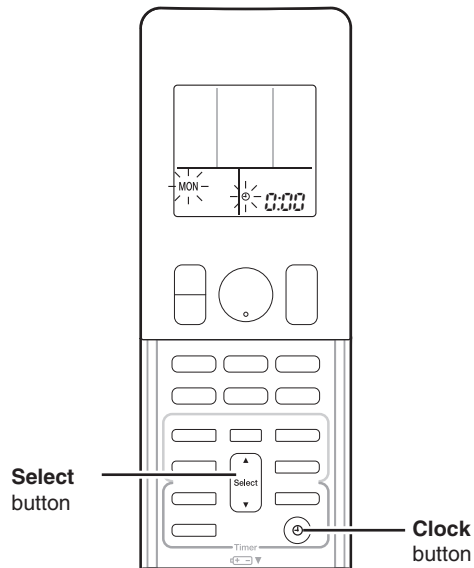

(R19926)

2.12 WEEKLY TIMER Operation

Applicable Models

FTX18/24WVJU9
FVXS09/12/15WVJU9

Outline

Up to 4 timer settings can be saved for each day of the week (up to 28 settings in total). The 3 items: ON/OFF, temperature, and time can be set.

Details

★ The illustrations are for FVXS series as representative.

Setting example of the WEEKLY TIMER

The same timer settings are used from Monday through Friday, while different timer settings are used for the weekend.

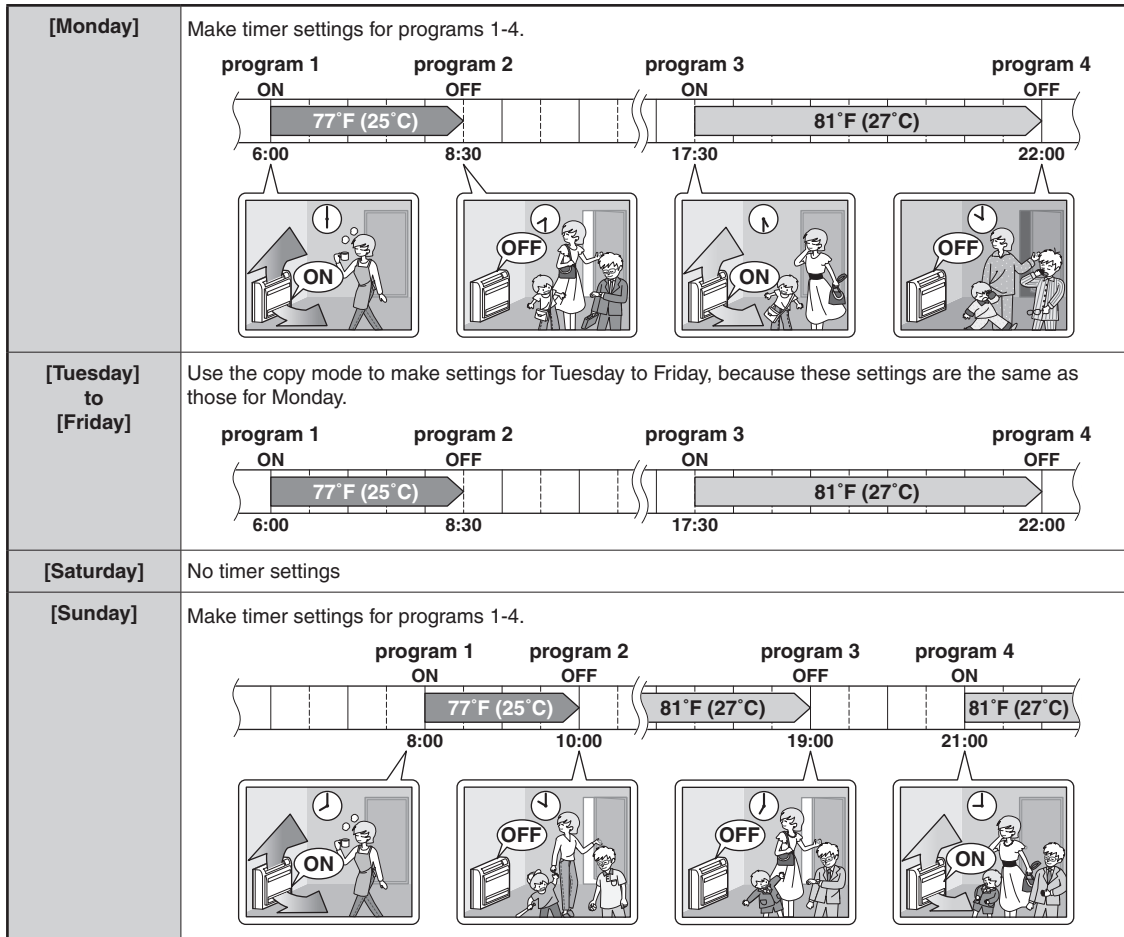

- Up to 4 reservations per day and 28 reservations per week can be set using the WEEKLY TIMER. The effective use of the copy mode simplifies timer programming.
- The use of ON-ON-ON-ON settings, for example, makes it possible to schedule operating mode and set temperature changes. Furthermore, by using OFF-OFF-OFF-OFF settings, only the turn off time of each day can be set. This will turn off the air conditioner automatically if you forget to turn it off.

R4003657

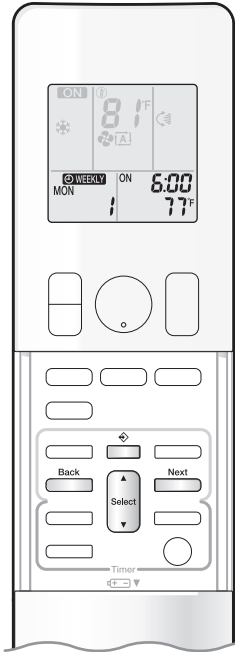

To use WEEKLY TIMER operation

Setting mode

- Make sure the day of the week and time are set. If not, set the day of the week and time.

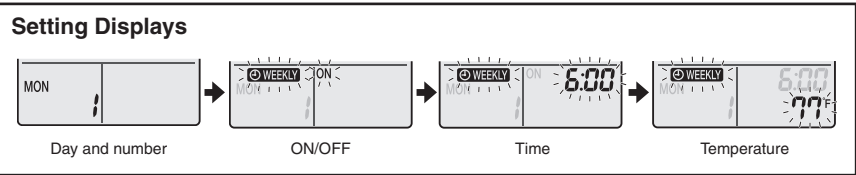
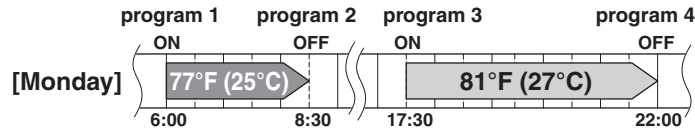

1. Press [Up Arrow].

- The day of the week and the reservation number of the current day will be displayed.
- 1 to 4 settings can be made per day.

2. Press [Select] to select the desired day of the week and reservation number.

- Pressing [Select] changes the reservation number and the day of the week.

3. Press [Next].

- The day of the week and reservation number will be set.
- "WEEKLY" and "ON" blink.

4. Press [Select] to select the desired mode.

- Pressing [Select] changes the "ON" or "OFF" setting in sequence.



- In case the reservation has already been set, selecting "blank" deletes the reservation.
- Proceed to **STEP 9** if "blank" is selected.
- To return to the day of the week and reservation number setting, press [Back].

5. Press [Next].

- The ON/OFF TIMER mode will be set.
- "WEEKLY" and the time blink.

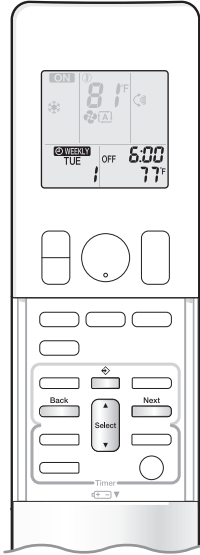

6. Press  to select the desired time.

- The time can be set between 0:00 and 23:50 in 10-minute intervals.
- To return to the ON/OFF TIMER mode setting, press .
- Proceed to **STEP 9** when setting the OFF TIMER.

7. Press  .

- The time will be set.
- “ WEEKLY ” and the temperature blink.

8. Press  to select the desired temperature.

- The temperature can be set between 50°F (10°C) and 90°F (32°C).
COOL or AUTO: The unit operates at 64°F (18°C) even if it is set at 50°F (10°C) to 63°F (17°C).
HEAT or AUTO : The unit operates at 86°F (30°C) even if it is set at 87°F (31°C) to 90°F (32°C).
- To return to the time setting, press .
- The set temperature is only displayed when the mode setting is on.

9. Press  .

- The temperature will be set and go to the next reservation setting.
- The temperature is set while in ON TIMER operation, and the time is set while in OFF TIMER operation.
- The next reservation screen will appear.
- To continue further settings, repeat the procedure from **STEP 4**.

10. Press  to complete the setting.

- Be sure to direct the remote controller toward the indoor unit and check for a receiving tone and blinking of the OPERATION lamp.
- “ WEEKLY ” is displayed on the LCD and WEEKLY TIMER operation is activated.
- The TIMER lamp lights orange.

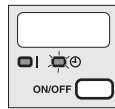



Display

- A reservation made once can be easily copied and the same settings used for another day of the week. Refer to **Copy mode** .

NOTE

Notes on WEEKLY TIMER operation

- Do not forget to set the clock on the remote controller first.
- The day of the week, ON/OFF TIMER mode, time and set temperature (only for ON TIMER mode) can be set with the WEEKLY TIMER. Other settings for the ON TIMER are based on the settings just before the operation.
- WEEKLY TIMER and ON/OFF TIMER operation cannot be used at the same time. The ON/OFF TIMER operation has priority if it is set while WEEKLY TIMER is still active. The WEEKLY TIMER will enter the standby state, and “ WEEKLY ” will disappear from the LCD. When the ON/OFF TIMER is up, the WEEKLY TIMER will automatically become active.
- Only the time and set temperature with the WEEKLY TIMER are sent with the  . Set the WEEKLY TIMER only after setting the operation mode, the airflow rate and the airflow direction ahead of time.
- Turning off the circuit breaker, power failure, and other similar events will render operation of the indoor unit's internal clock inaccurate. Reset the clock.
-  can be used only for the time and temperature settings. It cannot be used to go back to the reservation number.

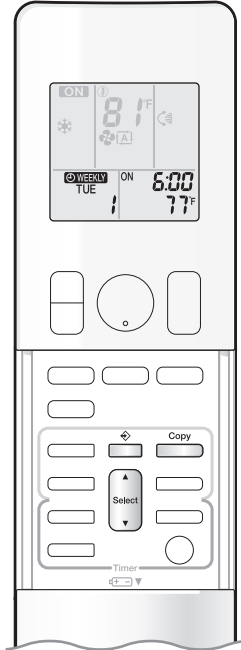

Copy mode

- A reservation made once can be copied to another day of the week. The whole reservation of the selected day of the week will be copied.

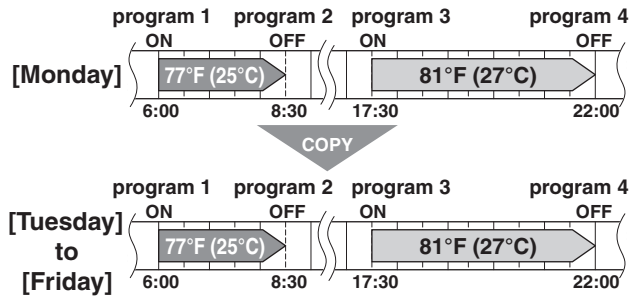

Setting Displays

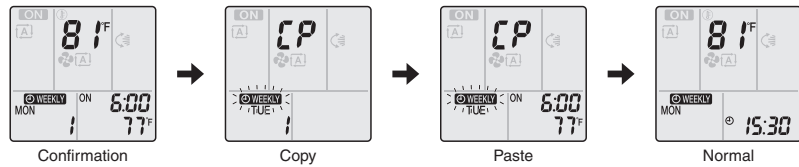

1. Press .
2. Press to confirm the day of the week to be copied.
3. Press .
 - The whole reservation of the selected day of the week will be copied.
4. Press to select the destination day of the week.
5. Press .
 - The reservation will be copied to the selected day of the week. The whole reservation of the selected day of the week will be copied.
 - To continue copying the settings to other days of the week, repeat **STEP 4** and **STEP 5**.
6. Press to complete the setting.
 - “ WEEKLY” is displayed on the LCD and WEEKLY TIMER operation is activated.
 - The TIMER lamp periodically lights orange.

NOTE

Note on COPY MODE

- The entire reservation of the source day of the week is copied in the copy mode.
- In the case of making a reservation change for any day of the week individually after copying the content of weekly reservations, press and change the settings in the steps of **Setting mode**.

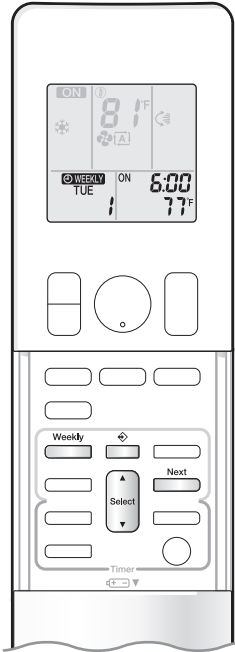

Confirming a reservation

- The reservation can be confirmed.

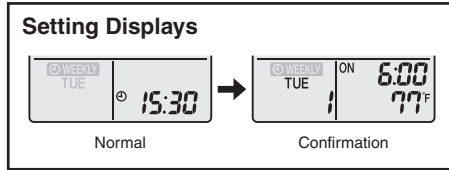

1. Press .

- The day of the week and the reservation number of the current day will be displayed.

2. Press **to select the day of the week and the reservation number to be confirmed.**

- Pressing displays the reservation details.
- To change the confirmed reserved settings, select the reservation number and press . The mode is switched to setting mode. Proceed to **Setting mode STEP 4**.

3. Press **to exit the confirmation mode.**

- “ WEEKLY” is displayed on the LCD and WEEKLY TIMER operation is activated.
- The TIMER lamp lights orange.

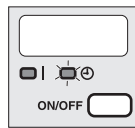

Display

To deactivate WEEKLY TIMER operation

Press **while “ WEEKLY” is displayed on the LCD.**

- “ WEEKLY” disappears from the LCD.
- The TIMER lamp goes off.
- To reactivate the WEEKLY TIMER operation, press again.
- If a reservation deactivated with is activated once again, the last reservation mode will be used.

NOTE

- If not all the reservation settings are reflected, deactivate the WEEKLY TIMER operation once. Then press again to reactivate the WEEKLY TIMER operation.

R4003661

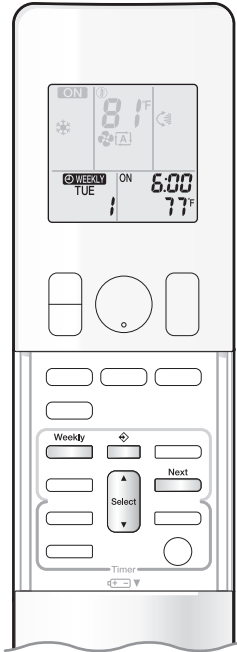

To delete reservations

An individual reservation

1. Press .
 - The day of the week and the reservation number will be displayed.
2. Press to select the day of the week and the reservation number to be deleted.
3. Press .
 - “WEEKLY” and “ON” or “OFF” blink.
4. Press until no icon is displayed.
 - Pressing changes the ON/OFF TIMER mode in sequence.
 - Selecting “blank” will cancel any reservation you may have.



5. Press .
 - The selected reservation will be deleted.
6. Press .
 - If there are still other reservations, WEEKLY TIMER operation will be activated.

Reservations for each day of the week

- This function can be used for deleting reservations for each day of the week.
- It can be used while confirming or setting reservations.

1. Press .
 - The day of the week and the reservation number will be displayed.
2. Press to select the day of the week to be deleted.
3. Hold for about 5 seconds.
 - The reservation of the selected day of the week will be deleted.
4. Press .
 - If there are still other reservations, WEEKLY TIMER operation will be activated.

All reservations

1. Hold for about 5 seconds with the normal display.
 - Be sure to direct the remote controller toward the indoor unit and check for a receiving tone.
 - This operation cannot be used for the WEEKLY TIMER setting display.
 - All reservations will be deleted.

R4003662

2.13 Other Functions

2.13.1 Hot-Start Function

In order to prevent the cold air blast that normally occurs when heating operation is started, the temperature of the indoor heat exchanger is detected, and the airflow is either stopped or significantly weakened resulting in comfortable heating.



Note(s)

The cold air blast is prevented using similar control when defrost control starts or when the thermostat is turned ON.

2.13.2 Signal Receiving Sign

When the indoor unit receives a signal from the remote controller, the unit emits a signal receiving sound.

2.13.3 Indoor Unit ON/OFF Switch

ON/OFF switch is provided on the display of the unit.

- Press **ON/OFF** switch once to start operation. Press once again to stop it.
- **ON/OFF** switch is useful when the remote controller is missing or the battery has run out.

Operation mode	Temperature setting	Airflow rate
AUTO	25°C (77°F)	Automatic

FTX09/12/15

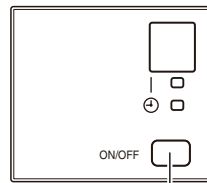

ON/OFF switch

(R21052)

FTX18/24

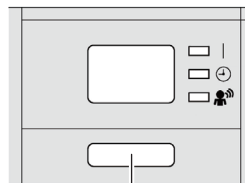

ON/OFF switch

(R13555)

FVXS

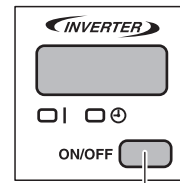

ON/OFF switch

(R23001)

Forced Cooling Operation

Forced cooling operation can be started by pressing **ON/OFF** switch for 5 to 9 seconds while the unit is not operating.

Refer to page 206 for details.



Note(s)

Forced cooling operation is not started if **ON/OFF** switch is pressed for 10 seconds or more.

2.13.4 Auto-restart Function

If a power failure (even a momentary one) occurs during the operation, the system restarts automatically in the same conditions as before when the power supply is restored to the conditions prior to the power failure.



Note

It takes 3 minutes to restart the operation because 3-minute standby function is activated.

3. Functions for FDMQ Series

3.1 Fan Speed Control for Indoor Unit

■ With Wired Remote Controller (BRC1E73)

To change the fan speed, press **Fan Speed** button and select the fan speed from Low/Medium/High/Auto.

- ◆ Auto cannot be selected if the indoor unit does not have Auto Fan speed function.
- ◆ The system may change the fan speed automatically for equipment protection purposes.
- ◆ The system may turn off the fan when the room temperature is satisfied.
- ◆ It is normal for a delay to occur when changing the fan speed.
- ◆ If the Auto is selected for the fan speed, the fan speed varies automatically based on the difference between set temperature and room temperature.

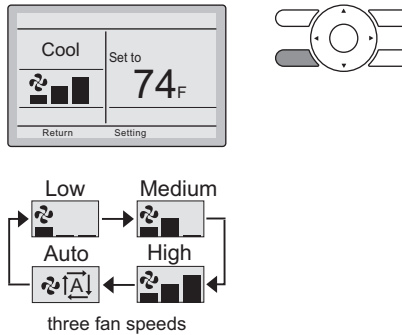

■ With Wireless Remote Controller (BRC082A43)

R4003380

Press **FAN SPEED CONTROL** button.

High, Medium or Low fan speed can be selected.

The microchip may sometimes control the fan speed in order to protect the unit.

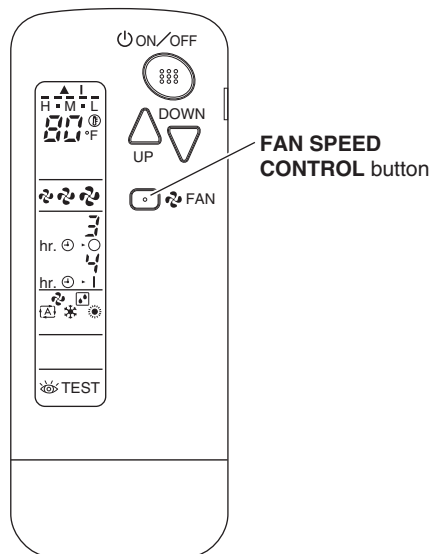

R4003666

3.2 Program Dry Operation

Outline

Program dry operation removes humidity while preventing the room temperature from lowering. Since the microcomputer controls both the temperature and airflow rate, the temperature adjustment and **FAN** setting buttons are inoperable.

Details

The microcomputer automatically sets the temperature and airflow rate. The difference between the room thermistor temperature at start-up and the target temperature is divided into two zones. Then, the unit operates in an appropriate capacity for each zone to maintain the temperature and humidity at a comfortable level.

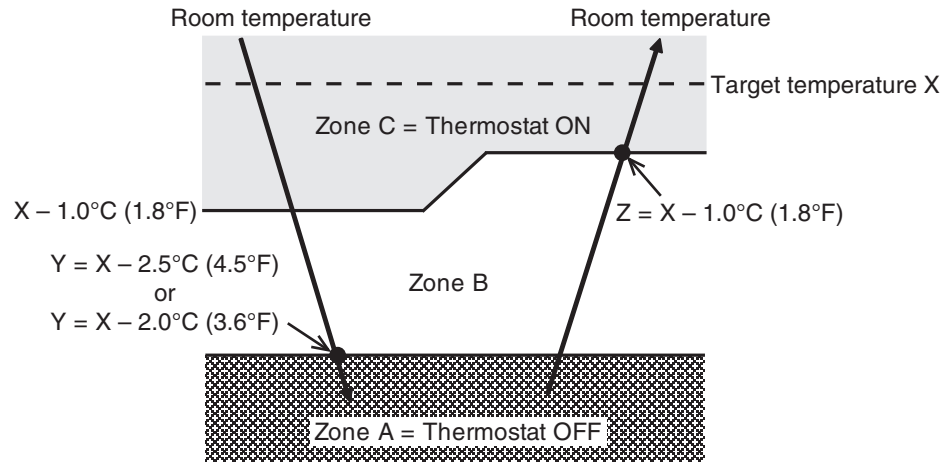

(R23000)

Room thermistor temperature at start-up	Target temperature X	Thermostat OFF point Y	Thermostat ON point Z
24.5°C or more (76.1°F or more)	Room thermistor temperature at start-up	X - 2.5°C (X - 4.5°F)	X - 1.0°C (X - 1.8°F)
16.5 ~ 24°C (61.7 ~ 75.2°F)		X - 2.0°C (X - 3.6°F)	X - 1.0°C (X - 1.8°F)
16°C or less (60.8°F or less)	16°C (60.8°F)	X - 2.0°C (X - 3.6°F)	X - 1.0°C = 15°C (X - 1.8°F = 59°F)

3.3 Clock and Calendar Setting (With BRC1E73)

- 1**

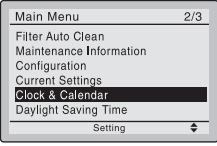
 - Press **Menu/OK** button to display the main menu screen.
 - Press **▼▲** buttons to select **Clock & Calendar** on the main menu screen.

Press **Menu/OK** button to display the clock & calendar screen.

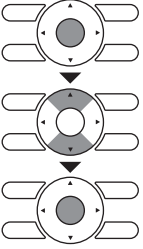

- 2**

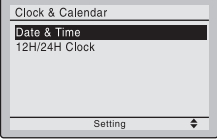
 - Press **▼▲** buttons to select **Date & Time** on the clock & calendar screen.

Press **Menu/OK** button to display the date & time screen.

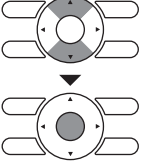

- 3**

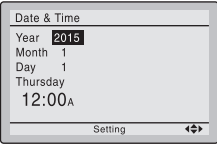
 - Select **Year** with **◀▶** buttons.

Change the year with **▼▲** buttons. Holding down the button causes the number to change continuously.

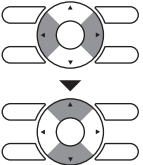

- 4**

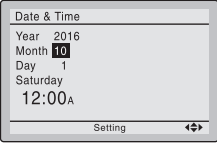
 - Select **Month** with **◀▶** buttons.

Change the month with **▼▲** buttons. Holding down the button causes the number to change continuously.

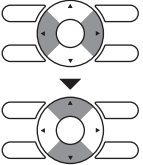

- 5**

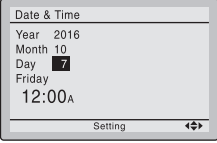
 - Select **Day** with **◀▶** buttons.

Change the day with **▼▲** buttons. Holding down the button causes the number to change continuously. Days of the week change automatically.

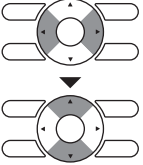

(R24368)

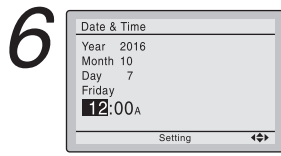

- Select **Hour** with ◀▶ buttons.
- Change the hour with ▼▲ buttons.
- Holding down the button causes the number to change continuously.

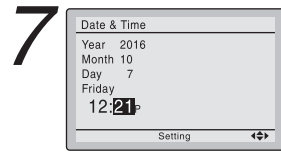
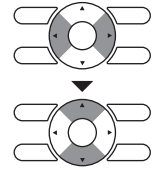

- Select **Minute** with ◀▶ buttons.
- Change the minute with ▼▲ buttons.
- Holding down the button causes the number to change continuously.
- Press **Menu/OK** button.
- The confirmation screen will appear.

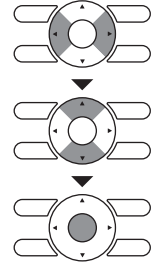

Note:
The date can be set between January 1, 2015 and December 31, 2099.



- Press ◀▶ button to select **Yes** on the confirmation screen.
- Press **Menu/OK** button to confirm the clock and return to the basic screen.

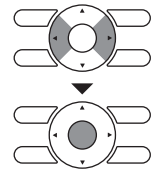

* When setting the schedule, the display returns to the settings screen.

(R24072)

3.4 Schedule Timer Operation (With BRC1E73)

Outline

Day settings are selected from 4 patterns:

- 7 Days
- Weekday/Sat/Sun
- Weekday/Weekend
- Everyday

Up to 5 actions can be set for each day.

Details

Set the startup time and operation stop time.

ON: Startup time, cooling and heating temperature setpoints can be configured.

OFF: Operation stop time, cooling and heating setback temperature setpoints can be configured.

(--: Indicates that the setback function is disabled for this time period.)

__: Indicates that the temperature setpoint and setback temperature setpoint for this time period is not specified. The last active setpoint will be utilized.

■ Setting the schedule

1

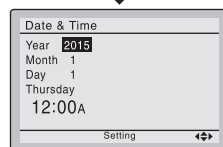
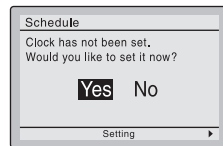
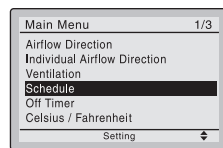

- Press **Menu/OK** button to display the main menu screen.
- Press **▼▲** buttons to select **Schedule**. Press **Menu/OK** button to display the schedule screen.
- Before setting the schedule, the clock must be set.
- If the clock has not been set, a screen like the one on the left will appear. Press **◀▶** buttons to select **Yes** and press **Menu/OK** button.
- The date & time screen will appear.
- Set the current year, month, day, and time.

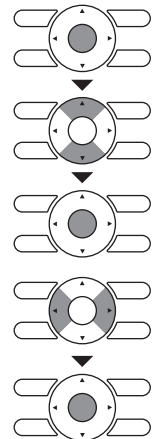

2

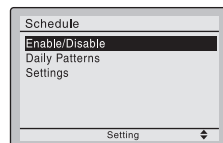

- Press **▼▲** buttons to select the desired function on the schedule screen and press **Menu/OK** button.

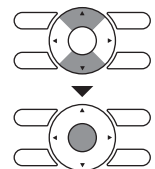

(R24369)

■ Daily Patterns

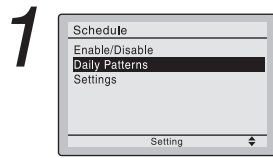

- The schedule screen will appear.
- Press ▼▲ buttons to select **Daily Patterns** on the schedule screen. The daily patterns screen will appear when **Menu/OK** button is pressed.

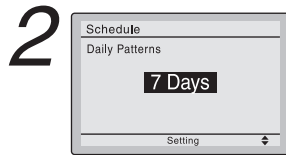
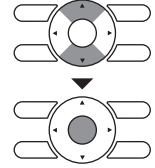

- Press ▼▲ buttons to select **7 Days**, **Weekday/Sat/Sun**, **Weekday/Weekend** or **Everyday** on the daily patterns screen. The confirmation screen will appear when **Menu/OK** button is pressed.

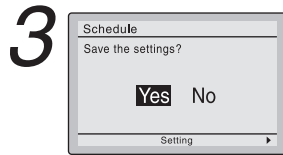
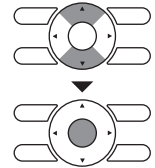

- Press ◀▶ buttons to select **Yes** on the confirmation screen. Pressing **Menu/OK** button enters the daily patterns in the schedule and takes you back to the main menu screen.

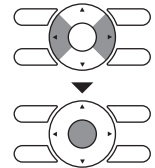

(R24074)

■ Settings

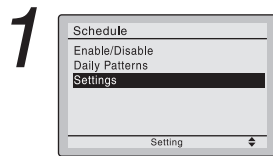

- The schedule screen will appear.
- Press ▼▲ buttons to select **Settings** on the schedule screen. The settings screen will appear when **Menu/OK** button is pressed.

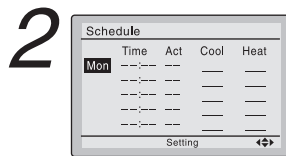
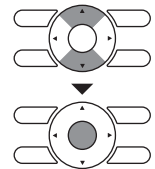

- Press ▼▲ buttons to select the day to be set.
- * It cannot be selected in the case of **EVDY**.

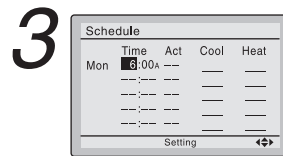
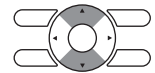

- Input the time for the selected day.
- Press ◀▶ buttons to move the highlighted item and press ▼▲ buttons to input the desired operation start time. Each press of ▼▲ buttons moves the numbers by 1 hour or 1 minute.

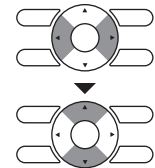

R4003456

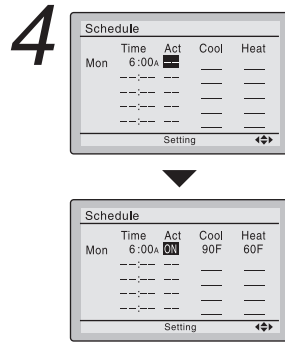

- Press ◀▶ buttons to move the highlighted item and press ▼▲ buttons to configure ON/OFF/-- settings. --, ON, or OFF changes in sequence when ▼▲ buttons are pressed.

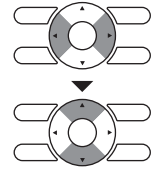

- ON: The temperature setpoints can be configured.
- OFF: The setback temperature setpoints can be configured.
- : The temperature setpoints and setback temperature setpoints become disabled.

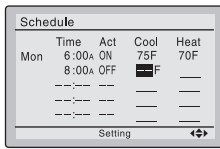

- The cooling and heating temperature setpoints for both ON and OFF (Setback) are configured.

- _: Indicates that the temperature setpoint and setback temperature setpoint for this time period is not specified. The last active setpoint will be utilized.
- : Indicates that the setback function is disabled for this time period.

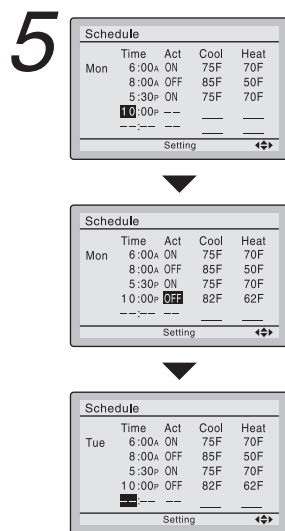

A maximum of five actions per day can be set.

- Press **Menu/OK** button when settings for each day are completed. The confirmation screen will appear.

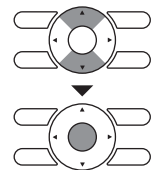

To copy the settings for the previous day, press **Mode** button so that the existing settings will be copied.

Example: The contents for Monday are copied by pressing **Mode** button after selecting Tuesday.

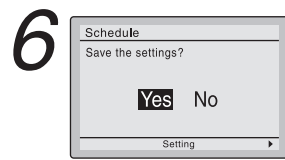
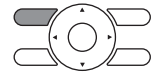

- Press ◀▶ buttons to select **Yes** on the confirmation screen. Pressing **Menu/OK** button confirms the settings for each day and takes you back to the basic screen.

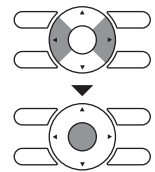

(R24075)

■ Enabling or disabling the schedule

1

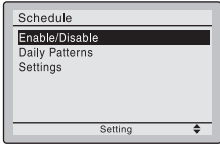

- Display the schedule screen.
- Press ▼▲ buttons to select **Enable / Disable** on the schedule screen. Press **Menu/OK** button to display the enable/disable screen.

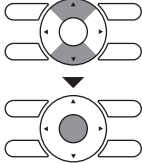

2

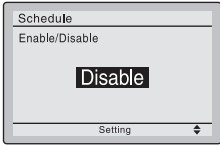

- Press ▼▲ buttons to select **Enable** or **Disable** on the enable/disable screen. Press **Menu/OK** button after selecting the item. The confirmation screen is displayed.

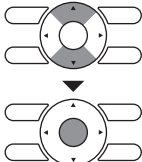

3

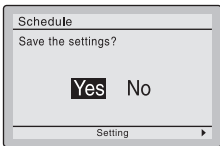

- Press ◀▶ buttons to select **Yes** on the confirmation screen. Pressing **Menu/OK** button confirms the enable/disable setting for the schedule and takes you back to the basic screen.

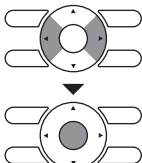

R4003458

3.5 Drain Pump Control

Normal Operation

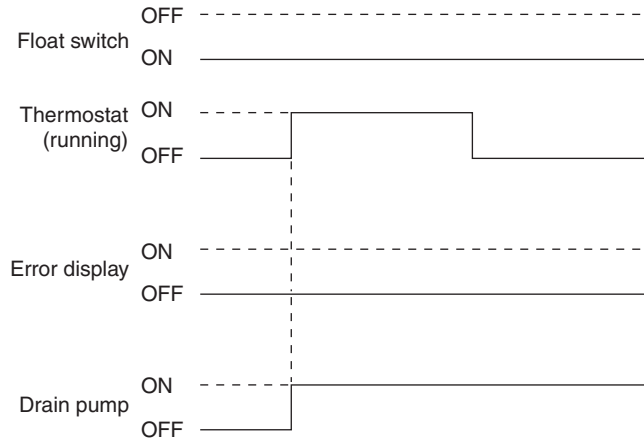

(R24037)

- The float switch is ON in normal operation.
- When cooling operation starts (thermostat ON), the drain pump turns ON simultaneously.
- After the thermostat turns OFF, the drain pump continues to operate.

If Float Switch is OFF with Thermostat ON in Cooling Operation

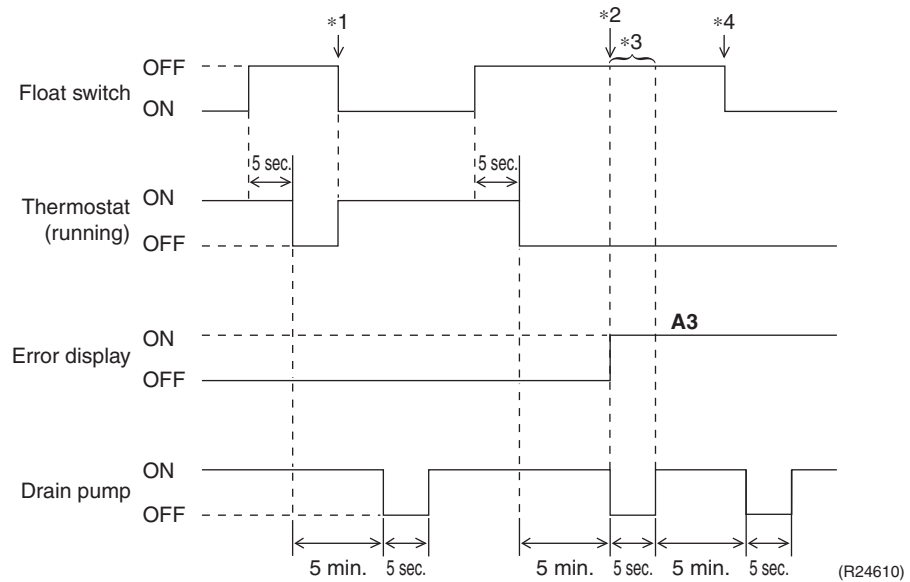

- When the float switch stays OFF for 5 sec., the thermostat turns OFF.
 - After the thermostat turns OFF, the drain pump continues to operate for another 5 minutes.
- *1. If the float switch turns ON again during the residual operation of the drain pump, cooling operation also turns on again (thermostat ON).
 - *2. If the float switch remains OFF even after the residual operation of the drain pump has ended, the error code **A3** is determined.
 - *3. The drain pump turns OFF once residual operation has ended, then turns ON again after 5 seconds.
 - *4. After **A3** is determined and the unit comes to an abnormal stop, the thermostat will remain OFF even if the float switch turns ON again.

If Float Switch is OFF with Thermostat OFF in Cooling Operation

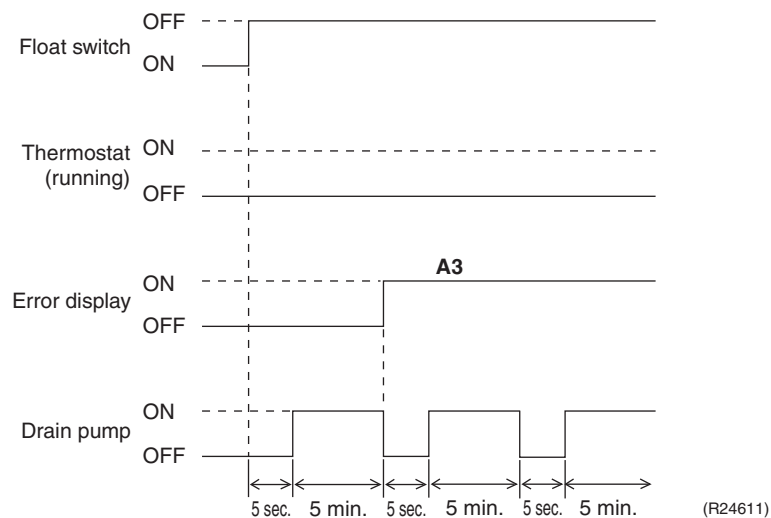

- When the float switch stays OFF for 5 sec., the drain pump turns ON.
- If the float switch remains OFF even after the residual operation of the drain pump has ended, the error code **A3** is determined.
- The drain pump turns OFF once residual operation has ended, then turns ON again after 5 seconds.

If Float Switch Turns ON and OFF Continuously, or Float Switch Turns OFF While AF Displayed

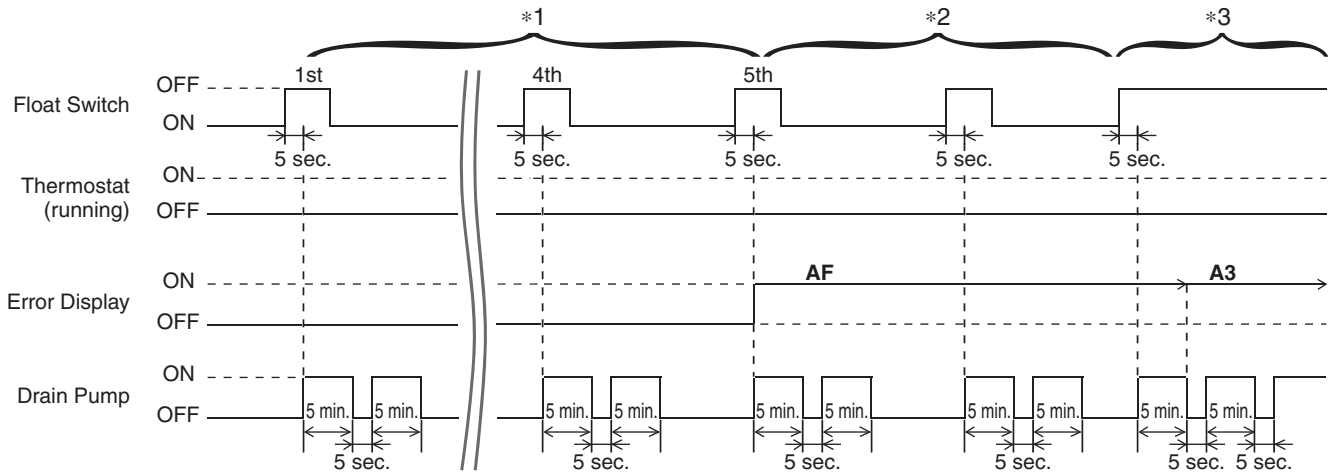

(R24370)

- When the float switch stays OFF for 5 sec., the drain pump turns ON.
 - *1. If the float switch continues to turn OFF and ON 5 times consecutively, it is judged as a drain system error and the error code **AF** is determined.
 - *2. The drain pump continues to turn ON/OFF in accordance with the float switch ON/OFF even after **AF** is determined.
 - *3. While the error code **AF** is displayed, if the float switch remains OFF even after the residual operation of the drain pump has ended, the error code **A3** will be determined.

3.6 Hot Start Control (In Heating Operation Only)

Outline

At startup with thermostat ON or after the completion of defrosting in heating operation, the indoor unit fan is controlled to prevent cold air from blasting out and ensure startup capacity.

Details

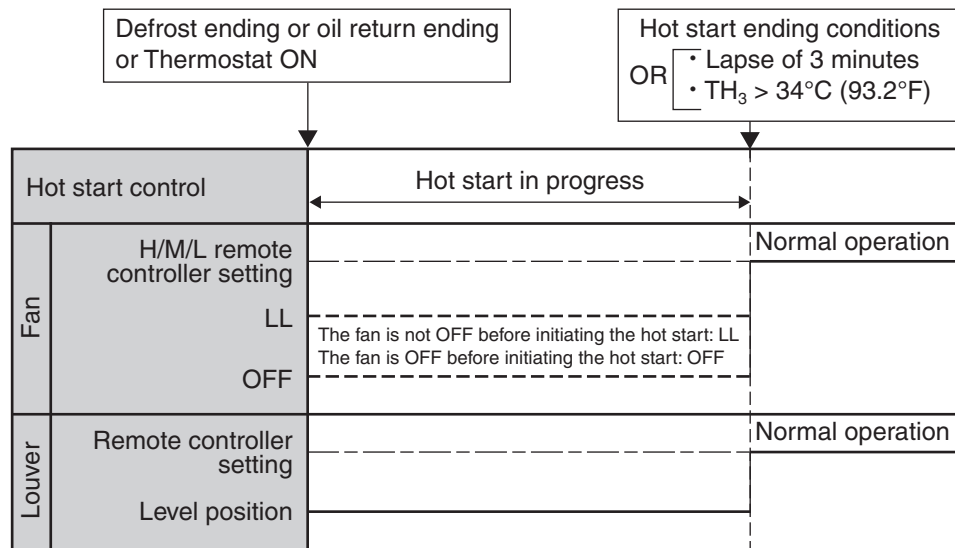

R4003653

TH₃: Temperature detected by the indoor heat exchanger thermistor (R3T)

3.7 Other Functions

3.7.1 Signal Receiving Sign

When the indoor unit receives a signal from the remote controller, the unit emits a signal receiving sound.

3.7.2 Auto-restart Function

If a power failure (even a momentary one) occurs during the operation, the system restarts automatically in the same conditions as before when the power supply is restored to the conditions prior to the power failure.



Note

It takes 3 minutes to restart the operation because 3-minute standby function is activated.

3.7.3 Emergency Operation Switch (With BRC082A43)

Outline

When the wireless remote controller does not work due to battery failure or the absence thereof, use the emergency operation switch.

Details

Start

Press emergency operation switch.

- The indoor unit runs in the previous operation mode.
- The system operates with the previously set airflow direction.

Stop

Press emergency operation switch again.

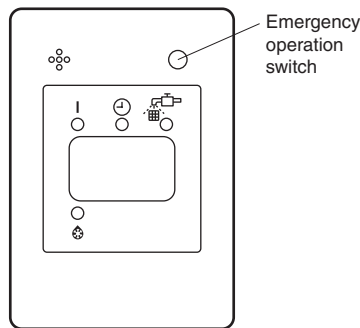

(R24925)

4. Thermistor Functions

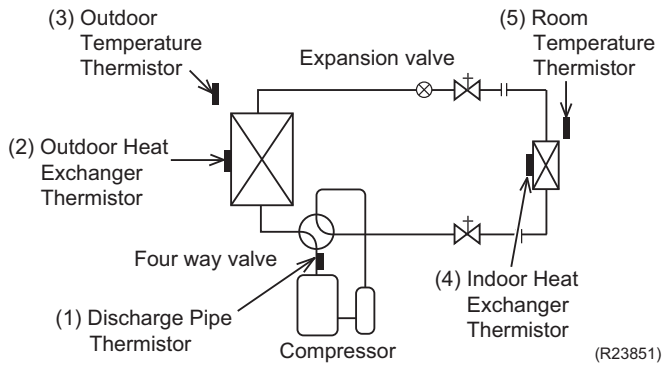

(1) Discharge Pipe Thermistor

- The discharge pipe thermistor is used for controlling discharge pipe temperature. If the discharge pipe temperature (used in place of the inner temperature of the compressor) rises abnormally, the operating frequency becomes lower or the operation halts.
- The discharge pipe thermistor is used for detecting disconnection of the discharge pipe thermistor.

(2) Outdoor Heat Exchanger Thermistor

- The outdoor heat exchanger thermistor is used for controlling the target discharge pipe temperature. The system sets the target discharge pipe temperature according to the outdoor and indoor heat exchanger temperature, and controls the electronic expansion valve opening so that the target discharge pipe temperature can be obtained.
- In cooling operation, the outdoor heat exchanger thermistor is used for detecting the disconnection of the discharge pipe thermistor. When the discharge pipe temperature drops below the outdoor heat exchanger temperature by more than a certain value, the discharge pipe thermistor is judged as disconnected.
- In cooling operation, the outdoor heat exchanger thermistor is used for high pressure protection.

(3) Outdoor Temperature Thermistor

- The outdoor temperature thermistor detects the outdoor air temperature and is used for refrigerant shortage detection, input current control, outdoor fan control, liquid compression protection function, and so on.

(4) Indoor Heat Exchanger Thermistor

- The indoor heat exchanger thermistor is used for controlling the target discharge pipe temperature. The system sets the target discharge pipe temperature according to the outdoor and indoor heat exchanger temperature, and controls the electronic expansion valve opening so that the target discharge pipe temperature can be obtained.
- In cooling operation, the indoor heat exchanger thermistor is used for freeze-up protection control. If the indoor heat exchanger temperature drops abnormally, the operating frequency becomes lower or the operation halts.
- In heating operation, the indoor heat exchanger thermistor is used for detecting the disconnection of the discharge pipe thermistor. When the discharge pipe temperature drops below the indoor heat exchanger temperature by more than a certain value, the discharge pipe thermistor is judged as disconnected.

(5) Room Temperature Thermistor

- The room temperature thermistor detects the room air temperature and is used for controlling the room air temperature.

5. Control Specification

5.1 Mode Hierarchy

Outline

The air conditioner control has normal operation mode, forced operation mode, and power transistor test mode for installation and servicing.

Details

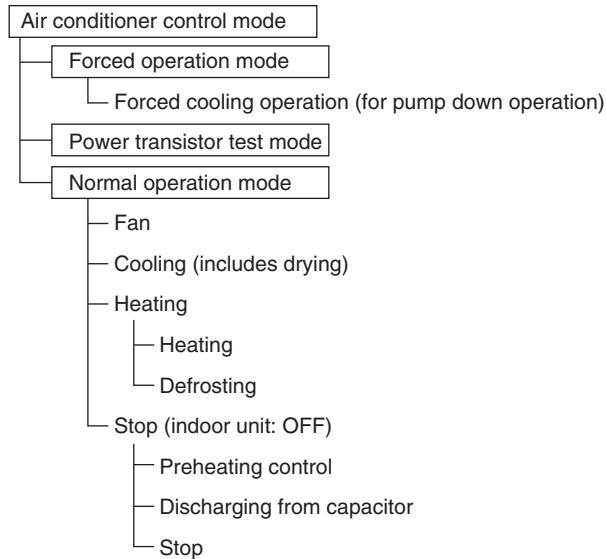

(R22375)

- Unless specified otherwise, dry operation command is regarded as cooling operation.

5.2 Frequency Control

Outline

The compressor frequency is determined according to the difference between the room thermistor temperature and the target temperature.

When the shift of the frequency is less than zero ($\Delta F < 0$) by PI control, the target frequency is used as the command frequency.

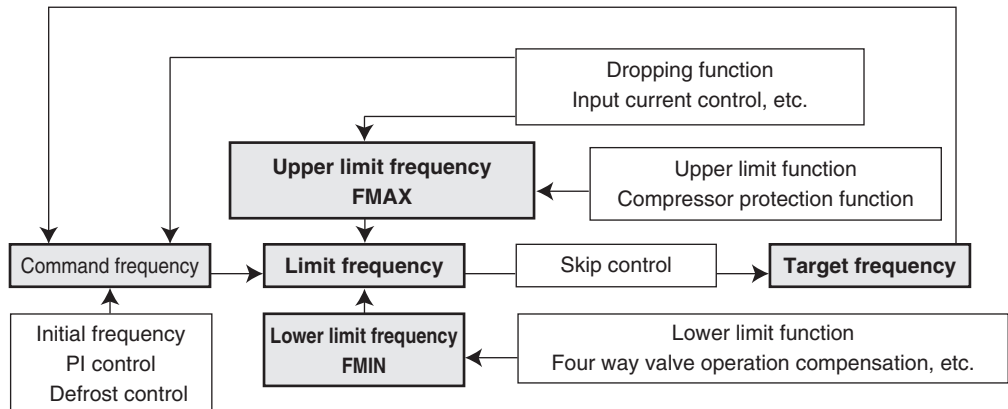

(R18023)

Details

- Determine command frequency**
Command frequency is determined in the following order of priority.
 - (1) Limiting defrost control time
 - (2) Forced cooling

(3) Indoor frequency command

2. **Determine upper limit frequency**

The minimum value is set as an upper limit frequency among the frequency upper limits of the following functions:

Compressor protection, input current, discharge pipe temperature, heating peak-cut, freeze-up protection, defrost control.

3. **Determine lower limit frequency**

The maximum value is set as a lower limit frequency among the frequency lower limits of the following functions:

Four way valve operation compensation, draft prevention, pressure difference upkeep.

4. **Determine prohibited frequency**

There is a certain prohibited frequency such as a power supply frequency.

Initial Frequency

When starting the compressor, the frequency is initialized according to the ΔD value of the indoor unit.

ΔD signal: Indoor frequency command

The difference between the room thermistor temperature and the target temperature is taken as the ΔD value and is used for ΔD signal of frequency command.

Temperature difference	ΔD signal	Temperature difference	ΔD signal	Temperature difference	ΔD signal	Temperature difference	ΔD signal
-2.0°C (-3.6°F)	*OFF	0°C (0°F)	4	2.0°C (3.6°F)	8	4.0°C (7.2°F)	12
-1.5°C (-2.7°F)	1	0.5°C (0.9°F)	5	2.5°C (4.5°F)	9	4.5°C (8.1°F)	13
-1.0°C (-1.8°F)	2	1.0°C (1.8°F)	6	3.0°C (5.4°F)	10	5.0°C (9.0°F)	14
-0.5°C (-0.9°F)	3	1.5°C (2.7°F)	7	3.5°C (6.3°F)	11	5.5°C (9.9°F)	15

* OFF = Thermostat OFF

PI Control

1. **P control**

The ΔD value is calculated in each sampling time (20 seconds), and the frequency is adjusted according to its difference from the frequency previously calculated.

2. **I control**

If the operating frequency does not change for more than a certain fixed time, the frequency is adjusted according to the ΔD value.

When ΔD value is low, the frequency is lowered.

When ΔD value is high, the frequency is increased.

3. **Frequency control when other controls are functioning**

- When frequency is dropping:
Frequency control is carried out only when the frequency drops.
- For limiting lower limit:
Frequency control is carried out only when the frequency rises.

4. **Upper and lower limit of frequency by PI control**

The frequency upper and lower limits are set according to the command of the indoor unit.

When the indoor unit quiet or QUIET OUTDOOR UNIT operation command comes from the indoor unit, the upper limit frequency is lower than the usual setting.

5.3 Controls at Mode Changing/Start-up

5.3.1 Preheating Control

Outline

The inverter operation in open phase starts with the conditions of the outdoor temperature, the discharge pipe temperature, the radiation fin temperature and the preheating command from the indoor unit.

Details

09/15 class

Outdoor temperature $\geq -2.5^{\circ}\text{C}$ (27.5°F) Control A (preheating for normal state)

Outdoor temperature $< -2.5^{\circ}\text{C}$ (27.5°F) Control B (preheating of increased capacity)

Control A

- ON condition
 - Discharge pipe temperature $< 0^{\circ}\text{C}$ (32.0°F)
 - Radiation fin temperature $< 85^{\circ}\text{C}$ (185°F)
- OFF condition
 - Discharge pipe temperature $> 2^{\circ}\text{C}$ (35.6°F)
 - Radiation fin temperature $\geq 90^{\circ}\text{C}$ (194°F)

Control B

- ON condition
 - Discharge pipe temperature $< 10^{\circ}\text{C}$ (50.0°F)
 - Radiation fin temperature $< 85^{\circ}\text{C}$ (185°F)
- OFF condition
 - Discharge pipe temperature $> 12^{\circ}\text{C}$ (53.6°F)
 - Radiation fin temperature $\geq 90^{\circ}\text{C}$ (194°F)

12/18/24 class

- ON condition
 - Discharge pipe temperature $< \text{Outdoor temperature} \times \mathbf{A} + \mathbf{B}$
 - Outdoor temperature $< \mathbf{C}$
 - Radiation fin temperature $< \mathbf{D}$
- OFF condition
 - Discharge pipe temperature $> \text{Outdoor temperature} \times \mathbf{A} + \mathbf{E}$
 - Outdoor temperature $> \mathbf{F}$
 - Radiation fin temperature $\geq \mathbf{G}$

	A	B	C		D		E	F		G	
			(°C)	(°F)	(°C)	(°F)		(°C)	(°F)	(°C)	(°F)
12 class	0/256	10	0	32	85	185	12	2	35.6	90	194
18/24 class	238/256	35	6	42.8	85	185	37	8	46.4	90	194

5.3.2 Four Way Valve Switching

Outline

The four way valve coil is energized/not energized depending on the operation mode.

(Heating: ON, Cooling/Dry/Defrost: OFF)

In order to eliminate the switching sound as the four way valve coil switches from ON to OFF when the heating is stopped, the OFF delay switch of the four way valve is carried out.

Details

OFF delay switch of four way valve

The four way valve coil is energized for 160* seconds after the operation is stopped.

*10 seconds in heating operation when the outdoor temperature is lower than -9°C (15.8°F)

5.3.3 Four Way Valve Operation Compensation

Outline

At the beginning of operation as the four way valve is switched, the pressure difference to activate the four way valve is acquired when the output frequency is higher than a certain fixed frequency, for a certain fixed time.

Details

Starting Conditions

1. When the compressor starts and the four way valve switches from OFF to ON
2. When the four way valve switches from ON to OFF during operation
3. When the compressor starts after resetting
4. When the compressor starts after the fault of four way valve switching

The lower limit of frequency keeps **A** Hz for **B** seconds for any of the conditions above.

When the outdoor temperature is above **C** in heating, the frequency decreases depending on the outdoor temperature.

		09 class		12 class		15 class		18/24 class	
		Cooling	Heating	Cooling	Heating	Cooling	Heating	Cooling	Heating
A (Hz)		40	54	24	34	48		46	48
B (seconds)		60		60		70		60	
C	(°C)	10		10		15		15	
	(°F)	50		50		59		59	

5.3.4 3-Minute Standby

Turning on the compressor is prohibited for 3 minutes after turning off.

The function is not used when defrosting.

5.3.5 Compressor Protection Function

When turning the compressor from OFF to ON, the upper limit of frequency is set as follows.

The function is not used when defrosting.

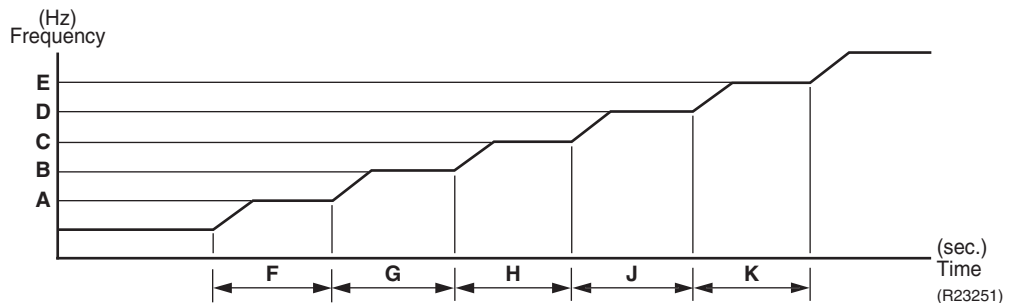

	09 class	12 class	15 class	15 class ★	18/24 class
A (Hz)	40	24	52	35	55/48 ★
B (Hz)	54	34	68	52	65
C (Hz)	72	44	80	62	80
D (Hz)	90	56	98	80	90
E (Hz)	100	78	—	100	100
F (seconds)	180	180	300	1300	240
G (seconds)	420	420	200	250	200
H (seconds)	180	180	460	300	200
J (seconds)	120	120	200	200	120
K (seconds)	400	180	—	120	120

★: Values refer to 15/18/24 class only, when outside temperature is lower than -15°C (5°F).

5.4 Discharge Pipe Temperature Control

Outline

The discharge pipe temperature is used as the internal temperature of the compressor. If the discharge pipe temperature rises above a certain level, the upper limit of frequency is set to keep the discharge pipe temperature from rising further.

Details

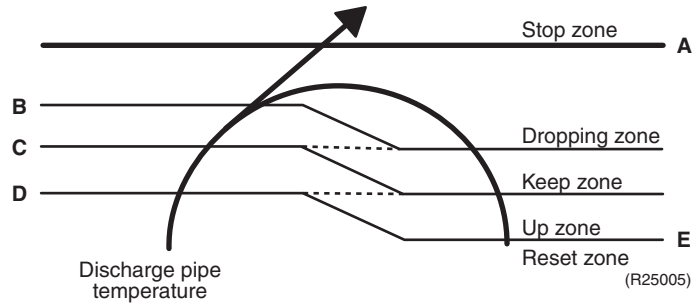

Zone	Control
Stop zone	When the temperature reaches the stop zone, the compressor stops.
Dropping zone	The upper limit of frequency decreases.
Keep zone	The upper limit of frequency is kept.
Up zone	The upper limit of frequency increases.
Reset zone	The upper limit of frequency is canceled.

	09 class		12/18/24 class		15 class	
	(°C)	(°F)	(°C)	(°F)	(°C)	(°F)
A	110	230.0	120	248.0	110	230.0
B	103	217.4	111	231.8	103	217.4
C	98	208.4	109	228.2	101.5	214.7
D	93	199.4	107	224.6	100	212.0
E	88	190.4	107	224.6	95	203.0

5.5 Input Current Control

Outline

The microcomputer calculates the input current while the compressor is running, and sets the frequency upper limit based on the input current.

In case of heat pump models, this control is the upper limit control of the frequency and takes priority over the lower limit control of four way valve operation compensation.

Details

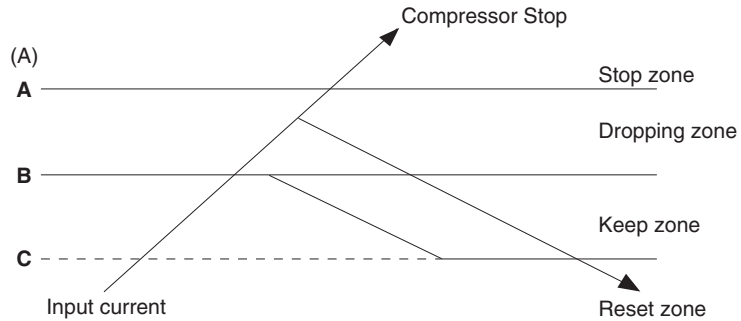

(R23249)

Frequency control in each zone

Stop zone

- After the input current remains in the stop zone for 2.5 seconds, the compressor is stopped.

Dropping zone

- The upper limit of the compressor frequency is defined as operation frequency – 2 Hz.
- After this, the output frequency is lowered by 2 Hz every second until it reaches the keep zone.

Keep zone

- The present maximum frequency goes on.

Reset zone

- Limit of the frequency is canceled.

	09 class		12 class		15 class		18/24 class	
	Cooling	Heating	Cooling	Heating	Cooling	Heating	Cooling	Heating
A (A)	12		13		18		20	
B (A)	7.5	8.5	11.5	12	12	12	16.25	18.25
C (A)	6.5	7.5	10.75	11.25	11	11	15.25	17.25

Limitation of current dropping and stop value according to the outdoor temperature

- ◆ The current drops when outdoor temperature becomes higher than a certain level (depending on the model).

5.6 High Pressure Protection Control

Outline

In order to prevent abnormal high pressures in the system and hence avoiding activation of the high pressure safety device the below control function will be activated.

Details

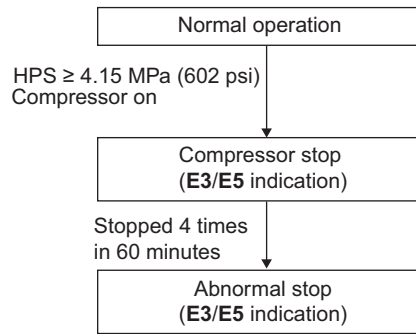
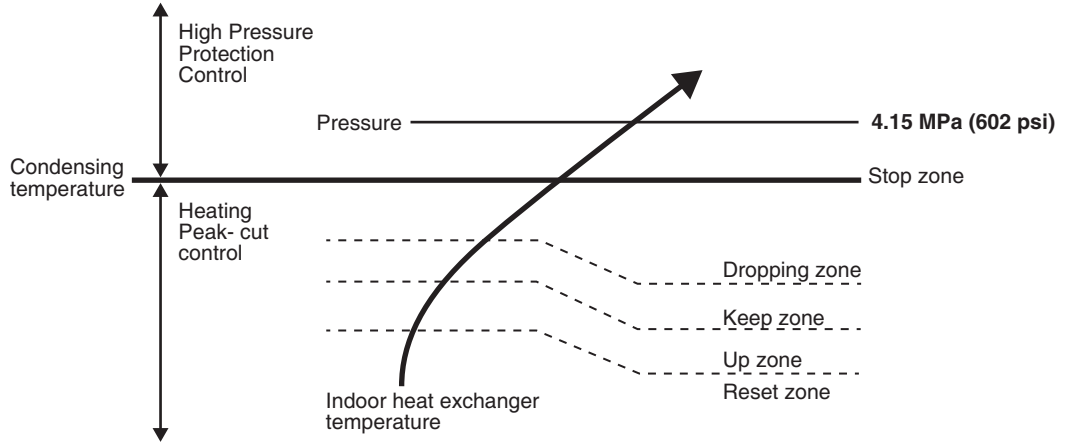

5.7 Freeze-up Protection Control

Outline

During cooling operation, the signal sent from the indoor unit determines the frequency upper limit and prevents freezing of the indoor heat exchanger. The signals from the indoor unit are divided into zones.

Details

■ **FTX, FVXS**

The operating frequency limitation is judged with the indoor heat exchanger temperature.

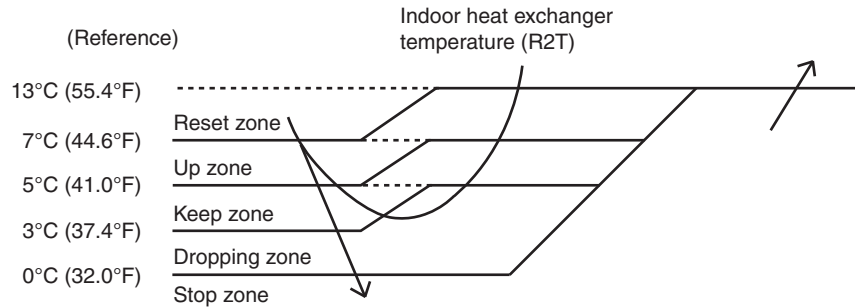

R4003644

■ **FDMQ**

When the freeze-up protection control starts, the compressor stops, the airflow rate is fixed to L tap, and the drain pump turns ON. Conditions for starting and ending are as below.

Starting conditions

The freeze-up protection control starts when any of the following conditions is satisfied.

- The indoor heat exchanger temperature remains at **A** or lower for 1 minute.
- The accumulated time that the indoor heat exchanger temperature remains at **B** or lower reaches 40 minutes.

Accumulated timer clearing condition

- The indoor heat exchanger temperature remains at **C** or higher for 20 minutes.

Ending condition

- The indoor heat exchanger temperature remains at **D** or higher for 10 minutes.

	(°C)	(°F)
A	-5	23.0
B	-1	30.2
C	4	39.2
D	7	44.6

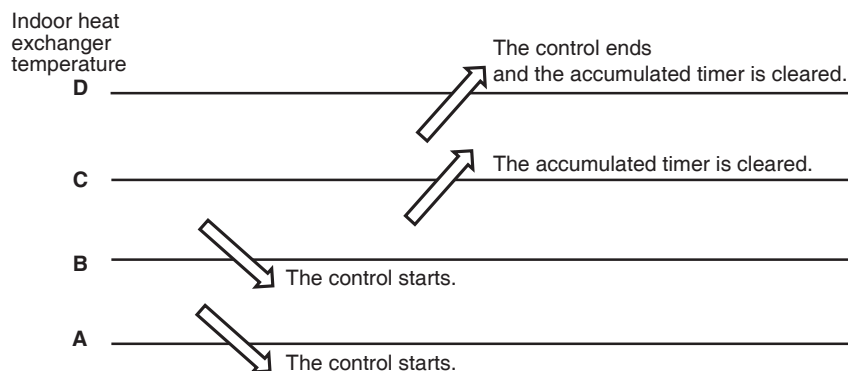

R4003915

5.8 Heating Peak-cut Control

During heating operation, the indoor heat exchanger temperature determines the frequency upper limit to prevent abnormal high pressure.

The operating frequency limitation is judged with the indoor heat exchanger temperature.

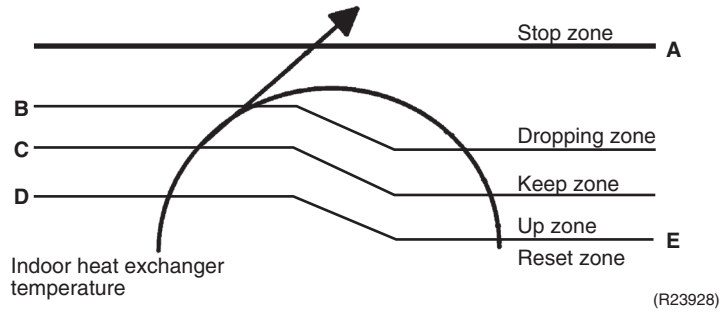

Zone	Control
Stop zone	When the temperature reaches the stop zone, the compressor stops.
Dropping zone	The upper limit of frequency decreases.
Keep zone	The upper limit of frequency is kept.
Up zone	The upper limit of frequency increases.
Reset zone	The upper limit of frequency is canceled.

	09/12 class		15 class		18/24 class	
	(°C)	(°F)	(°C)	(°F)	(°C)	(°F)
A	59	138.2	60	140.0	60	140.0
B ★	55	131.0	54	129.2	56	134.6
C ★	52	125.6	51	123.8	53	129.2
D ★	50	122.0	49	120.2	51	125.6
E	45	113.0	44	111.2	46	116.6

★: The valves might drop when the outdoor temperature is low to protect the compressor.

5.9 Outdoor Fan Control

1. **Fan ON control to cool down the electrical box**
The outdoor fan is turned ON when the electrical box temperature is high while the compressor is OFF.
2. **Fan OFF control during defrosting**
The outdoor fan is turned OFF while defrosting.
3. **Fan OFF delay when stopped**
The outdoor fan is turned OFF 60 ~ 70 seconds after the compressor stops.
4. **Fan speed control for pressure difference upkeep**
The rotation speed of the outdoor fan is controlled for keeping the pressure difference during cooling operation with low outdoor temperature.
 - When the pressure difference is low, the rotation speed of the outdoor fan is reduced.
 - When the pressure difference is high, the rotation speed of the outdoor fan is controlled as well as normal operation.
5. **Fan speed control during forced operation**
The outdoor fan is controlled as well as normal operation during forced operation.
6. **Fan speed control during POWERFUL operation**
The rotation speed of the outdoor fan is increased during POWERFUL operation.
7. **Fan speed control during indoor unit quiet/QUIET OUTDOOR UNIT operation**
The rotation speed of the outdoor fan is reduced by the command of the indoor unit quiet/QUIET OUTDOOR UNIT operation.
8. **Fan ON/OFF control when operation (cooling, heating, dry) starts/stops**
The outdoor fan is turned ON when the operation starts. The outdoor fan is turned OFF when the operation stops.

5.10 Liquid Compression Protection Function

Outline

The compressor stops according to the outdoor temperature for protection.

Details

Operation stops depending on the outdoor temperature.

The compressor turns off under the conditions that the system is in cooling operation and the outdoor temperature is below 0°C (32°F).

However, the operating range can be extended to the lowest temperature of -20°C (-4°F) by changing facility setting. Refer to page 228 for details of facility setting.

5.11 Defrost Control

Outline

Defrosting is carried out by the cooling cycle (reverse cycle). The defrosting time or outdoor heat exchanger temperature must be more than a certain value to finish defrosting.

Details

Conditions for Starting Defrost

- The starting conditions are determined with the outdoor temperature and the outdoor heat exchanger temperature.
- The system is in heating operation.
- The compressor operates for 6 minutes.
- More than **A** minutes (depending on the duration of the previous defrost control) of accumulated time have passed since the start of the operation, or ending the previous defrosting.

Conditions for Canceling Defrost

The judgment is made with the outdoor heat exchanger temperature (**B**).

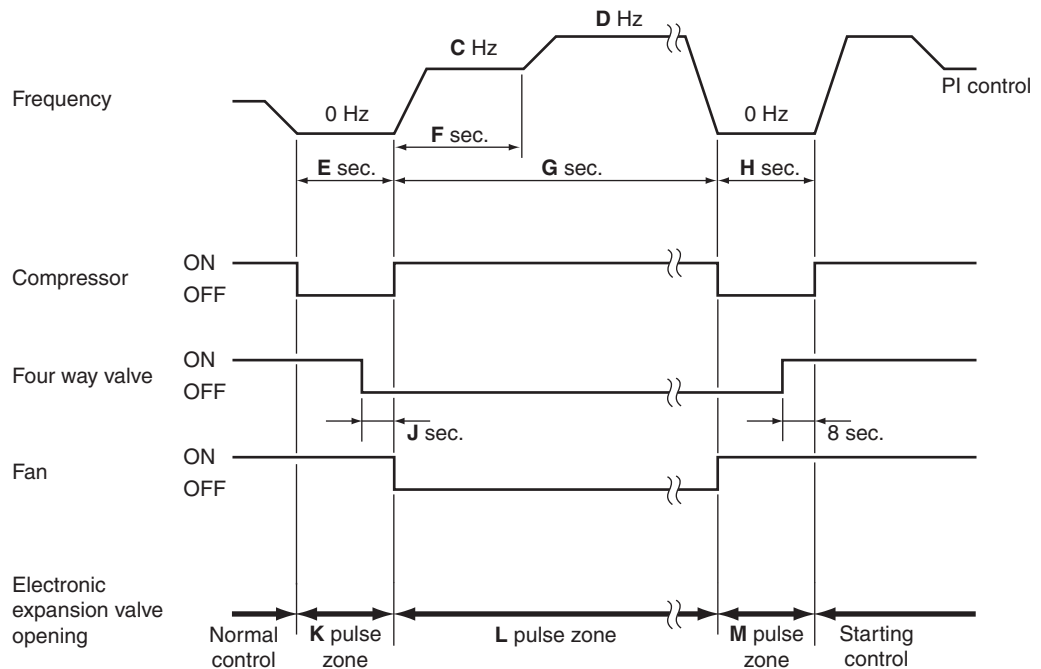

(R21661)

	09 class	12 class	15 class	18/24 class
A (minute)	20 ~ 25	20 ~ 25	44	15 ~ 25
B	(°C)	2 ~ 20	2 ~ 20	6 ~ 12
	(°F)	35.6 ~ 68.0	35.6 ~ 68.0	42.8 ~ 86.0
C (Hz)	64	40	48	48
D (Hz)	64	40	70	54
E (seconds)	40	40	60	60
F (seconds)	60	60	60	120
G (seconds)	510	510	340	340
H (seconds)	50	50	90	60
J (seconds)	8	8	5	8
K (pulse)	400	400	450	450
L (pulse)	300	300	300 ~ 450	400
M (pulse)	350	350	200	450

5.12 Electronic Expansion Valve Control

Outline

The following items are included in the electronic expansion valve control.

Electronic expansion valve is fully closed

1. Electronic expansion valve is fully closed when turning on the power.
2. Pressure equalizing control

Open Control

1. Electronic expansion valve control when starting operation
2. Electronic expansion valve control when the frequency changes
3. Electronic expansion valve control for defrosting
4. Electronic expansion valve control when the discharge pipe temperature is abnormally high
5. Electronic expansion valve control when the discharge pipe thermistor is disconnected

Feedback Control

Target discharge pipe temperature control

Details

The followings are the examples of electronic expansion valve control for each operation mode.

<div style="text-align: center;">Status</div> <div style="text-align: center;">Control</div>	Power on ; Compressor stop	Operation start	Frequency change under starting control	During target discharge pipe temperature control	Frequency change under target discharge pipe temperature control	Discharge pipe thermistor disconnection	Frequency change under discharge pipe thermistor disconnection control	During defrost control
Starting operation control	—	●	—	—	—	—	—	—
Control when the frequency changes	—	—	●	—	●	—	—	—
Target discharge pipe temperature control	—	—	—	●	—	—	—	—
Discharge pipe thermistor disconnection control	—	—	—	—	—	●	●	—
High discharge pipe temperature control	—	●	●	●	●	—	—	—
Defrost control (heating only)	—	—	—	—	—	—	—	●
Pressure equalizing control	●	—	—	—	—	—	—	—
Opening limit control	—	●	●	●	●	●	●	—

- : Available
- : Not available

R4003560

5.12.1 Initialization as Power Supply On

The electronic expansion valve is initialized (fully closed) when the power is turned on. Then, the valve opening position is set and the pressure is equalized.

5.12.2 Pressure Equalizing Control

When the compressor is stopped, the pressure equalizing control is activated. The electronic expansion valve opens, and develops the pressure equalization.

5.12.3 Opening Limit Control

The maximum and minimum opening of the electronic expansion valve are limited.

	09/12 class	15 class	18/24 class
Maximum opening (pulse)	470	480	490
Minimum opening (pulse)	32	52	52

The electronic expansion valve is fully closed when cooling operation stops, and is opened at a fixed degree during defrosting.

5.12.4 Starting Operation Control

The electronic expansion valve opening is controlled when the operation starts, thus preventing superheating or liquid compression.

5.12.5 Control when the Frequency Changes

When the target discharge pipe temperature control is active, if the target frequency changes to a specified value in a certain time period, the target discharge pipe temperature control is canceled and the target opening of the electronic expansion valve is changed according to the frequency shift.

5.12.6 High Discharge Pipe Temperature Control

When the compressor is operating, if the discharge pipe temperature exceeds a certain value, the electronic expansion valve opens and the refrigerant runs to the low pressure side.

This procedure lowers the discharge pipe temperature.

5.12.7 Discharge Pipe Thermistor Disconnection Control

Outline

The disconnection of the discharge pipe thermistor is detected by comparing the discharge pipe temperature with the condensation temperature. If the discharge pipe thermistor is disconnected, the electronic expansion valve opens according to the outdoor temperature and the operation frequency, operates for a specified time, and then stops.

After 3 minutes, the operation restarts and checks if the discharge pipe thermistor is disconnected. If the discharge pipe thermistor is disconnected, the system stops after operating for a specified time.

If the disconnection is detected repeatedly, the system is shut down. When the compressor runs for 60 minutes without any error, the error counter is reset.

Details

Determining thermistor disconnection

When the starting control finishes, the detection timer for disconnection of the discharge pipe thermistor (**A** seconds) starts. When the timer is over, the following adjustment is made.

1. When the operation mode is cooling

When the following condition is fulfilled, the discharge pipe thermistor disconnection is ascertained.

Discharge pipe temperature $+6^{\circ}\text{C}$ ($+10.8^{\circ}\text{F}$) $<$ outdoor heat exchanger temperature

2. When the operation mode is heating

When the following condition is fulfilled, the discharge pipe thermistor disconnection is ascertained.

Discharge pipe temperature $+6^{\circ}\text{C}$ ($+10.8^{\circ}\text{F}$) $<$ indoor heat exchanger temperature

	A (seconds)		
	09/12 class	15 class	18/24 class
Other than below	720	540	1020
Heating (When outdoor temperature is below -15°C (5°F))	1200	1800	1800

When the thermistor is disconnected

When the disconnection is ascertained, the compressor continues operation for 9 minutes and then stops.

If the compressor stops repeatedly, the system is shut down.

5.12.8 Target Discharge Pipe Temperature Control

The target discharge pipe temperature is obtained from the indoor and outdoor heat exchanger temperature, and the electronic expansion valve opening is adjusted so that the actual discharge pipe temperature becomes close to the target discharge pipe temperature. (Indirect SH (superheating) control using the discharge pipe temperature)

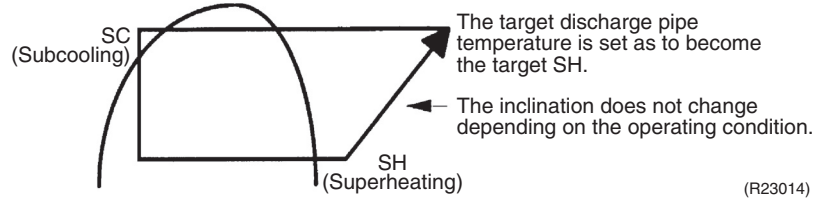

(R23014)

The electronic expansion valve opening and the target discharge pipe temperature are adjusted every **A** seconds. The opening degree of the electronic expansion valve is adjusted by the following.

- Target discharge pipe temperature
- Actual discharge pipe temperature
- Previous discharge pipe temperature

	09/12/15 class	18/24 class
A (seconds)	10 ~ 30★	20

★ The time depends on the opening of the electronic expansion valve.

5.13 Malfunctions

5.13.1 Sensor Malfunction Detection

Sensor malfunction can be detected in the following thermistor:

1. Outdoor heat exchanger thermistor
2. Discharge pipe thermistor
3. Radiation fin thermistor
4. Outdoor temperature thermistor

5.13.2 Detection of Overcurrent and Overload

Outline

An excessive output current is detected and the OL temperature is observed to protect the compressor.

Details

- If the OL (compressor head) temperature exceeds 120 ~ 130°C (248 ~ 266°F) (depending on the model), the system shuts down the compressor.
- If the inverter current exceeds 12.0 ~ 20.0 A (depending on the model), the system shuts down the compressor.
The upper limit of the current decreases when the outdoor temperature exceeds a certain level.

Part 5

Remote Controller

1. Applicable Remote Controller	92
2. ARC466A21	93
3. ARC466A37	95
4. ARC480A8	97
5. BRC082A43	98
6. BRC944B2	100
7. BRC1E73	101

1. Applicable Remote Controller

Type	Model Name	Wireless R/C	Reference Page	Wired R/C	Reference Page
Wall Mounted	FTX09WMVJU9	ARC480A8	97	BRC944B2 (option)	100
	FTX12WMVJU9				
	FTX15WMVJU9				
	FTX18WVJU9	ARC466A37	95		
	FTX24WVJU9				
Floor Standing	FVXS09WVJU9	ARC466A21	93	—	—
	FVXS12WVJU9				
	FVXS15WVJU9				
Duct Concealed	FDMQ12WVJU9	BRC082A43	98	BRC1E73	101
	FDMQ18WVJU9				
	FDMQ24WVJU9				



Note

Refer to the operation manual of applicable model for details. You can download operation manuals from Daikin Business Portal:

Daikin Business Portal → Document Search → Item Category → Installation/Operation Manual
(URL: https://global1d.daikin.com/business_portal/login/)

2. ARC466A21

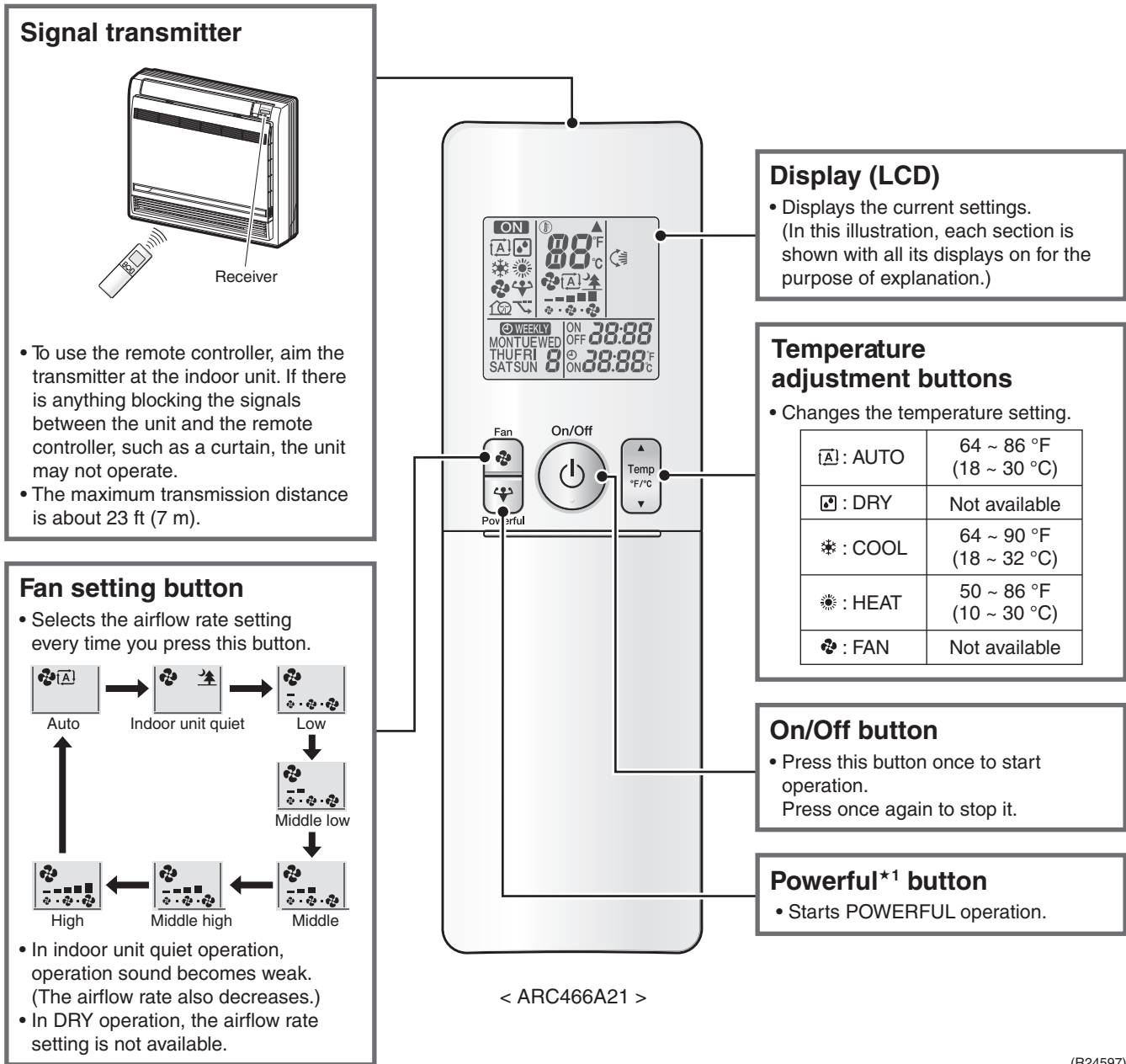

(R24597)



Reference

Refer to the following pages for details.

★1 POWERFUL operation P.55

Open the Front Cover

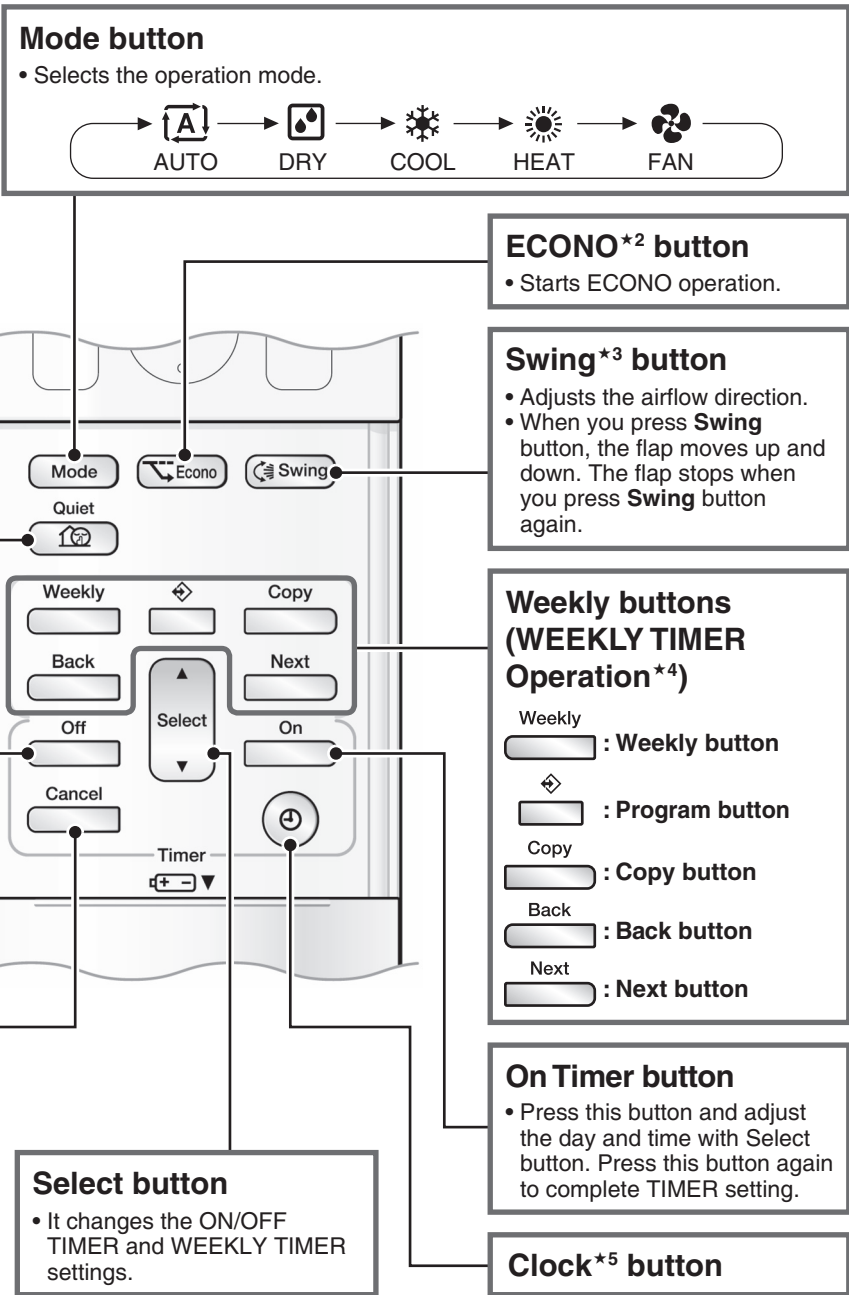
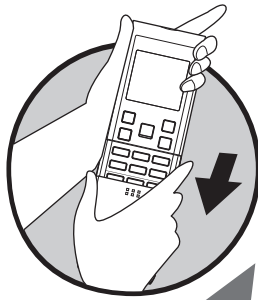

(R25077)



Reference

Refer to the following pages for details.

- ★2 ECONO operation P.53
- ★3 Auto-swing P.44
- ★4 WEEKLY TIMER operation P.57
- ★5 Clock setting P.56

3. ARC466A37

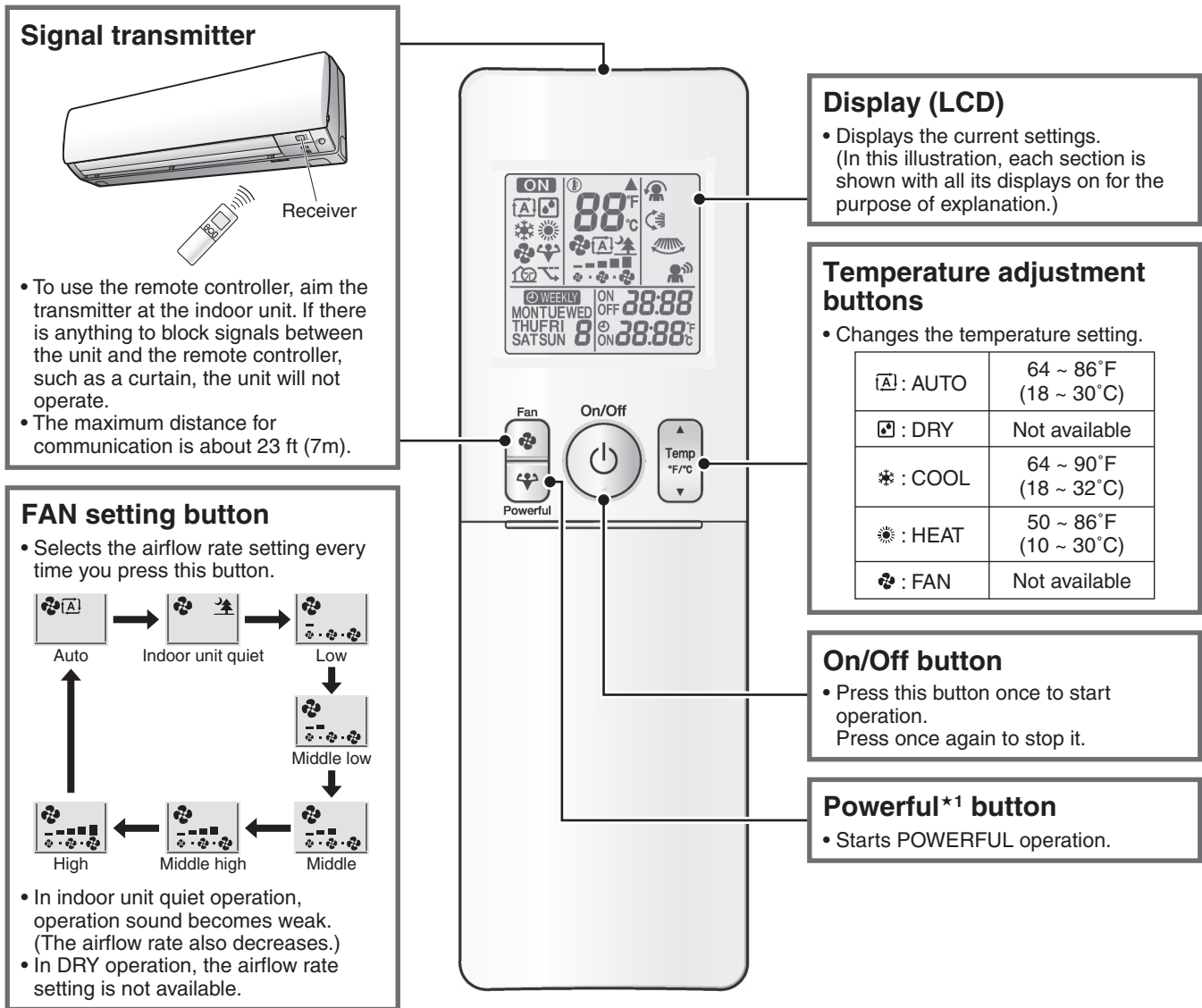

< ARC466A37 >

R5000260



Reference

Refer to the following pages for details.

★1 POWERFUL operation

P.55

Open the Front Cover

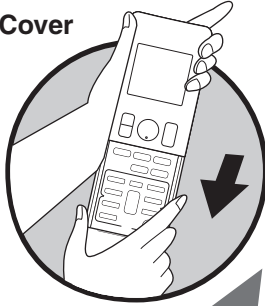

Mode button

• Selects the operation mode.

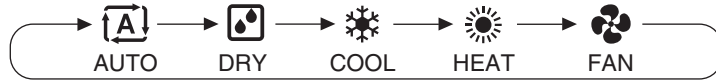

Comfort/Sensor button (COMFORT AIRFLOW Operation^{*2} /INTELLIGENT EYE Operation^{*3})

• Every time you press **Comfort/Sensor** button, the setting changes in the following order.

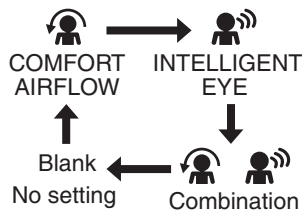

Off Timer button (NIGHT SET mode)

• Press this button and adjust the day and time with **Select** button.
Press this button again to complete **TIMER** setting.

Timer Cancel button

• Cancels the timer setting.
• It cannot be used for the **WEEKLY TIMER** operation.

Select button

• Changes the **ON/OFF TIMER** and **WEEKLY TIMER** settings.

Clock^{*7} button

On Timer button

• Press this button and adjust the day and time with **Select** button.
Press this button again to complete **TIMER** setting.

Econo^{*4}/Quiet button

• Every time you press **Econo/Quiet** button, the setting changes in the following order.

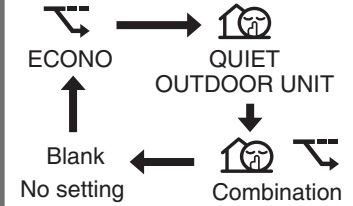

• **QUIET OUTDOOR UNIT** operation is not available in **FAN** and **DRY** operation.
• **QUIET OUTDOOR UNIT** operation and **ECONO** operation cannot be used at the same time with **POWERFUL** operation. Priority is given to the function you pressed last.

Swing^{*5} buttons

• Adjusts the airflow direction.
• When you press **Swing** button, the flap moves up and down, or (and) the louver moves right and left. The flap (louver) stops when you press **Swing** button again.

Weekly buttons (WEEKLY TIMER Operation^{*6})

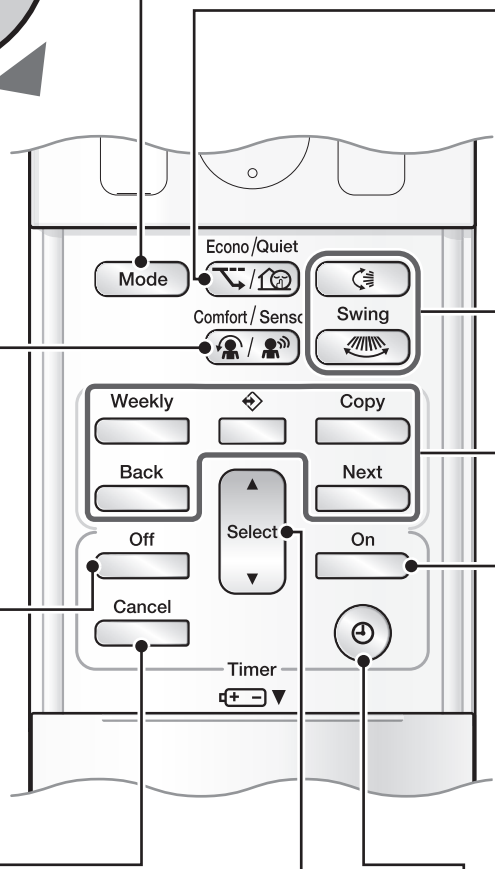
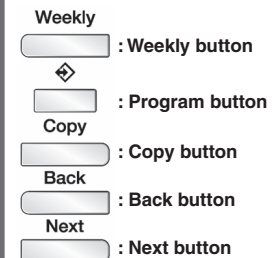

Reference Refer to the following pages for details.

- ★2 COMFORT AIRFLOW operation P.47
- ★3 INTELLIGENT EYE operation P.54
- ★4 ECONO operation P.53

- P.47
- P.54
- P.53

- ★5 Auto-swing P.44
- ★6 WEEKLY TIMER operation P.57
- ★7 Clock setting P.56

R5000261

4. ARC480A8

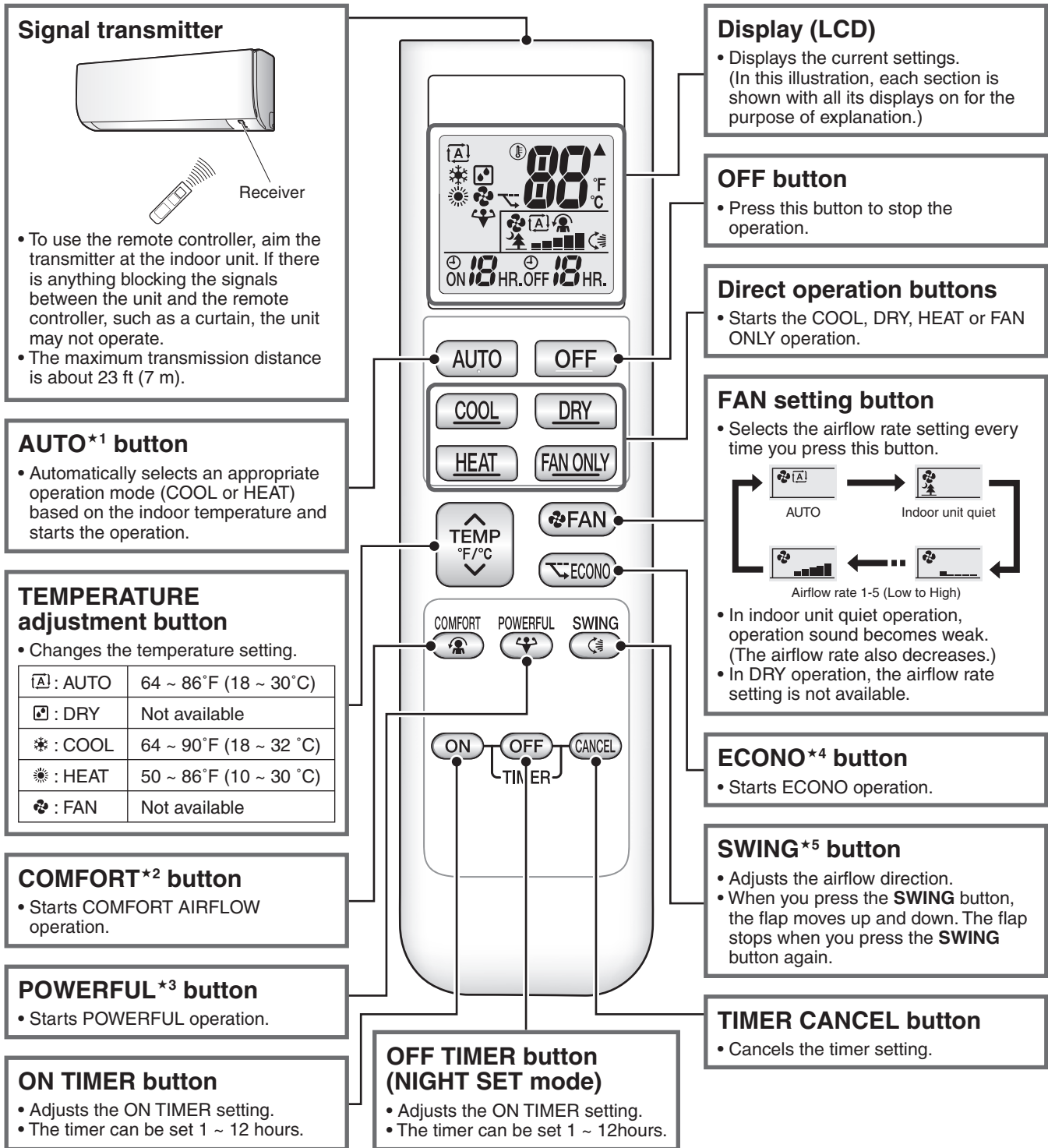

< ARC480A8 >

R5000259

Reference Refer to the following pages for details.

- ★1 Automatic cooling/heating changeover P.50
- ★2 COMFORT AIRFLOW operation P.47
- ★3 POWERFUL operation P.55
- ★4 ECONO operation P.53
- ★5 Auto-swing P.44

5. BRC082A43

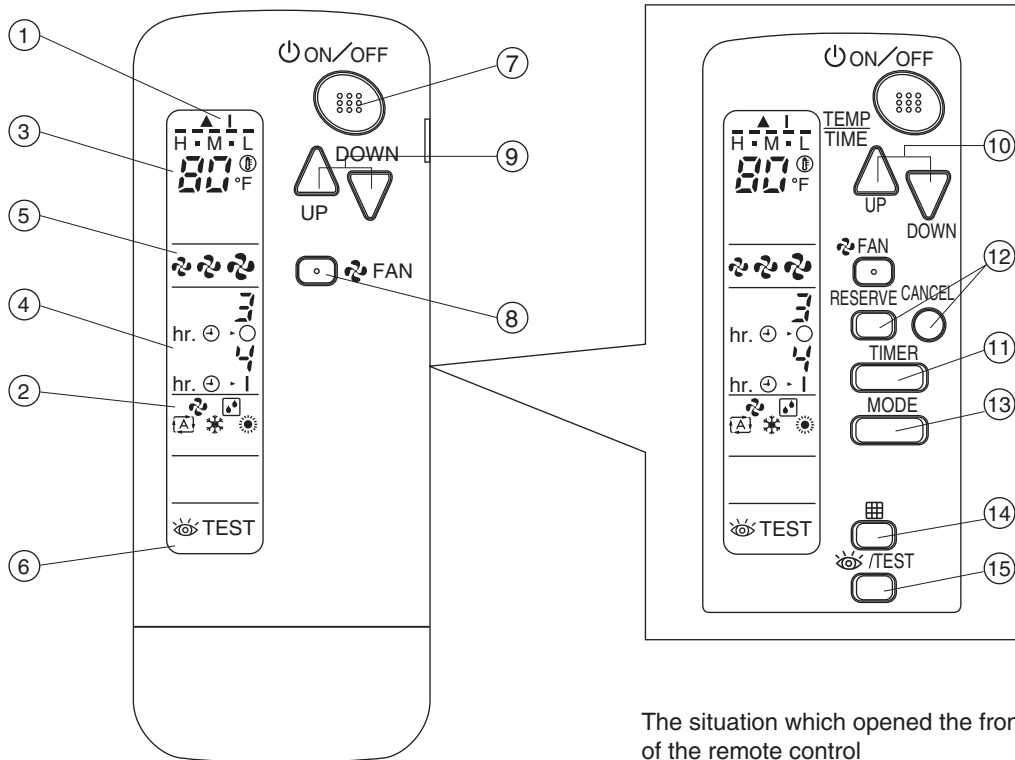





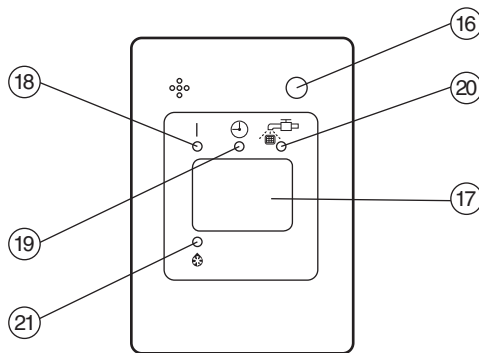







The situation which opened the front cover of the remote control

(R25006)



(R25007)

1	DISPLAY “▲” “I” (SIGNAL TRANSMISSION) This lights up when a signal is being transmitted.
2	DISPLAY “” “” “” “” “” (SET TEMPERATURE) This display shows the set temperature.
4	DISPLAY “ hr.  hr.  hr. ” (PROGRAMMED TIME) This display shows PROGRAMMED TIME of the system start or stop.
5	DISPLAY “” “” “” (FAN SPEED) This display shows the set fan speed.
6	DISPLAY “ TEST” (INSPECTION/ TEST OPERATION) When the INSPECTION/TEST OPERATION BUTTON is pressed, the display shows the system mode is in.
7	ON/OFF BUTTON Press the button and the system will start. Press the button again and the system will stop.
8	FAN SPEED CONTROL BUTTON Press this button to select the fan speed (HIGH, MEDIUM or LOW) of your choice.
9	TEMPERATURE SETTING BUTTON Use this button for SETTING TEMPERATURE. (Operates with the front cover of the remote controller closed.)
10	PROGRAMMING TIMER BUTTON Use this button for programming “START and/or STOP” time. (Operates with the front cover of the remote controller opened.)

11	TIMER MODE START/STOP BUTTON Use this button for TIMER MODE setting.
12	TIMER RESERVE/CANCEL BUTTON Use this button to end timer setting procedure.
13	OPERATION MODE SELECTOR BUTTON Press this button to select OPERATION MODE.
14	FILTER SIGN RESET BUTTON Refer to the section of MAINTENANCE in the operation manual attached to the indoor unit.
15	INSPECTION/TEST OPERATION BUTTON This button is pressed for inspection or test operation. Do not use for normal operation.
16	EMERGENCY OPERATION SWITCH This switch is readily used if the remote controller does not work.
17	RECEIVER This receives the signals from the remote controller.
18	OPERATING INDICATOR LAMP (Red) This lamp stays lit while the air conditioner runs. It flashes when the unit is in trouble.
19	TIMER INDICATOR LAMP (Green) This lamp stays lit while the timer is set.
20	AIR FILTER CLEANING TIME INDICATOR LAMP (Red) Lights up when it is time to clean the air filter.
21	DEFROST LAMP (Orange) Lights up when the defrosting operation has started. (For cooling only type this lamp does not turn on.)

6. BRC944B2

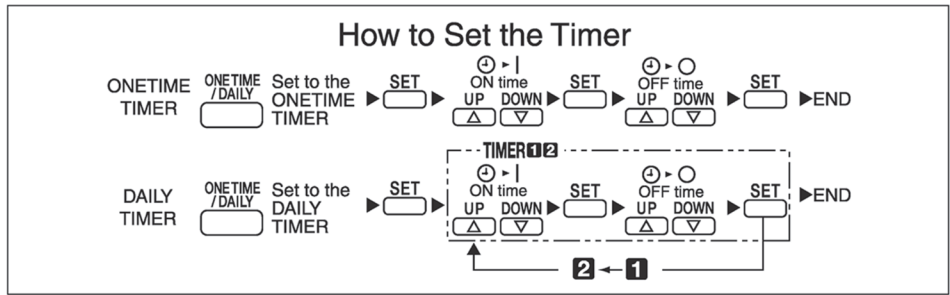
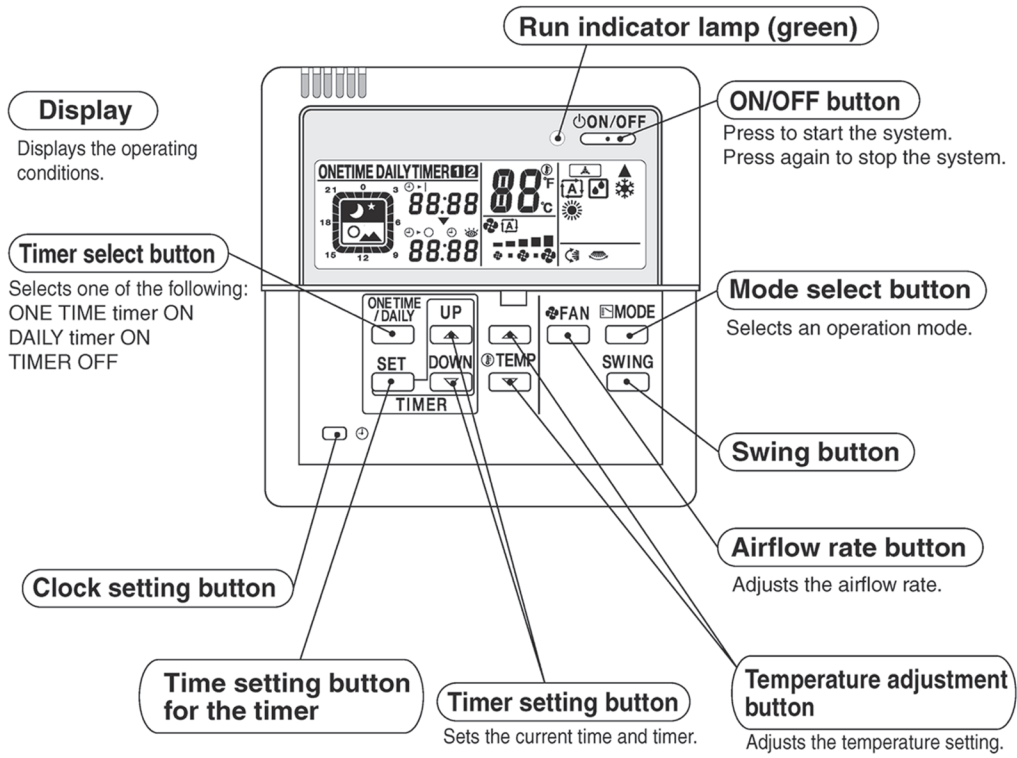

R5000214



Caution

This remote controller cannot be used together with a standard wireless remote controller. Otherwise, what appears on this remote controller's display may fail to correspond to actual operating conditions.

7. BRC1E73

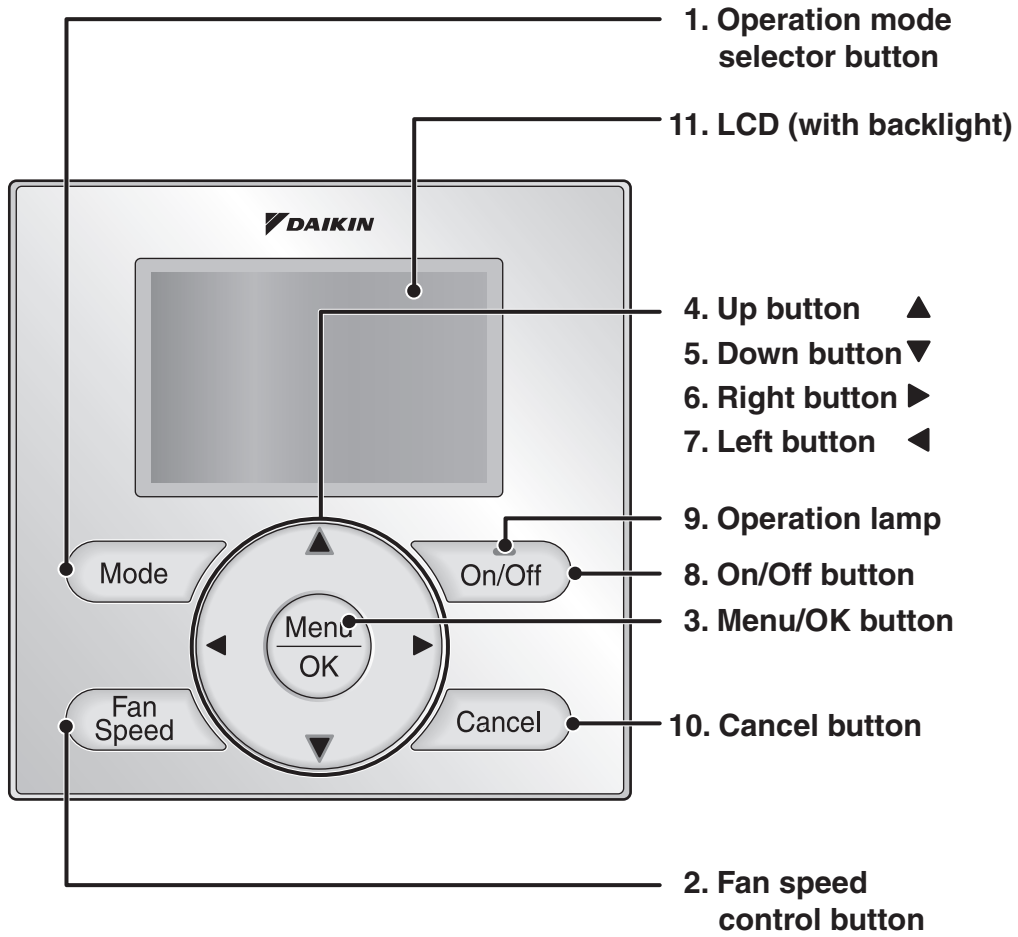

1. Operation mode selector button

- Press this button to select the operation mode of your preference.
* Available modes vary with the indoor unit model.

2. Fan speed control button

- Press this button to select the fan speed of your preference.
* Available fan speeds vary with the indoor unit model.

3. Menu/OK button

- Used to enter the main menu.
- Used to enter the selected item.

4. Up button ▲

- Used to raise the setpoint.
- The item above the current selection will be highlighted.
(The highlighted items will be scrolled continuously when the button is continuously pressed.)
- Used to change the selected item.

5. Down button ▼

- Used to lower the setpoint.
- The item below the current selection will be highlighted.
(The highlighted items will be scrolled continuously when the button is continuously pressed.)
- Used to change the selected item.

6. Right button ►

- Used to highlight the next items on the right-hand side.
- Each screen is scrolled in the right-hand direction.

7. Left button ◀

- Used to highlight the next items on the left-hand side.
- Each screen is scrolled in the left-hand direction.

8. On/Off button

- Press this button and system will start.
- Press this button again to stop the system.

9. Operation lamp

- This lamp illuminates solid green during normal operation.
- This lamp flashes if an error occurs.

10. Cancel button

- Used to return to the previous screen.

11. LCD (with backlight)

- The backlight will be illuminated for approximately 30 seconds by pressing any button.
- If two remote controllers are used to control a single indoor unit, only the controller accessed first will have backlight functionality.

Liquid Crystal Display

- Three types of display mode (Standard, Detailed and Simple) are available.
- Standard display is set by default.
- Detailed and Simple displays can be selected in the main menu.

Standard display

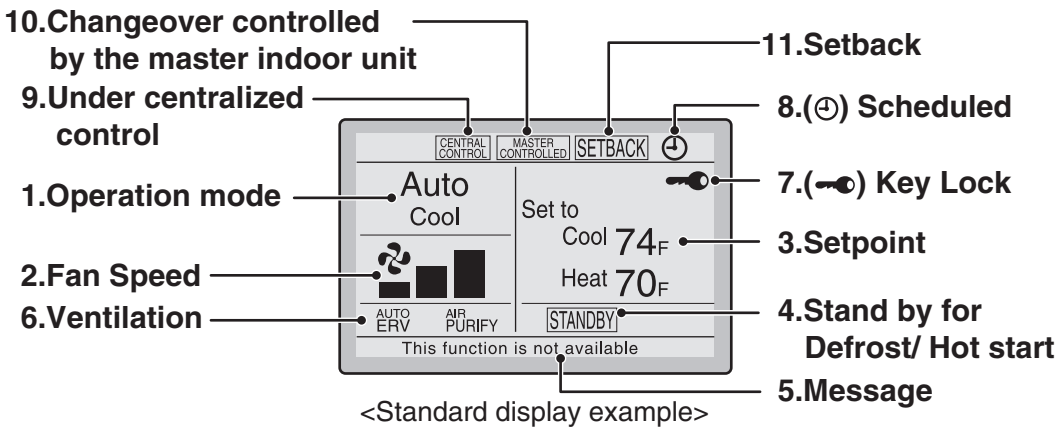

Detailed display

- The airflow direction, clock, and selectable item appear on Detailed display screen in addition to the items appearing on Standard display.

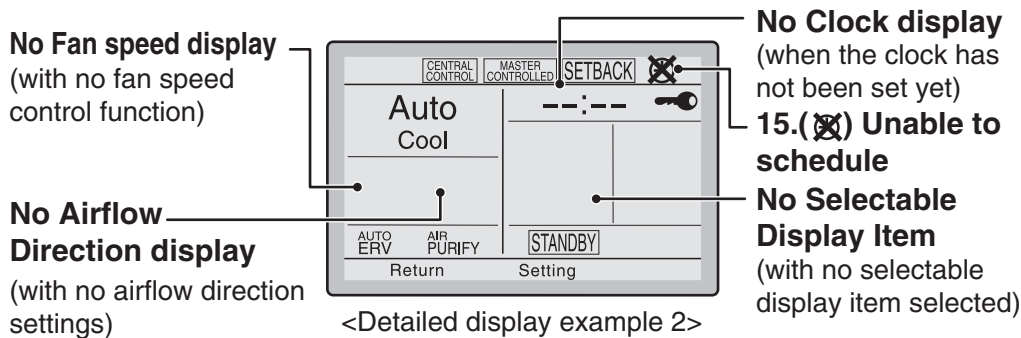
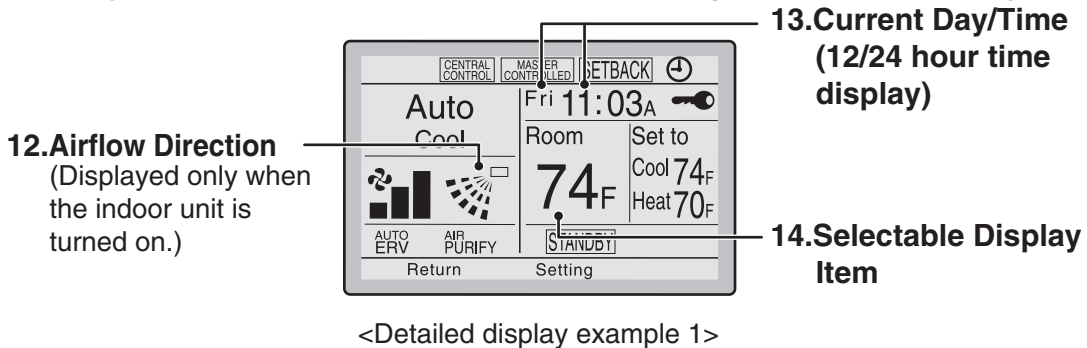

Simple display

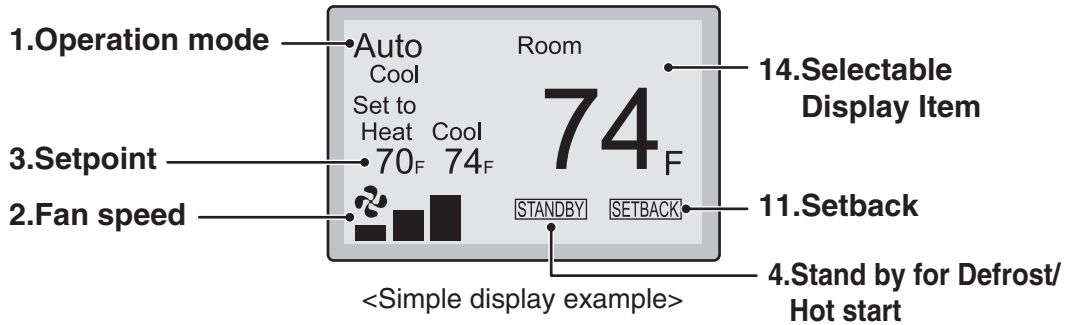

Note for all display modes

- Depending on the field settings, while the indoor unit is stopped, OFF may be displayed instead of the operation mode and/or the setpoint may not be displayed.

1. Operation mode

- Used to display the current operation mode: Cool, Heat, Vent, Fan, Dry or Auto.
- In Auto mode, the actual operation mode (Cool or Heat) will be also displayed.
- Operation mode cannot be changed when OFF is displayed.
Operation mode can be changed after starting operation.

2. Fan Speed

- Used to display the fan speed that is set for the indoor unit.
- The fan speed will not be displayed if the connected model does not have fan speed control functionality.

3. Setpoint

- Used to display the setpoint for the indoor unit.
- Use the Celsius/Fahrenheit item in the main menu to select the temperature unit (Celsius or Fahrenheit).

4. Stand by for Defrost/Hot start

“”

If ventilation icon is displayed in this field:

- Indicates that an energy recovery ventilator (ERV) is connected.
For details, refer to the Operation Manual of the ERV.

5. Message

The following messages may be displayed.

“**This function is not available**”

- Displayed for a few seconds when an Operation button is pressed and the indoor unit does not provide the corresponding function.
- In a remote control group, the message will not appear if at least one of the indoor units provides the corresponding function.

“**Error: Push Menu button**”

“**Warning: Push Menu button**”

- Displayed if an error or warning is detected.



“**Time to clean filter**”

“**Time to clean element**”

“**Time to clean filter & element**”

- Displayed as a reminder when it is time to clean the filter and/or element.

6. Ventilation

- Displayed when an energy recovery ventilator is connected.
- **Ventilation Mode icon.** “ AUTO ERV BYPASS”
These icons indicate the current ventilation mode (ERV only) (AUTO, ERV, BYPASS).
- **Air Purify ICON** “ AIR PURIFY”
This icon indicates that the air purifying unit (Optional) is in operation.

7. Key Lock

- Displayed when the key lock is set.

8. Scheduled

- Displayed if the Schedule or Off timer is enabled.

9. Under Centralized control “”

- Displayed if the system is under the management of a multi-zone controller (Optional) and the operation of the system through the remote controller is limited.

10. Changeover controlled by the master indoor unit “” (VRV only)

- Displayed when another indoor unit on the system has the authority to change the operation mode between cool and heat.

11. Setback “”

- The setback icon flashes when the unit is turned on by the setback control.

12. Airflow Direction “”

- Displayed when the airflow direction and swing are set.
- If the connected indoor unit model does not include oscillating louvers this item will not be displayed.

13. Current Day/Time (12/24 hour time display)

- Displayed if the clock is set.
- If the clock is not set, “-- : --” will be displayed.
- 12 hour time format is displayed by default.
- Select 12/24 hour time display option in the main menu under “Clock & Calendar”.

14. Selectable Display Item

- Room temperature is selected by default.
- For other choices see the operation manual.

15. ~~X~~Unable to schedule

- Displayed when the clock needs to be set.
- The schedule function will not work unless the clock is set.

Part 6

Service Diagnosis

1. General Problem Symptoms and Check Items	109
2. Troubleshooting with LED	110
2.1 Indoor Unit.....	110
2.2 Outdoor Unit.....	111
3. Service Diagnosis	112
3.1 ARC480 Series.....	112
3.2 ARC466 Series.....	115
3.3 BRC1E73	118
3.4 BRC082A43	120
4. Error Codes and Description.....	124
5. Troubleshooting for FTX, FVXS Series.....	125
5.1 Indoor Unit PCB Abnormality	125
5.2 Freeze-up Protection Control/Heating Peak-cut Control	127
5.3 Indoor Fan Motor (DC Motor) or Related Abnormality	129
5.4 Thermistor or Related Abnormality.....	133
5.5 Low-voltage Detection or Over-voltage Detection.....	134
5.6 Signal Transmission Error (Between Indoor Unit and Outdoor Unit).....	136
5.7 Unspecified Voltage (Between Indoor Unit and Outdoor Unit).....	138
6. Troubleshooting for FDMQ Series	139
6.1 Indoor Unit PCB Abnormality	139
6.2 Drain Level Control System Abnormality.....	140
6.3 Indoor Fan Motor (DC Motor) or Related Abnormality	141
6.4 Indoor Fan PCB Abnormality.....	143
6.5 Humidifier or Related Abnormality.....	144
6.6 Thermistor or Related Abnormality.....	145
6.7 Remote Controller Thermistor Abnormality	146
6.8 Low-voltage Detection or Over-voltage Detection.....	147
6.9 Signal Transmission Error (Between Indoor and Outdoor Unit)	149
6.10 Signal Transmission Error (Between Indoor Unit and Remote Controller).....	151
6.11 Signal Transmission Error (Between MAIN/SUB Remote Controllers)	152
6.12 Mismatching of Indoor Unit and Outdoor Unit	153
7. Troubleshooting for Outdoor Unit.....	154
7.1 Outdoor Unit PCB Abnormality.....	154
7.2 Actuation of High Pressure Switch	155
7.3 OL Activation (Compressor Overload) or HPS Activation (High Pressure Switch).....	157
7.4 OL Activation (Compressor Overload)	160
7.5 Compressor Lock	163

7.6	DC Fan Lock	164
7.7	Input Overcurrent Detection	165
7.8	Four Way Valve Abnormality	167
7.9	Discharge Pipe Temperature Control	169
7.10	High Pressure Control in Cooling	170
7.11	System Shutdown due to Temperature Abnormality in the Compressor	172
7.12	Compressor Sensor System Abnormality	173
7.13	Position Sensor Abnormality	174
7.14	Thermistor or Related Abnormality (Outdoor Unit)	177
7.15	Electrical Box Temperature Rise	179
7.16	Radiation Fin Temperature Rise	181
7.17	Output Overcurrent Detection	183
7.18	Signal Transmission Error on Outdoor Unit PCB	185
8.	Check	186
8.1	Thermistor Resistance Check	186
8.2	Indoor Fan Motor Connector Check	187
8.3	Power Supply Waveform Check	189
8.4	Electronic Expansion Valve Check	189
8.5	Four Way Valve Performance Check	190
8.6	Inverter Unit Refrigerant System Check	192
8.7	Inverter Analyzer Check	193
8.8	Outdoor Fan Motor Check	196
8.9	Installation Condition Check	197
8.10	Discharge Pressure Check	197
8.11	Outdoor Fan System Check	198
8.12	Main Circuit Short Check	198
8.13	Power Module Check	201

1. General Problem Symptoms and Check Items

Symptom	Check Item	Measures	Reference Page
The unit does not operate.	Check the power supply.	Check if the rated voltage is supplied.	—
	Check the type of the indoor unit.	Check if the indoor unit type is compatible with the outdoor unit.	—
	Check the outdoor temperature.	Heating/cooling operations are not available when the outdoor temperature is out of the operation limit. Check the reference page for the operation limit.	249
	Diagnose with remote controller indication.	—	124
	Check the remote controller addresses.	Check if address settings for the remote controller and indoor unit are correct.	214
Operation sometimes stops.	Check the power supply.	A power failure of 2 to 10 cycles stops air conditioner operation. (Operation lamp OFF)	—
	Check the outdoor temperature.	Heating/cooling operations are not available when the outdoor temperature is out of the operation limit. Check the reference page for the operation limit.	249
	Diagnose with remote controller indication.	—	124
The unit operates but does not cool, or does not heat.	Check for wiring and piping errors in the connection between the indoor unit and outdoor unit.	—	—
	Check for thermistor detection errors.	Check if the thermistor is mounted securely.	—
	Check for faulty operation of the electronic expansion valve.	Set the unit to cooling operation, and check the temperature of the liquid pipe to see if the electronic expansion valve works.	—
	Diagnose with remote controller indication.	—	124
	Diagnose by service port pressure and operating current.	Check for refrigerant shortage.	—
Large operating noise and vibrations	Check the resistance between the terminals of the power module.	—	201
	Check the power module.	—	—
	Check the installation condition.	Check if the required spaces for installation (specified in the installation manual) are provided.	—

2. Troubleshooting with LED

2.1 Indoor Unit

Operation Lamp

■ FTX, FVXS

Check the interval time between blinks of the OPERATION lamp.

Blink every 0.5 seconds

This is a notification of an abnormality.

Conduct the diagnostic procedure described in the following pages.

● FTX Series

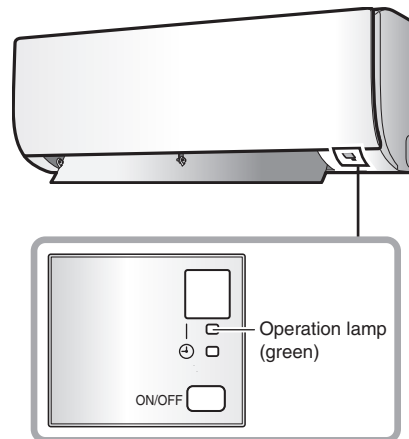

R6000666

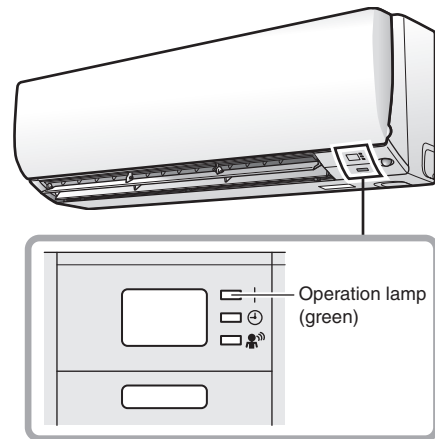

R6000667

● FVXS Series

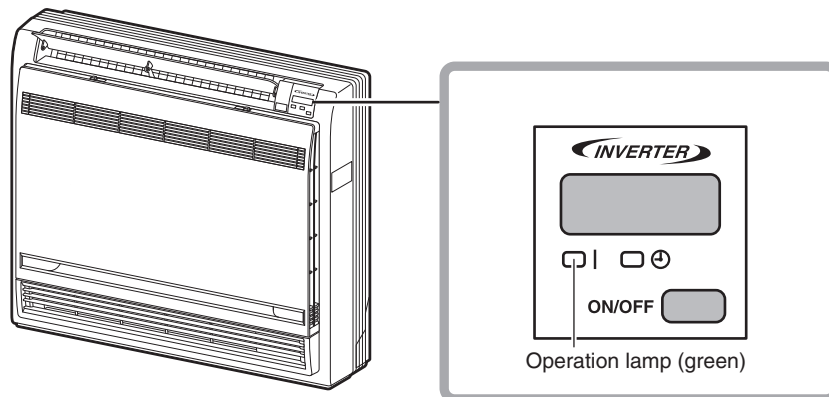

R4003515

■ FDMQ series with BRC1E73

If an error occurs, either one of the following messages will flash in the screen.

Error: Push Menu button

* The Operation lamp will blink.

* For Simple display, the message is not displayed, and only the Operation lamp blinks.

Warning: Push Menu button

* The Operation lamp will not blink.

* For Simple display, the message is not displayed, and the Operation lamp does not blink, either.

- Press Menu/OK button.

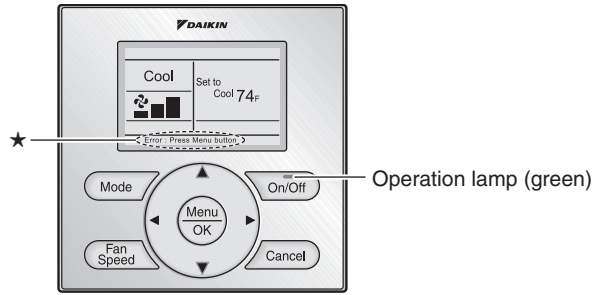

★The error or warning message also blinks on the basic screen.

R4003516

■ **FDMQ series with BRC082A43**

For wireless remote controller, a receiver is installed. When the error occurs, the operation lamp on the receiver blinks.

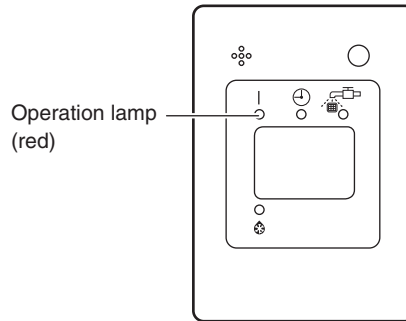

R4003517

2.2 Outdoor Unit

The outdoor unit has one green LED (LED A) on the PCB. When the microcomputer works in order, the LED A blinks. However, the LED A turns OFF while the standby electricity saving function is activated and the power supply is OFF.

Refer to page 33, 35, 37, 38 for the location of LED A.

3. Service Diagnosis

3.1 ARC480 Series

3.1.1 Method 1

1. When **TIMER CANCEL** button is held down for 5 seconds, **00** is displayed on the temperature display screen.
2. Press **TIMER CANCEL** button repeatedly until a long beep sounds.



R6000690



Note(s)

1. A short beep or two consecutive beeps indicate non-corresponding codes.
2. To return to the normal mode, hold **TIMER CANCEL** button down for 5 seconds. When the remote controller is left untouched for 60 seconds, it also returns to the normal mode.
3. Not all the error codes are displayed. When you cannot find the error code, try method 2. Refer to page 113.

- The code indication changes in the sequence shown below.

ARC480A8

No.	Code	No.	Code	No.	Code	No.	Code
1	00	12	H0	23	J3	34	H7
2	A5	13	A6	24	J6	35	U2
3	E7	14	U0	25	J8	36	EA
4	F3	15	C7	26	E5	37	AH
5	F6	16	A3	27	A1	38	FA
6	L3	17	H8	28	E1	39	E8
7	L4	18	H9	29	UA	40	CH
8	L5	19	C9	30	U3	41	J9
9	U4	20	CC	31	UF	42	E3
10	E6	21	C4	32	UH	43	H3
11	H6	22	C5	33	P4		

3.1.2 Method 2

1. Press the center of **TEMP** button and **OFF** button at the same time.

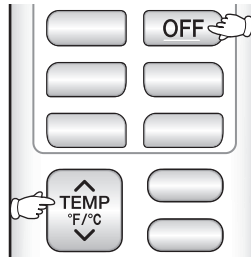

SC is displayed on the LCD.

R6000668

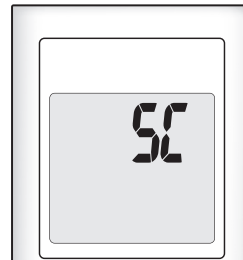

R6000695

2. Select **SC** (service check) with **TEMP** \wedge or **TEMP** \vee button.
3. Press **FAN** button to enter the service check mode.

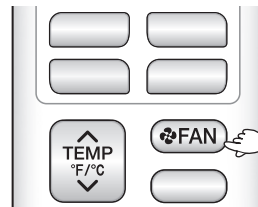

00 is displayed and the left-side number blinks.

R6000669

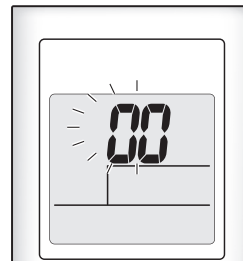

R6000696

4. Press **TEMP** \wedge or **TEMP** \vee button and change the number until you hear the two consecutive beeps or the long beep.

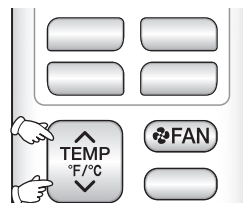

R6000670

5. Diagnose by the sound.
 - Beep: The left-side number does not correspond with the error code.
 - Two consecutive beeps: The left-side number corresponds with the error code but the right-side number does not.

- Long beep: Both the left-side and right-side numbers correspond with the error code.
The numbers indicated when you hear the long beep are the error code.
Refer to page 124.

6. Press **FAN** button.

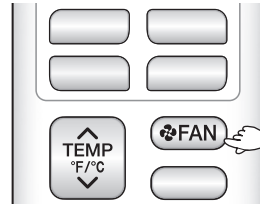

The right-side number blinks.

R6000669

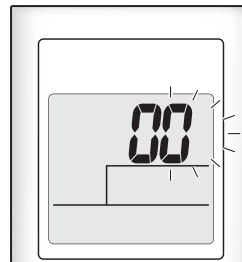

7. Press **TEMP** ^ or **TEMP** v button and change the number until you hear the long beep.

R6000697

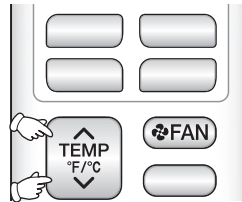

R6000670

8. Diagnose by the sound.

- Beep: The left-side number does not correspond with the error code.
- Two consecutive beeps: The left-side number corresponds with the error code but the right-side number does not.
- Long beep: Both the left-side and right-side numbers correspond with the error code.

9. Determine the error code.

The numbers indicated when you hear the long beep are the error code.
Refer to page 124.

10. Press **FAN** button for 5 seconds to exit from the service check mode.

When the remote controller is left untouched for 60 seconds, it returns to the normal mode also.

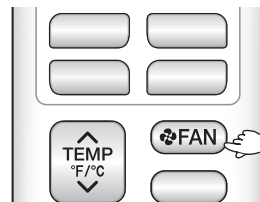

R6000669

3.2 ARC466 Series

3.2.1 Method 1

1. When **Timer Cancel** button is held down for 5 seconds, **00** is displayed on the temperature display screen.
2. Press **Timer Cancel** button repeatedly until a long beep sounds.

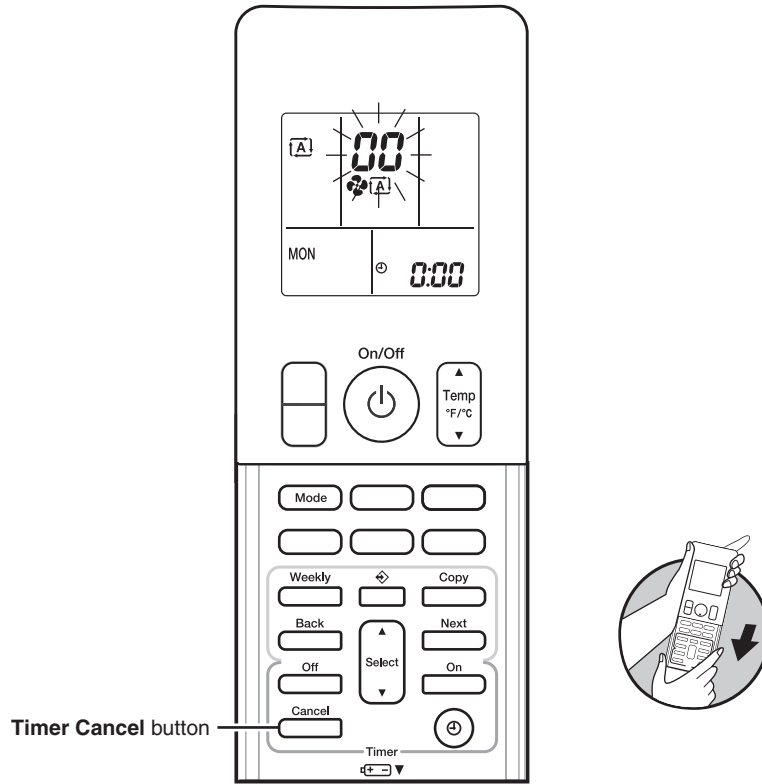

< ARC466 Series >

(R24045)

i Note(s)

1. A short beep or two consecutive beeps indicate non-corresponding codes.
2. To return to the normal mode, hold **Timer Cancel** button down for 5 seconds. When the remote controller is left untouched for 60 seconds, it also returns to the normal mode.
3. Not all the error codes are displayed. When you cannot find the error code, try method 2. Refer to page 116.

■ The code indication changes in the sequence shown below.

ARC466A21, A37

No.	Code	No.	Code	No.	Code	No.	Code
1	00	11	H6	21	C5	31	U2
2	A5	12	H0	22	J3	32	EA
3	E7	13	A6	23	J6	33	AH
4	F3	14	U0	24	E5	34	FA
5	F6	15	C7	25	A1	35	H1
6	L3	16	A3	26	E1	36	P9
7	L4	17	H8	27	UA	37	E3
8	L5	18	H9	28	UH	38	H3
9	U4	19	C9	29	P4		
10	E6	20	C4	30	H7		

3.2.2 Method 2

1. Press the center of **Temp** button and **Mode** button at the same time.

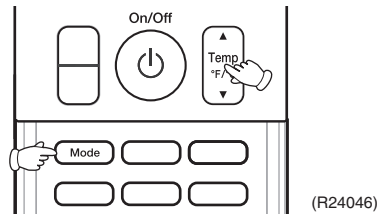

SC is displayed on the LCD.

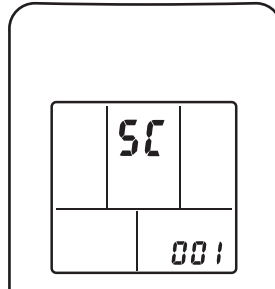

2. Select **SC** (service check) with **Temp ▲** or **Temp ▼** button.
3. Press **Mode** button to enter the service check mode.

R6000375

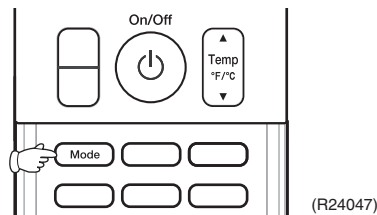

The left-side number blinks.

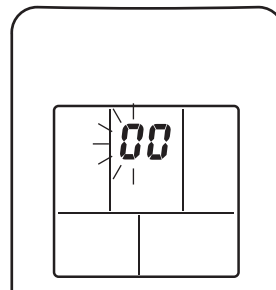

4. Press **Temp ▲** or **Temp ▼** button and change the number until you hear the two consecutive beeps or the long beep.

R6000373

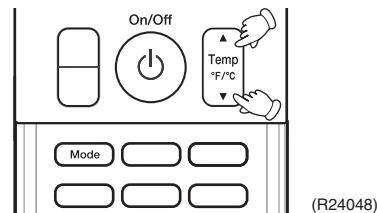

5. Diagnose by the sound.
 - Beep: The left-side number does not correspond with the error code.
 - Two consecutive beeps: The left-side number corresponds with the error code but the right-side number does not.

- Long beep: Both the left-side and right-side numbers correspond with the error code. The numbers indicated when you hear the long beep are the error code. Refer to page 124.

6. Press **Mode** button.

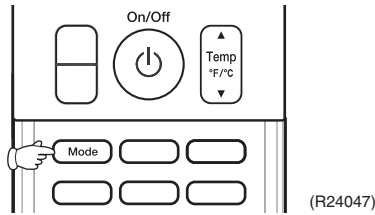

The right-side number blinks.

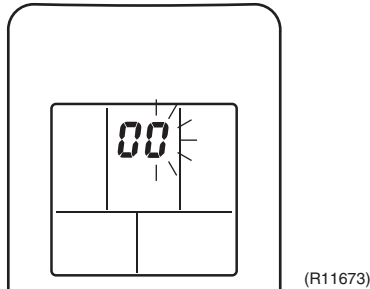

7. Press **Temp ▲** or **Temp ▼** button and change the number until you hear the long beep.

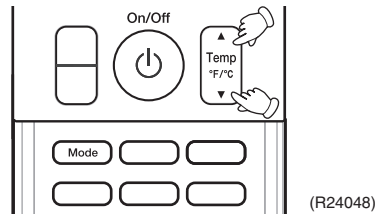

8. Diagnose by the sound.

- Beep: The left-side number does not correspond with the error code.
- Two consecutive beeps: The left-side number corresponds with the error code but the right-side number does not.
- Long beep: Both the left-side and right-side numbers correspond with the error code.

9. Determine the error code.

The numbers indicated when you hear the long beep are the error code. Refer to page 124.

10. Press **Mode** button for 5 seconds to exit from the service check mode.

When the remote controller is left untouched for 60 seconds, it returns to the normal mode also.

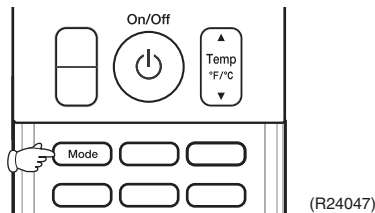

3.3 BRC1E73

Relations Between Modes

On power-up, the message “**Checking the connection. Please standby.**” will be displayed on the remote controller screen temporarily and then the basic screen will be displayed. To access a mode from the basic screen, refer to the figure below.

When any of the operation buttons is pressed, the backlight will come on and remain lit for about 30 seconds. Be sure to press a button while the backlight is on.

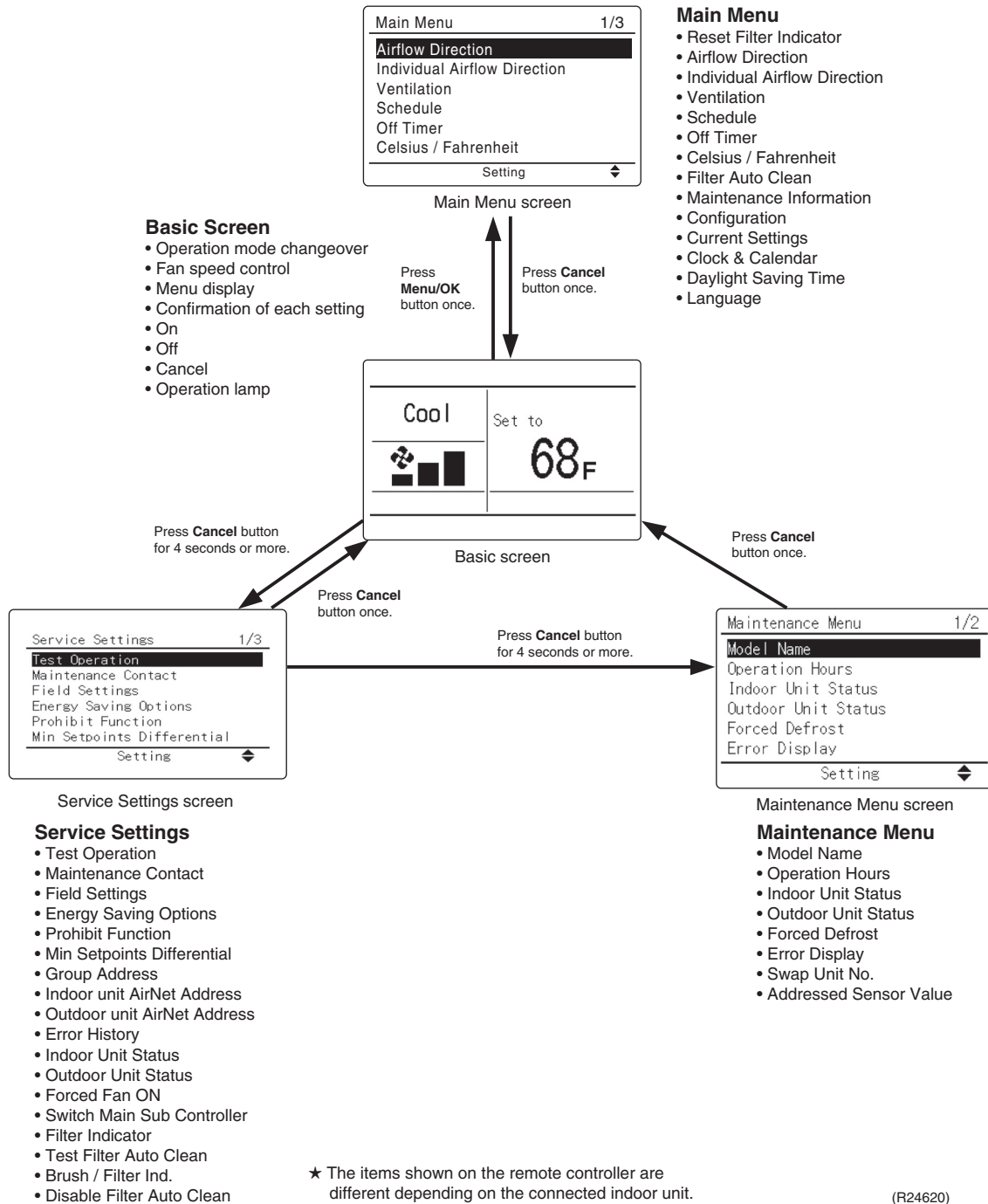

Service Diagnosis

The following message is displayed on the screen when an error (or a warning) occurs during operation.
Check the error code and take the corrective action specified for the particular model.

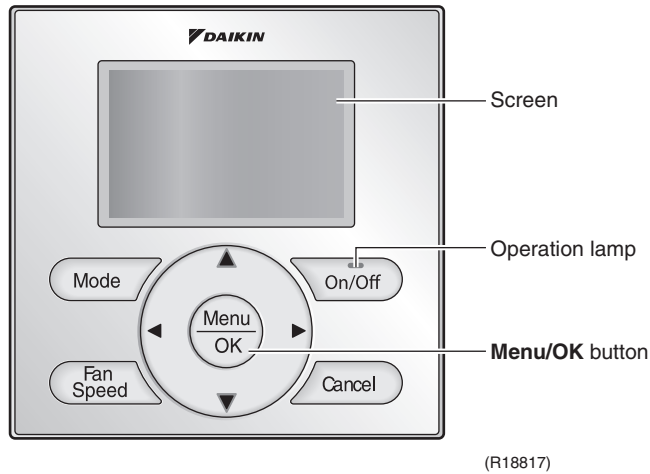

(R18817)

Operation

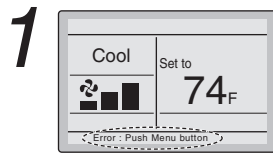

- If an error occurs, either one of the following items will flash in the basic screen.

Error: Push Menu button

- * The Operation lamp will flash.
- * For Simple display, the message is not displayed, and only the Operation lamp flashes.

Warning: Push Menu button

- * The Operation lamp will not flash.
- * For Simple display, the message is not displayed, and the Operation lamp does not flash, either.

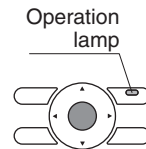

- Press **Menu/OK** button.

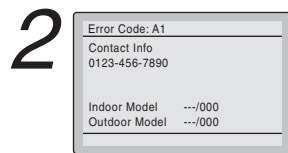

- The error code will flash and the service contact and model name or code may be displayed.
- Notify your Daikin dealer of the Error code and model name or code.

3.4 BRC082A43

Relations Between Modes

The following modes can be selected by using **INSPECTION/TEST OPERATION** button on the remote controller.

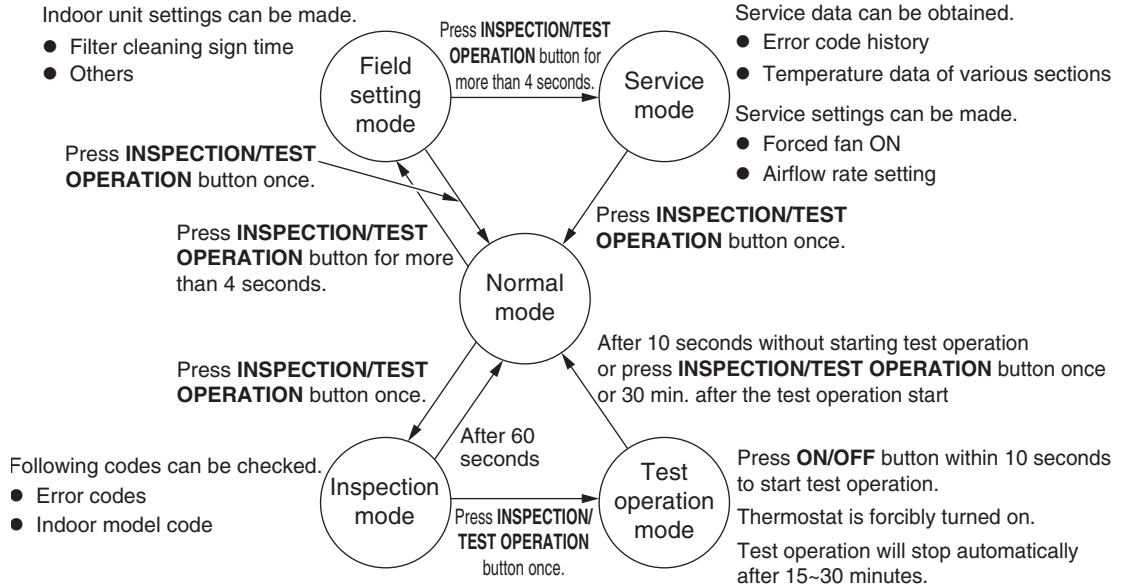

(R24049)

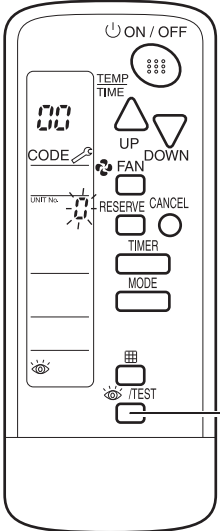

Service Diagnosis

To find the error code, proceed as follows:

Step	Action
1	<p>Press INSPECTION/TEST OPERATION button to enter the inspection mode. Then the figure  blinks on the UNIT No. display.</p>  <p>INSPECTION/TEST OPERATION button</p>

(R24050)

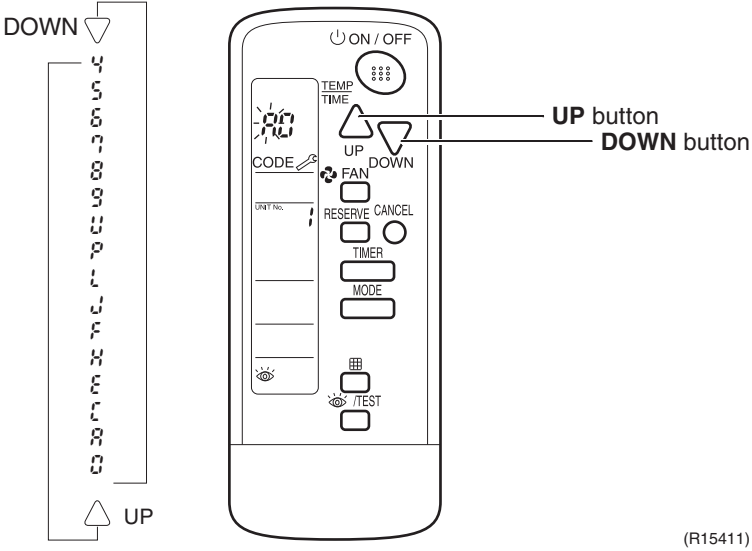
Step	Action								
<p>2</p>	<p>Press UP or DOWN button and change the UNIT No. until the indoor unit starts to beep.</p> <div data-bbox="751 310 1279 846" style="text-align: center;"> </div> <p style="text-align: right;">(R15408)</p> <table border="1" style="width: 100%; margin-top: 20px;"> <thead> <tr> <th data-bbox="643 923 1019 959">If you hear...</th> <th data-bbox="1019 923 1398 959">Then...</th> </tr> </thead> <tbody> <tr> <td data-bbox="643 959 1019 995">3 short beeps</td> <td data-bbox="1019 959 1398 995">Follow all steps below.</td> </tr> <tr> <td data-bbox="643 995 1019 1129">1 short beep</td> <td data-bbox="1019 995 1398 1129">Follow steps 3 and 4. Continue the operation in step 4 until you hear a long beep. This long beep indicates that the error code is confirmed.</td> </tr> <tr> <td data-bbox="643 1129 1019 1166">1 long beep</td> <td data-bbox="1019 1129 1398 1166">There is no abnormality.</td> </tr> </tbody> </table>	If you hear...	Then...	3 short beeps	Follow all steps below.	1 short beep	Follow steps 3 and 4. Continue the operation in step 4 until you hear a long beep. This long beep indicates that the error code is confirmed.	1 long beep	There is no abnormality.
If you hear...	Then...								
3 short beeps	Follow all steps below.								
1 short beep	Follow steps 3 and 4. Continue the operation in step 4 until you hear a long beep. This long beep indicates that the error code is confirmed.								
1 long beep	There is no abnormality.								
<p>3</p>	<p>Press OPERATION MODE SELECTOR button. The left (upper digit) indication of the error code blinks.</p> <div data-bbox="743 1268 1295 1804" style="text-align: center;"> </div> <p style="text-align: right;">(R24051)</p>								

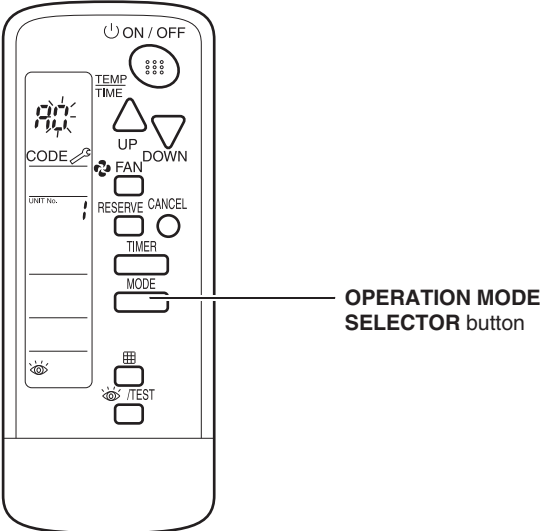
Step	Action								
<p>4</p>	<p>Press UP or DOWN button to change the error code upper digit until the indoor unit beeps.</p>  <p>(R15411)</p> <table border="1" data-bbox="641 932 1398 1076"> <thead> <tr> <th>If you hear...</th> <th>Then...</th> </tr> </thead> <tbody> <tr> <td>2 short beeps</td> <td>The upper digit matches.</td> </tr> <tr> <td>1 short beep</td> <td>No digits match.</td> </tr> <tr> <td>1 long beep</td> <td>Both upper and lower digits match.</td> </tr> </tbody> </table>	If you hear...	Then...	2 short beeps	The upper digit matches.	1 short beep	No digits match.	1 long beep	Both upper and lower digits match.
If you hear...	Then...								
2 short beeps	The upper digit matches.								
1 short beep	No digits match.								
1 long beep	Both upper and lower digits match.								
<p>5</p>	<p>Press OPERATION MODE SELECTOR button. The right  (lower digit) indication of the error code blinks.</p>  <p>(R24052)</p>								

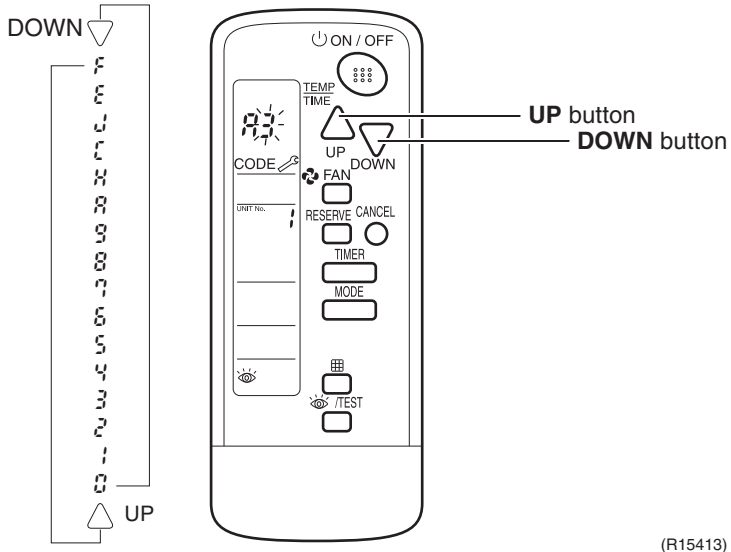
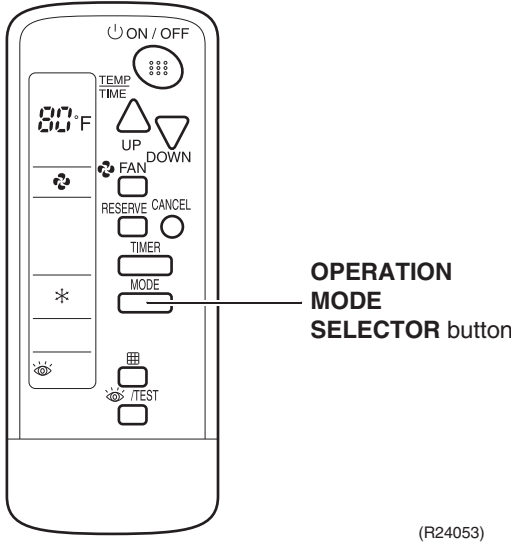
Step	Action						
<p>6</p>	<p>Press UP or DOWN button and change the error code lower digit until the indoor unit generates long beep.</p>  <p style="text-align: right;">(R15413)</p> <table border="1" data-bbox="641 932 1398 1042"> <thead> <tr> <th>If you hear...</th> <th>Then...</th> </tr> </thead> <tbody> <tr> <td>2 short beeps</td> <td>No digits match.</td> </tr> <tr> <td>1 long beep</td> <td>Both upper and lower digits match.</td> </tr> </tbody> </table>	If you hear...	Then...	2 short beeps	No digits match.	1 long beep	Both upper and lower digits match.
If you hear...	Then...						
2 short beeps	No digits match.						
1 long beep	Both upper and lower digits match.						
<p>7</p>	<p>Press OPERATION MODE SELECTOR button to return to the normal mode. If you do not press any button for 1 minute, the remote controller automatically returns to the normal mode.</p>  <p style="text-align: right;">(R24053)</p>						

4. Error Codes and Description

	Error Codes	Description	Reference Page		
			FTX	FVXS	FDMQ
System	00	Normal	—	—	—
	U0★	Refrigerant shortage	—	—	—
	U2	Low-voltage detection or over-voltage detection	134	134	147
	U4	Signal transmission error (between indoor unit and outdoor unit)	136	136	149
	U5	Signal transmission error (between indoor unit and remote controller)	—	—	151
	U8	Signal transmission error (between MAIN/SUB remote controller)	—	—	152
	UA	Unspecified voltage (between indoor unit and outdoor unit)	138	138	153
Indoor Unit	A1	Indoor unit PCB abnormality	125	125	139
	A3	Drain level control system abnormality	—	—	140
	A5	Freeze-up protection control/heating peak-cut control	127	127	—
	A6	Indoor fan motor (DC motor) or related abnormality	129	129	141
	A8	Indoor fan PCB abnormality	—	—	143
	AF	Humidifier or related abnormality	—	—	144
	C4	Indoor heat exchanger thermistor or related abnormality	133	133	145
	C5		—	—	145
	C9	Room temperature thermistor or related abnormality	133	133	145
CJ	Remote controller thermistor abnormality	—	—	146	
Outdoor Unit	E1	Outdoor unit PCB abnormality	154		
	E3★	Actuation of high pressure switch	155		
	E5★	OL activation (compressor overload) or HPS activation (high pressure switch)	157		
			OL activation (compressor overload)		
	E6★	Compressor lock	163		
	E7★	DC fan lock	164		
	E8	Input overcurrent detection	165		
	EA★	Four way valve abnormality	167		
	F3★	Discharge pipe temperature control	169		
	F6	High pressure control in cooling	170		
	F8	System shutdown due to temperature abnormality in the compressor	172		
	H0★	Compressor system sensor abnormality	173		
	H6★	Position sensor abnormality	174		
	H9	Outdoor temperature thermistor or related abnormality	177		
	J3★	Discharge pipe thermistor or related abnormality	177		
	J6	Outdoor heat exchanger thermistor or related abnormality	177		
	L3	Electrical box temperature rise	179		
	L4	Radiation fin temperature rise	181		
L5★	Output overcurrent detection	183			
P4	Radiation fin thermistor or related abnormality	177			
U7	Signal transmission error on outdoor unit PCB	185			

★: Displayed only when system down occurs for method 1.

5. Troubleshooting for FTX, FVXS Series

5.1 Indoor Unit PCB Abnormality

Error Code	A1
Method of Error Detection	The system checks if the circuit works properly within the microcomputer of the indoor unit.
Error Decision Conditions	The system cannot set the internal settings.
Supposed Causes	<ul style="list-style-type: none"> ■ Wrong models interconnected ■ Defective indoor unit PCB ■ Disconnection of connector ■ Reduction of power supply voltage

Troubleshooting

 **Caution** Be sure to turn off the power switch before connecting or disconnecting connectors, or parts may be damaged.

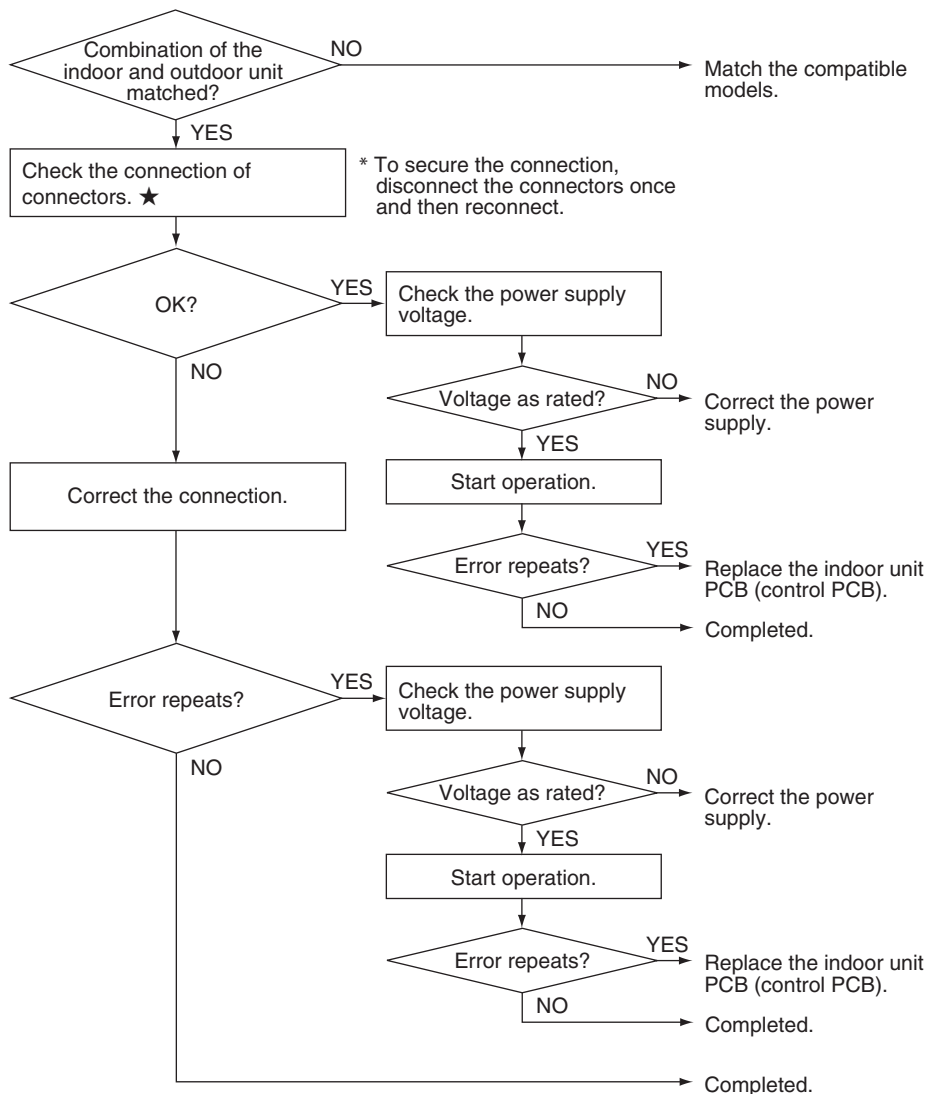

(R23407)

**Note****★Connectors**

FTX09/12/18/24 FVXS	Terminal ~ Control PCB (H1, H2, H3)
FTX15	Terminal ~ Filter PCB (S100) Filter PCB (S800) ~ Control PCB (S900)

5.2 Freeze-up Protection Control/Heating Peak-cut Control

Error Code	A5
Method of Error Detection	<ul style="list-style-type: none"> ■ Freeze-up protection control During cooling operation, the freeze-up protection control (operation halt) is activated according to the temperature detected by the indoor heat exchanger thermistor. ■ Heating peak-cut control During heating operation, the temperature detected by the indoor heat exchanger thermistor is used for the heating peak-cut control (operation halt, outdoor fan stop, etc.)
Error Decision Conditions	<ul style="list-style-type: none"> ■ Freeze-up protection control During cooling operation, the indoor heat exchanger temperature is below 0°C (32°F). ■ Heating peak-cut control During heating operation, the indoor heat exchanger temperature is above 59 ~ 60°C (138.2 ~ 140°F).
Supposed Causes	<ul style="list-style-type: none"> ■ Short-circuited air ■ Clogged air filter of the indoor unit ■ Dust accumulation on the indoor heat exchanger ■ Defective indoor heat exchanger thermistor ■ Defective indoor unit PCB

Troubleshooting

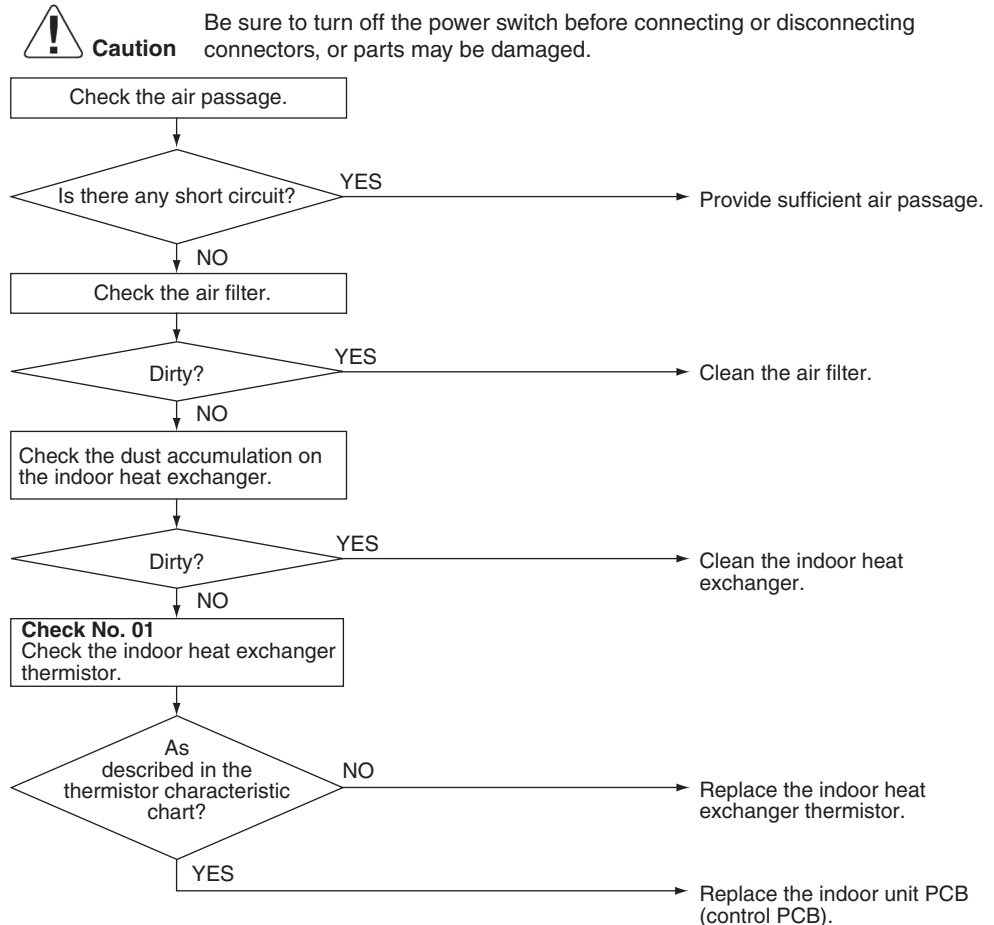

(R21064)



Reference

Check No.01 Refer to P.186

5.3 Indoor Fan Motor (DC Motor) or Related Abnormality

Error Code	A6
Method of Error Detection	The rotation speed detected by the Hall IC during indoor fan motor operation determines abnormal fan motor operation.
Error Decision Conditions	The detected rotation speed does not reach the demanded rotation speed of the target tap, and is less than 50% of the maximum fan motor rotation speed.
Supposed Causes	<ul style="list-style-type: none"> ■ Remarkable decrease in power supply voltage ■ Layer short inside the fan motor winding ■ Breaking of wire inside the fan motor ■ Breaking of the fan motor lead wires ■ Defective capacitor of the fan motor ■ Defective indoor unit PCB
Troubleshooting	FTX09/12/15



Caution

Be sure to turn off the power switch before connecting or disconnecting connectors, or parts may be damaged.

Turn off the power supply.
(Unplug the power cable or turn the breaker off.)

Note: The motor may break when the motor connector is disconnected with the power supply on.
(Turn off the power supply before connecting the connector also.)

Check the connector for connection.

* To secure the connection, once disconnect the connector and then reconnect it.

OK?

NO → Correct the connection.

YES

Foreign matters in or around the fan?

YES → Remove the foreign matters.

NO

Rotate the fan by hand.

(A) Go to the next page

(R23939)

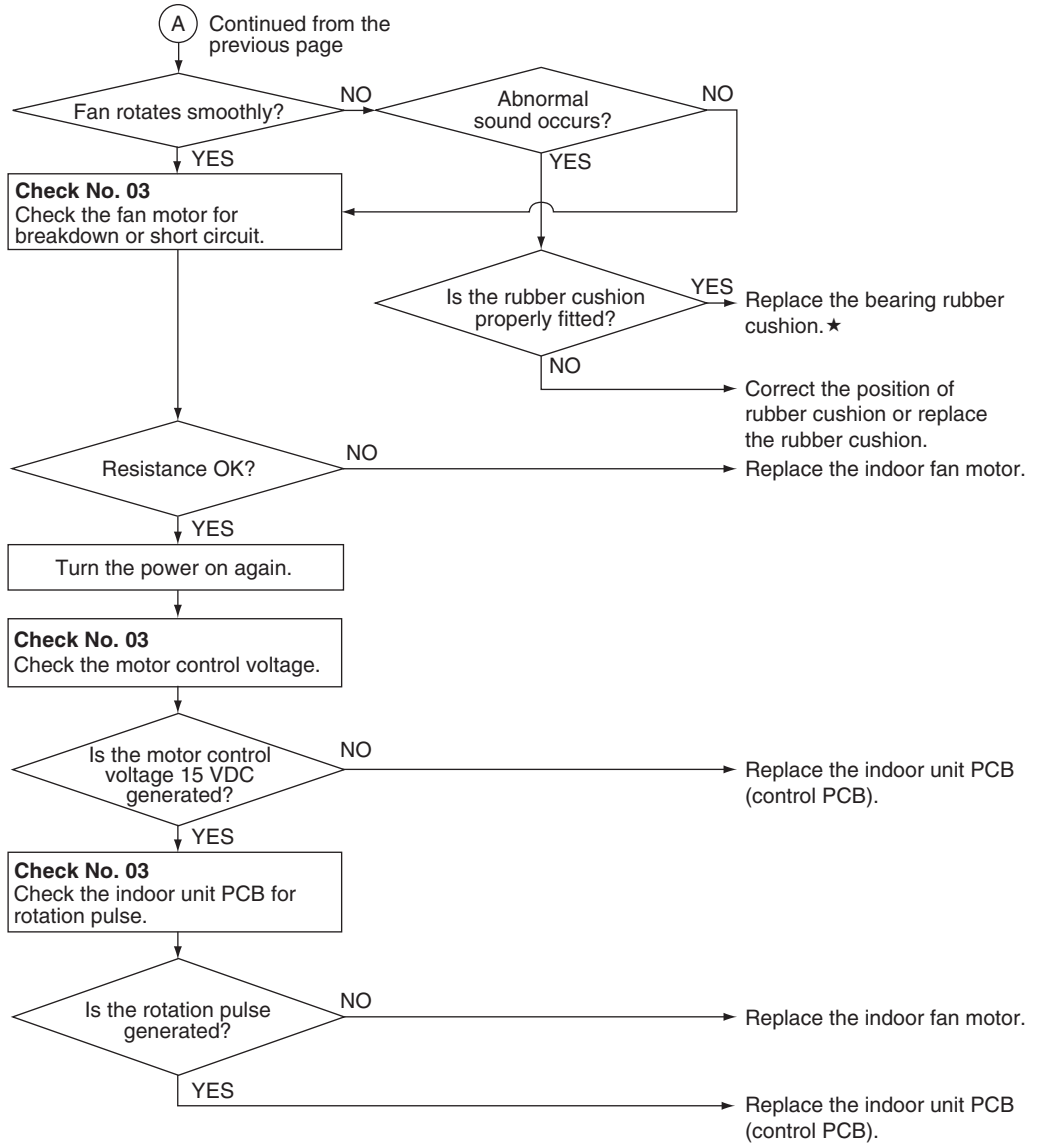

(R24945)

★Rubber cushion

09/12 class

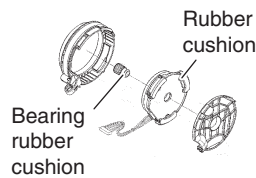

15 class

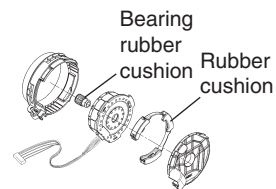

R6000673

R6000674

i Note(s)

The rotation pulse is the feedback signal from the indoor fan motor.

📄 Reference

Check No.03 Refer to P.187

Troubleshooting FTX18/24, FVXS



Caution

Be sure to turn off the power switch before connecting or disconnecting connectors, or parts may be damaged.

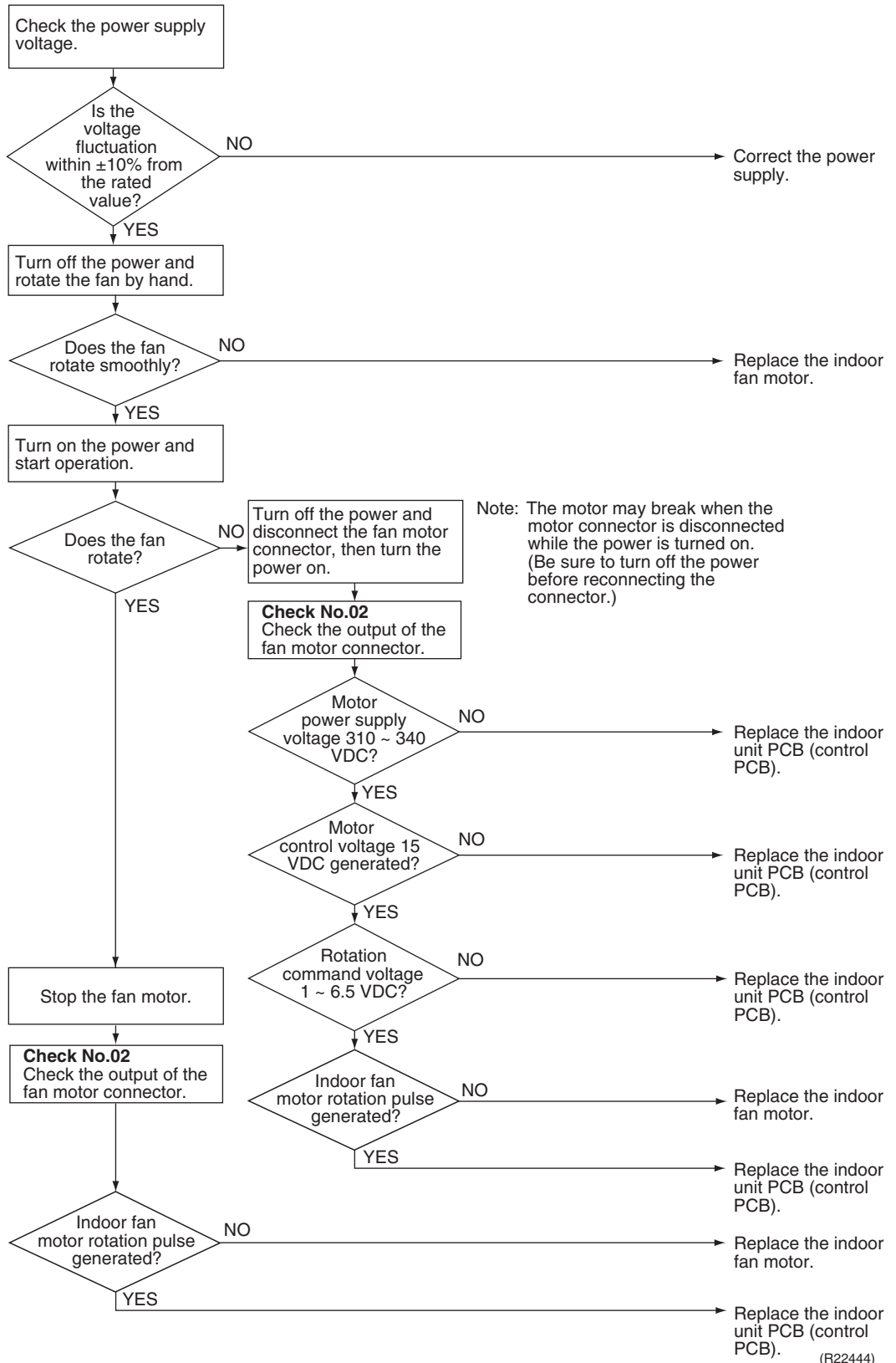



Note(s) The rotation pulse is the feedback signal from the indoor fan motor.



Reference **Check No.02** Refer to P.187

5.4 Thermistor or Related Abnormality

Error Code	C4, C9
Method of Error Detection	The temperatures detected by the thermistors determine thermistor errors.
Error Decision Conditions	The voltage between the both ends of the thermistor is either 4.96 V or more, or 0.04 V or less with the power on.
Supposed Causes	<ul style="list-style-type: none"> ■ Disconnection of connector ■ Defective thermistor(s) ■ Defective indoor unit PCB

Troubleshooting

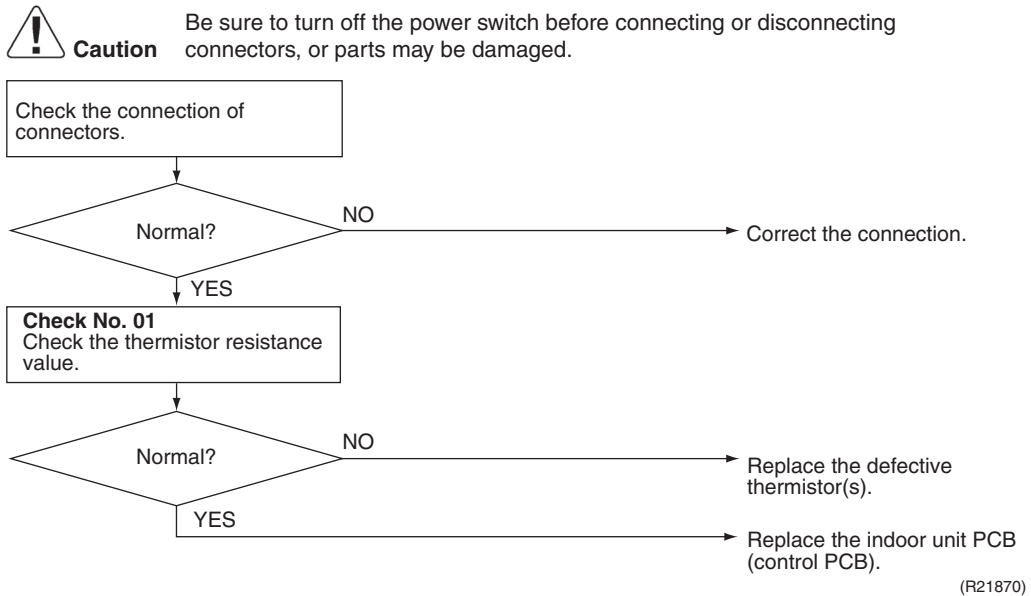

C4 : Indoor heat exchanger thermistor
C9 : Room temperature thermistor



Reference

Check No.01 Refer to P.186

5.5 Low-voltage Detection or Over-voltage Detection

Error Code	U2
Method of Error Detection	<p>Low-voltage detection: An abnormal voltage drop is detected by the DC voltage detection circuit.</p> <p>Over-voltage detection: An abnormal voltage rise is detected by the over-voltage detection circuit.</p>
Error Decision Conditions	<p>Low-voltage detection:</p> <ul style="list-style-type: none"> ■ The voltage detected by the DC voltage detection circuit is below 150 ~ 200 V (depending on the model). ■ The compressor stops if the error occurs, and restarts automatically after 3-minute standby. <p>Over-voltage detection:</p> <ul style="list-style-type: none"> ■ An over-voltage signal is fed from the over-voltage detection circuit to the microcomputer (over 458 ~ 500 V, depending on the model). ■ The compressor stops if the error occurs, and restarts automatically after 3-minute standby.
Supposed Causes	<ul style="list-style-type: none"> ■ Power supply voltage out of specification ■ Defective DC voltage detection circuit ■ Defective over-voltage detection circuit ■ Defective PAM control part ■ Disconnection of compressor harness ■ Short circuit inside the fan motor winding ■ Noise ■ Momentary drop of voltage ■ Momentary power failure ■ Defective outdoor unit PCB

Troubleshooting

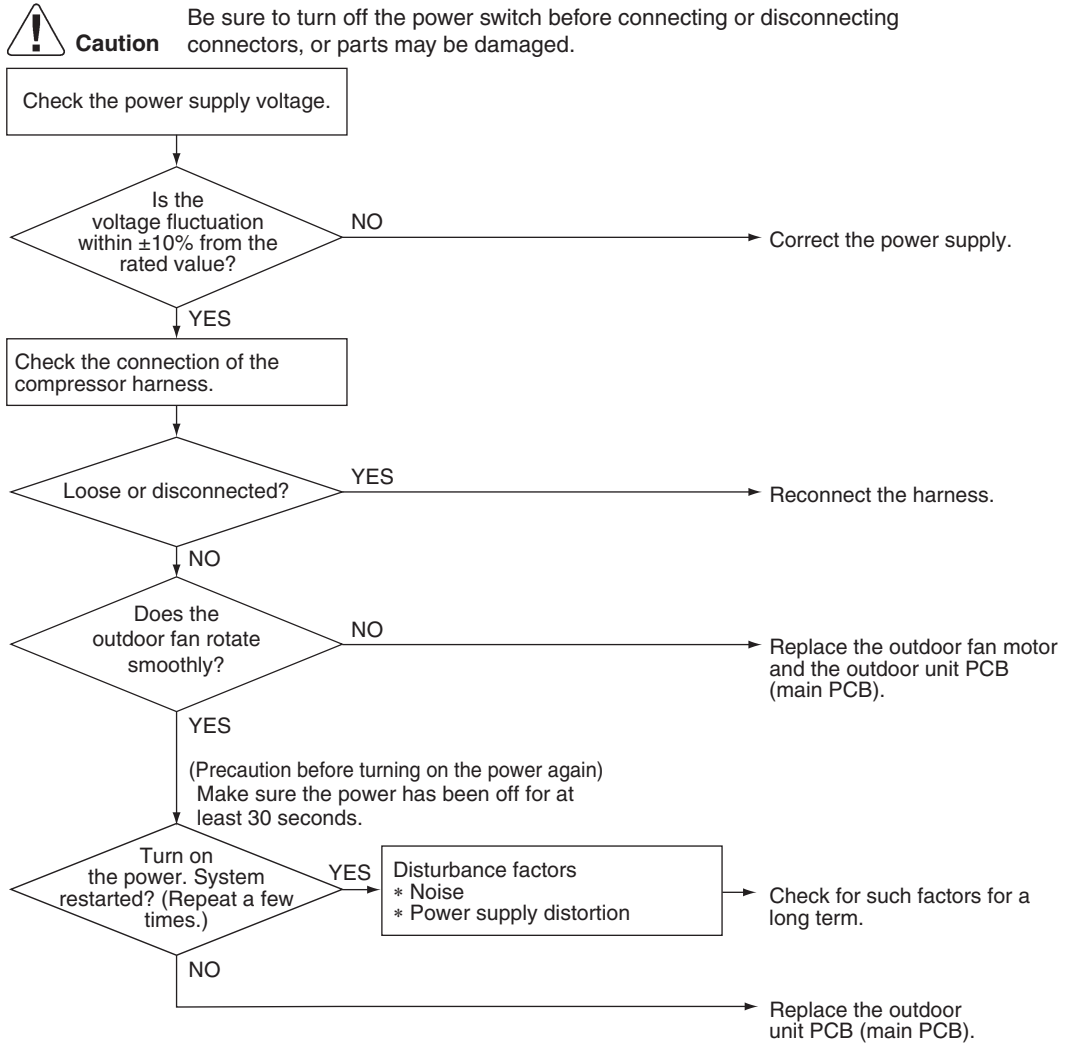

(R22445)

5.6 Signal Transmission Error (Between Indoor Unit and Outdoor Unit)

Error Code	U4
Method of Error Detection	The signal transmission data received from the outdoor unit is checked whether it is normal.
Error Decision Conditions	The data sent from the outdoor unit cannot be received normally, or the content of the data is abnormal.
Supposed Causes	<ul style="list-style-type: none">■ Power supply voltage not as specified■ Reduction of power supply voltage■ Wiring error■ Breaking of the connection wires between the indoor and outdoor units (wire No. 3)■ Defective outdoor unit PCB■ Short circuit inside the fan motor winding■ Defective indoor unit PCB■ Disturbed power supply waveform

Troubleshooting

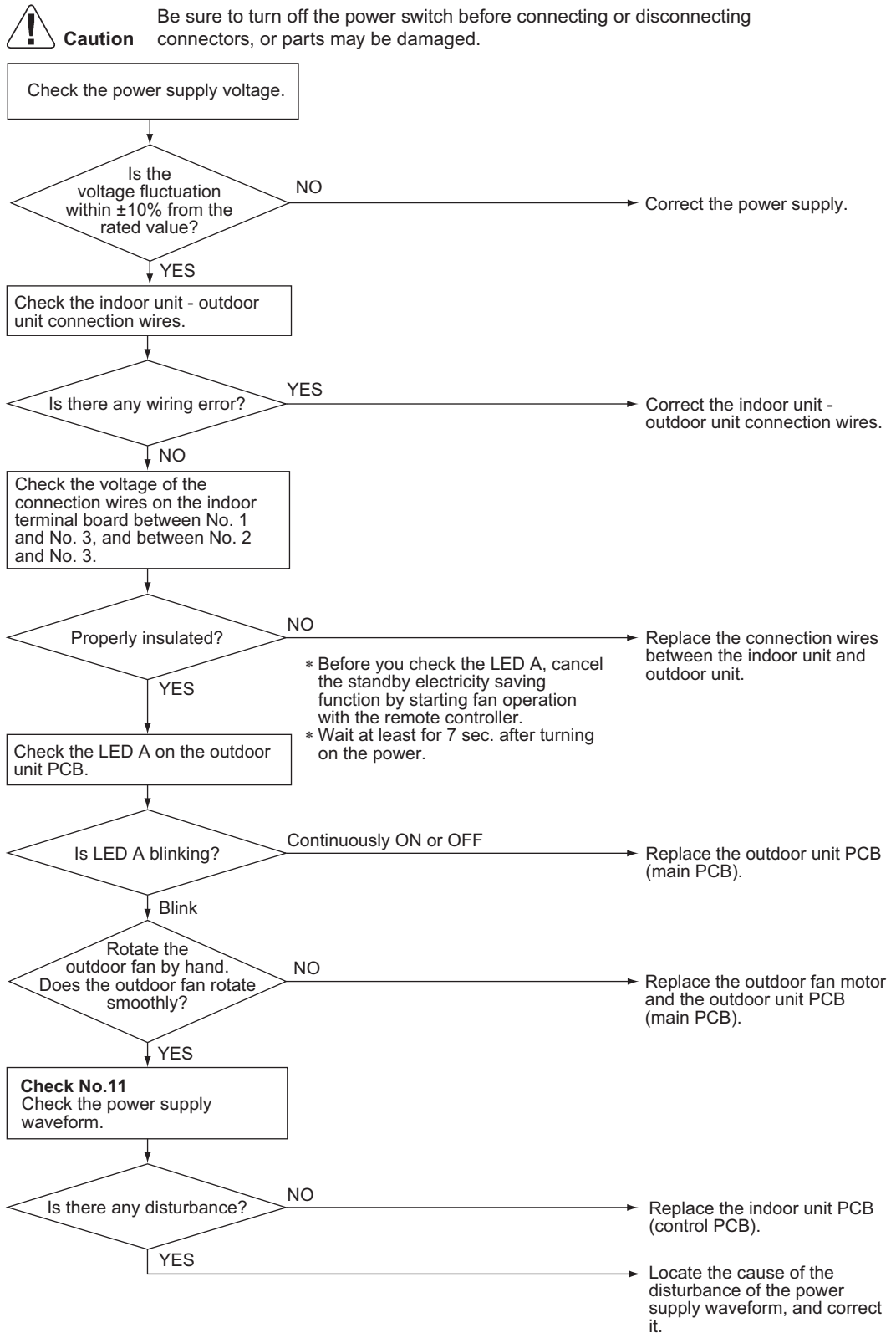

(R21189)



Reference Check No.11 Refer to P.189

5.7 Unspecified Voltage (Between Indoor Unit and Outdoor Unit)

Error Code

UA

Method of Error Detection

The supply power is detected for its requirements (pair type is different from multi type) by the indoor/outdoor transmission signal.

Error Decision Conditions

The pair type and multi type are interconnected.

Supposed Causes

- Wrong models interconnected
- Wrong wiring of connecting wires
- Wrong indoor unit PCB or outdoor unit PCB mounted
- Defective indoor unit PCB
- Defective outdoor unit PCB

Troubleshooting



Caution

Be sure to turn off the power switch before connecting or disconnecting connectors, or parts may be damaged.

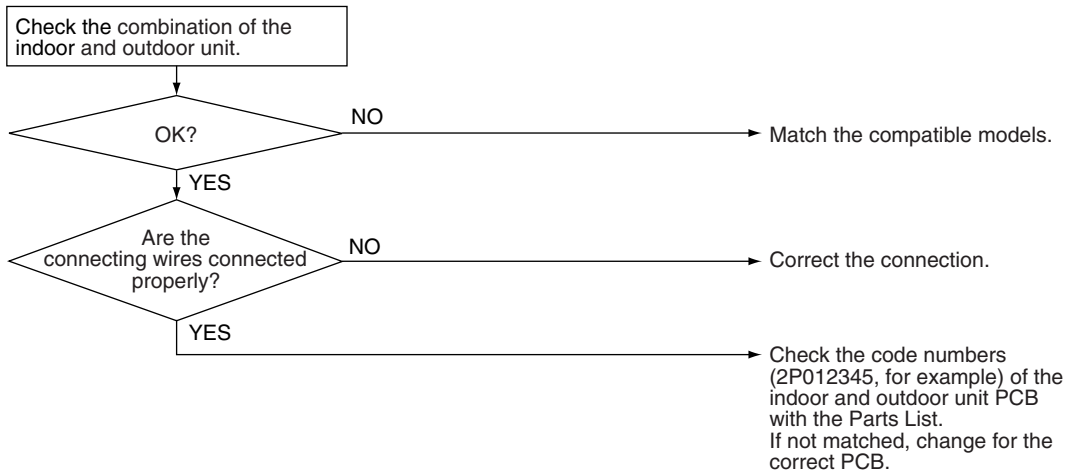

6. Troubleshooting for FDMQ Series

6.1 Indoor Unit PCB Abnormality

Error Code	A1
Method of Error Detection	The system checks the data from EEPROM.
Error Decision Conditions	When the data from the EEPROM is not received correctly EEPROM (Electrically Erasable Programmable Read Only Memory): A memory chip that holds its content without power. It can be erased, either within the computer or externally and usually requires more voltage for erasure than the common +5 volts used in logic circuits. It functions like non-volatile RAM, but writing to EEPROM is slower than writing to RAM.
Supposed Causes	<ul style="list-style-type: none"> ■ Defective indoor unit PCB ■ External factor (noise etc.)

Troubleshooting

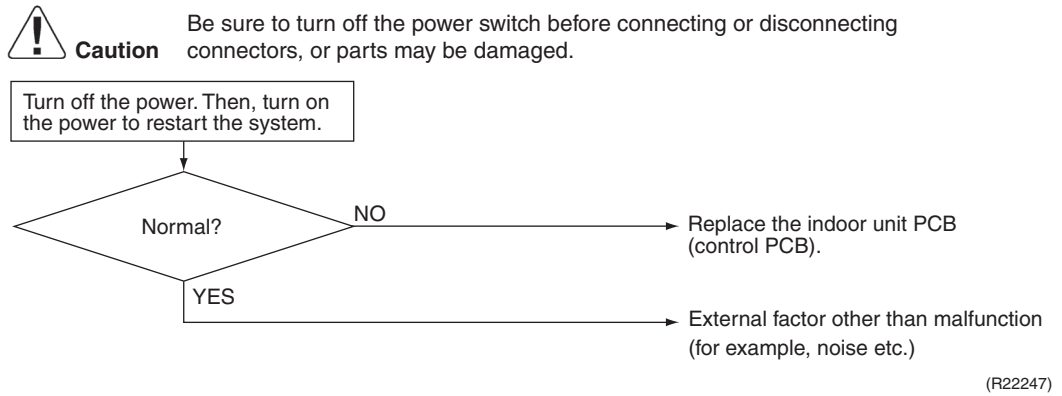

6.2 Drain Level Control System Abnormality

Error Code	A3
Method of Error Detection	The float switch detects error.
Error Decision Conditions	When the water level reaches its upper limit and when the float switch turns OFF
Supposed Causes	<ul style="list-style-type: none"> ■ Defective drain pump ■ Improper drain piping work ■ Clogged drain piping ■ Defective float switch ■ Defective indoor unit PCB ■ Defective short circuit connector X15A, X25A on indoor unit PCB

Troubleshooting

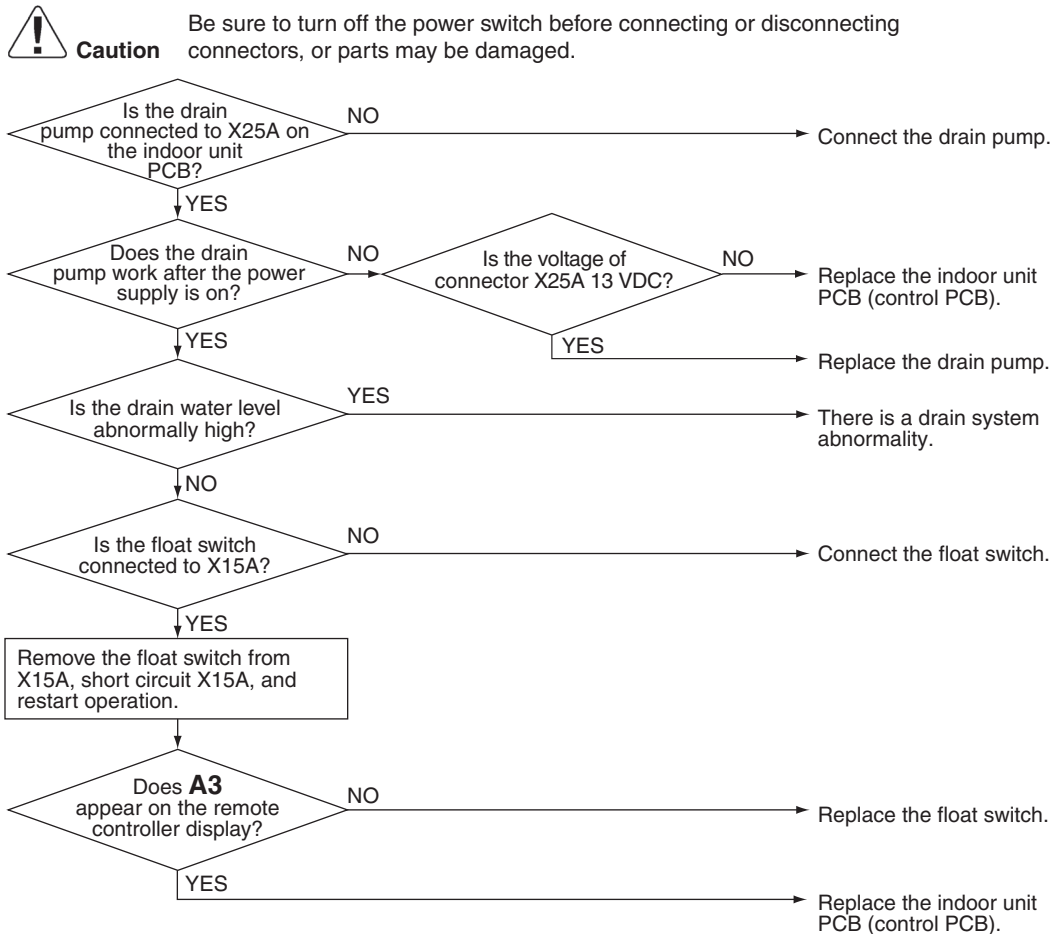

(R25079)

6.3 Indoor Fan Motor (DC Motor) or Related Abnormality

Error Code	A6
Method of Error Detection	<ul style="list-style-type: none"> ■ Detection from the current flow on the fan PCB ■ Detection from the rotation speed of the fan motor in operation
Error Decision Conditions	The rotation speed is less than a certain level for 6 seconds.
Supposed Causes	<ul style="list-style-type: none"> ■ Clogged foreign matter ■ Disconnection of fan motor connectors ■ Disconnection of the connector between the indoor unit PCB and the fan PCB ■ Defective fan PCB ■ Defective fan motor ■ No fuse continuity

Trouble Shooting



Caution

Be sure to turn off the power switch before connecting or disconnecting connectors, or parts may be damaged.

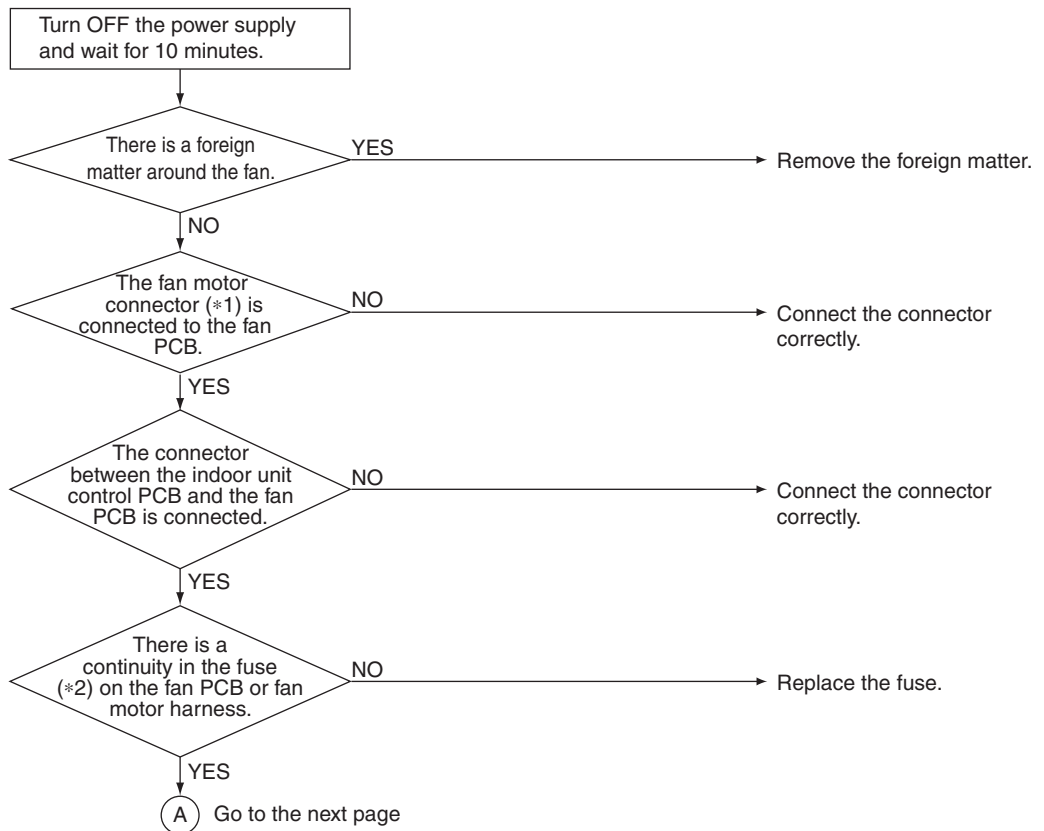

R6000547

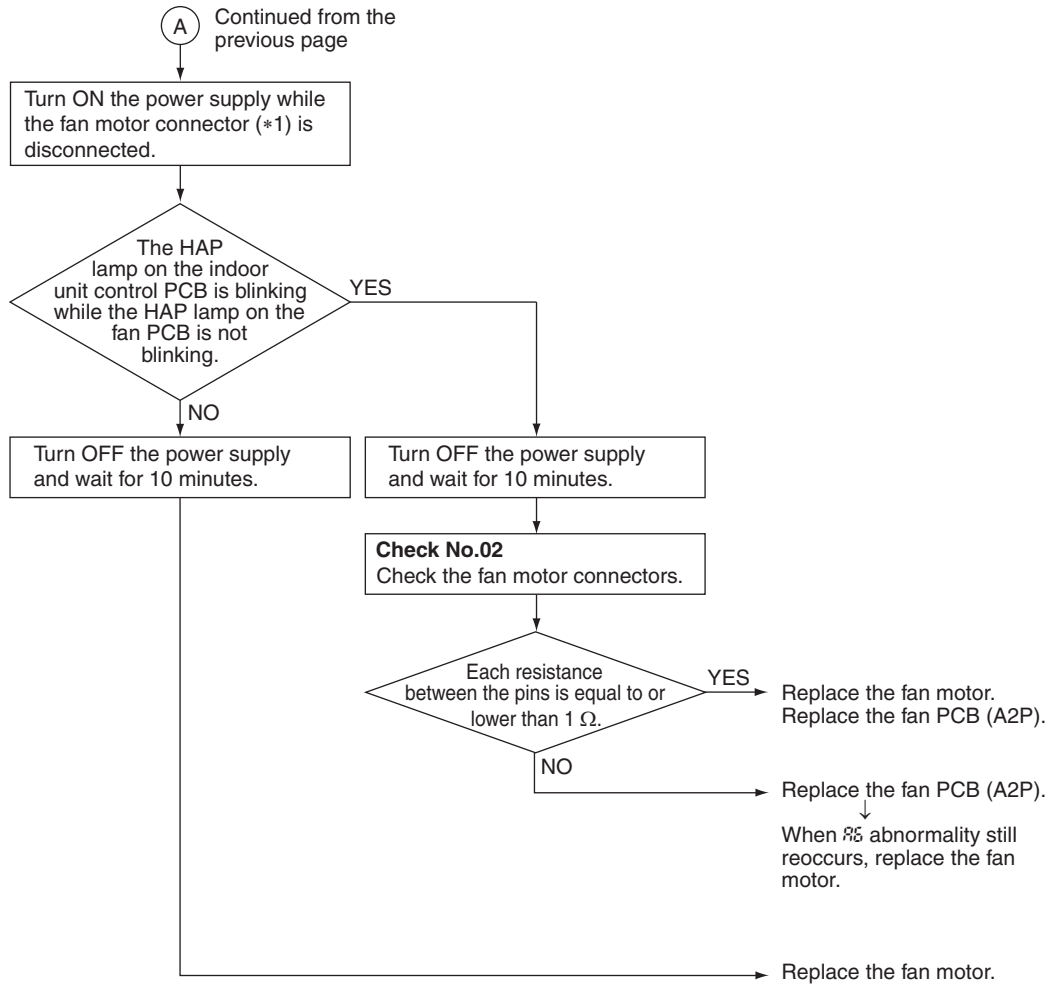

R6000548

i Note

Connector and indoor unit PCB

Model	*1 Fan motor connector	*2 Fuse
FDMQ Series	X8A	F2U

📄 Reference

Check No.02 Refer to P.187

6.4 Indoor Fan PCB Abnormality

Error Code	A8
Method of Error Detection	Microcomputer checks the voltage state of the fan PCB.
Error Decision Conditions	Overvoltage or voltage drop is detected on the fan PCB.
Supposed Causes	<ul style="list-style-type: none"> ■ Defective fan PCB ■ External factor such as noise

Troubleshooting

 **Caution** Be sure to turn off the power switch before connecting or disconnecting connectors, or parts may be damaged.

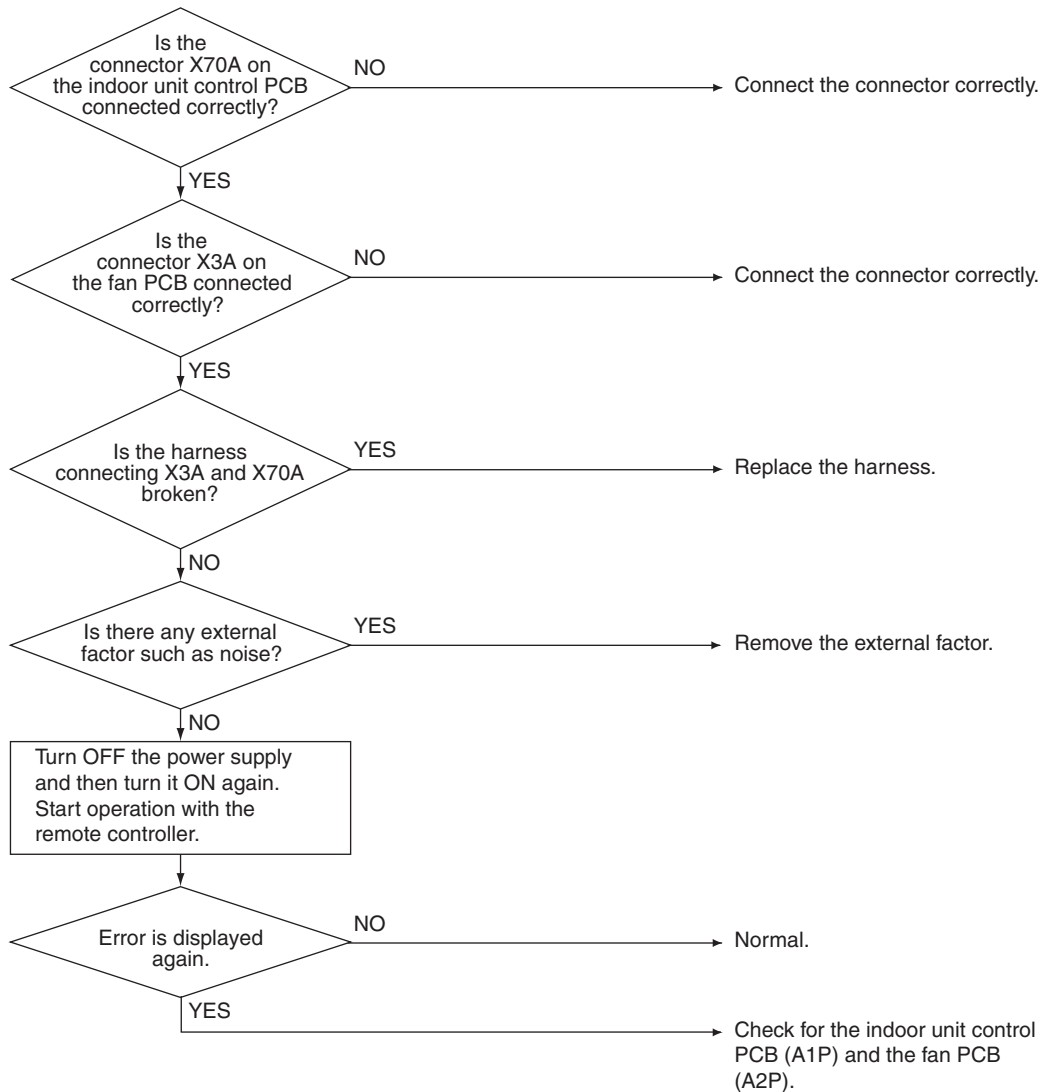

R6000549

6.5 Humidifier or Related Abnormality

Error Code

AF

Method of Error Detection

Water leakage from humidifier(s) is detected based on the float switch ON/OFF changeover while the system is not operating.

Error Decision Conditions

The float switch changes from ON to OFF while the system is OFF

Supposed Causes

- Defective float switch
- Error in water drain system of humidifier(s)
- Clogged electric expansion valve in humidifier(s)
- Defective indoor unit PCB

Troubleshooting



Caution

Be sure to turn off the power switch before connecting or disconnecting connectors, or parts may be damaged.

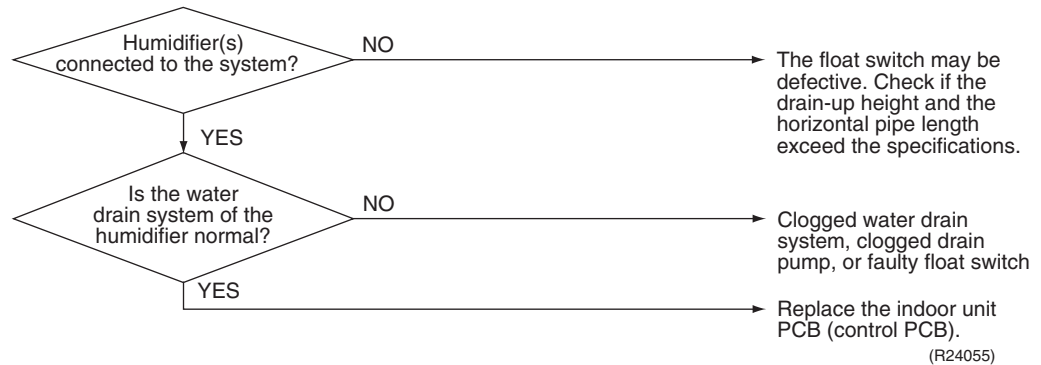

Note

The system continues to operate with the thermostat OFF even while the error code is displayed.

6.6 Thermistor or Related Abnormality

Error Code	C4, C5, C9
Method of Error Detection	The temperatures detected by the thermistors determine thermistor errors.
Error Decision Conditions	The thermistor is disconnected or shorted while the unit is running.
Supposed Causes	<ul style="list-style-type: none"> ■ Disconnection of connector ■ Defective thermistor(s) ■ Breaking of wires ■ Defective indoor unit PCB
Troubleshooting	<p>If the cause of the problem is related to the thermistors, the thermistors should be checked prior to changing the indoor unit PCB.</p> <p>To check the thermistors, proceed as follows:</p> <ol style="list-style-type: none"> 1. Disconnect the thermistor from the indoor unit PCB. 2. Read the temperature and the resistance value. 3. Check if the measured values correspond with the values in the table of thermistor resistance check.

 **Caution** Be sure to turn off the power switch before connecting or disconnecting connectors, or parts may be damaged.

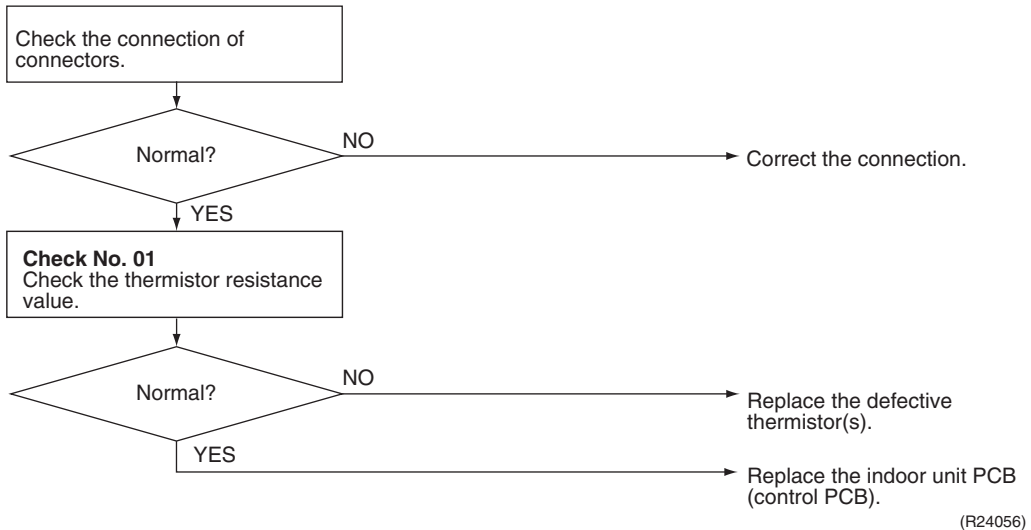

- C4:** Indoor heat exchanger thermistor 1 (liquid pipe) (R2T)
- C5:** Indoor heat exchanger thermistor 2 (R3T)
- C9:** Room temperature thermistor (R1T)



Reference

Check No.01 Refer to P.186

6.7 Remote Controller Thermistor Abnormality

Error Code

CJ

Method of Error Detection

Even if remote controller thermistor is faulty, system is possible to operate by system thermistor. Malfunction detection is carried out by the temperature detected by the remote controller thermistor.

Error Decision Conditions

The remote controller thermistor is disconnected or shorted while the unit is running.

Supposed Causes

- Defective room temperature thermistor in the wired remote controller
- Defective wired remote controller PCB
- External factor such as noise

Troubleshooting

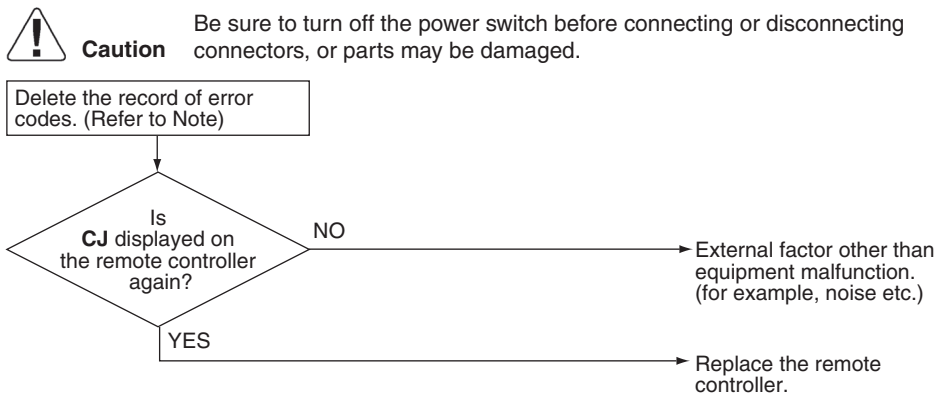

Note

To delete the record of error codes, press **ON/OFF** button on the remote controller for 4 seconds or more while the error code is displayed in the inspection mode.

6.8 Low-voltage Detection or Over-voltage Detection

Error Code	U2
Method of Error Detection	<p>Low-voltage detection: An abnormal voltage drop is detected by the DC voltage detection circuit.</p> <p>Over-voltage detection: An abnormal voltage rise is detected by the over-voltage detection circuit.</p>
Error Decision Conditions	<p>Low-voltage detection:</p> <ul style="list-style-type: none"> ■ The voltage detected by the DC voltage detection circuit is below 150 ~ 200 V (depending on the model). ■ The compressor stops if the error occurs, and restarts automatically after 3-minute standby. <p>Over-voltage detection:</p> <ul style="list-style-type: none"> ■ An over-voltage signal is fed from the over-voltage detection circuit to the microcomputer (over 458 ~ 500 V, depending on the model). ■ The compressor stops if the error occurs, and restarts automatically after 3-minute standby.
Supposed Causes	<ul style="list-style-type: none"> ■ Power supply voltage out of specification ■ Defective DC voltage detection circuit ■ Defective over-voltage detection circuit ■ Defective PAM control part ■ Disconnection of compressor harness ■ Short circuit inside the fan motor winding ■ Noise ■ Momentary drop of voltage ■ Momentary power failure ■ Defective outdoor unit PCB

Troubleshooting

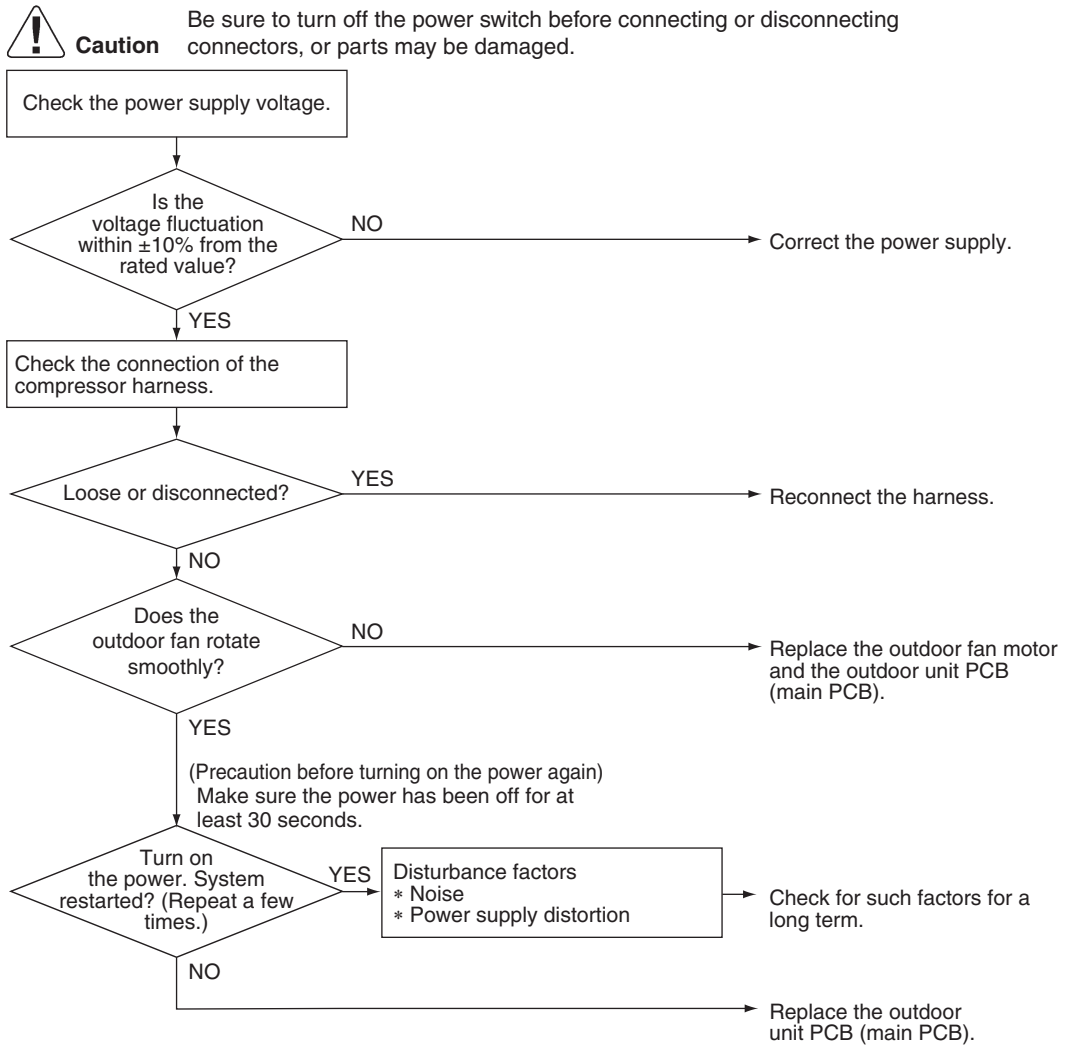

(R22445)

6.9 Signal Transmission Error (Between Indoor and Outdoor Unit)

Error Code	U4
Method of Error Detection	The signal transmission data from the outdoor unit is checked whether it is normal.
Error Decision Conditions	The data sent from the outdoor unit cannot be received normally, or the content of the data is abnormal.
Supposed Causes	<ul style="list-style-type: none">■ Power supply voltage out of specification■ Reduction of power supply voltage■ Wiring error■ Breaking of the connection wires between the indoor and outdoor units (wire No. 3)■ Defective outdoor unit PCB■ Short circuit inside the fan motor winding■ Defective indoor unit PCB■ Disturbed power supply waveform

Troubleshooting

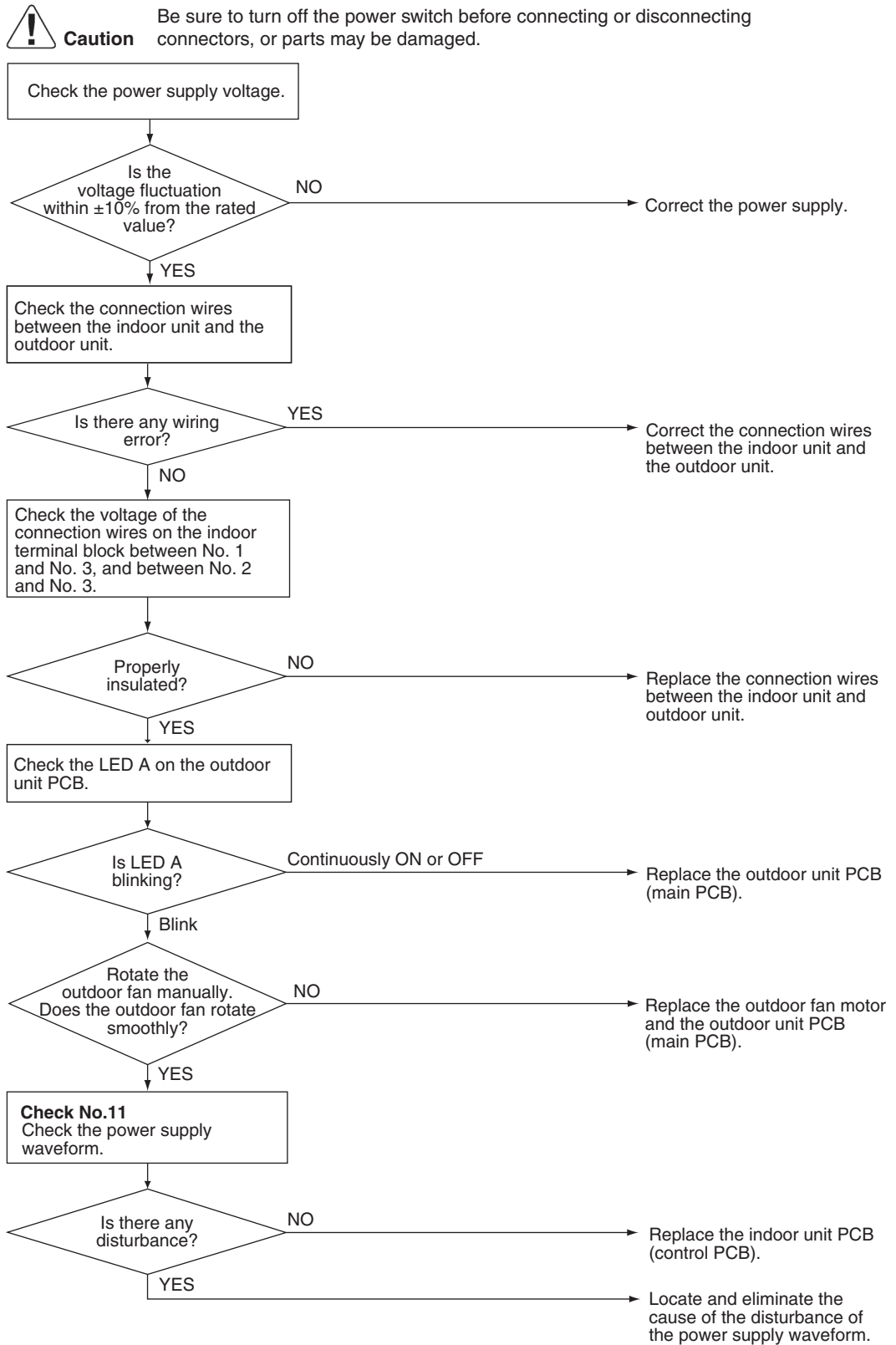

(R24622)



Reference

Check No.11 Refer to P.189

6.10 Signal Transmission Error (Between Indoor Unit and Remote Controller)

Error Code

U5

Method of Error Detection

In case of controlling 1 indoor unit with 2 remote controllers, check the system using microcomputer if signal transmission between indoor unit and remote controller (main and sub) is normal.

Error Decision Conditions

Normal transmission does not continue for specified period.

Supposed Causes

- Connection of 2 main remote controllers (when using 2 remote controllers)
- Defective indoor unit PCB
- Defective remote controller
- Transmission error caused by noise

Troubleshooting

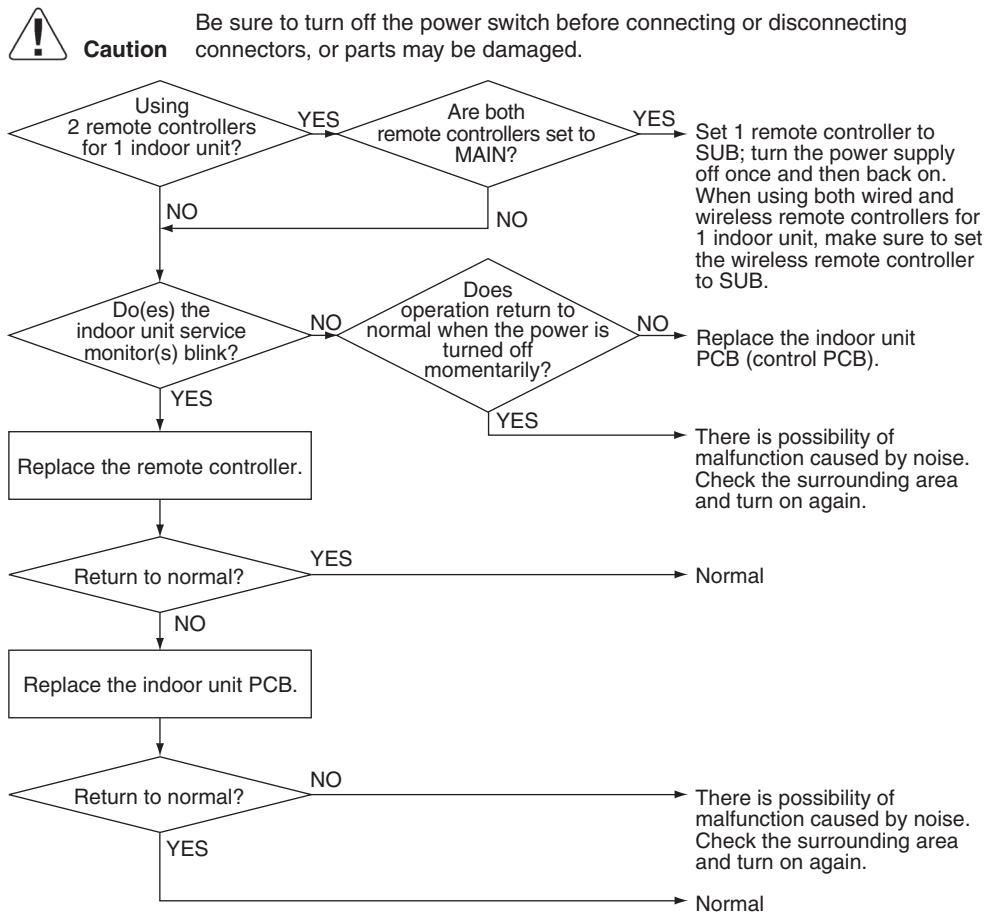

(R24590)



Note

For the way to change MAIN/SUB setting of remote controllers, refer to page 225.

6.11 Signal Transmission Error (Between MAIN/SUB Remote Controllers)

Error Code	U8
Method of Error Detection	In case of controlling 1 indoor unit with 2 remote controllers, check the system using microcomputer if signal transmission between MAIN remote controller and SUB remote controller is normal.
Error Decision Conditions	Normal transmission does not continue for specified period.
Supposed Causes	<ul style="list-style-type: none"> ■ Remote controller is set to SUB when using 1 remote controller ■ Connection of 2 SUB remote controllers (when using 2 remote controllers) ■ Defective remote controller PCB

Troubleshooting

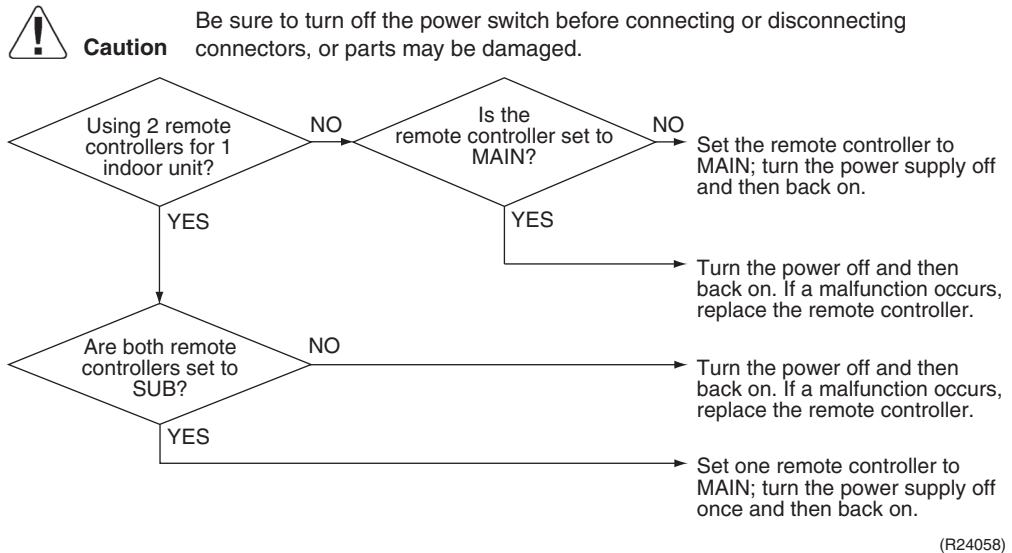

Note

For the way to change MAIN/SUB setting of remote controllers, refer to page 225.

6.12 Mismatching of Indoor Unit and Outdoor Unit

Error Code

UA

Error Decision Conditions

Improper combination of indoor and outdoor units

Supposed Causes

- Defective indoor unit PCB
- Indoor-outdoor unit transmission wiring error
- Defective optional unit(s) wirings
- Improper power supply wiring of indoor unit
- Improper wiring of connecting wires between indoor/outdoor units

Troubleshooting



Caution

Be sure to turn off the power switch before connecting or disconnecting connectors, or parts may be damaged.

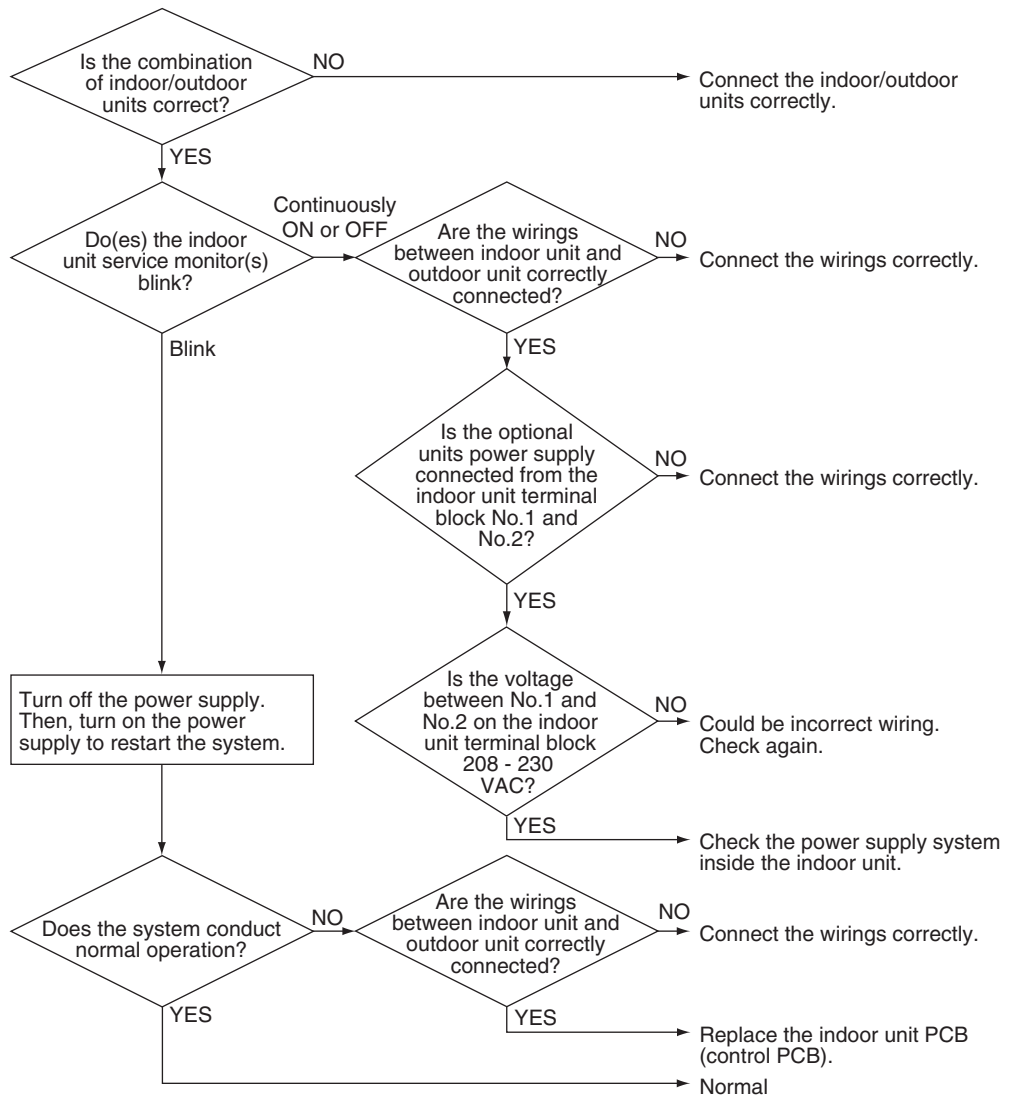

(R24591)

7. Troubleshooting for Outdoor Unit

7.1 Outdoor Unit PCB Abnormality

Error Code

E1

Method of Error Detection

- The system checks if the microprocessor is working in order.
- The system checks if the zero-cross signal comes in properly.

Error Decision Conditions

- The microprocessor program runs out of control.
- The zero-cross signal is not detected.

Supposed Causes

- Defective outdoor unit PCB
- Noise
- Momentary drop of voltage
- Momentary power failure

Troubleshooting

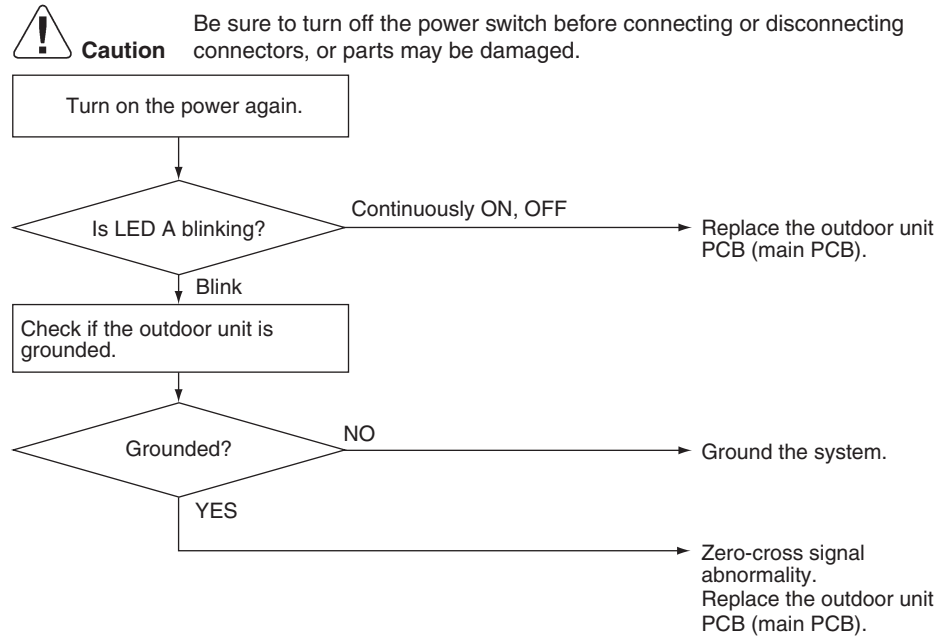

(R24717)

7.2 Actuation of High Pressure Switch

Applicable Models	RXL15/18/24WMVJU9
Error Code	E3
Method of Error Detection	Abnormality is detected when the contact of the high pressure switch opens.
Error Decision Conditions	<ul style="list-style-type: none"> ■ High pressure switch (S1PH) activating pressure: 4.15 MPa (602 psi) ■ High pressure switch (S1PH) recovery pressure: 3.2 MPa (464 psi)
Supposed Causes	<ul style="list-style-type: none"> ■ Actuation of high pressure switch (S1PH) ■ Closed stop valve ■ Disconnection of connector S40 ■ Disconnection of 2 terminals of high pressure switch (S1PH) ■ Defective outdoor unit PCB ■ Broken S1PH harness ■ Defective high pressure switch (S1PH)

Troubleshooting



Caution Be sure to turn off the power switch before connecting or disconnecting connectors, or parts may be damaged.

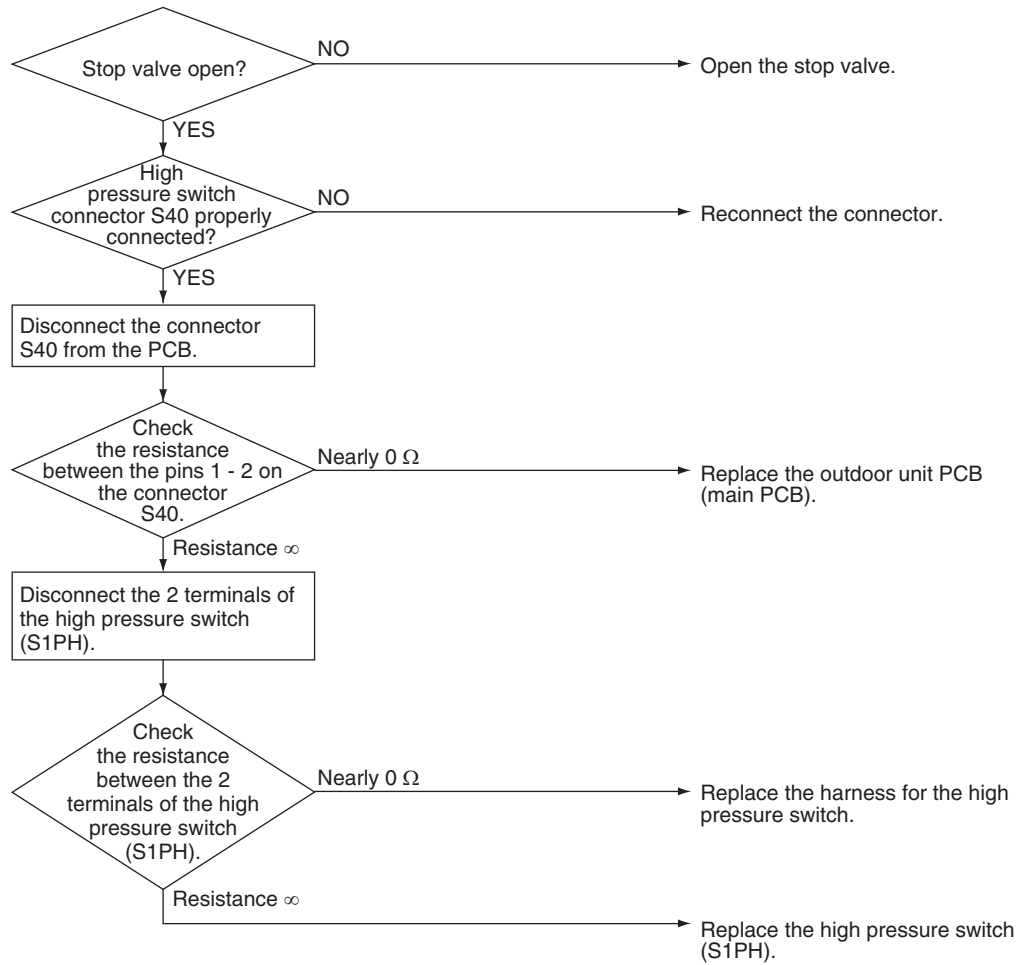

(R22435)

7.3 OL Activation (Compressor Overload) or HPS Activation (High Pressure Switch)

Applicable Models	RXL09/12WMVJU9
Error Code	E5
Method of Error Detection	A compressor overload is detected through compressor OL. Abnormality is detected when the contact of the high pressure switch opens.
Error Decision Conditions	<ul style="list-style-type: none"> ■ If the error repeats, the system is shut down. ■ Reset condition: Continuous run for about 60 minutes without any other error
Supposed Causes	<ul style="list-style-type: none"> ■ Disconnection of discharge pipe thermistor ■ Disconnection of indoor or outdoor heat exchanger thermistor ■ Defective discharge pipe thermistor ■ Defective indoor or outdoor heat exchanger thermistor ■ Disconnection of connector S40 ■ Disconnection of 2 terminals of OL (Q1M/Q1L) ■ Disconnection of 2 terminals of HPS (S1PH) ■ Defective OL (Q1M/Q1L) ■ Defective HPS (S1PH) ■ Broken OL and HPS harness ■ Defective electronic expansion valve or coil ■ Defective four way valve or coil ■ Defective outdoor unit PCB ■ Refrigerant shortage ■ Water mixed in refrigerant ■ Defective stop valve

Troubleshooting



Caution Be sure to turn off the power switch before connecting or disconnecting connectors, or parts may be damaged.

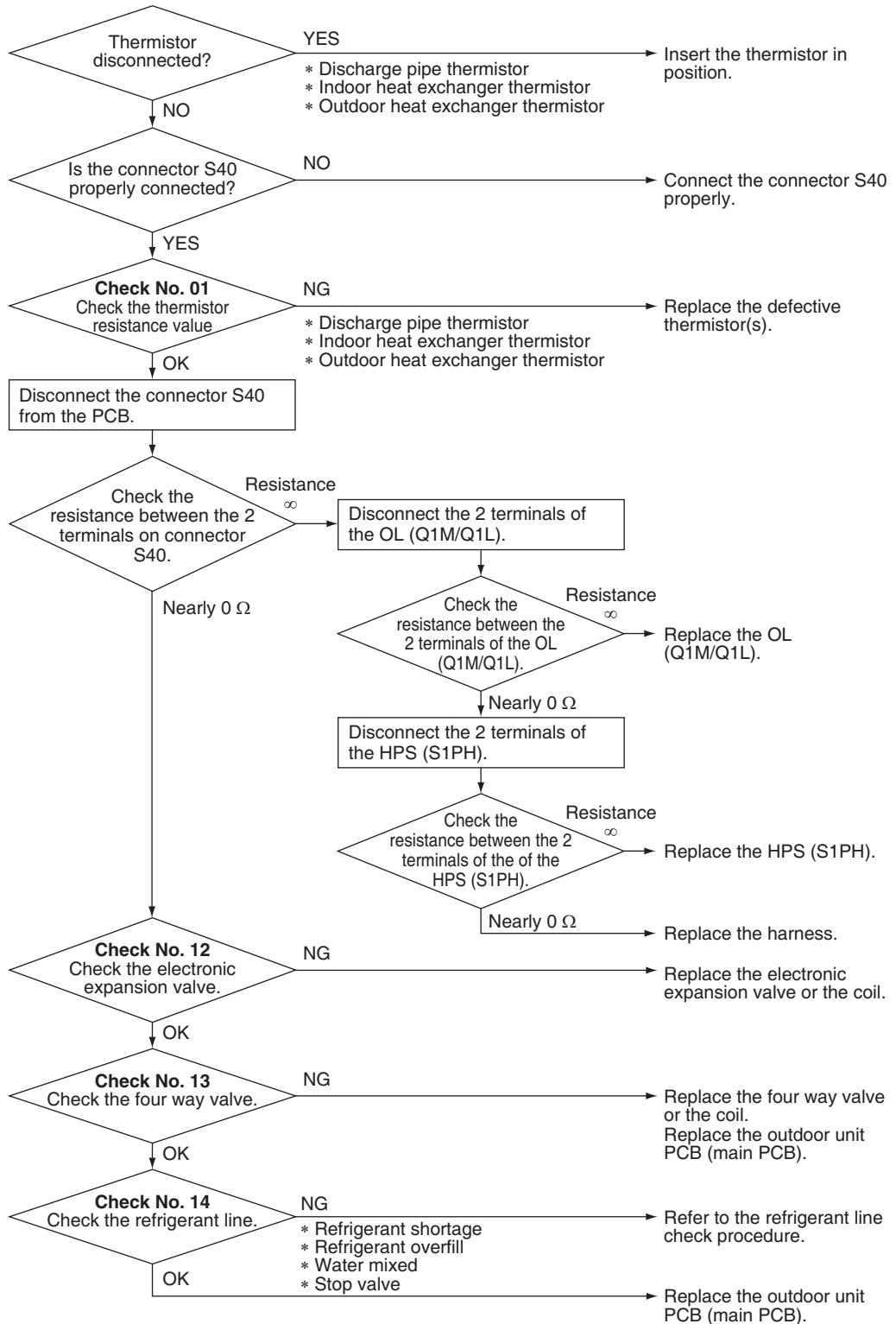

R6000967

**Note(s)**

OL (Q1M/Q1L) activating temperature: 130°C (266°F)
OL (Q1M/Q1L) recovery temperature: 95°C (203°F)
High pressure switch (S1PH) activating pressure: 602 psi (4.15 MPa)
High pressure switch (S1PH) recovery pressure: 464 psi (3.2 MPa)

**Reference**

Check No.01 Refer to P.186

**Reference**

Check No.12 Refer to P.189

**Reference**

Check No.13 Refer to P.190

**Reference**

Check No.14 Refer to P.192

7.4 OL Activation (Compressor Overload)

Applicable Models	RXL15/18/24WMVJU9
Error Code	E5
Method of Error Detection	A compressor overload is detected through compressor OL.
Error Decision Conditions	<ul style="list-style-type: none">■ If the error repeats, the system is shut down.■ Reset condition: Continuous run for about 60 minutes without any other error
Supposed Causes	<ul style="list-style-type: none">■ Disconnection of discharge pipe thermistor■ Defective discharge pipe thermistor■ Disconnection of connector S40■ Disconnection of 2 terminals of OL (Q1M)■ Defective OL (Q1M)■ Broken OL harness■ Defective electronic expansion valve or coil■ Defective four way valve or coil■ Defective outdoor unit PCB■ Refrigerant shortage■ Water mixed in refrigerant■ Defective stop valve

Troubleshooting



Caution Be sure to turn off the power switch before connecting or disconnecting connectors, or parts may be damaged.

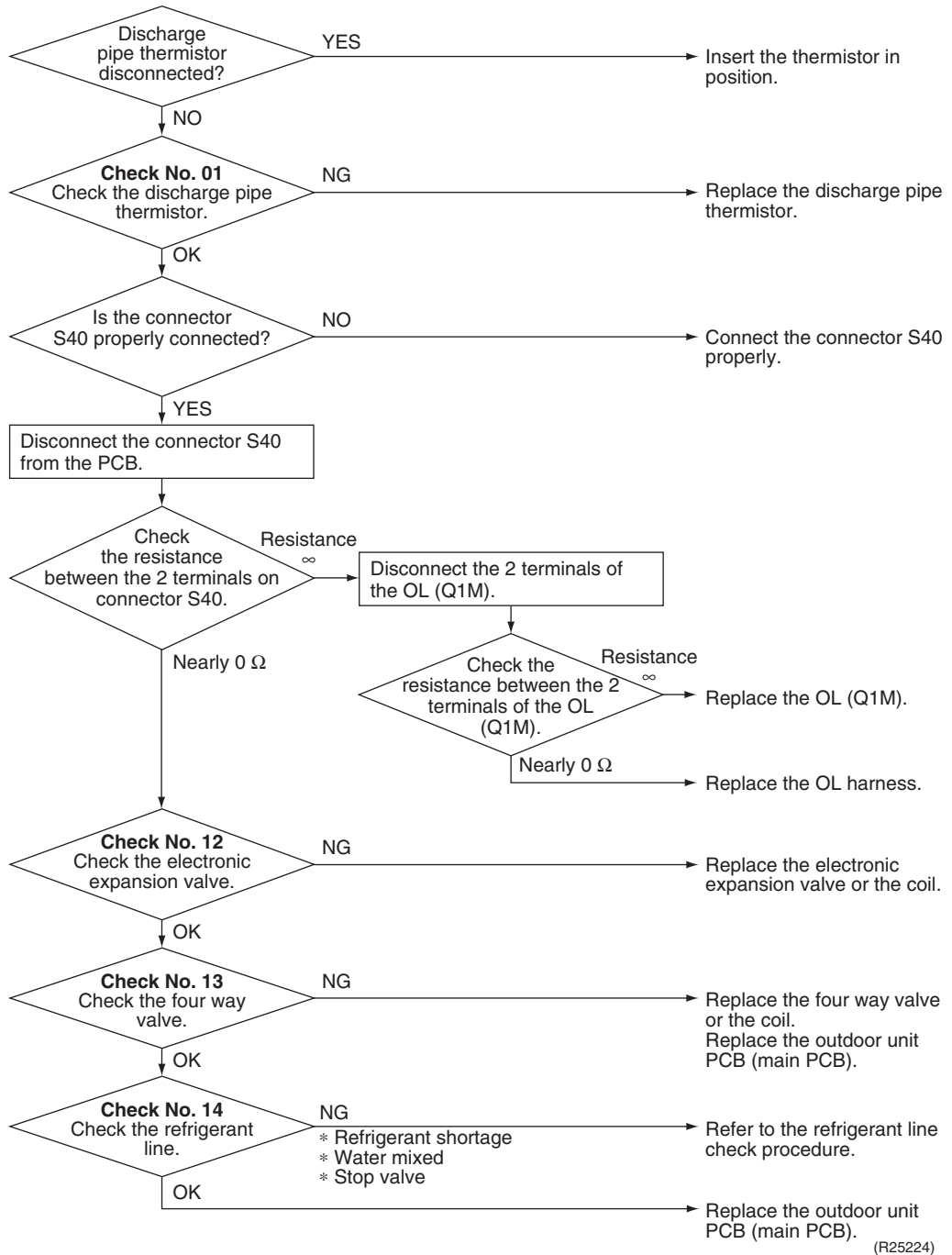

Note OL (Q1M) activating temperature: 130°C (266°F)
OL (Q1M) recovery temperature: 95°C (203°F)



Reference **Check No.01** Refer to P.186



Reference **Check No.12** Refer to P.189



Reference **Check No.13** Refer to P.190



Reference **Check No.14** Refer to P.192

7.5 Compressor Lock

Error Code	E6
Method of Error Detection	A compressor lock is detected by the current waveform generated when applying high-frequency voltage to the motor.
Error Decision Conditions	<ul style="list-style-type: none"> ■ If the error repeats, the system is shut down. ■ Reset condition: Continuous run for about 11 minutes without any other error
Supposed Causes	<ul style="list-style-type: none"> ■ Closed stop valve ■ Compressor locked ■ Disconnection of compressor harness

Troubleshooting

 **Caution** Be sure to turn off the power switch before connecting or disconnecting connectors, or parts may be damaged.
 (Precaution before turning on the power again)
 Make sure the power has been off for at least 30 seconds.

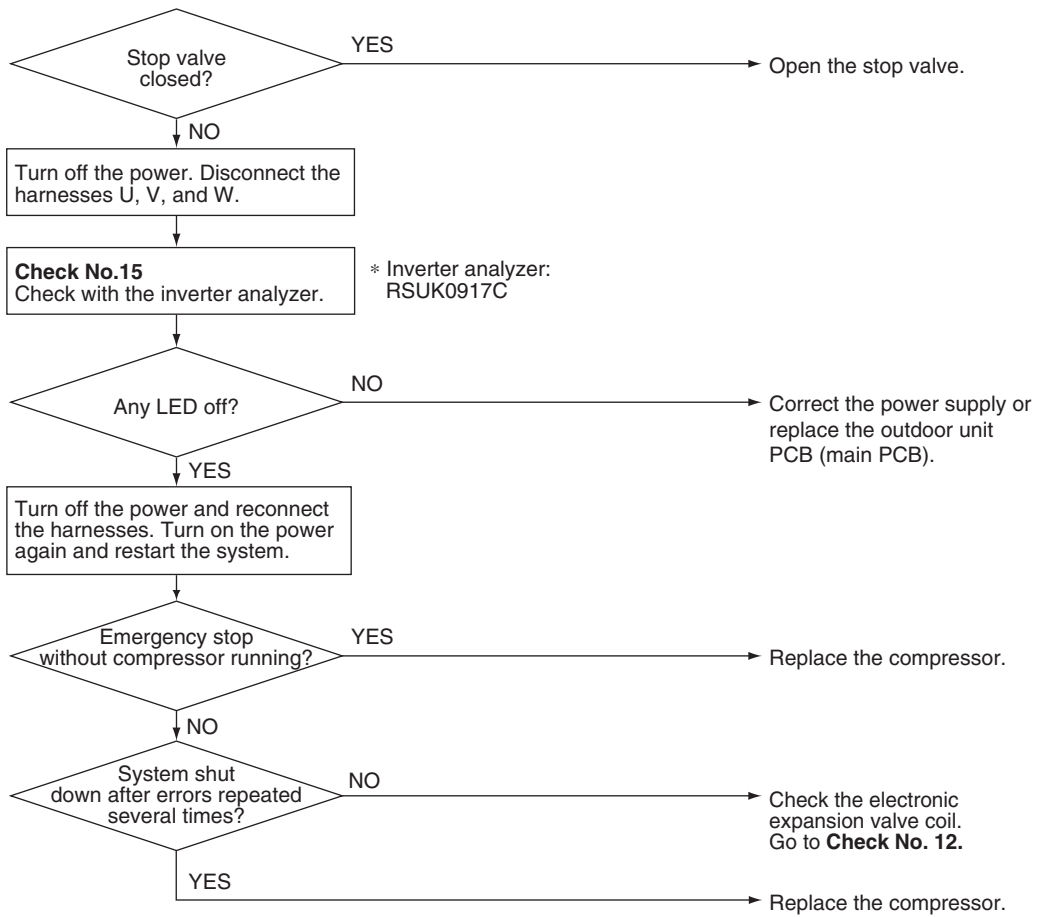

(R21067)

 **Reference** **Check No.12** Refer to P.189

 **Reference** **Check No.15** Refer to P.193

7.6 DC Fan Lock

Error Code

E7

Method of Error Detection

An error is determined with the high-voltage fan motor rotation speed detected by the Hall IC.

Error Decision Conditions

- The fan does not start in 15 ~ 30 seconds even when the fan motor is running.
- If the error repeats, the system is shut down.
- Reset condition: Continuous run for about 11 minutes without any other error

Supposed Causes

- Disconnection of the fan motor
- Foreign matter stuck in the fan
- Defective fan motor
- Defective outdoor unit PCB

Troubleshooting

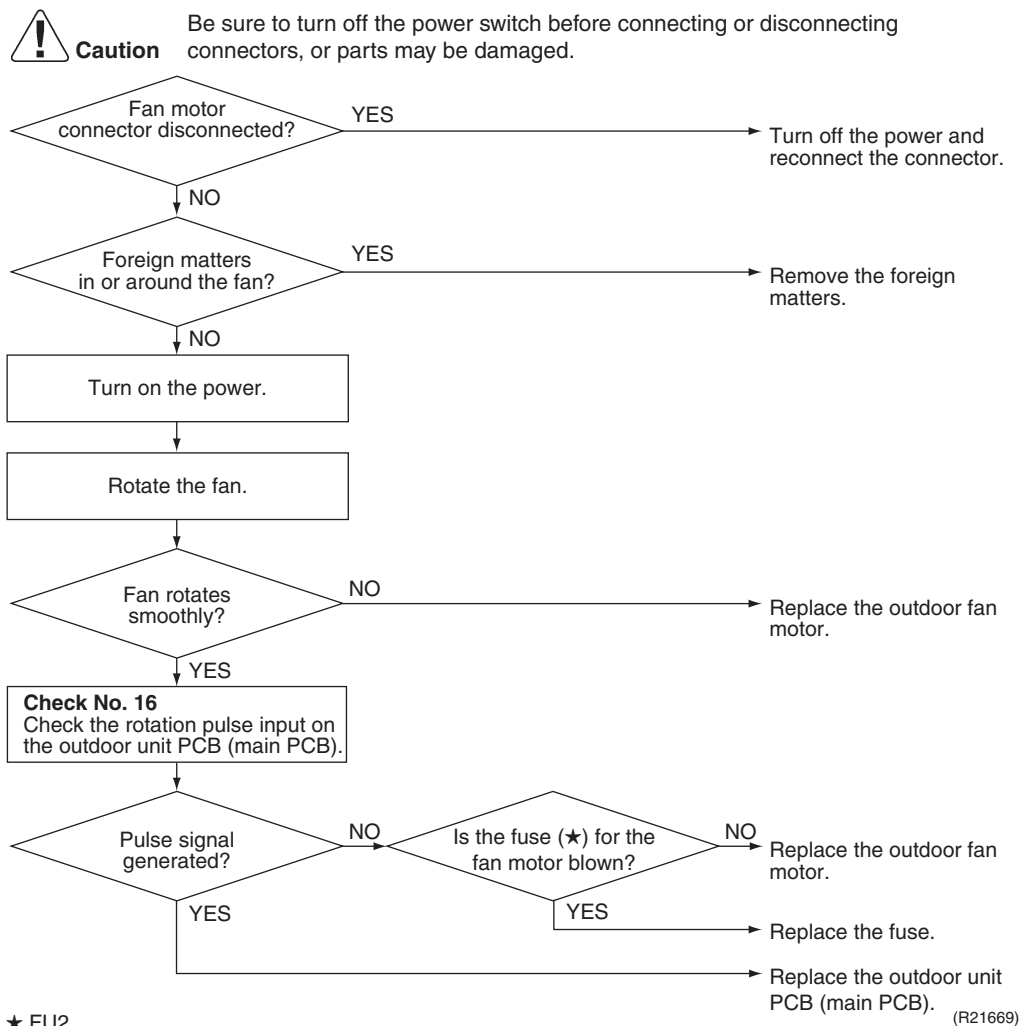

Reference

Check No.16 Refer to P.196

7.7 Input Overcurrent Detection

Error Code	E8
Method of Error Detection	An input overcurrent is detected by checking the input current value with the compressor running.
Error Decision Conditions	The current exceeds about 12.0 ~ 20.0 A (depending on the model) for 2.5 seconds with the compressor running. The upper limit of the current decreases when the outdoor temperature exceeds a certain level.
Supposed Causes	<ul style="list-style-type: none"> ■ Outdoor temperature is out of operation range. ■ Defective compressor ■ Defective power module ■ Defective outdoor unit PCB ■ Short circuit

Troubleshooting



Caution Be sure to turn off the power switch before connecting or disconnecting connectors, or parts may be damaged.

* An input overcurrent may result from wrong internal wiring. If the system is interrupted by an input overcurrent after the wires have been disconnected and reconnected for part replacement, check the wiring again.

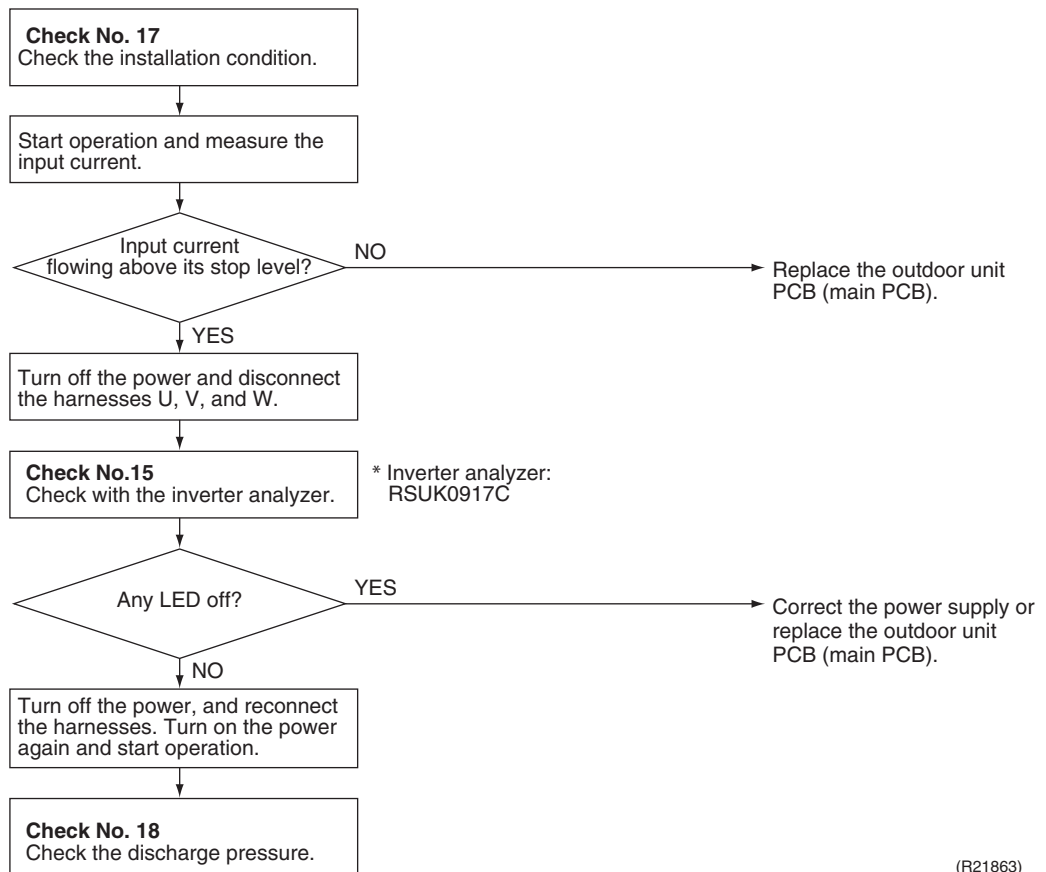

(R21863)



Reference Check No.15 Refer to P.193



Reference Check No.17 Refer to P.197



Reference

Check No.18 Refer to P.197

7.8 Four Way Valve Abnormality

Error Code	EA																											
Method of Error Detection	The room temperature thermistor and the indoor heat exchanger thermistor are checked if they function within their normal ranges in each operation mode.																											
Error Decision Conditions	<p>The following condition continues over C seconds after operating for 5 minutes.</p> <ul style="list-style-type: none"> ■ Cooling/Dry <ul style="list-style-type: none"> A – B < –5°C (A – B < –9°F) ■ Heating <ul style="list-style-type: none"> B – A < –5°C (B – A < –9°F) <p>A: Room thermistor temperature B: Indoor heat exchanger temperature</p> <table border="1" style="width: 100%; border-collapse: collapse; text-align: center;"> <thead> <tr> <th rowspan="2">Outdoor temperature</th> <th colspan="5">C (seconds)</th> </tr> <tr> <th>09 class</th> <th>12 class</th> <th>15 class</th> <th>18 class</th> <th>24 class</th> </tr> </thead> <tbody> <tr> <td>–15°C (5°F) or higher</td> <td>300</td> <td>300</td> <td>300</td> <td>300</td> <td>300</td> </tr> <tr> <td>Lower than –15°C (5°F)</td> <td>600</td> <td>300</td> <td>1400</td> <td>1400</td> <td>1400</td> </tr> </tbody> </table>					Outdoor temperature	C (seconds)					09 class	12 class	15 class	18 class	24 class	–15°C (5°F) or higher	300	300	300	300	300	Lower than –15°C (5°F)	600	300	1400	1400	1400
Outdoor temperature	C (seconds)																											
	09 class	12 class	15 class	18 class	24 class																							
–15°C (5°F) or higher	300	300	300	300	300																							
Lower than –15°C (5°F)	600	300	1400	1400	1400																							
Supposed Causes	<ul style="list-style-type: none"> ■ If the error repeats, the system is shut down. ■ Reset condition: Continuous run for about 60 minutes without any other error <hr/> <ul style="list-style-type: none"> ■ Disconnection of four way valve coil ■ Defective four way valve, coil, or harness ■ Defective outdoor unit PCB ■ Defective thermistor(s) ■ Refrigerant shortage ■ Water mixed in refrigerant ■ Defective stop valve 																											

Troubleshooting



Caution Be sure to turn off the power switch before connecting or disconnecting connectors, or parts may be damaged.

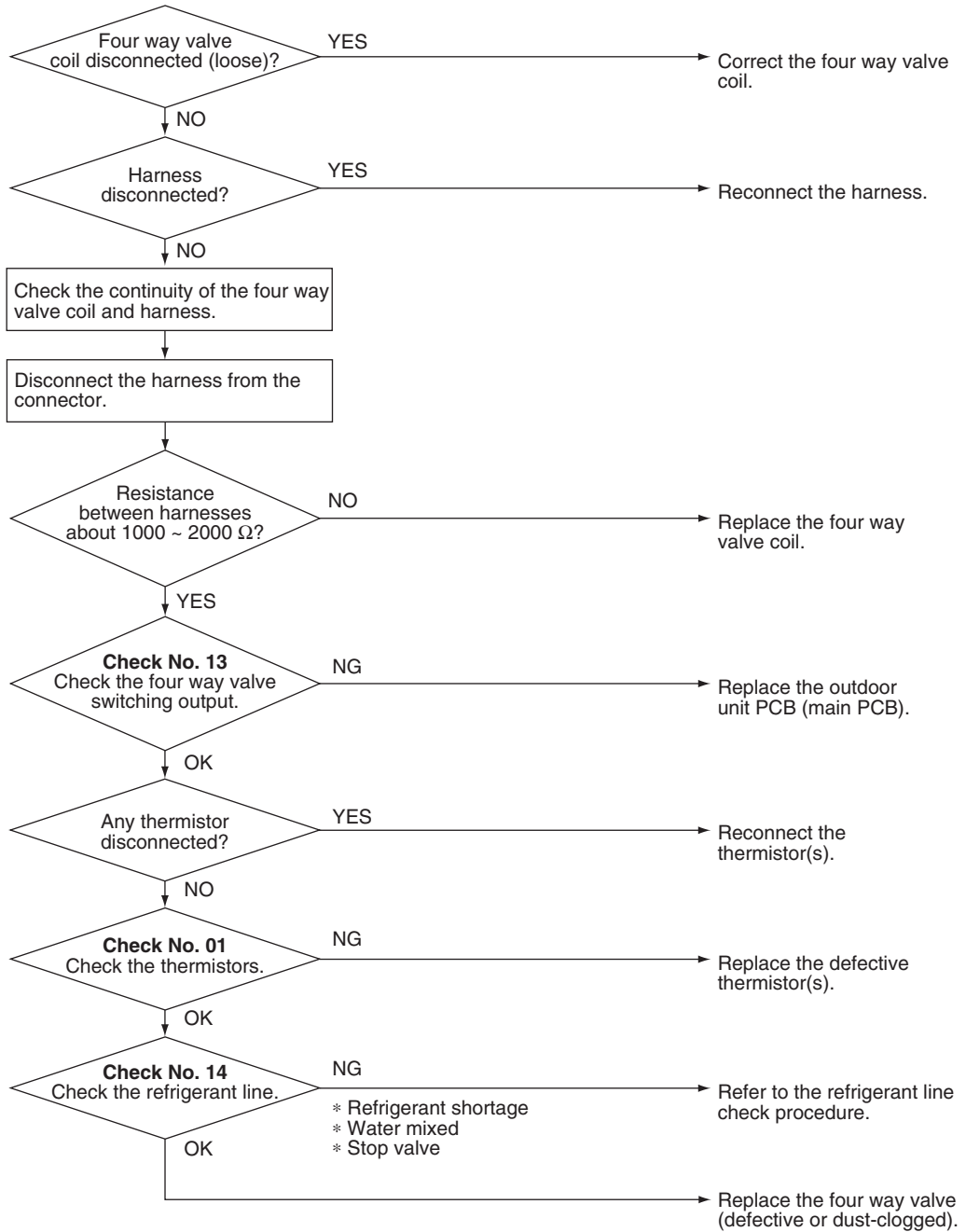

(R20405)



Reference Check No.01 Refer to P.186



Reference Check No.13 Refer to P.190



Reference Check No.14 Refer to P.192

7.9 Discharge Pipe Temperature Control

Error Code **F3**

Method of Error Detection An error is determined with the temperature detected by the discharge pipe thermistor.

- Error Decision Conditions**
- If the temperature detected by the discharge pipe thermistor rises above **A**, the compressor stops.
 - The error is cleared when the discharge pipe temperature has dropped below **B**.
 - If the error repeats, the system is shut down.
 - Reset condition: Continuous run for about 60 minutes without any other error

	A		B	
	°C	°F	°C	°F
09 class	110	230	88	190.4
12/18/24 class	120	248	107	224.6
15 class	110	230	95	203



★ If the frequency drops, the temperature is lowered in compensation.

- Supposed Causes**
- Defective discharge pipe thermistor (Defective outdoor heat exchanger thermistor or outdoor temperature thermistor)
 - Defective electronic expansion valve or coil
 - Refrigerant shortage
 - Defective four way valve
 - Water mixed in refrigerant
 - Defective stop valve
 - Defective outdoor unit PCB

Troubleshooting

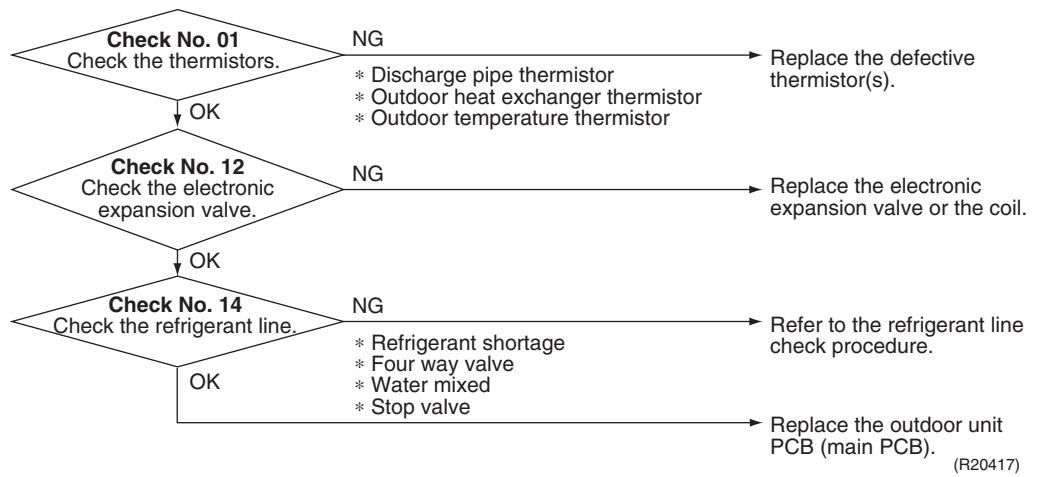
 **Caution** Be sure to turn off the power switch before connecting or disconnecting connectors, or parts may be damaged.



-  **Reference** **Check No.01** Refer to P.186
-  **Reference** **Check No.12** Refer to P.189
-  **Reference** **Check No.14** Refer to P.192

7.10 High Pressure Control in Cooling

Error Code	F6
Method of Error Detection	High-pressure control (operation halt, frequency drop, etc.) is activated in cooling operation if the temperature sensed by the outdoor heat exchanger thermistor exceeds the limit.
Error Decision Conditions	<ul style="list-style-type: none">■ The temperature sensed by the outdoor heat exchanger thermistor rises above 60 ~ 62°C (140 ~ 143.6°F) (depending on the model).■ The error is cleared when the temperature drops below 48.5 ~ 52°C (119.3 ~ 125.6°F) (depending on the model).
Supposed Causes	<ul style="list-style-type: none">■ Installation space not large enough■ Dirty outdoor heat exchanger■ Defective outdoor fan motor■ Defective stop valve■ Defective electronic expansion valve or coil■ Defective outdoor heat exchanger thermistor■ Defective outdoor unit PCB

Troubleshooting



Caution Be sure to turn off the power switch before connecting or disconnecting connectors, or parts may be damaged.

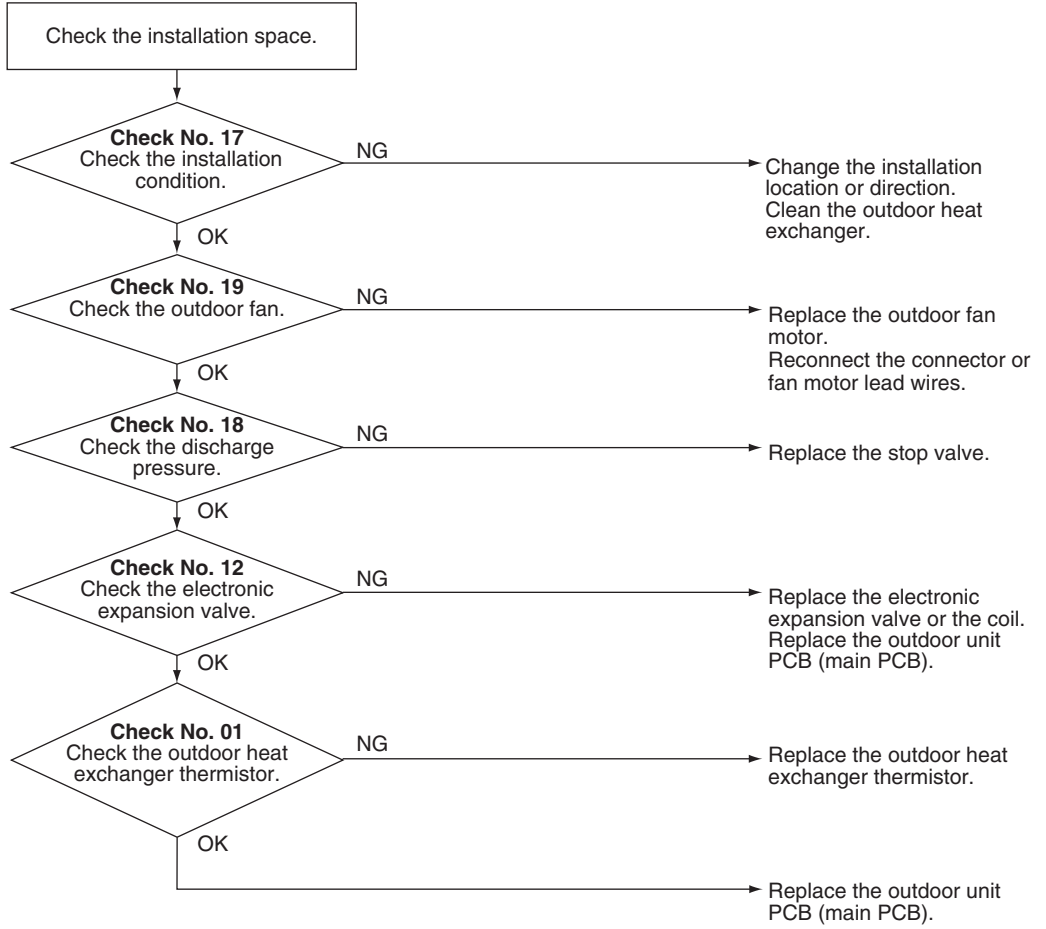

(R20418)



Reference Check No.01 Refer to P.186



Reference Check No.12 Refer to P.189



Reference Check No.17 Refer to P.197



Reference Check No.18 Refer to P.197



Reference Check No.19 Refer to P.198

7.11 System Shutdown due to Temperature Abnormality in the Compressor

Error Code

F8

Method of Error Detection

Operation is halted when the temperature detected by the discharge pipe thermistor exceeds the determined limit.

Error Decision Conditions

Temperature exceeds the detection threshold of 127.5°C (261.5°F) during forced cooling operation.

Supposed Causes

- Abnormal operation due to air intrusion
- Defective discharge pipe thermistor

Troubleshooting



Caution

Be sure to turn off the power switch before connecting or disconnecting connectors, or parts may be damaged.

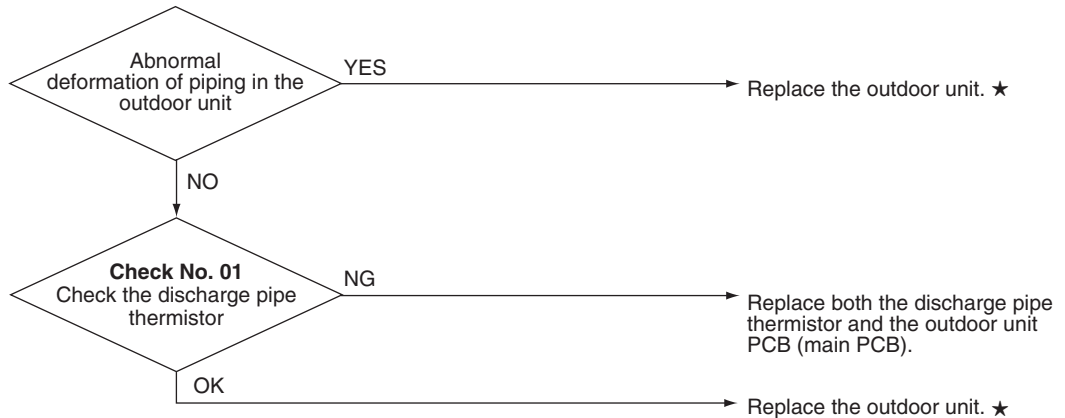

★ Replace the unit as directed in the installation manual, making sure that air does not intrude into the refrigerant piping.

(R23655)



Reference

Check No.01 Refer to P.186

7.12 Compressor Sensor System Abnormality

Error Code	H0
Method of Error Detection	The system checks the DC current before the compressor starts.
Error Decision Conditions	<ul style="list-style-type: none"> ■ The voltage converted from the DC current before compressor start-up is out of the range 0.5 ~ 4.5 V. ■ The DC voltage before compressor start-up is below 50 V.
Supposed Causes	<ul style="list-style-type: none"> ■ Broken or disconnected harness ■ Defective outdoor unit PCB

Troubleshooting

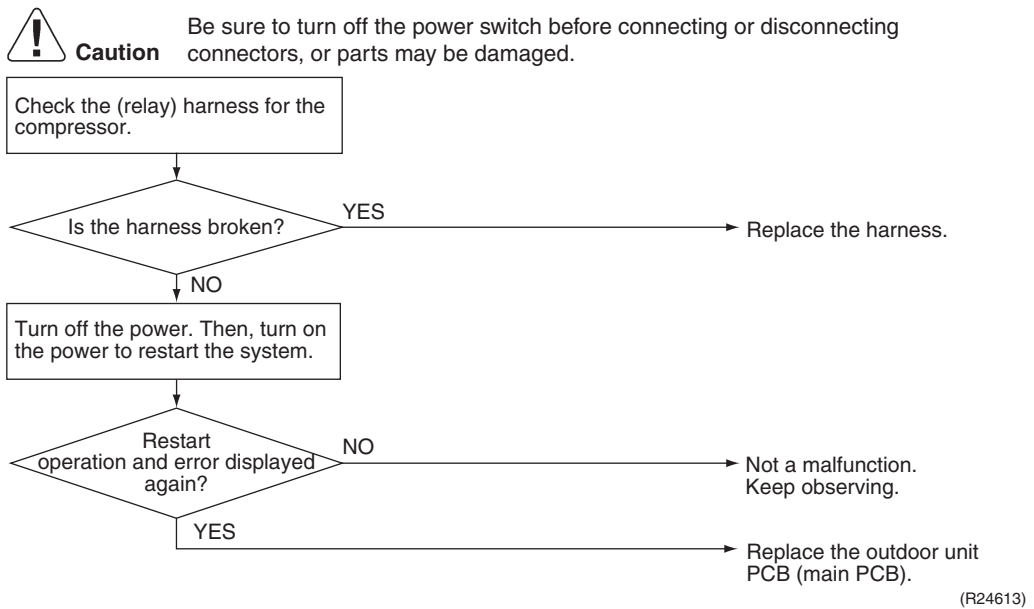

7.13 Position Sensor Abnormality

Error Code**H6**

Method of Error Detection

A compressor start-up failure is detected by checking the compressor running condition through the position detection circuit.

Error Decision Conditions

- If the error repeats, the system is shut down.
 - Reset condition: Continuous run for about 11 minutes without any other error
-

Supposed Causes

- Power supply voltage out of specification
- Disconnection of the compressor harness
- Defective compressor
- Defective outdoor unit PCB
- Start-up failure caused by the closed stop valve
- Input voltage outside the specified range

Troubleshooting



Caution Be sure to turn off the power switch before connecting or disconnecting connectors, or parts may be damaged.

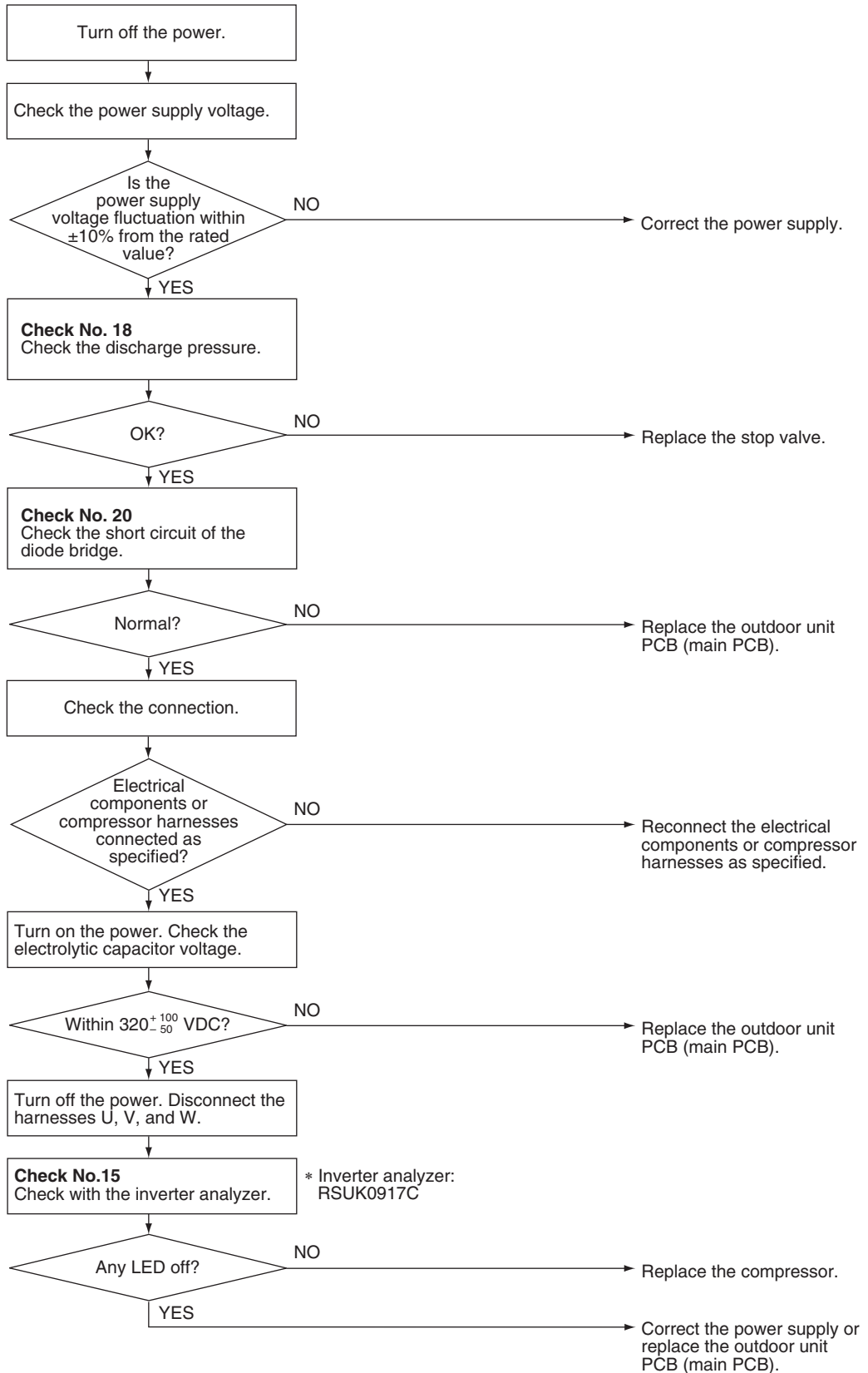

(R22764)

 **Reference** **Check No.15** Refer to P.193

 **Reference** **Check No.18** Refer to P.197

 **Reference** **Check No.20** Refer to P.198

7.14 Thermistor or Related Abnormality (Outdoor Unit)

Error Code	H9, J3, J6, P4
Method of Error Detection	This fault is identified based on the thermistor input voltage to the microcomputer. A thermistor fault is identified based on the temperature sensed by each thermistor.
Error Decision Conditions	<ul style="list-style-type: none"> ■ The voltage between the both ends of the thermistor is either 4.96 V or more, or 0.04 V or less with the power on. ■ J3 error is judged if the discharge pipe temperature is lower than the heat exchanger temperature.
Supposed Causes	<ul style="list-style-type: none"> ■ Disconnection of the connector for the thermistor ■ Defective thermistor(s) ■ Defective heat exchanger thermistor in the case of J3 error (outdoor heat exchanger thermistor in cooling operation, or indoor heat exchanger thermistor in heating operation) ■ Defective outdoor unit PCB
Troubleshooting	<p>In case of P4</p> <div style="display: flex; align-items: center;">  <div style="margin-left: 10px;"> <p>Caution Be sure to turn off the power switch before connecting or disconnecting connectors, or parts may be damaged.</p> </div> </div> <p>Replace the outdoor unit PCB (main PCB).</p> <p>P4 : Radiation fin thermistor</p>

Troubleshooting In case of H9, J3, J6



Caution Be sure to turn off the power switch before connecting or disconnecting connectors, or parts may be damaged.

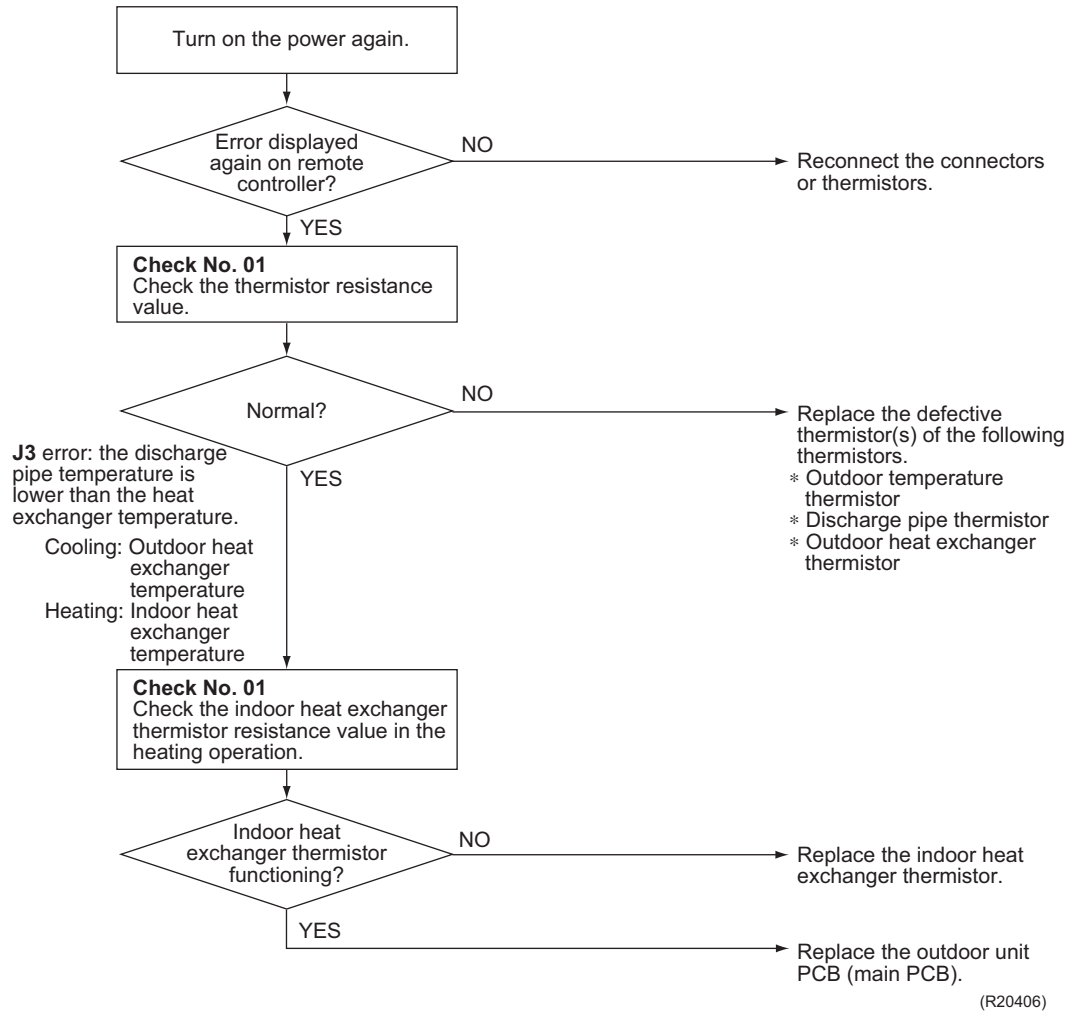

(R20406)

- H9** : Outdoor temperature thermistor
- J3** : Discharge pipe thermistor
- J6** : Outdoor heat exchanger thermistor



Reference

Check No.01 Refer to P.186

7.15 Electrical Box Temperature Rise

Error Code L3

Method of Error Detection An electrical box temperature rise is detected by checking the radiation fin thermistor with the compressor off.

- Error Decision Conditions**
- With the compressor off, the radiation fin temperature is above **A**.
 - The error is cleared when the radiation fin temperature drops below **B**.
 - To cool the electrical components, the outdoor fan starts when the radiation fin temperature rises above **C** and stops when the radiation fin temperature drops below **B**.

	A		B		C	
	°C	°F	°C	°F	°C	°F
09 class	82	179.6	65	149	70	158
12 class	90	194	75	167	81	177.8
15 class	90	194	64	147.2	81	177.8
18/24 class	92	197.6	70	158	77	170.6

- Supposed Causes**
- Defective outdoor fan motor
 - Short circuit
 - Defective radiation fin thermistor
 - Disconnection of connector
 - Defective outdoor unit PCB

Troubleshooting

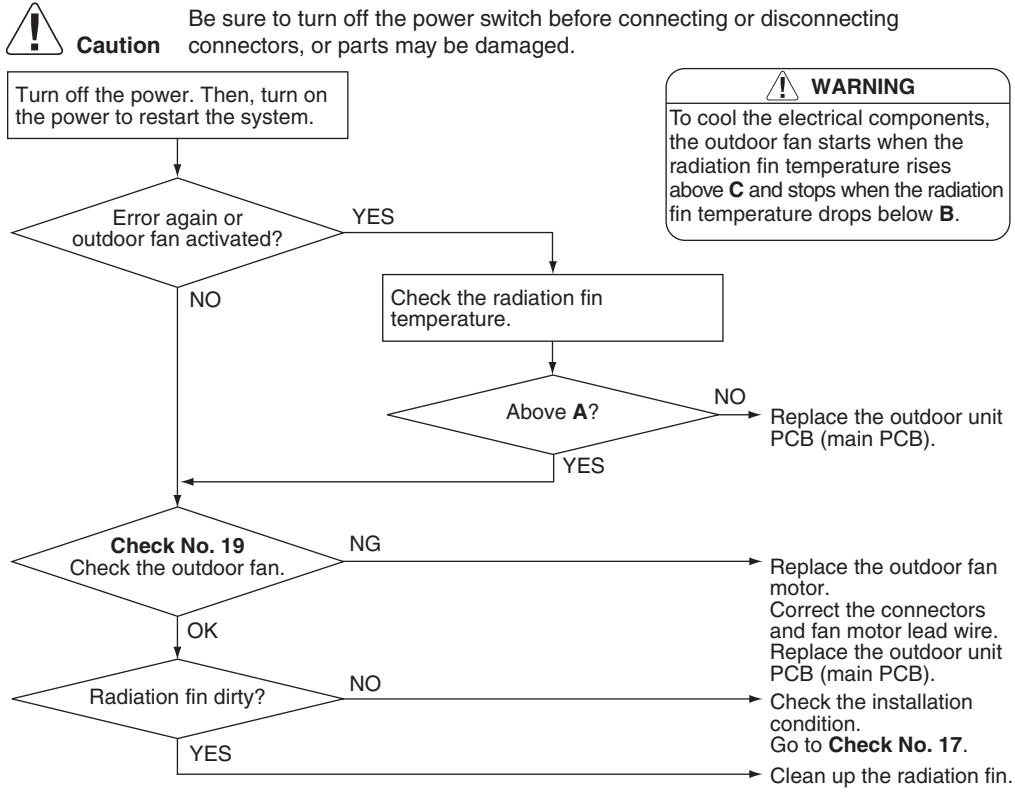

(R22998)

Reference **Check No.17** Refer to P.197



Reference

Check No.19 Refer to P.198

7.16 Radiation Fin Temperature Rise

Error Code	L4			
Method of Error Detection	A radiation fin temperature rise is detected by checking the radiation fin thermistor with the compressor on.			
Error Decision Conditions	<ul style="list-style-type: none"> ■ If the radiation fin temperature with the compressor on is above A. ■ The error is cleared when the radiation fin temperature drops below B. ■ If the error repeats, the system is shut down. ■ Reset condition: Continuous run for about 60 minutes without any other error 			
	A		B	
	°C	°F	°C	°F
09 class	99	210.2	70	158
12 class	90	194	84	183.2
15 class	100	212	57	134.6
18/24 class	82	179.6	77	170.6
Supposed Causes	<ul style="list-style-type: none"> ■ Defective outdoor fan motor ■ Short circuit ■ Defective radiation fin thermistor ■ Disconnection of connector ■ Defective outdoor unit PCB ■ Silicone grease not applied properly on the radiation fin after replacing the outdoor unit PCB 			

Troubleshooting

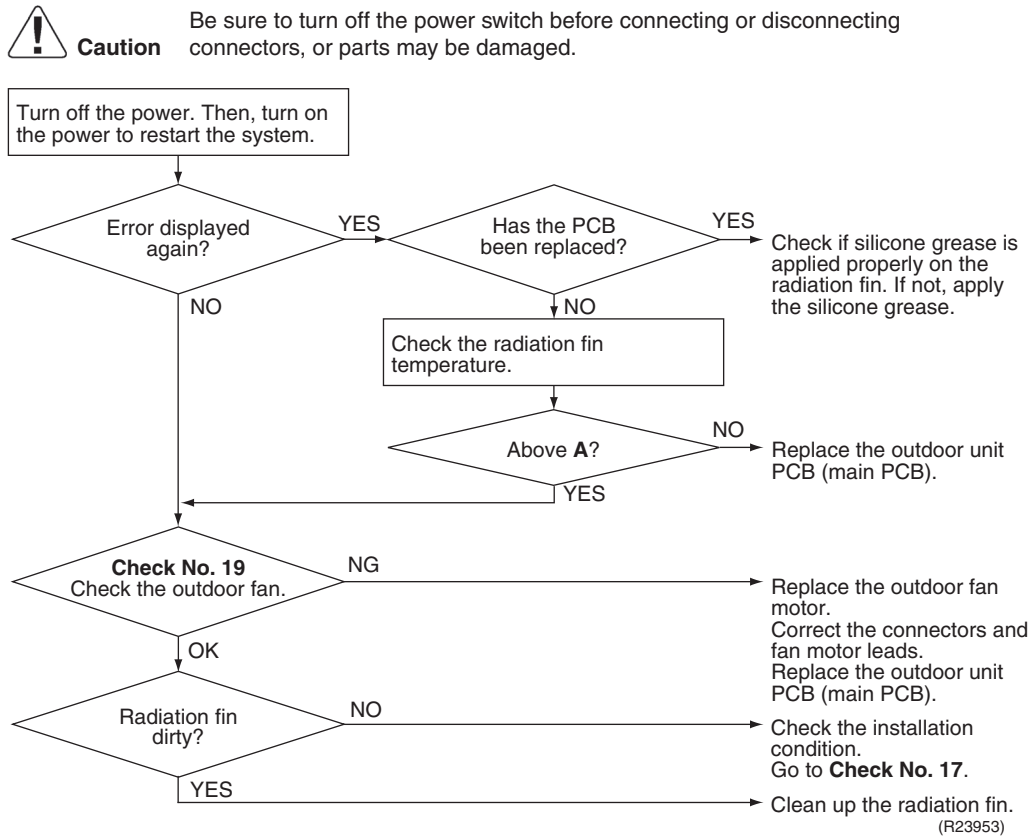

 **Reference** **Check No.17** Refer to P.197

 **Reference** **Check No.19** Refer to P.198

 **Note** Refer to Silicone Grease on Power Transistor/Diode Bridge on page 233 for details.

7.17 Output Overcurrent Detection

Error Code	L5
Method of Error Detection	An output overcurrent is detected by checking the current that flows in the inverter DC section.
Error Decision Conditions	<ul style="list-style-type: none"> ■ A position signal error occurs while the compressor is running. ■ A rotation speed error occurs while the compressor is running. ■ An output overcurrent signal is fed from the output overcurrent detection circuit to the microcomputer. ■ If the error repeats, the system is shut down. ■ Reset condition: Continuous run for about 11 minutes without any other error
Supposed Causes	<ul style="list-style-type: none"> ■ Poor installation condition ■ Closed stop valve ■ Defective power module ■ Wrong internal wiring ■ Abnormal power supply voltage ■ Defective outdoor unit PCB ■ Power supply voltage out of specification ■ Defective compressor

Troubleshooting



Caution Be sure to turn off the power switch before connecting or disconnecting connectors, or parts may be damaged.

* An output overcurrent may result from wrong internal wiring. If the system is interrupted by an output overcurrent after the wires have been disconnected and reconnected for part replacement, check the wiring again.

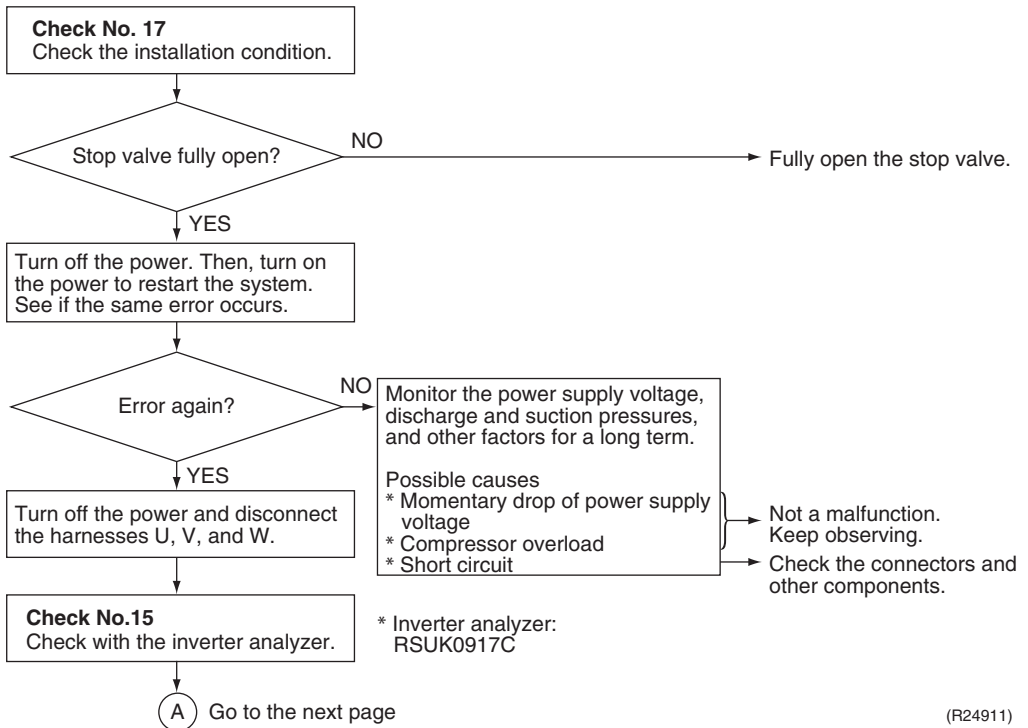

(R24911)

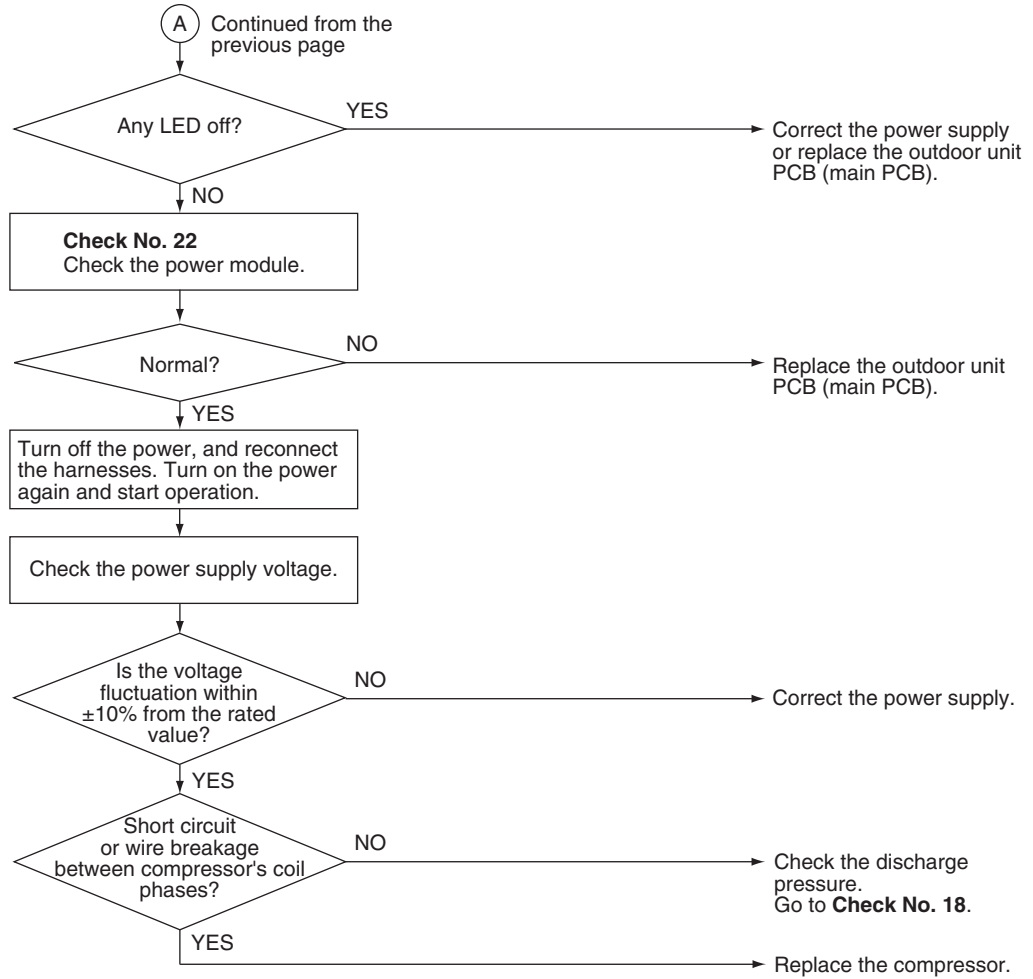

(R24912)



Reference **Check No.15** Refer to P.193



Reference **Check No.17** Refer to P.197



Reference **Check No.18** Refer to P.197



Reference **Check No.22** Refer to P.201

7.18 Signal Transmission Error on Outdoor Unit PCB

Error Code	U7
Method of Error Detection	Communication error between microcomputer mounted on the main PCB and PM1.
Error Decision Conditions	<ul style="list-style-type: none"> ■ The abnormality is determined when the data sent from the PM1 cannot be received for 9 seconds. ■ The error counter is reset when the data from the PM1 can be successfully received.
Supposed Causes	<ul style="list-style-type: none"> ■ Defective outdoor unit PCB

Troubleshooting

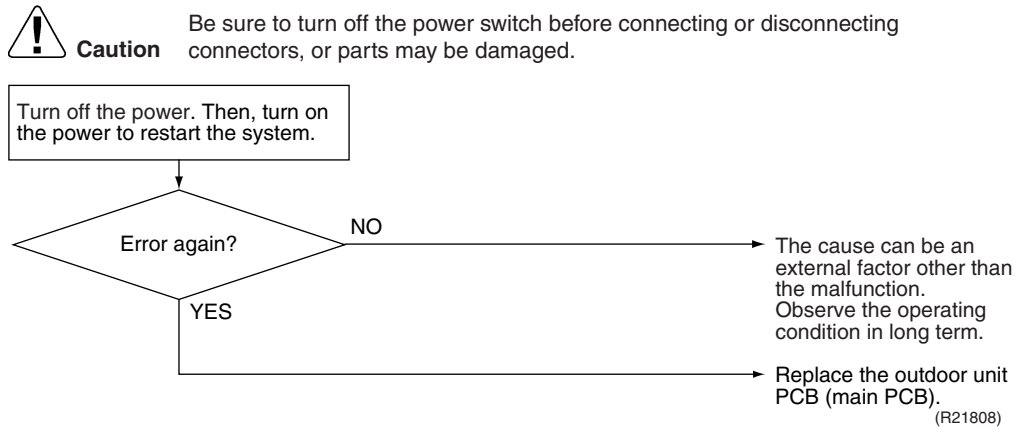

8. Check

8.1 Thermistor Resistance Check

Check No.01

Measure the resistance of each thermistor using multimeter.
 The resistance values are defined by below table.
 If the measured resistance value does not match the listed value, the thermistor must be replaced.

- Disconnect the connector of thermistor ASSY from the PCB to measure the resistance between the pins using multimeter.
- To check the thermistor soldered on a PCB, disconnect the PCB from other PCB/parts, and measure the resistance between the both ends of soldered thermistor.

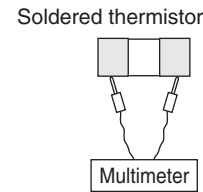
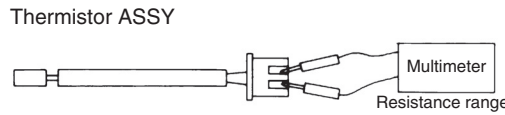

Thermistor temperature		Type A	Type B
°C	°F	R(25°C / 77°F) = 20 kΩ B = 3950 K	R(25°C / 77°F) = 10 kΩ B = 3435 K
-20	-4	197.8	73.4
-15	5	148.2	57.0
-10	14	112.1	44.7
-5	23	85.60	35.3
0	32	65.93	28.2
5	41	51.14	22.6
10	50	39.99	18.3
15	59	31.52	14.8
20	68	25.02	12.1
25	77	20.00	10.0
30	86	16.10	8.2
35	95	13.04	6.9
40	104	10.62	5.8
45	113	8.707	4.9
50	122	7.176	4.1

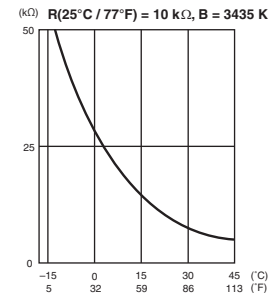
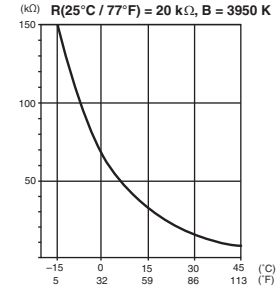

R6000680

Thermistor			FTX09/12/15	FTX18/24 FVXS	FDMQ
Indoor Unit	R1T	Room temperature thermistor	B	A	—
	R2T	Indoor heat exchanger thermistor	A	A	—
	R1T	Suction air thermistor	—	—	A
	R2T	Middle thermistor	—	—	A
	R3T	Liquid pipe thermistor	A	A	A
Outdoor Unit	R1T	Outdoor air temperature thermistor	A	A	A
	R2T	Outdoor heat exchanger thermistor	A	A	A
	R3T	Discharge pipe thermistor	A	A	A



Note(s)

When replacing the defective thermistor(s), replace the thermistor as ASSY.

8.2 Indoor Fan Motor Connector Check

Check No.02

FTX18/24, FVXS

1. Check the connection of connector.
2. Check motor power supply voltage output (pins 4 - 7).
3. Check motor control voltage (pins 4 - 3).
4. Check rotation command voltage output (pins 4 - 2).
5. Check rotation pulse input (pins 4 - 1).

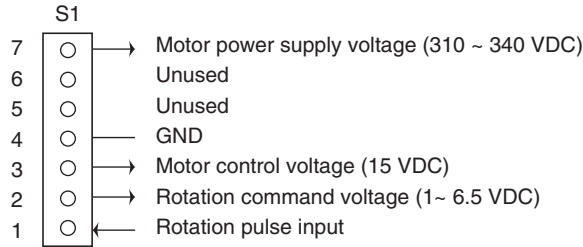

R6000681

FDMQ

1. Turn the power supply OFF.
2. With the fan motor connector disconnected, measure the resistance between each pin, then make sure that the resistance is more than the value mentioned in the following table.

Measuring points	Judgement
White - Blue	1 MΩ or more
Orange - Blue	100 kΩ or more
Brown - Blue	100 Ω or more
Red - Blue	100 kΩ or more

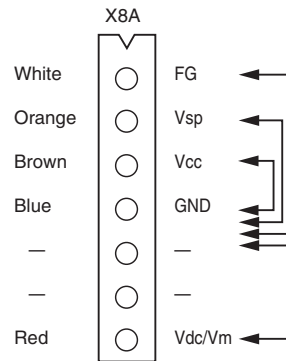

(R25080)

Check No.03

FTX09/12/15

- Fan motor wire breakdown/short circuit check
 - (1) Check the connector for connection.
 - (2) Turn the power off.
 - (3) Check if each resistance at the phases U - V and V - W is within specified range in the table below.

- Motor control voltage check
 - (1) Check the connector for connection.
 - (2) Check the motor control voltage is generated (between the pins 2 - 3).

- Rotation pulse check
 - (1) Check the connector for connection.
 - (2) Turn the power on and stop the operation.
 - (3) Check if the Hall IC generates the rotation pulse 4 times when the fan motor is manually rotated once (between the pins 1 - 3).

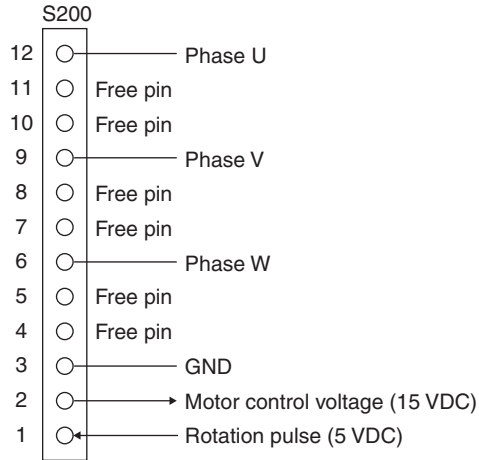

R6000090

	U-V/V-W Resistance (Ω)
FTX09/12	67.0 ~ 85.1
FTX15	39.6 ~ 50.3

i Note

A measurement error might occur in the resistance value depending on the measurement conditions and the method.

8.3 Power Supply Waveform Check

Check No.11

Measure the power supply waveform between No. 1 and No. 2 on the terminal strip, and check the waveform disturbance.

- Check if the power supply waveform is a sine wave (Fig.1).
- Check if there is waveform disturbance near the zero-cross (sections circled in Fig.2).

[Fig.1]

[Fig.2]

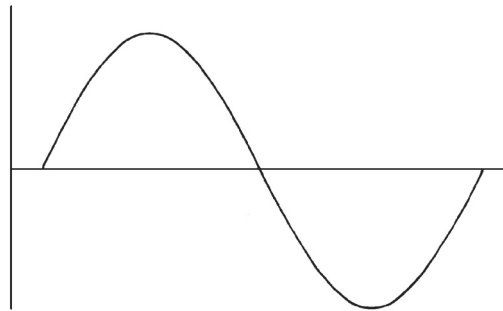

(R1736)

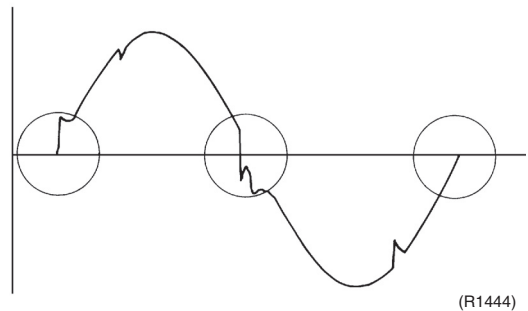

(R1444)

8.4 Electronic Expansion Valve Check

Check No.12

Conduct the following to check the electronic expansion valve (EV).

1. Check if the EV connector is correctly connected to the PCB.
2. Turn the power off and on again, and check if the EV generates a latching sound.
3. If the EV does not generate a latching sound in step 2, disconnect the connector and check the continuity using a multimeter.
4. Check the continuity between the pins 5 - 1, 5 - 2, 5 - 3, 5 - 4 (between the pins 6 - 1, 6 - 2, 6 - 3, and 6 - 4 for the 6P connector models). If there is no continuity between the pins, the EV coil is faulty.
5. If the continuity is confirmed in step 3, the outdoor unit PCB (main PCB) is faulty.

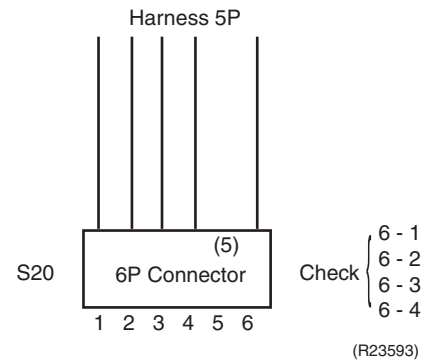
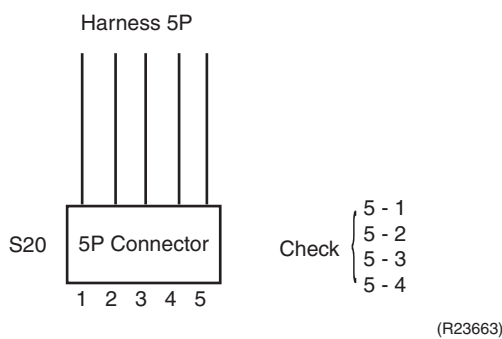

8.5 Four Way Valve Performance Check

Check No.13

09/12 Class

Turn off the power. Then, turn on the power to restart the system.

Start heating operation.

* Four way valve coil
Cooling/Dry/Defrost: Not energized
Heating: energized

S80 voltage at 208 - 230 VAC with compressor on?
(Fig. 1)

NO

Replace the outdoor unit PCB (main PCB).

YES

Disconnect the four way valve coil from the connector and check the continuity.

Four way valve coil resistance at 1000 ~ 2000 Ω?

NO

Replace the four way valve coil.

YES

Replace the four way valve.

(R21936)

(Fig. 1)

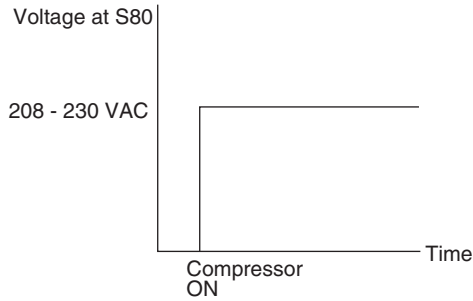

(R14674)

■ 15/18/24 Class

< Caution on resetting the power supply >
 * Be sure to wait for 30 sec. or more after turning off the power.

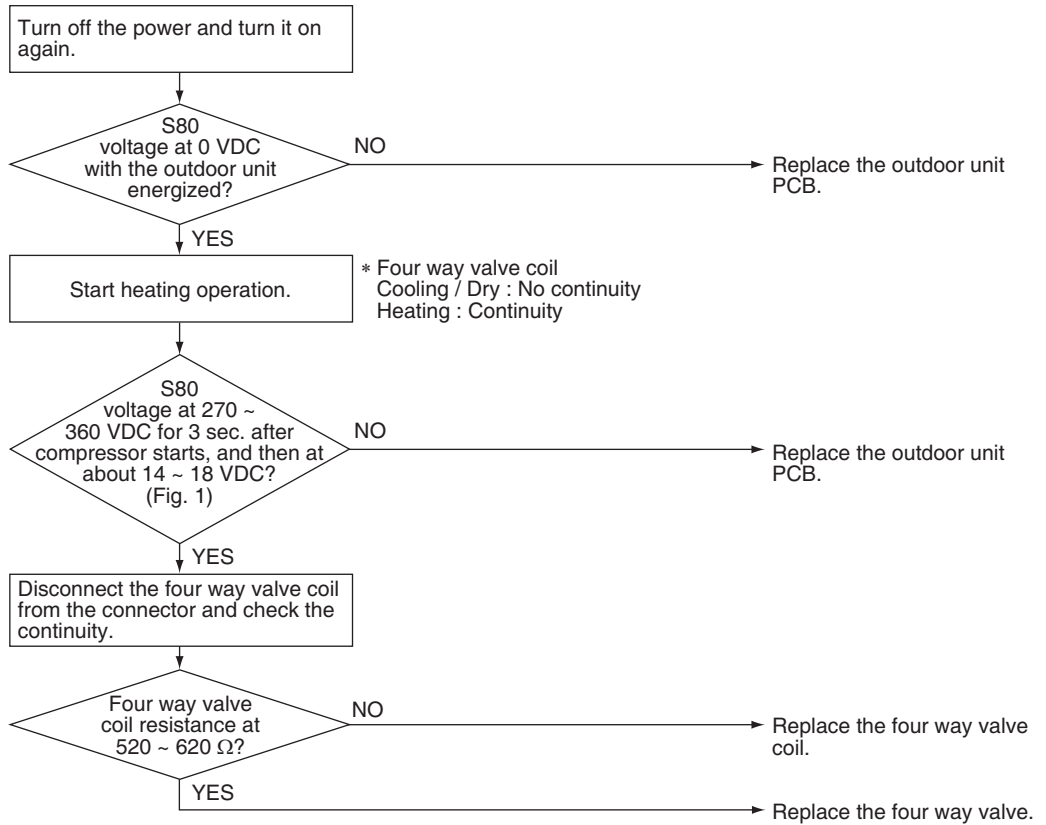

(Fig. 1)

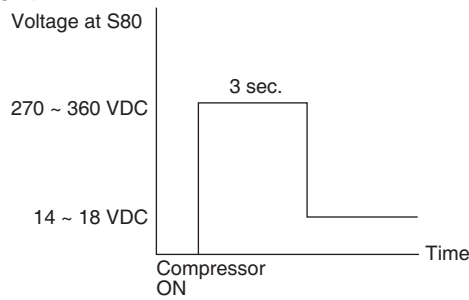

R6000939

8.6 Inverter Unit Refrigerant System Check

Check No.14

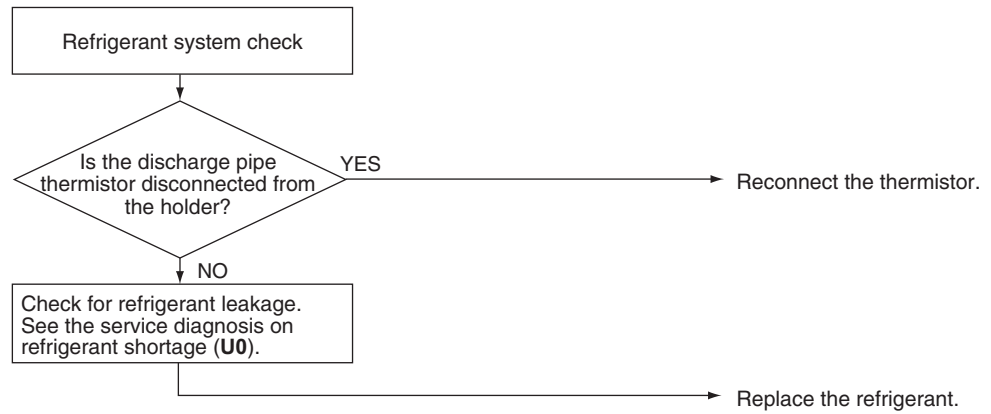

R6000874

8.7 Inverter Analyzer Check

Check No.15

■ Characteristics

Inverter analyzer: RSUK0917C

If an abnormal stop occurs due to compressor startup failure or overcurrent output when using an inverter unit, it is difficult to judge whether the stop is caused by the compressor failure or some other failure (main PCB, power module, etc.). The inverter analyzer makes it possible to judge the cause of trouble easily and securely. Connect an inverter analyzer as a quasi-compressor instead of compressor and check the output of the inverter.

■ Operation Method

Step 1

Be sure to turn the power off.

Step 2

Install an inverter analyzer instead of a compressor.

Note:

Make sure the charged voltage of the built-in smoothing electrolytic capacitor drops to 10 VDC or below before carrying out the service work.

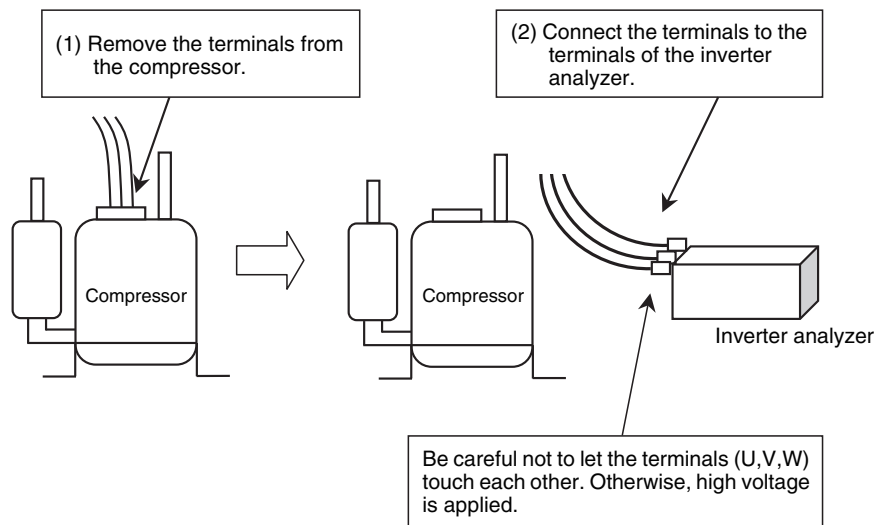

R6000682

Reference:

If the terminals of the compressor are not FASTON terminals (difficult to remove the wire on the terminals), it is possible to connect wires available on site to the outdoor unit from output side of PCB. Do not connect them to the compressor at the same time, otherwise it may result in incorrect detection.

Step 3

Activate the power transistor test operation from the outdoor unit.



Note

Power transistor test operation can be activated only once after turning on the power supply. If reactivation of the power supply transistor operation is needed, turn the power supply off and then on again.

FTX09/12/15

1. Turn the power on.
2. Press the center of **TEMP** button and **OFF** button on the remote controller at the same time.
3. Select **T** with **TEMP**▲ or **TEMP**▼ button.
4. Press **FAN** button.
5. Press **FAN ONLY** button to start the power transistor test operation.

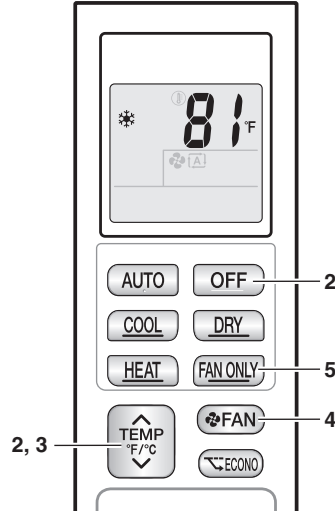

R6000683

FTX18/24, FVXS

1. Turn the power on.
2. Select FAN operation with the **Mode** button on the remote controller.
3. Press the center of the **Temp** button and the **Mode** button at the same time.
4. Select **T** with the **Temp**▲ or **Temp**▼ button.
5. Press the **Mode** button to start the power transistor test operation.

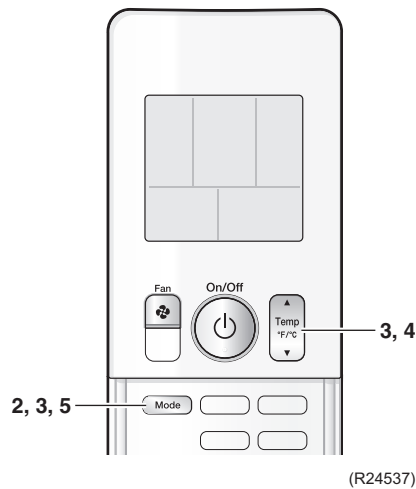



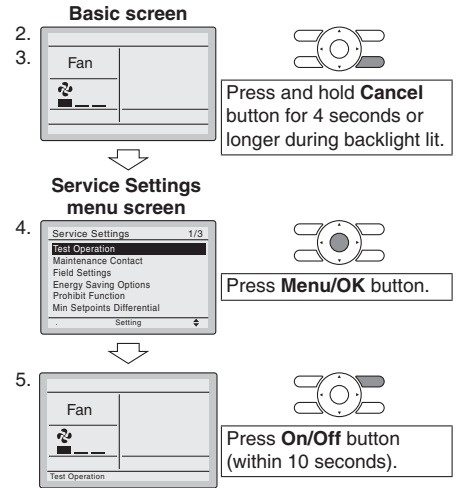

FDMQ with Wired Remote Controller (BRC1E73)

1. Turn the power on.
 2. Set FAN operation using the remote controller.
 3. Press and hold **Cancel** button for 4 seconds or longer.
 4. Select **Test Operation** in the service settings menu, then press **Menu/OK** button.
→ Basic screen returns and “Test Operation” is displayed at the bottom.
 5. Press **On/Off** button within 10 seconds.
→ 3 minutes after pressing **On/Off** button, power transistor test operation will start.
- Test operation will stop automatically after about 30 minutes.
To stop the operation, press **On/Off** button.



FDMQ with Wireless Remote Controller (BRC082A43)

1. Turn the power on.
 2. Press  and select FAN operation.
 3. Press  twice. “TEST” is displayed.
 4. Press  within 10 seconds.
→ 3 minutes after pressing , power transistor test operation will start.
- Test operation will stop automatically after about 30 minutes.
To stop the operation, press .

■ **Diagnose method (Diagnose according to 6 LEDs lighting status.)**

1. If all the LEDs are lit uniformly, the compressor is defective.
→ Replace the compressor.
2. If the LEDs are not lit uniformly, check the power module.
→ Refer to **Check No.22**.
3. If NG in **Check No.22**, replace the power module.
(Replace the main PCB. The power module (IPM1) is united with the main PCB.)
If OK in **Check No.22**, check if there is any solder cracking on the PCB.
4. If any solder cracking is found, replace the PCB or repair the soldered section.
If there is no solder cracking, replace the PCB.



1. When the output frequency is low, the LEDs blink slowly. As the output frequency increases, the LEDs blink quicker. (The LEDs look like they are lit.)
2. On completion of the inverter analyzer diagnosis, be sure to re-crimp the FASTON terminals. Otherwise, the terminals may be burned due to loosening.

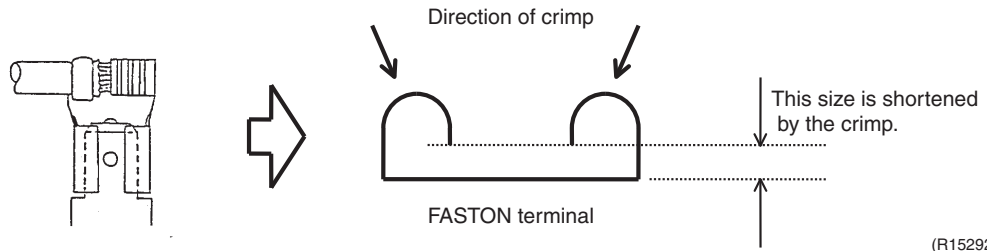

(R15292)

8.8 Outdoor Fan Motor Check

Check No.16

Make sure that the voltage is within 320^{+100}_{-50} VDC.

1. Set operation off and power off. Disconnect the connector S70 or S71.
2. Check that the voltage between the pins 4 - 7 is 320 VDC.
3. Check that the control voltage between the pins 4 - 3 is 15 VDC.
4. Check that the rotation command voltage between the pins 4 - 2 is 0 ~ 6.5 VDC.
5. Keep operation off and power off. Connect the connector S70 or S71.
6. Check whether 4 rotation pulses (0 ~ 15 VDC) are input at the pins 4 - 1 when the fan motor is rotated 1 turn by hand.

When the fuse is melted, check the outdoor fan motor for proper function.

If NG in step 2 → Defective PCB → Replace the outdoor unit PCB (main PCB).

If NG in step 4 → Defective Hall IC → Replace the outdoor fan motor.

If OK in both steps 2 and 4 → Replace the outdoor unit PCB (main PCB).

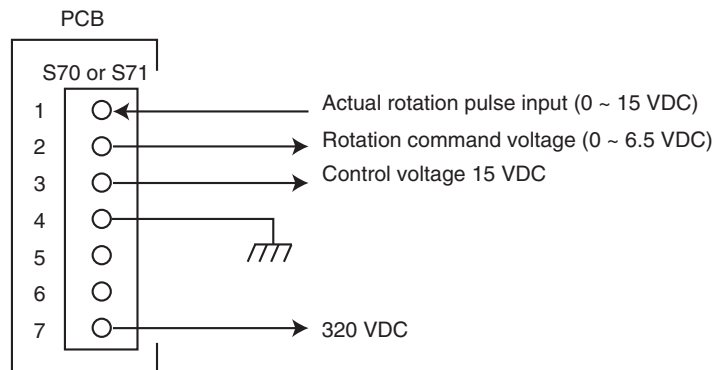

(R20507)

8.9 Installation Condition Check

Check No.17

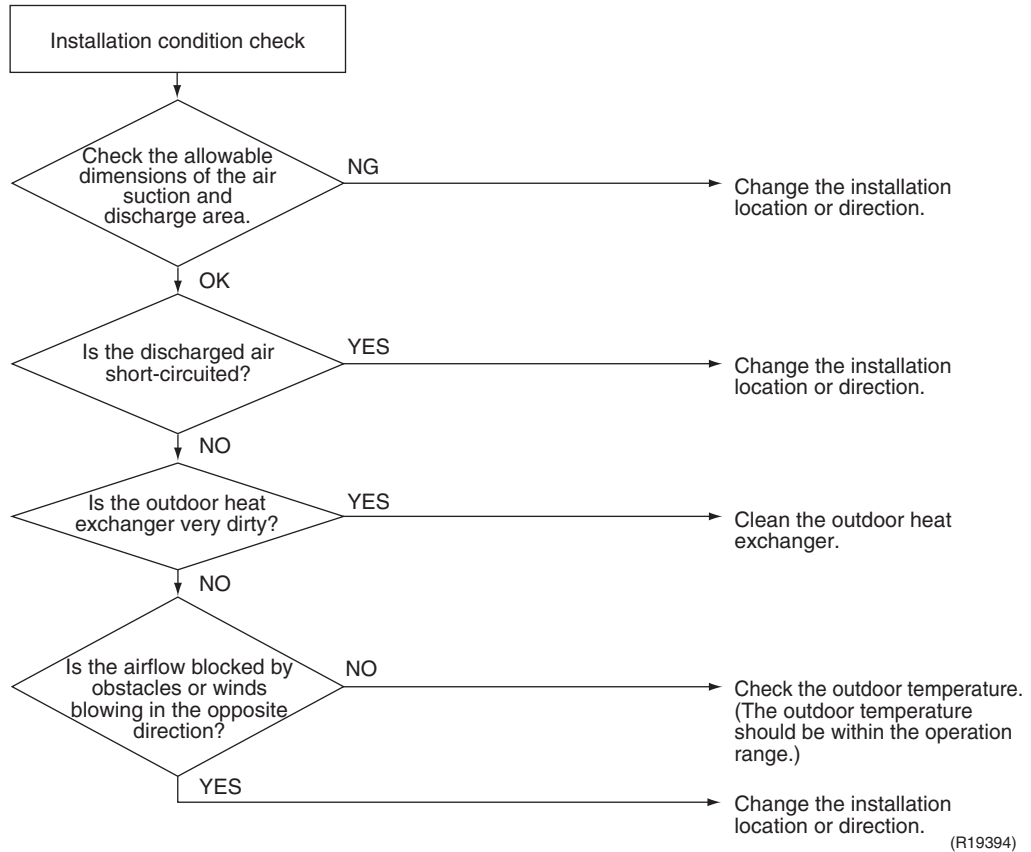

8.10 Discharge Pressure Check

Check No.18

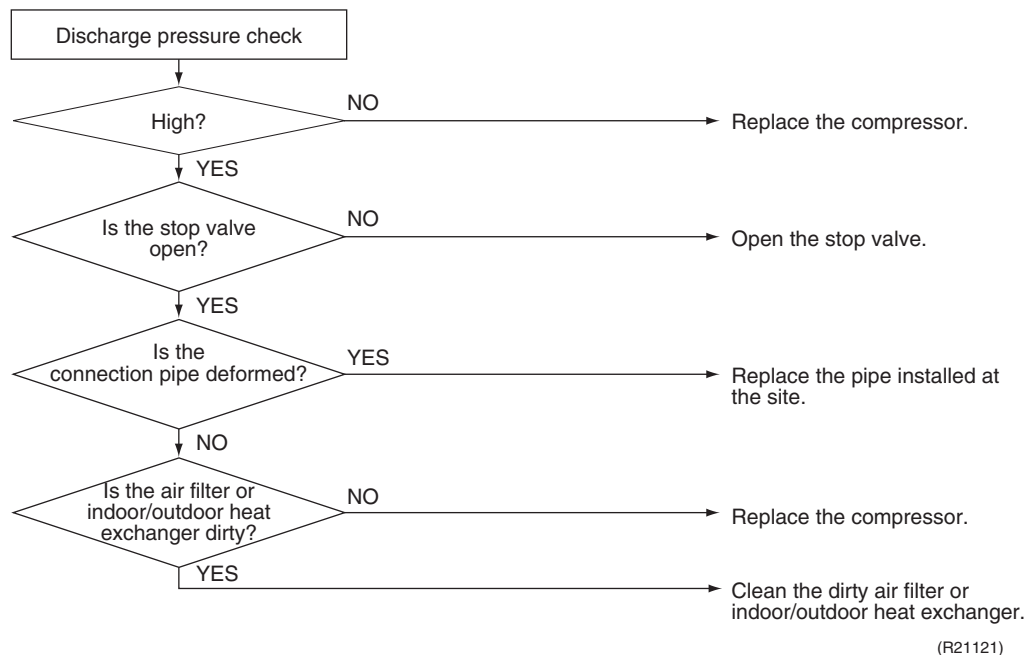

8.11 Outdoor Fan System Check

Check No.19

DC motor

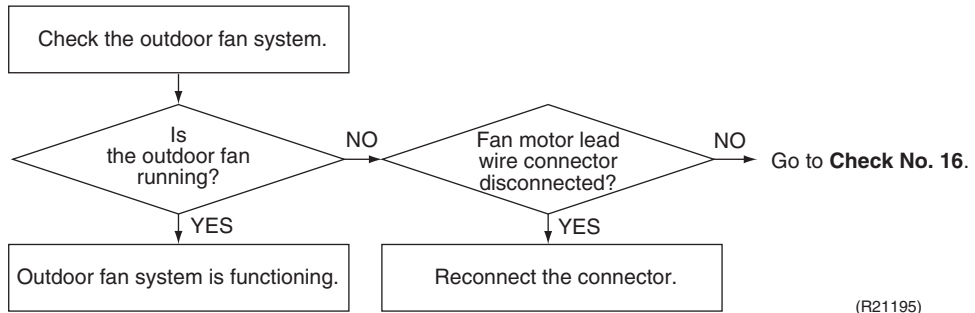

(R21195)

8.12 Main Circuit Short Check

Check No.20

Check to make sure that the voltage between (+) and (-) of the diode bridge (DB1) is about 0 V before checking

- Measure the resistance between the pins of the DB1 referring to the table below.
- If the resistance is ∞ or less than 1 k Ω , short circuit occurs on the main circuit.

Positive terminal (+) of digital multimeter	~ (2, 3)	+ (4)	~ (2, 3)	- (1)
Negative terminal (-) of digital multimeter	+ (4)	~ (2, 3)	- (1)	~ (2, 3)
Resistance is OK.	several k Ω ~ several M Ω			
Resistance is NG.	0 Ω or ∞			

09 class

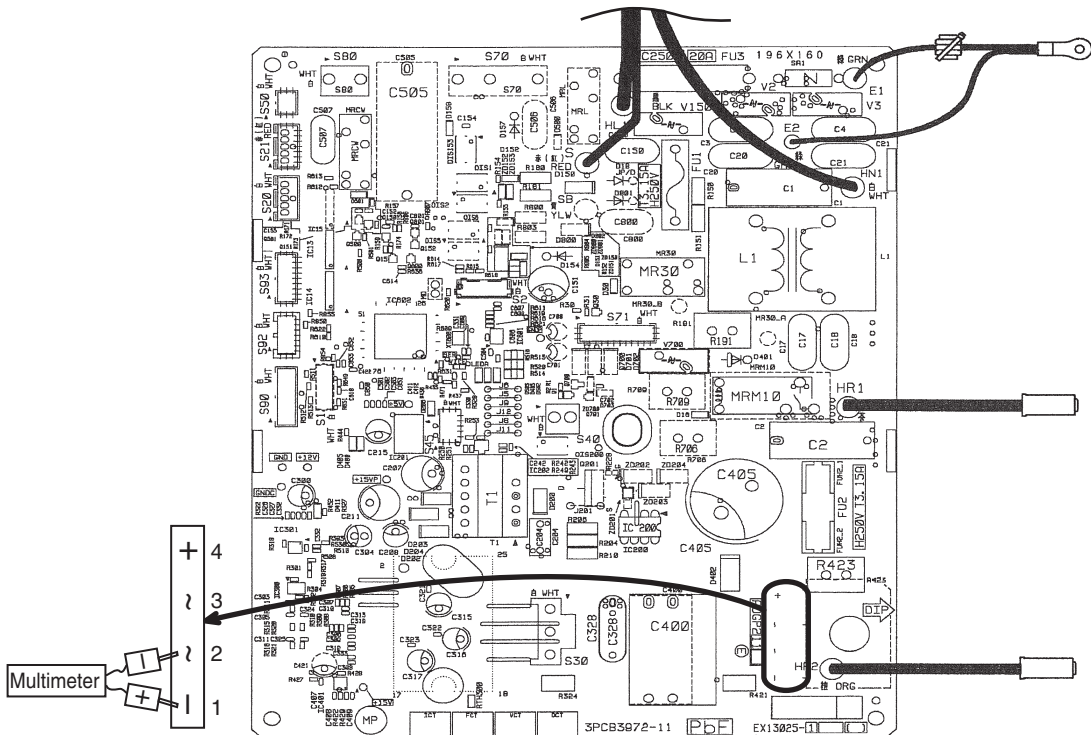

(R20698)

12 class

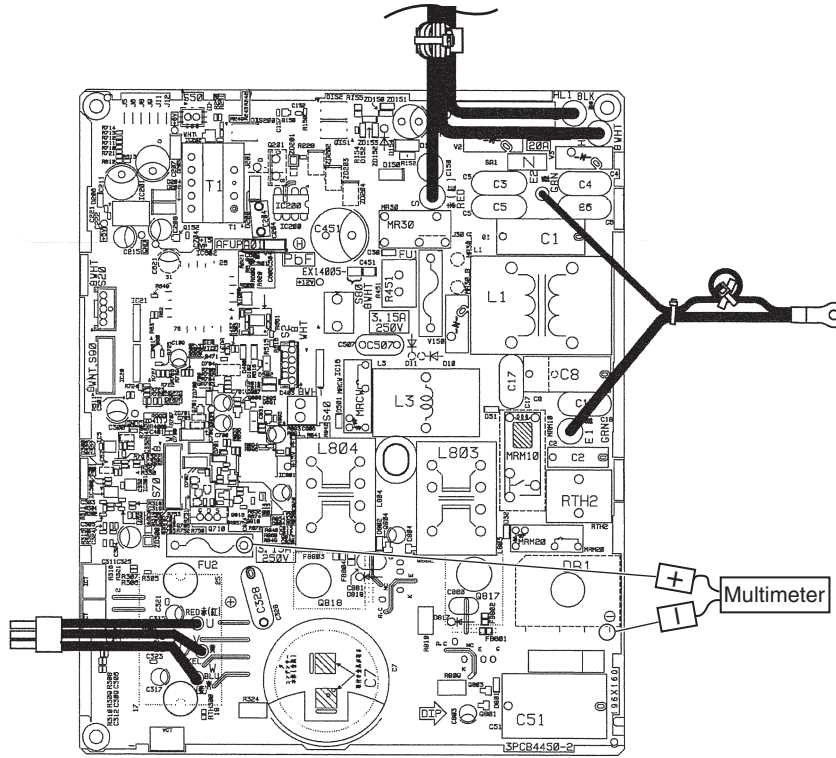

(R23024)

15 class

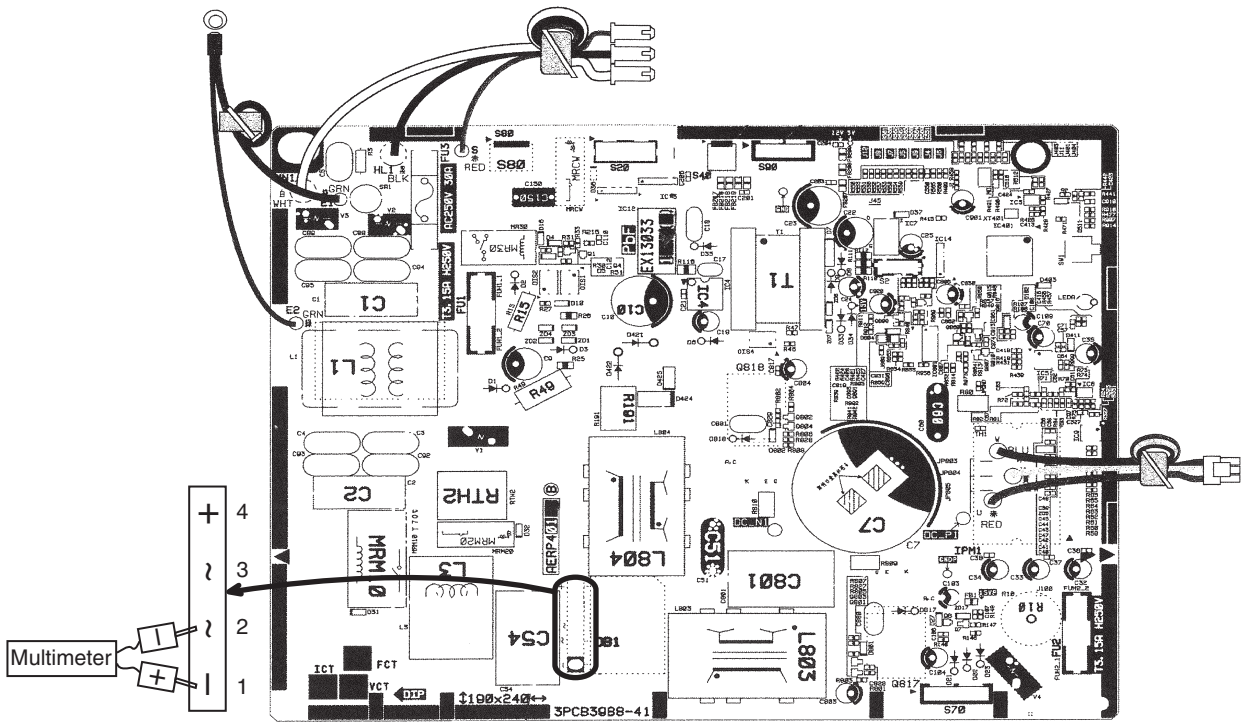

(R25105)

18/24 class

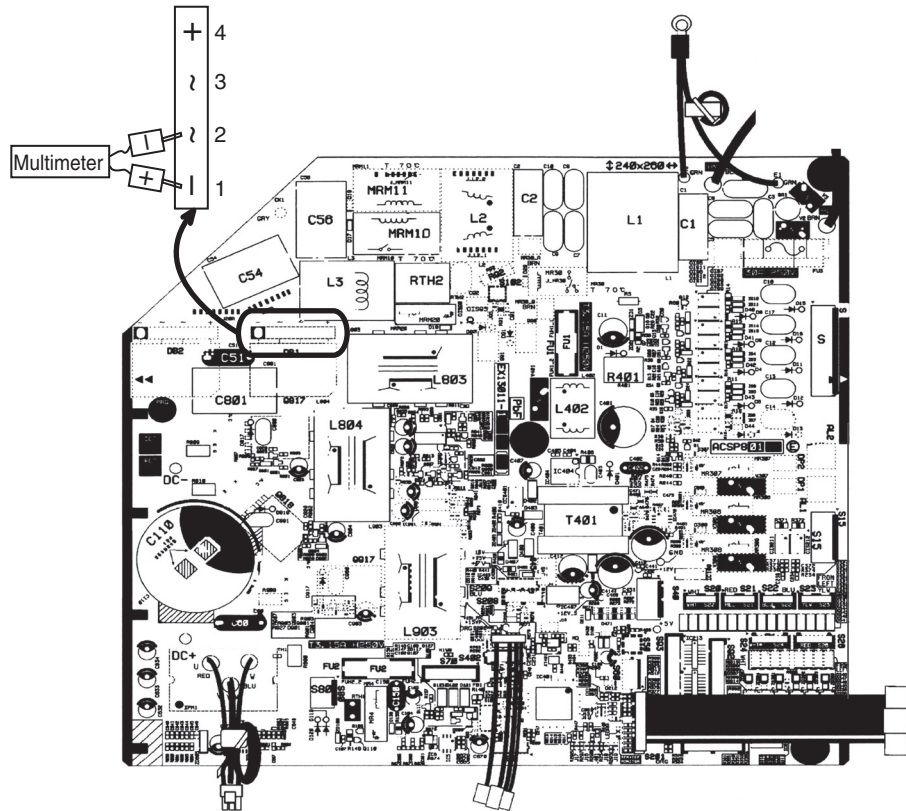

(R24538)

8.13 Power Module Check

Check No.22

Check to make sure that the voltage between (+) and (-) of the power module is about 0 V before checking.

- Disconnect the compressor harness connector from the outdoor unit PCB. To disengage the connector, press the protrusion on the connector.
- Follow the procedure below to measure resistance between the terminals of the power module and the terminals of the compressor with a multimeter. Evaluate the measurement results referring to the following table.

Positive terminal (+) of digital multimeter	Power module (+)	UVW	Power module (-)	UVW
Negative terminal (-) of digital multimeter	UVW	Power module (+)	UVW	Power module (-)
Resistance is OK.	several kΩ ~ several MΩ			
Resistance is NG.	0 Ω or ∞			

09 class

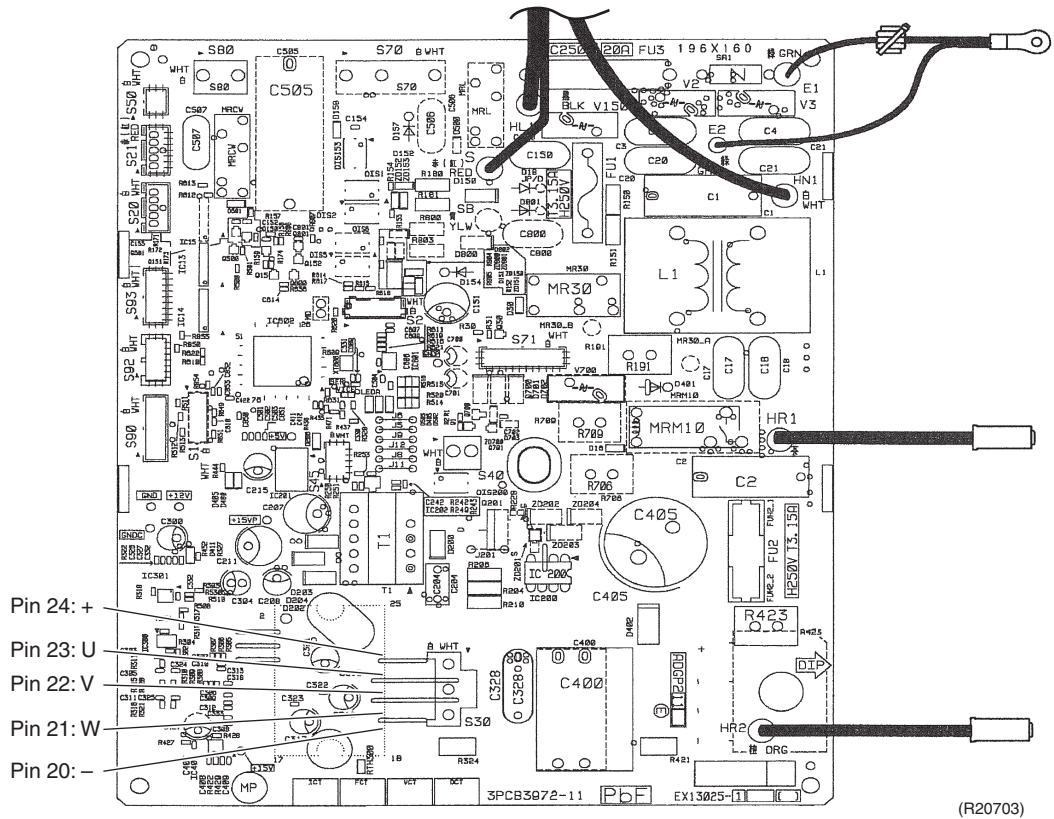

12 class

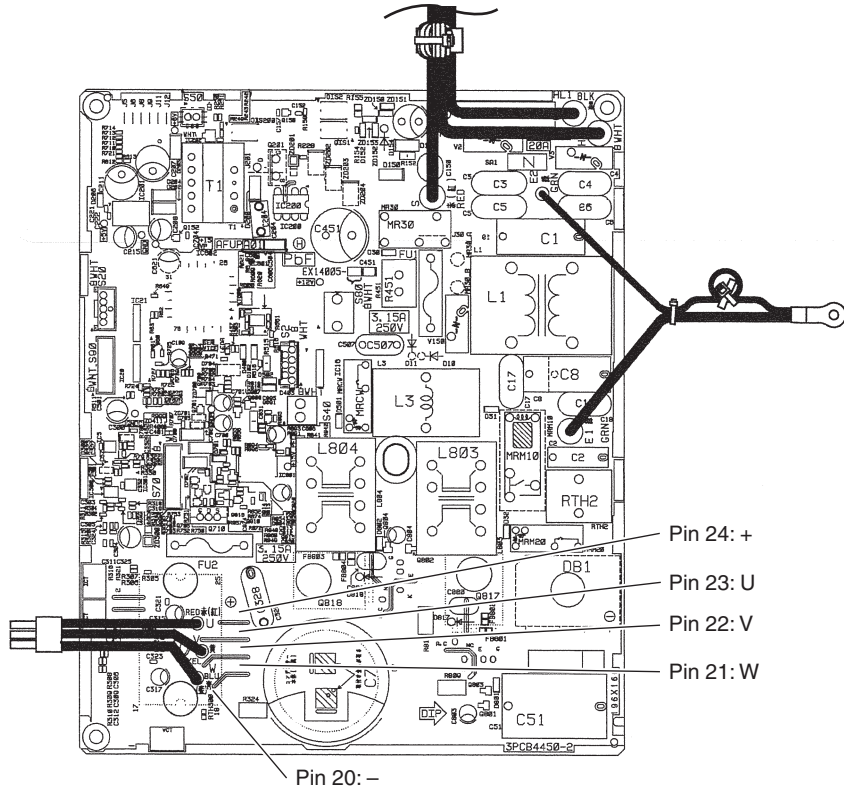

15 class

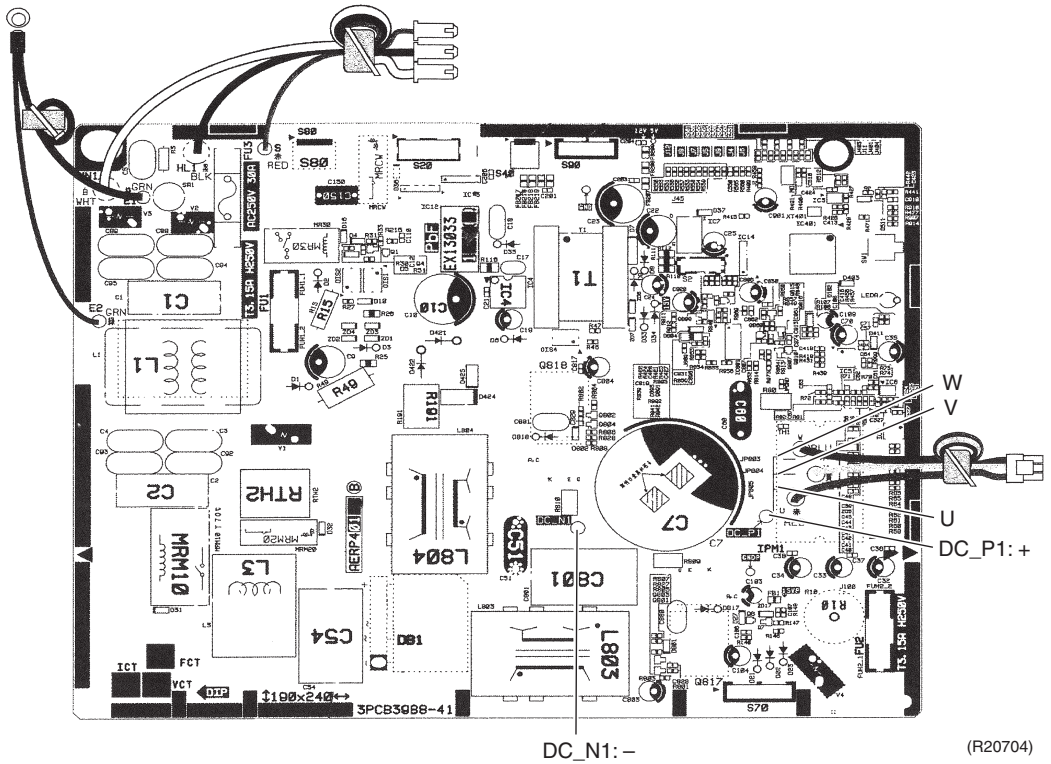

18/24 class

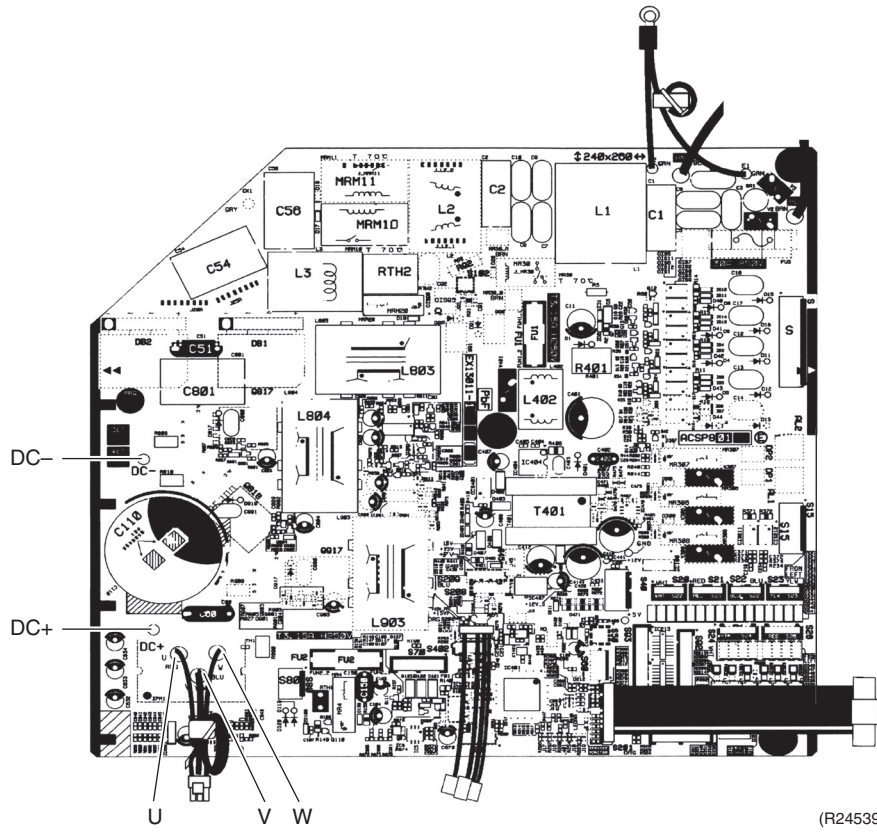

Part 7

Trial Operation and Field Settings

1. Pump Down Operation	205
2. Forced Cooling Operation	206
3. Trial Operation	209
4. Field Settings for FTX, FVXS Series	213
4.1 Temperature Display Switch	213
4.2 When 2 Units are Installed in 1 Room	214
4.3 Jumper and Switch Settings	217
4.4 Service Mode of Wireless Remote Controller	218
5. Field Settings for FDMQ Series	221
5.1 How to Change the Field Settings	221
5.2 Overview of Field Settings	224
5.3 MAIN/SUB and Address Setting for Wireless Remote Controller	225
6. Field Settings for Outdoor Unit	228
6.1 Facility Setting (cooling at low outdoor temperature)	228
6.2 Warmer Airflow Setting	230
6.3 Drain Pan Heater	232
7. Silicone Grease on Power Transistor/Diode Bridge	233

1. Pump Down Operation

Outline

In order to protect the environment, be sure to conduct pump down operation when relocating or disposing of the unit.

Details

1. Remove the valve caps from the liquid stop valve and the gas stop valve.
2. Carry out forced cooling operation.
3. After 5 to 10 minutes, close the liquid stop valve with a hexagonal wrench.
4. After 2 to 3 minutes, close the gas stop valve and stop the forced cooling operation.
5. Attach the valve cap once procedures are complete.

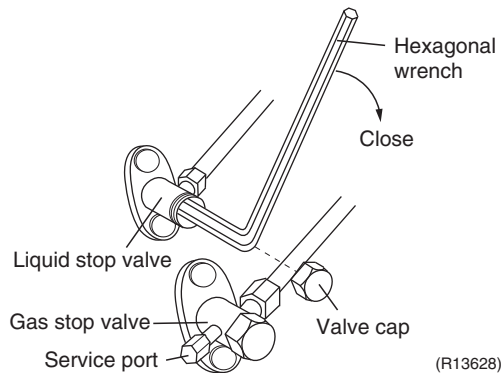

Reference

Refer to Forced Cooling Operation on page 206 for details.

2. Forced Cooling Operation

Outline

The forced cooling operation is allowed when both the following conditions are met.

1. The outdoor unit is not abnormal and not in the 3-minute standby mode.
2. The outdoor unit is not operating.

Protection functions have priority over all other functions during forced cooling operation.

Details

For FTX, FVXS series

■ With indoor unit ON/OFF switch

FTX09/12/15

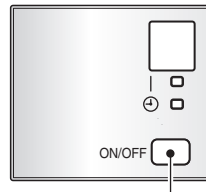

ON/OFF switch (SW1)

R7000271

FTX18/24

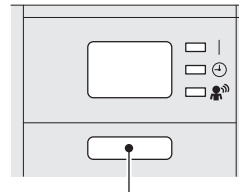

Indoor unit ON/OFF switch

R7000272

FVXS

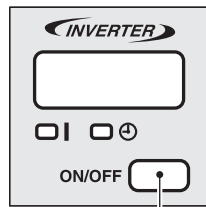

ON/OFF switch (SW1)

R7000273

■ With remote controller

FTX09/12/15

1. Press **Temp▲, ▼** buttons and **OFF** button at the same time.
 2. Press **Temp▲** button, select "T", and press **FAN** button.
 3. Press **COOL** button to turn on the system.
- Forced cooling operation will stop automatically after about 30 minutes.
To stop the operation, press **OFF** button.

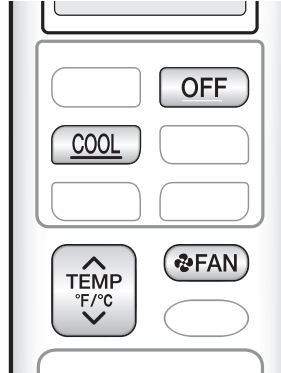

R7000274

FTX18/24, FVXS

1. Press **Temp▲, ▼** buttons and **Mode** button at the same time.
 2. Press **Temp▲** or **▼** buttons, select "T", and press **Mode** button for confirmation.
 3. Press **Mode** button and select the cooling operation.
 4. Press **On/Off** button to turn on the system.
- Forced cooling operation will stop automatically after about 30 minutes.
To stop the operation, press **On/Off** button.

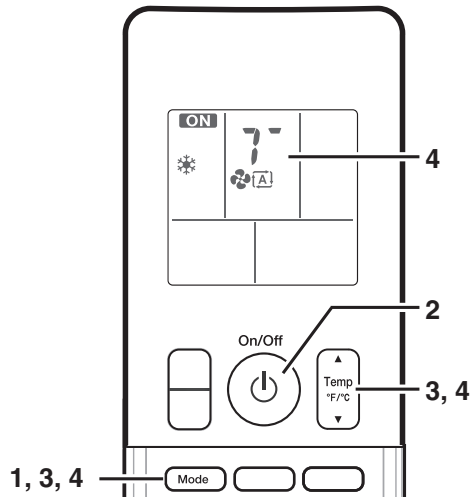

R7000227



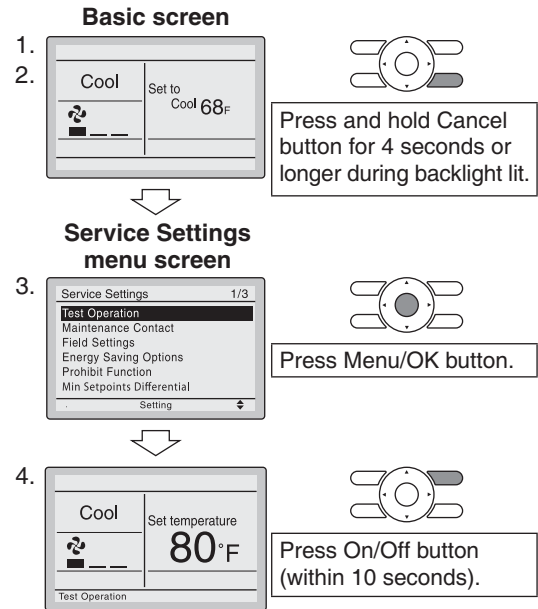

For FDMQ series

■ FDMQ with Wired Remote Controller (BRC1E73)

1. Set to COOL operation using the remote controller.
2. Press and hold **Cancel** button for 4 seconds or longer. Service settings menu is displayed.
3. Select **Test Operation** in the service settings menu, and press **Menu/OK** button. Basic screen returns and “Test Operation” is displayed at the bottom.
4. Press **On/Off** button within 10 seconds, and the forced cooling operation starts.
 - ◆ Forced cooling operation will stop automatically after about 15 minutes. To stop the operation, press **On/Off** button.



■ FDMQ with Wireless Remote Controller (BRC082A43)

1. Press  button and select the COOL operation.
2. Press  button twice. “TEST” is displayed.
3. Press  button within 10 seconds, and the forced cooling operation starts.
 - ◆ Forced cooling operation will stop automatically after about 15 minutes. To stop the operation, press  button.

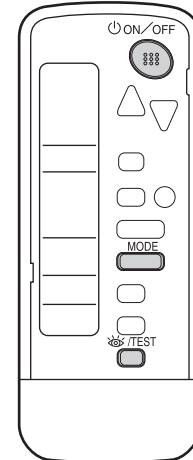

R7000276

3. Trial Operation

Outline

Carry out the trial operation in accordance with the operation manual to ensure that all functions and parts, such as flap movement, are working properly.

Trial operation should be carried out in either cooling or heating operation.

Procedure

1. Measure the power supply voltage and make sure that it falls within the specified range.
2. In cooling operation, select the lowest programmable temperature (18°C (64°F));
in heating operation, select the highest programmable temperature (30°C (86°F)).
 - Trial operation may be disabled in either operation mode depending on the room temperature.
 - After trial operation is complete, set the temperature to a normal level (26 ~ 28°C (78 ~ 82°F) in cooling, 20 ~ 24°C (68 ~ 75°F) in heating).
 - For protection, the system does not start for 3 minutes after it is turned off.

■ ARC480 Series

1. Press the center of **TEMP** button and **OFF** button on the remote controller at the same time.
2. Select **T** (trial operation) with **Temp** \wedge , or \vee button.
3. Press **FAN** button to enter the trial operation mode.
4. Press **COOL** or **HEAT** button to start trial operation.
5. Trial operation terminates in about 30 minutes and switches into normal mode.
To quit trial operation, press **OFF** button.

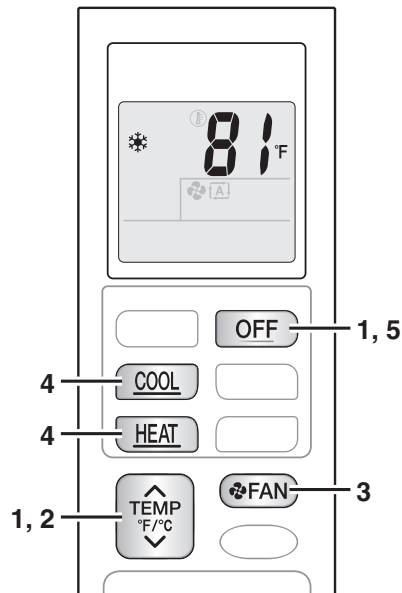

R7000277

■ ARC466 Series

1. Press **Temp ▲, ▼** button and **Mode** button at the same time.
2. Press **Temp ▲** or **▼** button, select "T", and press **Mode** button for confirmation.
3. Press **Mode** button and select operation mode.
4. Press **On/Off** button to turn on the system.
5. Trial operation terminates in about 30 minutes and switches into normal mode.
To quit trial operation, press **On/Off** button.

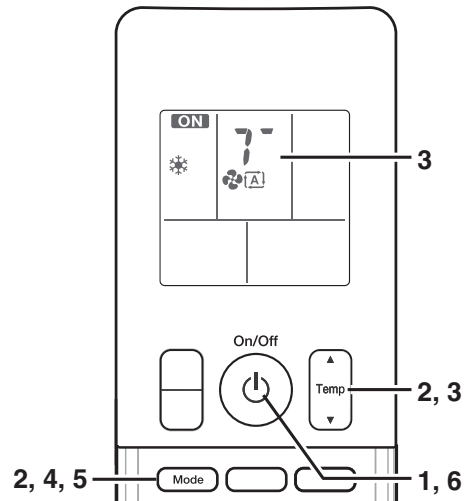

R7000147

■ **Wired Remote Controller (BRC1E73)**

1. Set to COOL or HEAT operation using the remote controller.
2. Press and hold **Cancel** button for 4 seconds or longer. Service settings menu is displayed.
3. Select **Test Operation** in the service settings menu, and press **Menu/OK** button. Basic screen returns and “Test Operation” is displayed at the bottom.
4. Press **On/Off** button within 10 seconds, and the test operation starts.
Monitor the operation of the indoor unit for a minimum of 10 minutes. During test operation, the indoor unit will continue to cool/heat regardless of the temperature setpoint and room temperature.
 - ◆ In the case of above-mentioned procedures 3 and 4 in reverse order, test operation can start as well.
5. Press and hold **Cancel** button for 4 seconds or longer in the basic screen. Service settings menu is displayed.
6. Select **Test Operation** in the service settings menu, and press **Menu/OK** button. Basic screen returns and normal operation is conducted.
 - ◆ Test operation will stop automatically after 15 ~ 30 minutes. To stop the operation, press **On/Off** button.

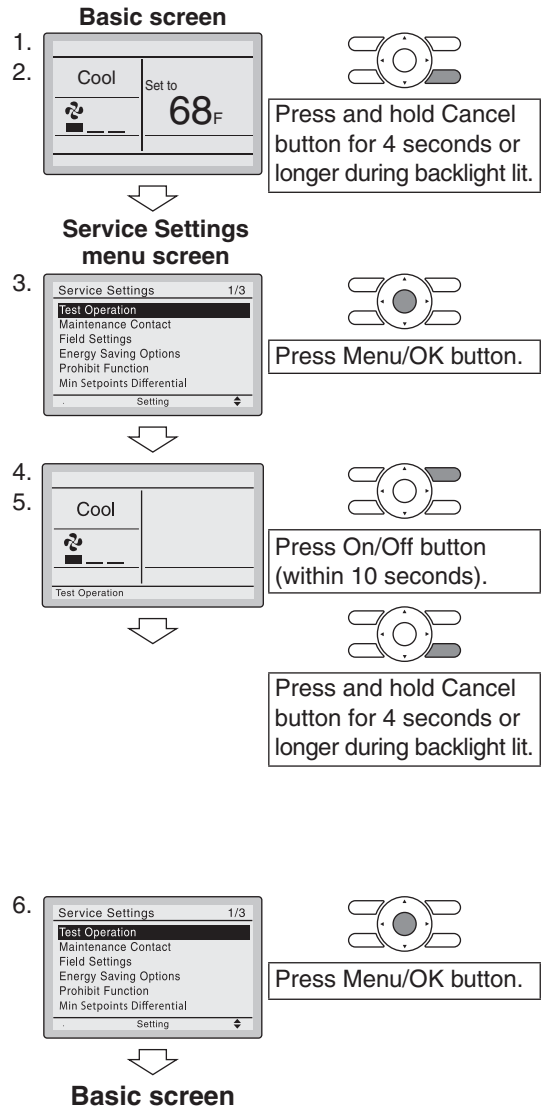

■ **Wireless Remote Controller (BRC082A43)**

1. Press button and select the COOL or HEAT operation.
2. Press button twice. “TEST” is displayed.
3. Press button within 10 seconds, and the test operation starts.
Monitor the operation of the indoor unit for a minimum of 10 minutes. During test operation, the indoor unit will continue to cool/heat regardless of the temperature setpoint and room temperature.
 - ◆ In the case of above-mentioned procedures (1) and (2) in reverse order, test operation can start as well.
 - ◆ Test operation will stop automatically after 15 ~ 30 minutes.
To stop the operation, press button.
 - ◆ Some of the functions cannot be used in the test operation mode.

Test Items

Test items	Symptoms
Indoor and outdoor units are installed securely.	Fall, vibration, noise
Is the outdoor unit fully installed?	No operation or burn damage
No refrigerant gas leaks.	Incomplete cooling/heating function
Refrigerant gas and liquid pipes and indoor drain hose extension are thermally insulated.	Water leakage
Draining line is properly installed.	Water leakage
Does the power supply voltage correspond to that shown on the name plate?	No operation or burn damage
Only specified wires are used for all wiring, and all wires are connected correctly.	No operation or burn damage
System is properly grounded.	Electrical leakage
Is wiring size according to specifications?	No operation or burn damage
Is something blocking the air outlet or inlet of either the indoor or outdoor units?	Incomplete cooling/heating function
Are refrigerant piping length and additional refrigerant charge noted down?	The refrigerant charge in the system is not clear
Pipes and wires are connected to the corresponding connection ports/terminal blocks for the connected unit.	No cooling/heating
Stop valves are opened.	Incomplete cooling/heating function
Check that the connector of the lead wires of the decoration panel is connected securely.	Louvers do not move
Indoor unit properly receives wireless remote control commands.	No operation

4. Field Settings for FTX, FVXS Series

4.1 Temperature Display Switch

ARC480 Series

- You can select Fahrenheit or Celsius for temperature display.
- Press **TEMP**^ button and **ON TIMER** buttons simultaneously for 5 seconds to change the unit of temperature display.
- You can also change the unit of temperature display by pressing **Temp**^ and ∨ buttons simultaneously for 5 seconds.

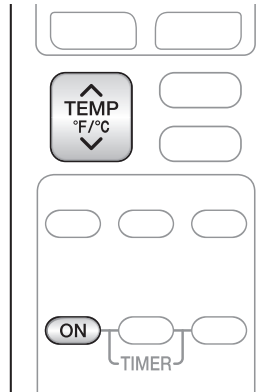

(R14477)

ARC466 Series

- Press the upper side of **Temp** button and **On** button at the same time for 5 seconds to change the unit of temperature display.

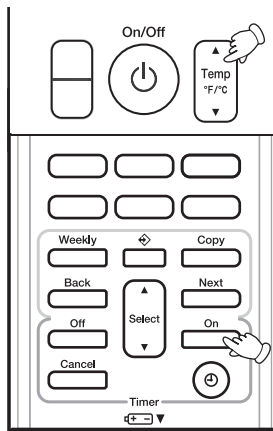

(R22009)

4.2 When 2 Units are Installed in 1 Room

Outline

When 2 indoor units are installed in 1 room, 1 of the 2 indoor units and the corresponding wireless remote controller can be set for different address.

FTX09/12/15

1. Remove the battery cover of the remote controller.
2. Cut the address jumper.
3. Press the center of **TEMP** button and **OFF** switch on the remote controller at the same time.
4. Select **A** (address setting) with **TEMP** \wedge or **TEMP** \vee button.
5. Press **FAN** button to enter the address setting mode.
The indoor unit operation lamp blinks for 1 minute.
6. Press indoor unit **ON/OFF** switch while the operation lamp is blinking.
7. Press **FAN** button on the remote controller for 5 seconds to return to the normal mode.

Wireless Remote Controller

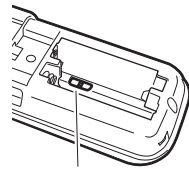

Jumper

Jumper	Address
EXIST	1
CUT	2

R7000281

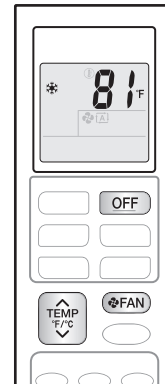

R7000282

Indoor Unit

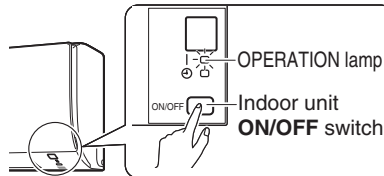

R7000283



Caution

Replace the remote controller if you cut a jumper unintentionally.

Jumpers are necessary for electronic circuit. Improper operation may occur if you cut any of them.

FTX18/24

1. Remove the front grille.
2. Remove the electrical box.
3. Remove the shield plate of the electrical box.
4. Cut the address setting jumper JA on the PCB.
5. Remove the cover of remote controller battery.
6. Cut the address setting jumper J4.

Indoor unit PCB

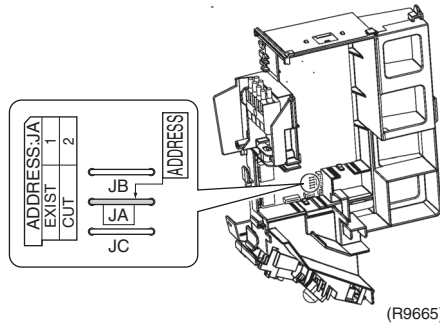

Wireless Remote Controller

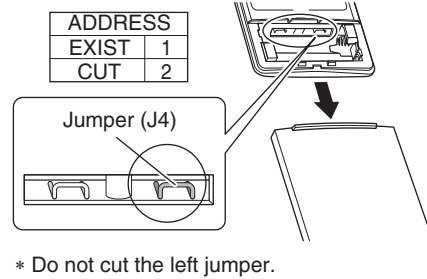

Caution

Replace the PCB if you cut a jumper unintentionally.

Jumpers are necessary for electronic circuit. Improper operation may occur if you cut any of them.



Caution

Replace the remote controller if you cut a jumper unintentionally.

Jumpers are necessary for electronic circuit. Improper operation may occur if you cut any of them.

FVXS

1. Remove the front grille.
2. Lift the sensor PCB fixing plate and remove the front shield plate.
3. Disconnect the connectors S1, S41, S42.
4. Remove the electric box (1 screw).
5. Pull out the indoor heat exchanger thermistor.
6. Remove the shield plate (8 tabs).
7. Cut the address setting jumper JA on the indoor unit PCB.

Indoor Unit PCB

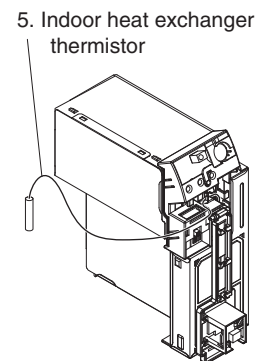
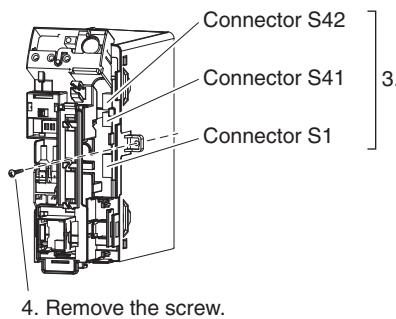

R7000179

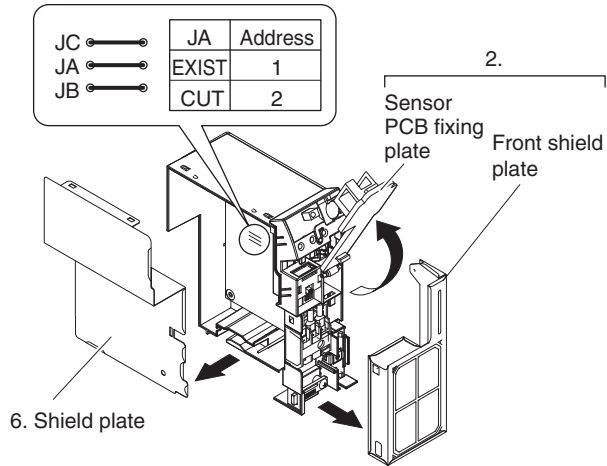

R7000157

Wireless Remote Controller

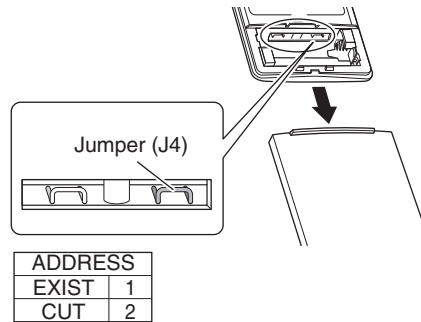

* Do not cut the left jumper.

(R18416)



Caution

Replace the PCB if you cut a jumper unintentionally.

Jumpers are necessary for electronic circuit. Improper operation may occur if you cut any of them.



Caution

Replace the remote controller if you cut a jumper unintentionally.

Jumpers are necessary for electronic circuit. Improper operation may occur if you cut any of them.

4.3 Jumper and Switch Settings

Jumper for FTX18/24, FVXS

Jumper on indoor unit PCB	Function	When connected (factory setting)	When cut
JB	Fan speed setting when compressor stops for thermostat OFF. (effective only at cooling operation)	Fan speed setting; Remote controller setting	The fan stops.
JC	Power failure recovery function	Auto-restart	The unit does not resume operation after recovering from a power failure. Timer settings are cleared.

Switch for FVXS

Switch on indoor unit PCB	Function	OFF (factory setting)	ON
S2W(4) (SW2-4)	Upward airflow limit setting	Exposed or half embedded installation	Set the switch to ON position when you install the indoor unit embedded in the wall to avoid condensation.



Reference

For the location of the jumper and the switch, refer to the following pages.

FTX18/24: page 25

FVXS: page 27

4.4 Service Mode of Wireless Remote Controller

The remote controller mode is hierarchized by special conditions and operation content. Refer below for the main hierarchy of the menu.

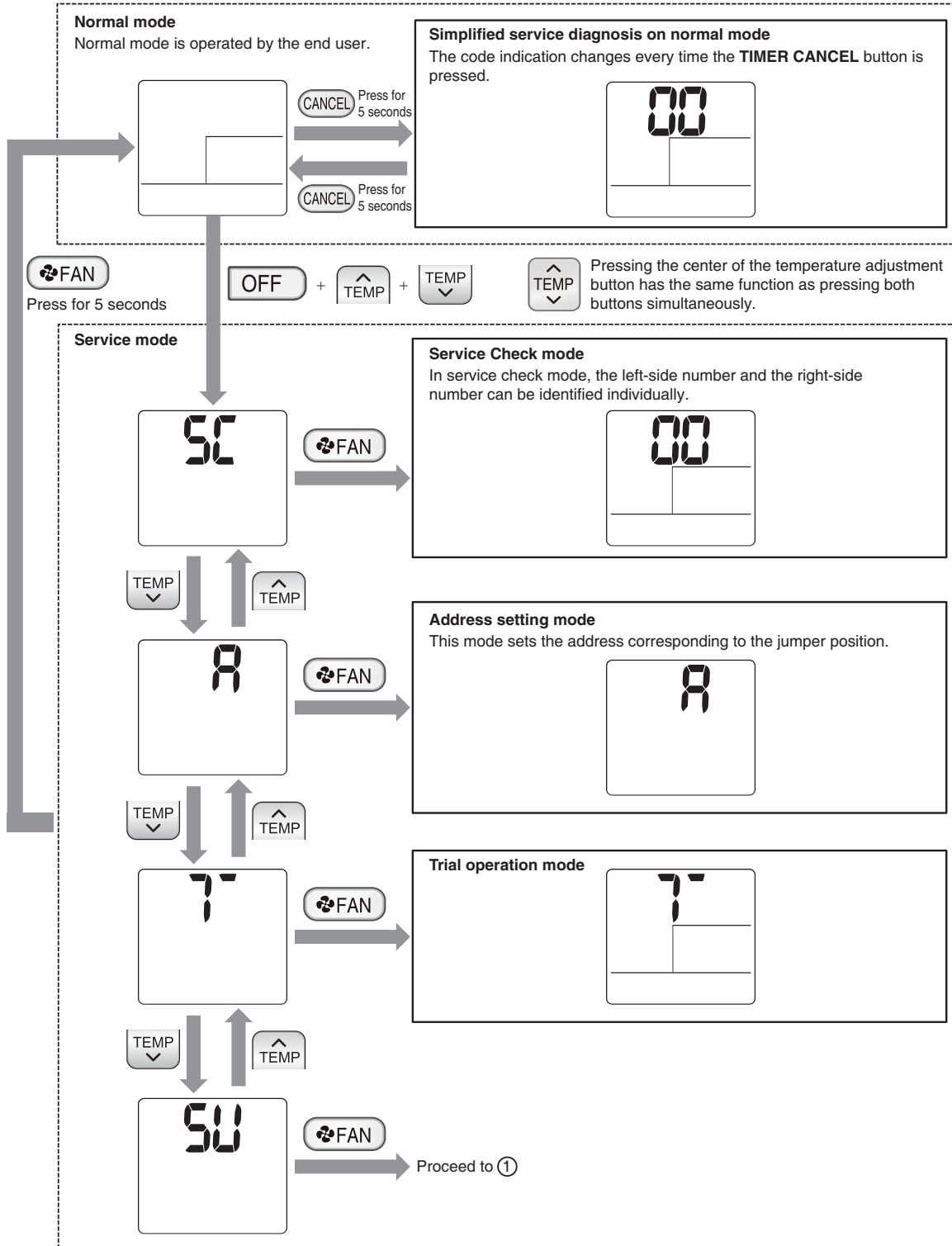

R5000373

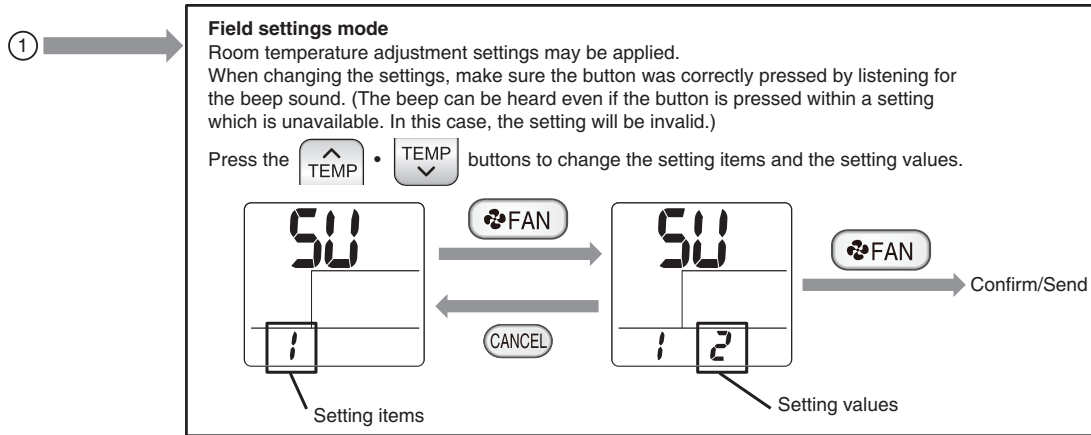

R5000374

Overview of Settings

Setting items		Setting options	Factory Setting	Contents
1	Brightness	0: OFF 1: Dark 2: Bright	2	Brightness of indoor unit LED lamp
2	Filter cleaning setting	0: Short 1: Long	N/A	Determines the duration/time to display Filter cleaning sign.
3	Suspend	0: OFF 1: ON	N/A	Activation/Deactivation of Standby electricity saving (suspend function) 0: Power will still be supplied to the outdoor unit PCB after the unit operation stopped. 1: Three minutes after the unit operation stops, the power supply to the outdoor unit PCB is shut off.
4	Dry keep	0: OFF 1: ON	0	Stops the airflow of indoor unit when the thermostat is OFF to prevent increase of room humidity. 0: When thermostat is OFF, the fan rotor will still be OPERATING, hence there is airflow. 1: When thermostat is OFF, the fan rotor will be STOPPED, hence there is no airflow.
5	Preheating control	0: OFF 1: ON	N/A	Activation/Deactivation of compressor preheating 0: Deactivation of compressor preheating 1: Activation of compressor preheating
6	Room temperature adjustment (cooling)	0: Low 2 (-4°C) 1: Low 1 (-2°C) 2: Standard (0°C) 3: High 1 (+2°C) 4: High 2 (+4°C)	2	Adjustment of indoor temperature thermistor in cooling operation Used for adjustment of room temperature control.
7	Room temperature adjustment (heating)	0: Low 2 (-4°C) 1: Low 1 (-2°C) 2: Standard (0°C) 3: High 1 (+2°C) 4: High 2 (+4°C)	2	Adjustment of indoor temperature thermistor in heating operation. Used for adjustment of room temperature control.
8	Airflow setting when thermostat off during cooling operation	0: Keep 1: Soft breeze	N/A	Airflow setting when indoor unit thermostat is off. 0: Same airflow as "thermostat on" 1: Lowered to LL tap
9	Wireless/HA priority setting during automatic operation	0: Wireless 1: HA	N/A	Determination of priority control method when HA system is used. 0: Wireless remote controller can be used. 1: Temperature setting from wireless remote controller is disabled.
10	Auto-restart	0: OFF 1: ON	N/A	This setting decides the operation of the unit when the power supply resumed after a power supply shutdown (i.e. power failure). 0: When the power supply resumes, the unit remains in stopped operation. 1: When the power supply resumes, the unit resumes the operation before the shutdown of power supply.

**Note**

After replacing the indoor unit PCB, all the values are returned to the factory settings. Use the remote controller to change the settings again. When only the remote controller is replaced, the values stored in the PCB remain the same. There is no hassle to the end user.

5. Field Settings for FDMQ Series

5.1 How to Change the Field Settings

Outline

If optional accessories are mounted on the indoor unit, the indoor unit setting may have to be changed. Refer to the instruction manual for each optional accessory.

i Note

When using 2 remote controllers for 1 indoor unit, change the field settings from MAIN remote controller. Note that the field settings cannot be set from SUB remote controller.

Procedure

BRC1E73 Wired Remote Controller

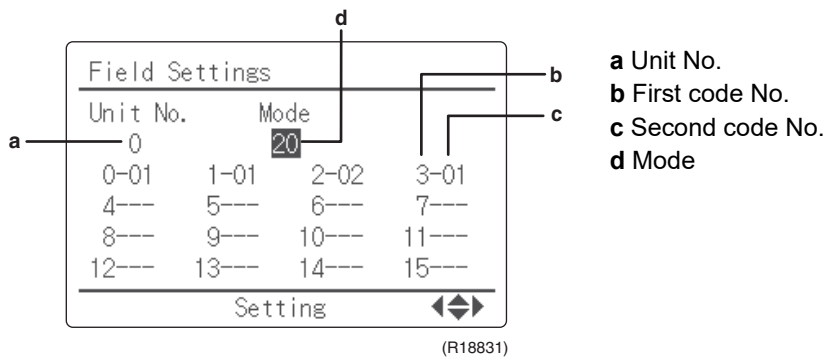

1. Press and hold **Cancel** button for 4 seconds or longer. Service settings menu is displayed.

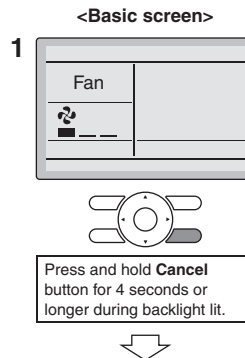

2. Select **Field Settings** in the Service Settings menu, and press **Menu/OK** button. Field settings screen is displayed.

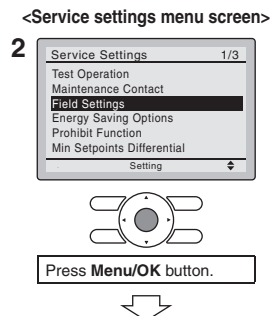

3. Highlight the mode, and select desired "Mode No." by using ▲ ▼ (Up/Down) button.
4. In the case of setting per indoor unit during group control (When Mode No. such as 20, 22, 23, 25 are selected), highlight the unit No. and select "Indoor unit No." to be set by using ▲ ▼ (Up/Down) button. (In the case of group setting, this operation is not needed.)

[In the case of individual setting per indoor unit, current settings are displayed. And, SECOND CODE NO. " - " means no function.]

5. Highlight SECOND CODE NO. of the FIRST CODE NO. to be changed, and select desired "SECOND CODE NO." by using ▲ ▼ (Up/Down) button. Multiple identical mode number settings are available.

[In the case of setting for all indoor units in the remote control group, available SECOND CODE NO. is displayed as " * " which means it can be changed. When SECOND CODE NO. is displayed as " - ", there is no function.]

<Service settings screen>

In the case of individual setting per indoor unit

In the case of group total setting

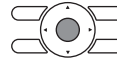

Press Menu/OK button.

6. Press **Menu/OK** button. Setting confirmation screen is displayed.
7. Select **Yes** and press **Menu/OK** button. Setting details are determined and field settings screen returns.
8. In the case of multiple setting changes, repeat 3 to 7.
9. After all setting changes are completed, press **Cancel** button twice.
10. Backlight goes out, and **[Checking the connection. Please stand by.]** is displayed for initialization. After the initialization, the basic screen returns.



<Setting confirmation screen>



Press Menu/OK button.



Setting confirmation

BRC082A43 Wireless Remote Controller

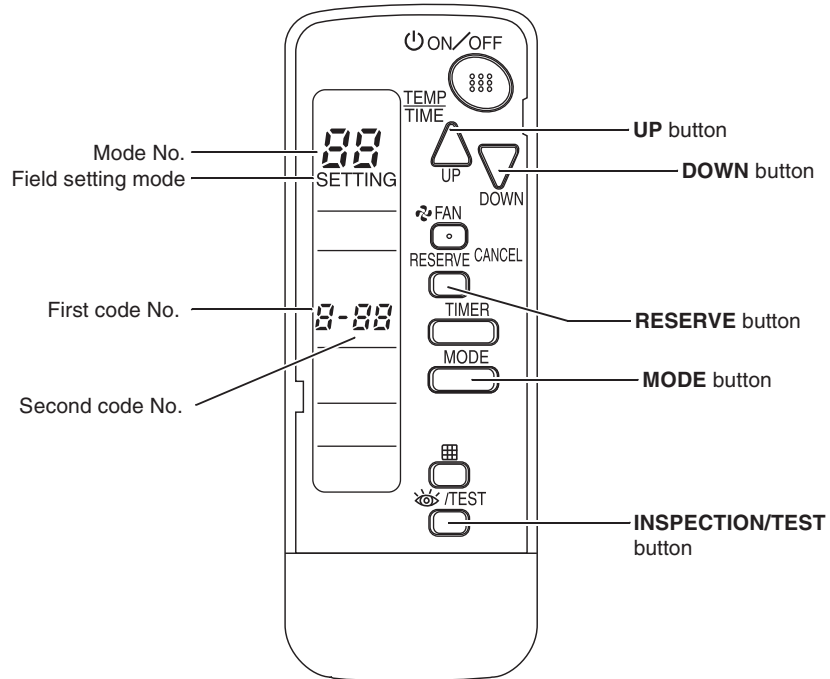

R7000287

To set the field settings, you have to change:

- Mode No.
- First code No.
- Second code No.

1. When in normal mode, hold down /TEST button for at least 4 seconds to enter the Field Set mode.
2. Select the desired Mode No. with **MODE** button.
3. Press button and select the First code No.
4. Press button and select the Second code No.
5. Press **RESERVE** button to confirm the settings.
6. Press /TEST button to quit the Field Set mode and to return to normal display again.

5.2 Overview of Field Settings

Mode No.	First Code No.	Second Code No.			Description of setting			
		01	02	03				
10 (20)	0	Light★	Approx. 2,500 hrs.★	Heavy	Approx. 1,250 hrs.	—	Filter cleaning sign interval (used to change filter cleaning display interval according to filter contamination)	Longlife filter
			Approx. 200 hrs.★					Approx. 100 hrs.
	3	Display★	No display	—	Filter cleaning sign (used to set filter cleaning display ON/OFF)			
11 (21)	7	OFF★	Air volume adjustment completion	Air volume adjustment start	Air volume adjustment			

★ Factory Setting



Note(s)

- The Second Code No. is factory set to "01".
- Do not use any settings not listed in the table.
- For group control with a wireless remote controller, initial settings for all the indoor units of the group are equal.
For group control, refer to the installation manual attached to the indoor unit for group control.

External Static Pressure Settings

12 class

Mode No.	First Code No.	Second Code No.	External static pressure
13 (23)	6	03	30 Pa
		04	40 Pa
		05★	50 Pa★
		06	60 Pa
		07	70 Pa
		08	80 Pa
		09	90 Pa
		10	100 Pa
		11	110 Pa
		12	120 Pa
		13	130 Pa
		14	140 Pa
		15	150 Pa

★ Factory Setting

18/24 class

Mode No.	First Code No.	Second Code No.	External static pressure
13 (23)	6	05 ★	50 Pa ★
		06	60 Pa
		07	70 Pa
		08	80 Pa
		09	90 Pa
		10	100 Pa
		11	110 Pa
		12	120 Pa
		13	130 Pa
		14	140 Pa
		15	150 Pa

★ Factory Setting

5.3 MAIN/SUB and Address Setting for Wireless Remote Controller

Outline

- If setting multiple wireless remote controllers to operate in one room, perform address setting for the receiver and the wireless remote controller.
- If using both a wired remote controller and a wireless remote controller with 1 indoor unit, change the MAIN/SUB switch of the signal receiver PCB.

Signal Receiver PCB Setting

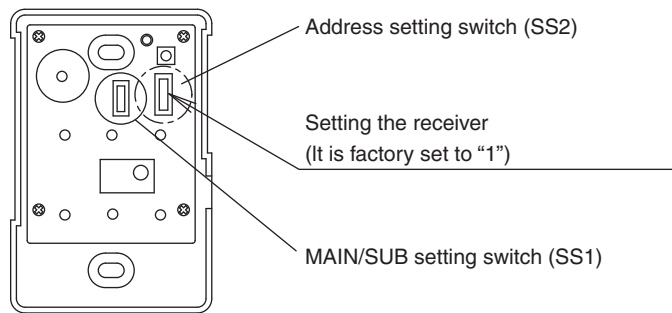

(R24951)



MAIN/SUB switch

Set the MAIN/SUB setting switch (SS1) on the signal receiver PCB to SUB.

	MAIN	SUB
MAIN/SUB setting switch (SS1)		
	R7000181	R7000182



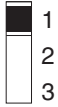





Wireless address switch

Set the address setting switch (SS2) on the signal receiver PCB according to the table below.

	No.1	No.2	No.3
Address setting switch (SS2)			
	R7000183	R7000184	R7000185

Wireless Remote Controller Address

Factory set is 1. Change the wireless remote controller address setting by the following steps, if necessary.

1. Hold down  button and /TEST button at the same time for at least 4 seconds to enter the field setting mode. (SETTING is indicated on the display).
2. Press  FAN button and select display setting ( or ). Each time the button is pressed, the display switches between  and .
3. Press  button and  button to set the address.

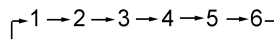

Address can be set from 1 ~ 6, but set it to 1 ~ 3 and to same address as the receiver. The receiver does not work with address 4 ~ 6.

4. Press **RESERVE** button to confirm the setting.
5. Hold down /TEST button to quit the field setting mode and return to the normal display.

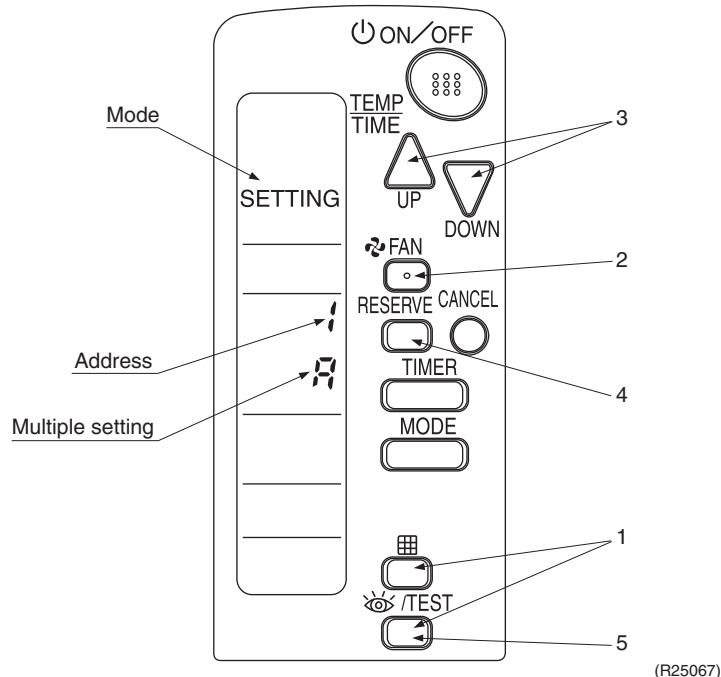

**Multiple Settings
A or b**

When the indoor unit is controlled by an outside controller (central remote controller, etc.), the indoor unit sometimes does not respond to ON/OFF command or temperature setting command from the wireless remote controller. Check what setting the customer needs and make the multiple setting as shown below.

Remote Controller		Indoor Unit	
Multiple settings	Remote controller display	To control other air conditions and units	For other than on left
A: Standard	All items displayed.	Commands other than ON/OFF and temperature setting accepted. (1 LONG BEEP or 3 SHORT BEEPS emitted)	All commands accepted. (2 SHORT BEEPS)
b: Multi System	Operations remain displayed shortly after execution	All commands accepted. (2 SHORT BEEPS)	

After Setting

Stick the Unit No. label on the receiver and the back of the wireless remote controller.

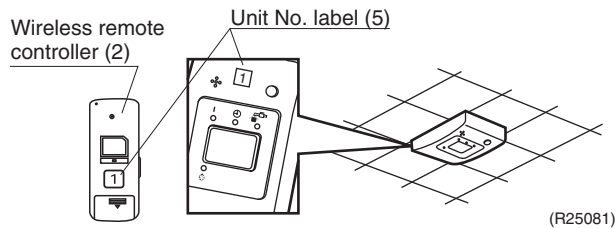

i Note(s)

Set the Unit No. of the receiver and the wireless remote controller to be the equal. If the settings differ, the signal from the remote controller cannot be transmitted.

6. Field Settings for Outdoor Unit

6.1 Facility Setting (cooling at low outdoor temperature)

Outline

This function is limited only for facilities (the target of air conditioning is equipment such as computers). Never use it in a residence or office (the space where there is a human).

Details

■ 09/12/15 class

Cutting jumper 6 (J6) on the circuit board will expand the operation range down to 14°F (−10°C). However it will stop if the outdoor temperature drops below −4°F (−20°C) and start back up once the temperature rises again.

- (1) Remove the top plate of the outdoor unit. (09/12 class: 4 screws, 15 class: 6 screws)
- (2) Remove the front plate. (09/12 class: 5 screws, 15 class: 8 screws)
- (3) Cut the jumper (J6) of the PCB inside.

● 09/12 class

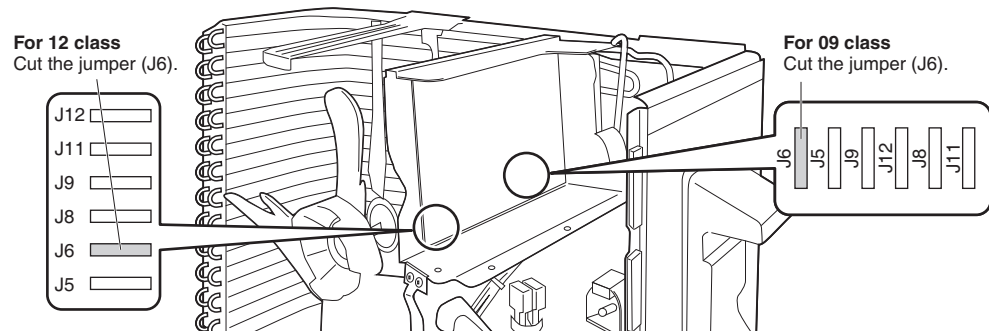

R7000392

● 15 class

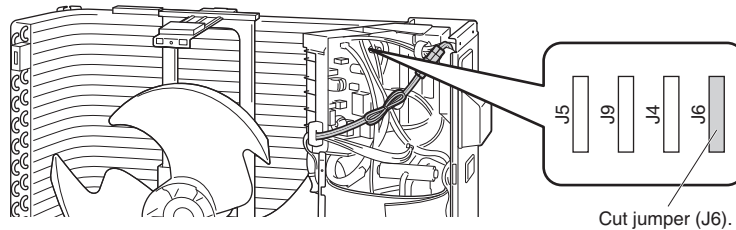

R7000391

■ 18/24 class

Turning on SW5-3 on the PCB will extend the operation range to 14°F (−10°C).

Installing an air direction adjustment grille (sold separately) will further extend the operation range to −4°F (−20°C). In these cases, the unit will stop operating if the outdoor temperature falls below −4°F (−20°C), restarting once the temperature rises above this level.

- (1) Remove the service lid. (2 screws)
- (2) Remove the switch cover. (1 screw)

(3) Turn on SW5-3.

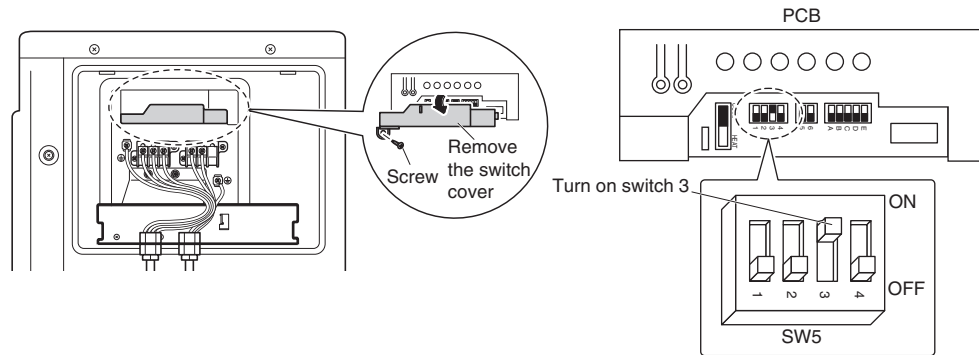

R7000285



Reference

For the location of the jumper, refer to pages 33, 35, 37.



Caution

- If the outdoor unit is installed where the heat exchanger of the unit is exposed to direct wind, provide a windbreak wall.
- Intermittent noises may be produced by the indoor unit due to the outdoor fan turning on and off when using facility settings.
- Do not place humidifiers or other items which might raise the humidity in rooms where facility settings are being used.
A humidifier might cause dew jumping from the indoor unit outlet vent.
- Cutting jumper sets the indoor fan tap to the highest position.



Caution

Replace the PCB if you cut a jumper unintentionally.

Jumpers are necessary for electronic circuit. Improper operation may occur if you cut any of them.

6.2 Warmer Airflow Setting

Outline

The temperature of discharge airflow in heating operation can be adjusted warmer.

- The room temperature will be high when getting close to the set temperature.
- The discharge airflow does not become warmer in other than heating operation.

Procedure

Warmer airflow can be enabled/disabled from remote controller or outdoor unit.

From remote controller

Refer to page 218 for details of setting procedure.

From outdoor unit (RXL09/12/15WMVJU9)

1. Cut the jumper (J5) of the PCB inside.

■ 09/12 class

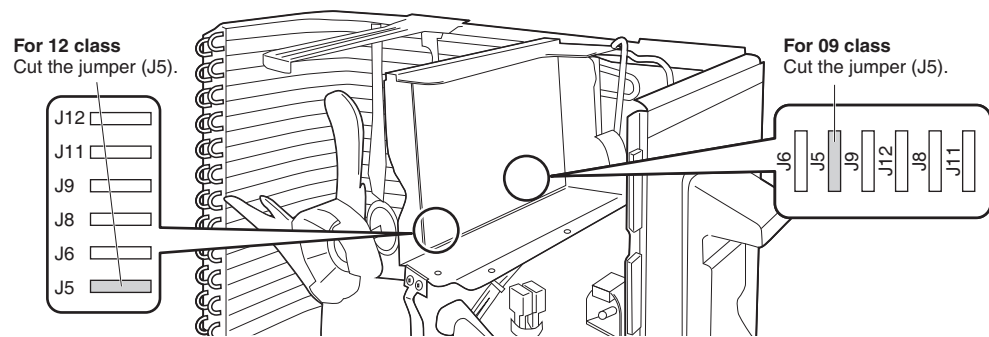

R7000389

■ 15 class

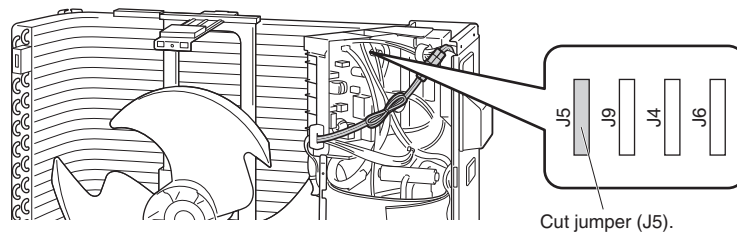

Cut jumper (J5).

R7000388

From outdoor unit (RXL18/24WMVJU9)

1. Remove the switch cover (1 screw) of service monitor PCB.
2. Turn on the SW5-2 on the service monitor PCB.

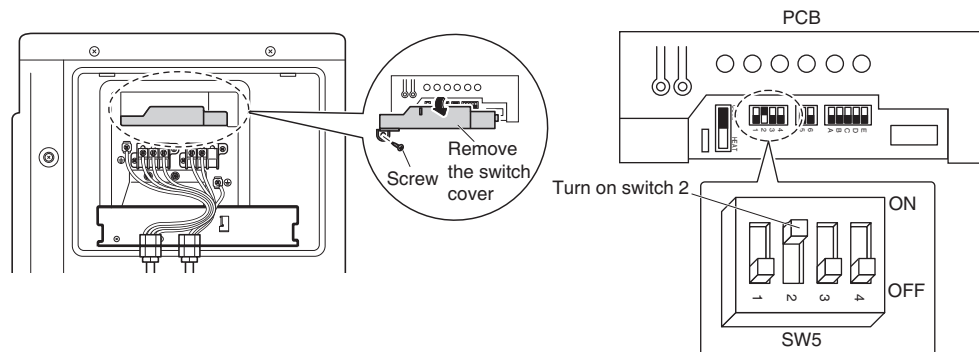

R7000380

**Reference**

For the location of the jumper, refer to page 33, 35, 37.

**Note(s)**

Warmer airflow can be enabled from either indoor or outdoor unit. Warmer airflow becomes available when either one of the RC or outdoor unit setting is enabled. For example, if the outdoor unit has the switch for warmer airflow, it can be set even when it is disabled on the indoor unit. Also, for the wireless remote controller with field setting function, warmer airflow is enabled when set on indoor unit with the remote controller field setting, even when it is disabled on outdoor unit.

6.3 Drain Pan Heater

In high humidity areas or heavy snow areas, it is recommended to attach a drain pan heater to prevent ice build-up from the bottom frame.

For 09/12/15 class

1. Attach the drain pan heater in accordance with the installation manual included with the drain pan heater.
2. Cut the jumper (J9) of the PCB inside.

■ 09/12 class

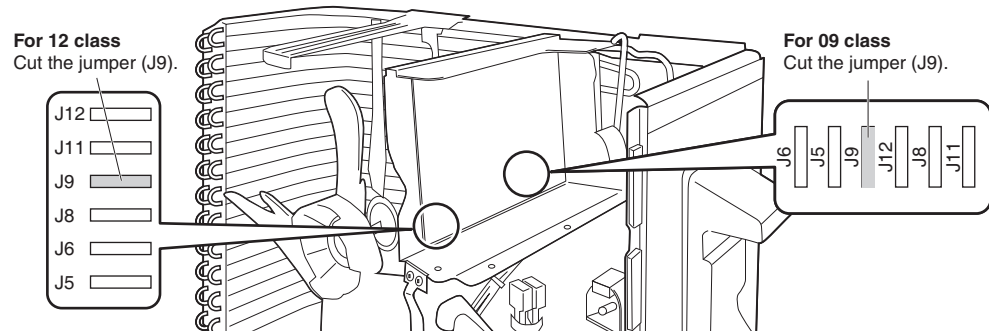

R7000386

■ 15 class

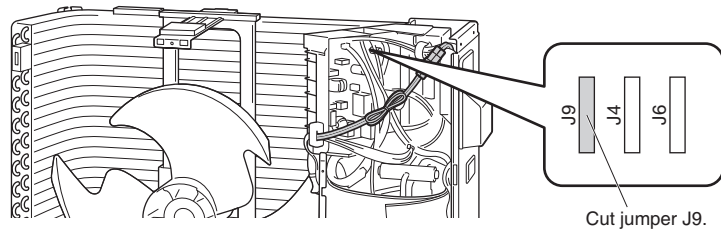

R7000385

For 18/24 class

1. Attach the drain pan heater in accordance with the installation manual included with the drain pan heater.
2. Dismount the service lid by removing the 2 screws.
3. Remove the switch cover (1 screw).
4. Turn on SW6-1 on the PCB.

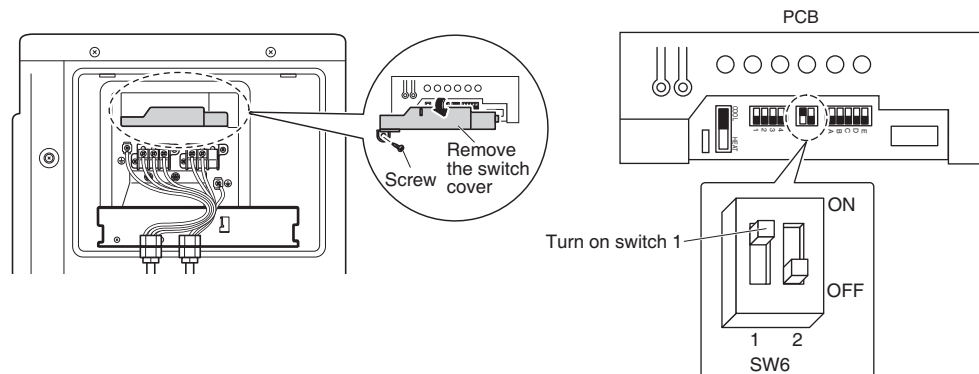

R7000288



Reference

For the location of the jumper, refer to page 33, 35, 37.

7. Silicone Grease on Power Transistor/Diode Bridge

Outline

Apply the specified silicone grease to the heat generation part of a power transistor/diode bridge when you replace an outdoor unit PCB. The silicone grease encourages the heat dissipation of a power transistor/diode bridge.

Details

1. Wipe off the old silicone grease completely.
2. Apply the silicone grease evenly. See the illustrations below for examples of application.
3. Tighten the screws of the power transistor/diode bridge.
4. Make sure that the heat generation parts are firmly contacted to the radiation fin.

Note: Smoke emission may be caused by bad heat radiation when the silicone grease is not appropriately applied.

- OK: Evenly applied

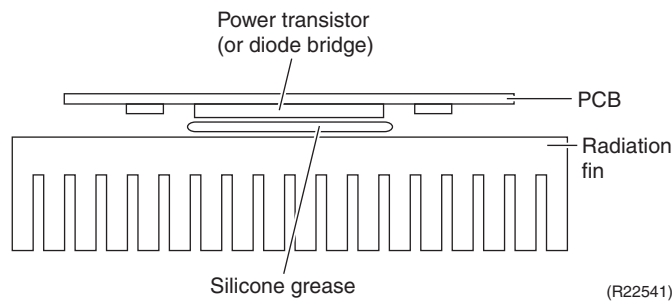

- NG: Not evenly applied

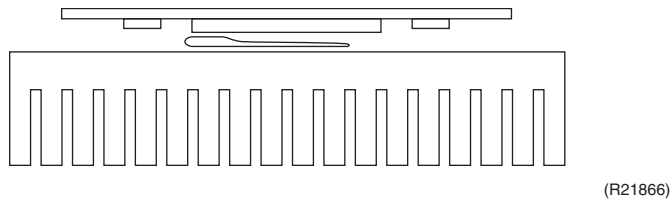

- NG: Foreign matter is stuck.

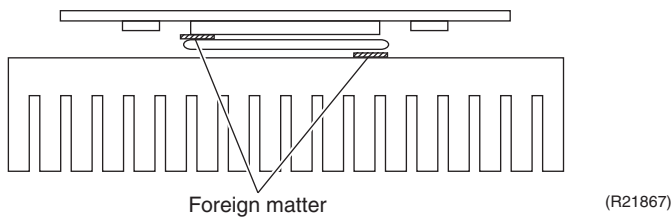

Part 8 Appendix

1. Piping Diagrams.....	235
1.1 Indoor Unit.....	235
1.2 Outdoor Unit.....	237
2. Wiring Diagrams.....	240
2.1 Indoor Unit.....	240
2.2 Outdoor Unit.....	245
3. Operation Limit.....	249

1. Piping Diagrams

1.1 Indoor Unit

FTX09/12WMVJU9

FTX15WMVJU9

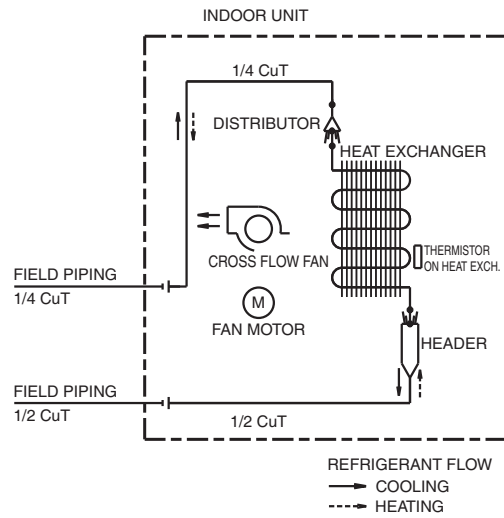
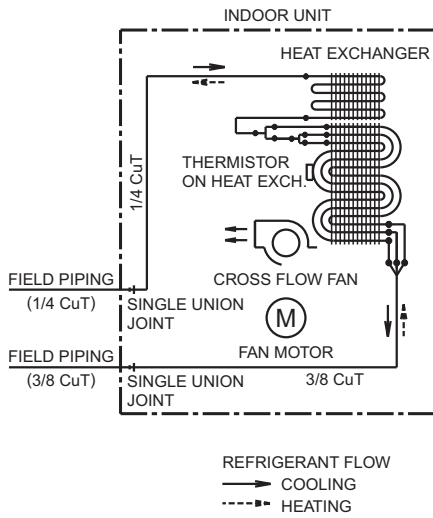

4D091708B

4D091769D

FTX18WVJU9

FTX24WVJU9

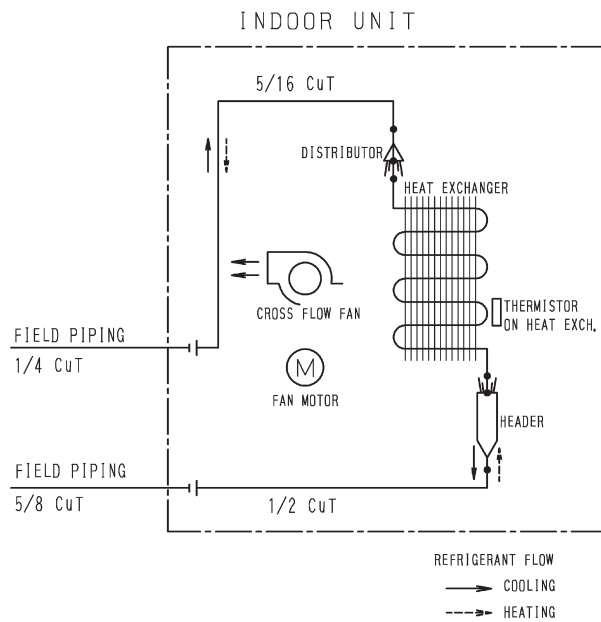
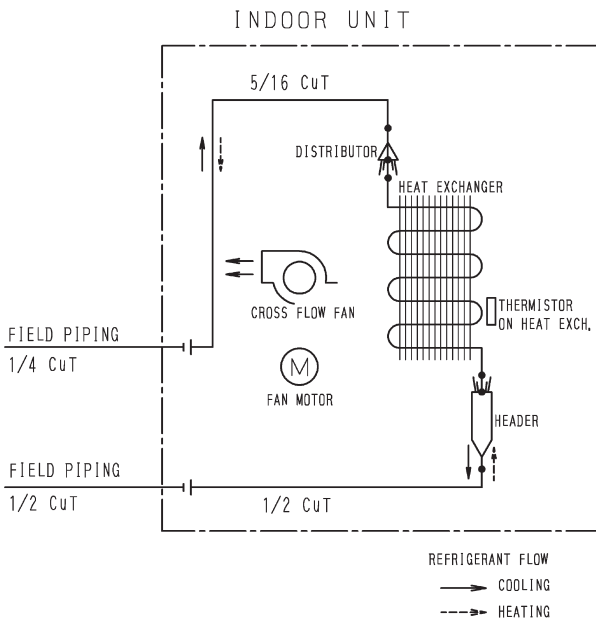

4D074609A

4D074608A

FVXS09/12WVJU9

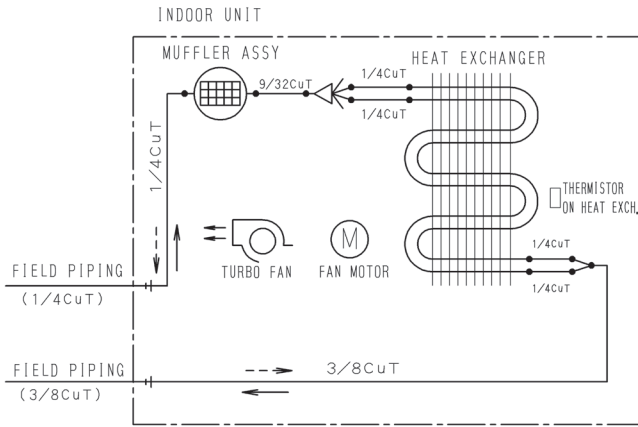

REFRIGERANT FLOW
 —> COOLING
 - -> HEATING

4D091794A

FVXS15WVJU9

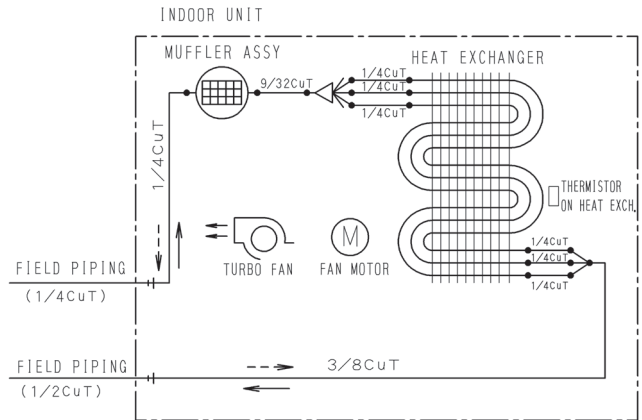

REFRIGERANT FLOW
 —> COOLING
 - -> HEATING

4D091795B

FDMQ12/18/24WVJU9

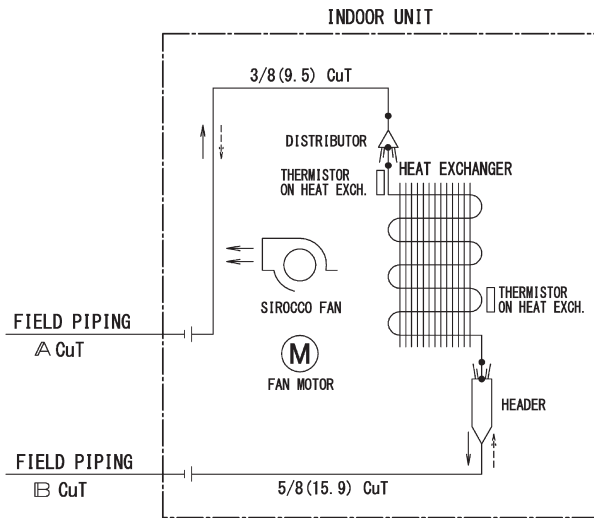

REFRIGERANT FLOW
 —> COOLING
 - -> HEATING

MODEL	A	B
FDMQ09 · 12	1/4 (6.4)	3/8 (9.5)
FDMQ15 · 18	1/4 (6.4)	1/2 (12.7)
FDMQ24	1/4 (6.4)	5/8 (15.9)

C: 4D112974B

1.2 Outdoor Unit

RXL09WMVJU9

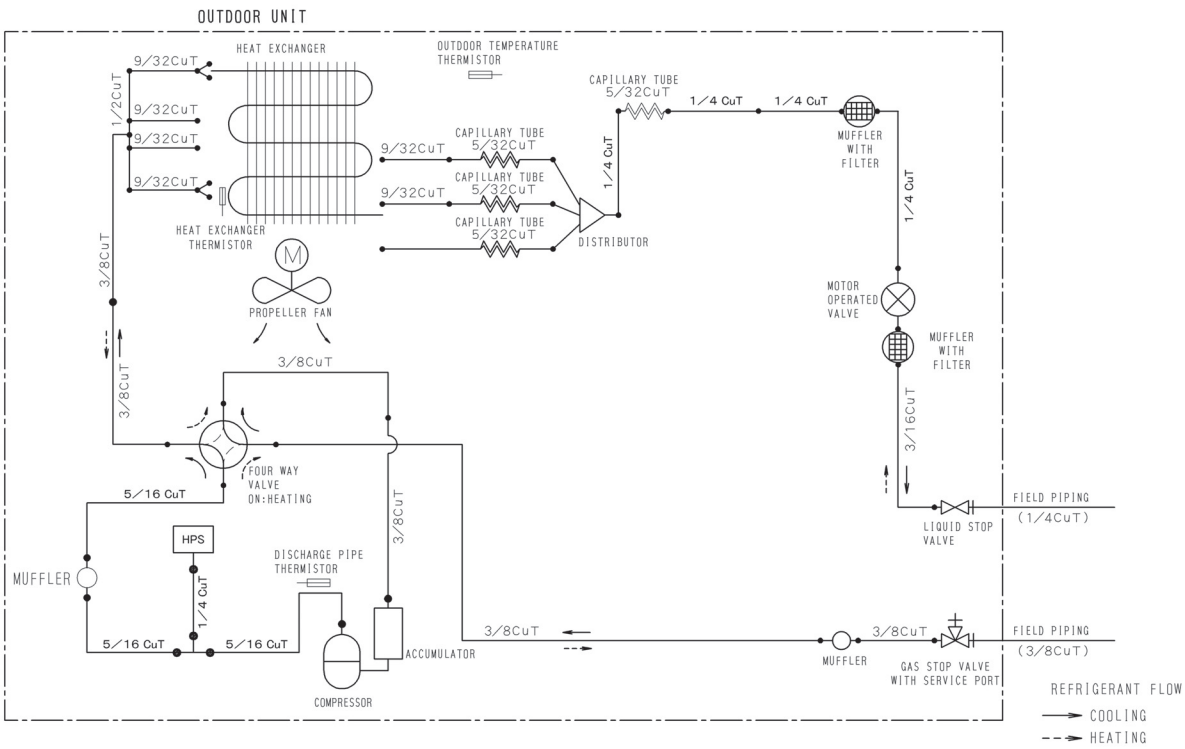

3D135015

RXL12WMVJU9

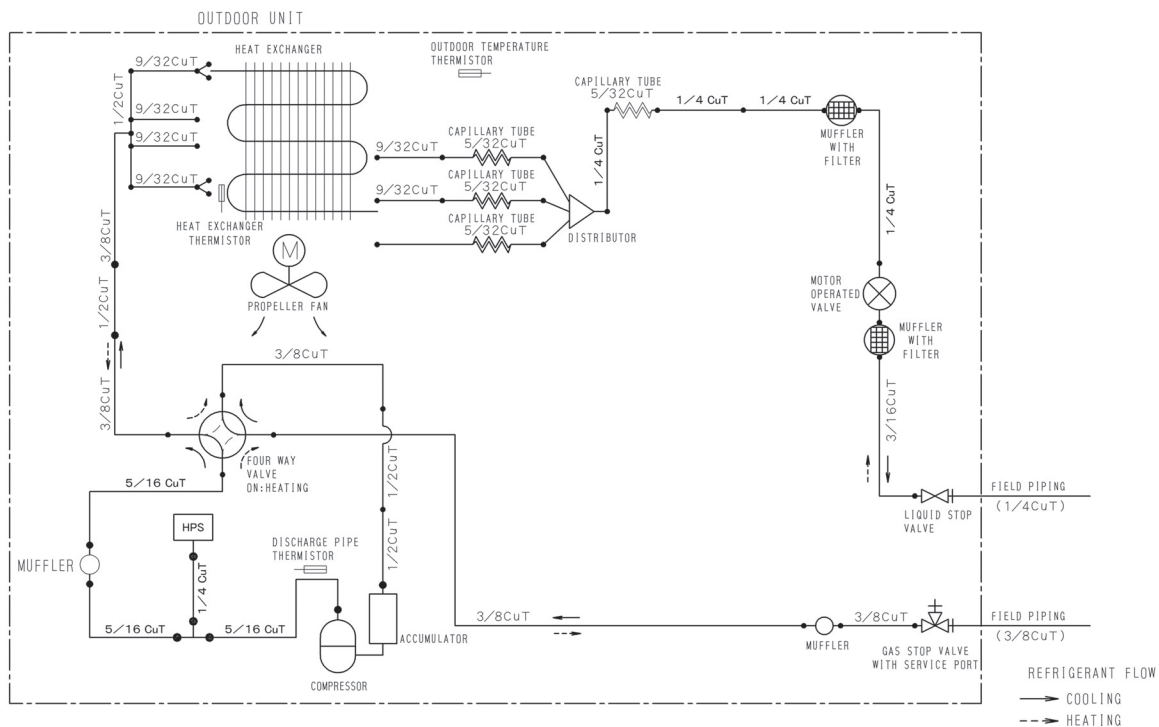

3D135016

RXL15WMVJU9

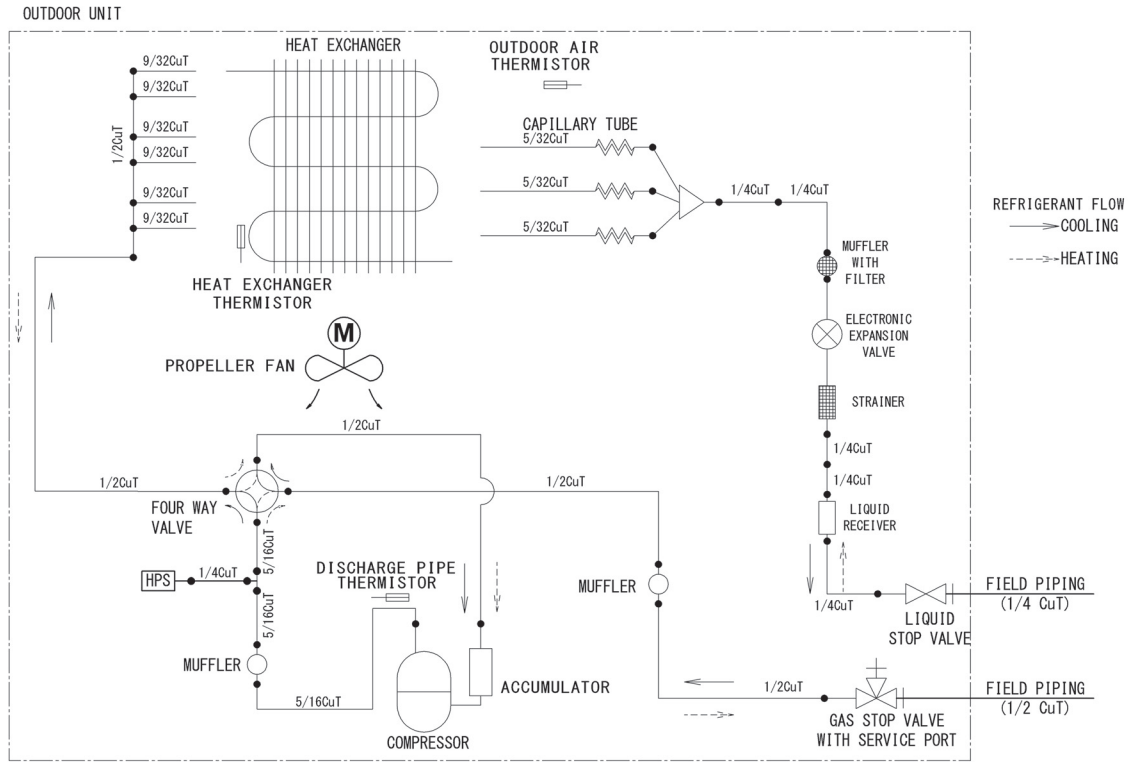

RXL18WMVJU9

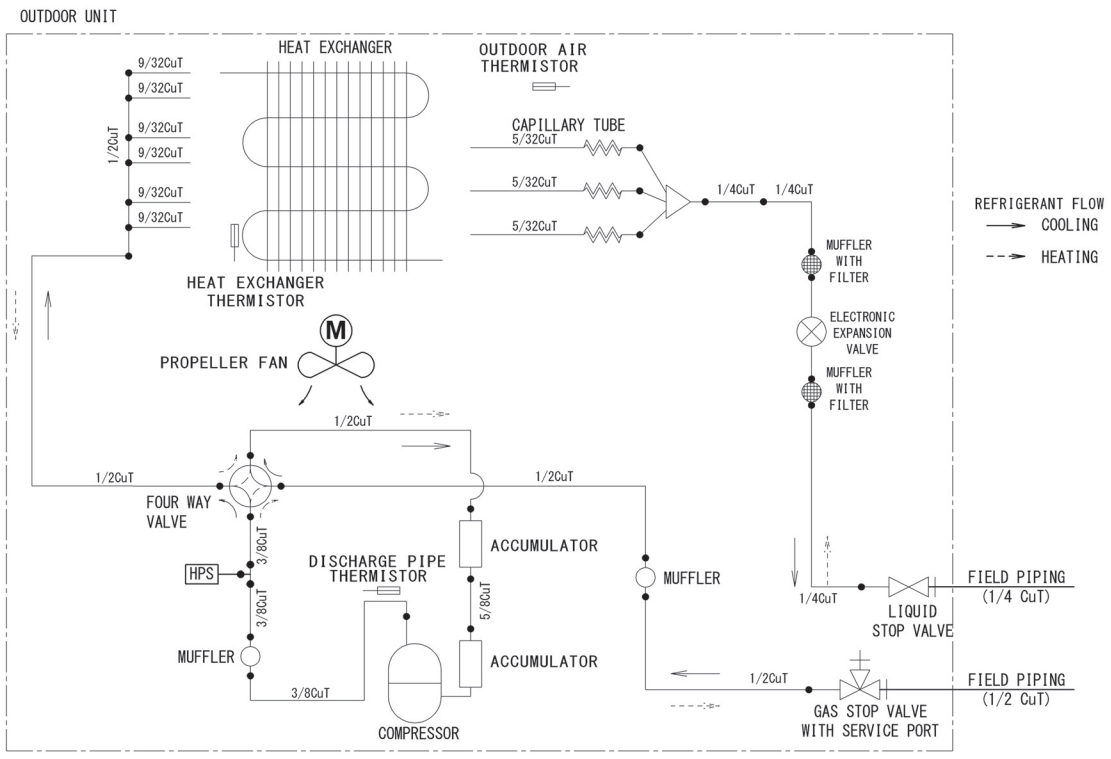

RXL24WMVJU9

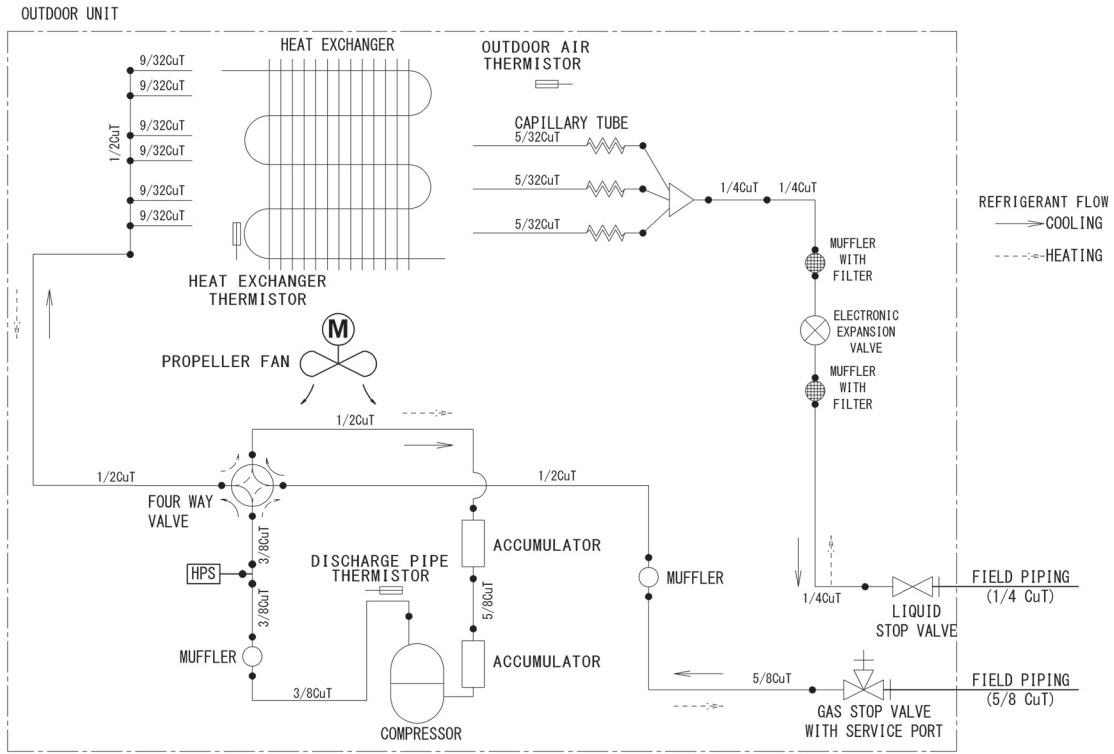

3D141503

2. Wiring Diagrams

2.1 Indoor Unit

FTX09/12WMVJU9

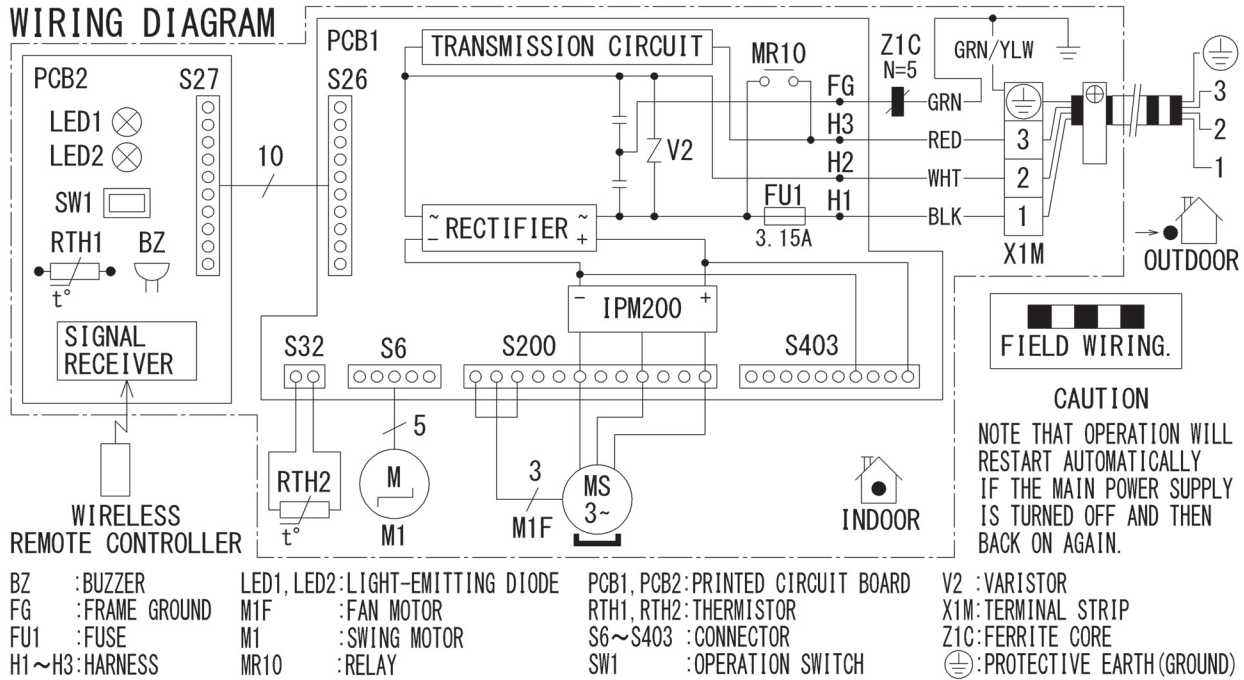

3D142895



Note(s)

PCB1: Control PCB
PCB2: Display/signal receiver PCB
Refer to page 21 for Printed Circuit Board Connector Wiring Diagram.

FTX15WMVJU9

WIRING DIAGRAM

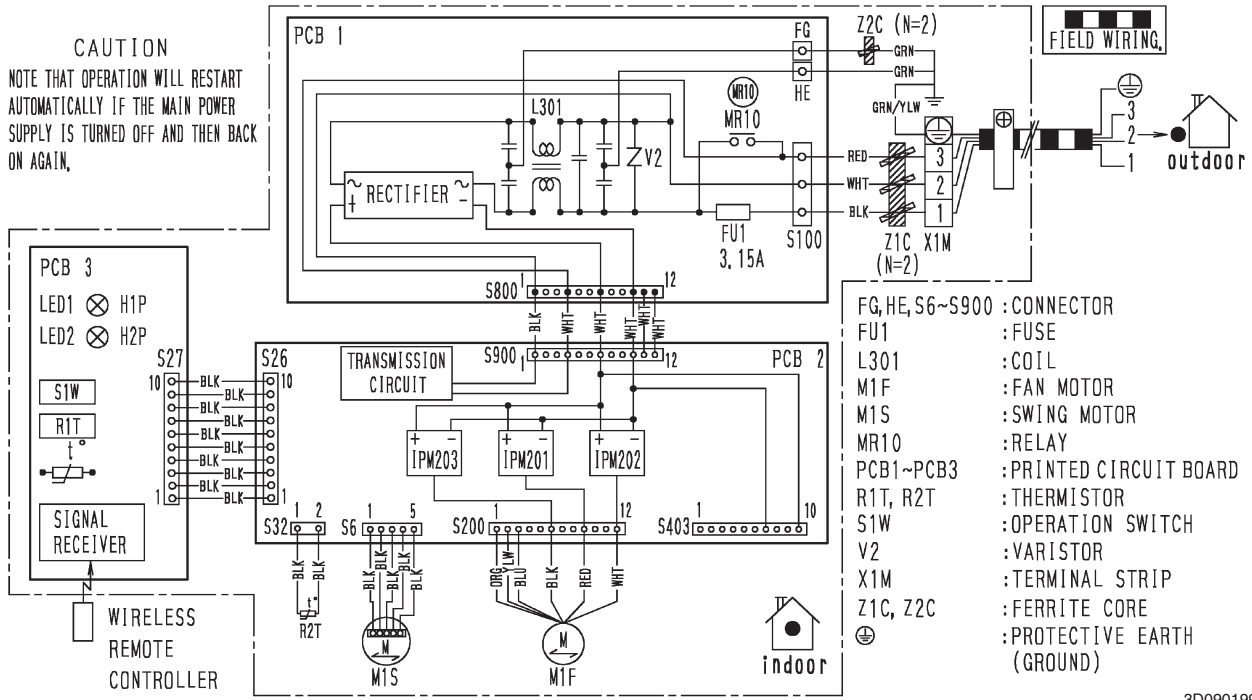

3D090199C



Note(s)

- PCB1: Filter PCB
- PCB2: Control PCB
- PCB3: Display/signal receiver PCB
- Refer to page 23 for Printed Circuit Board Connector Wiring Diagram.

FTX18/24WVJU9

WIRING DIAGRAM

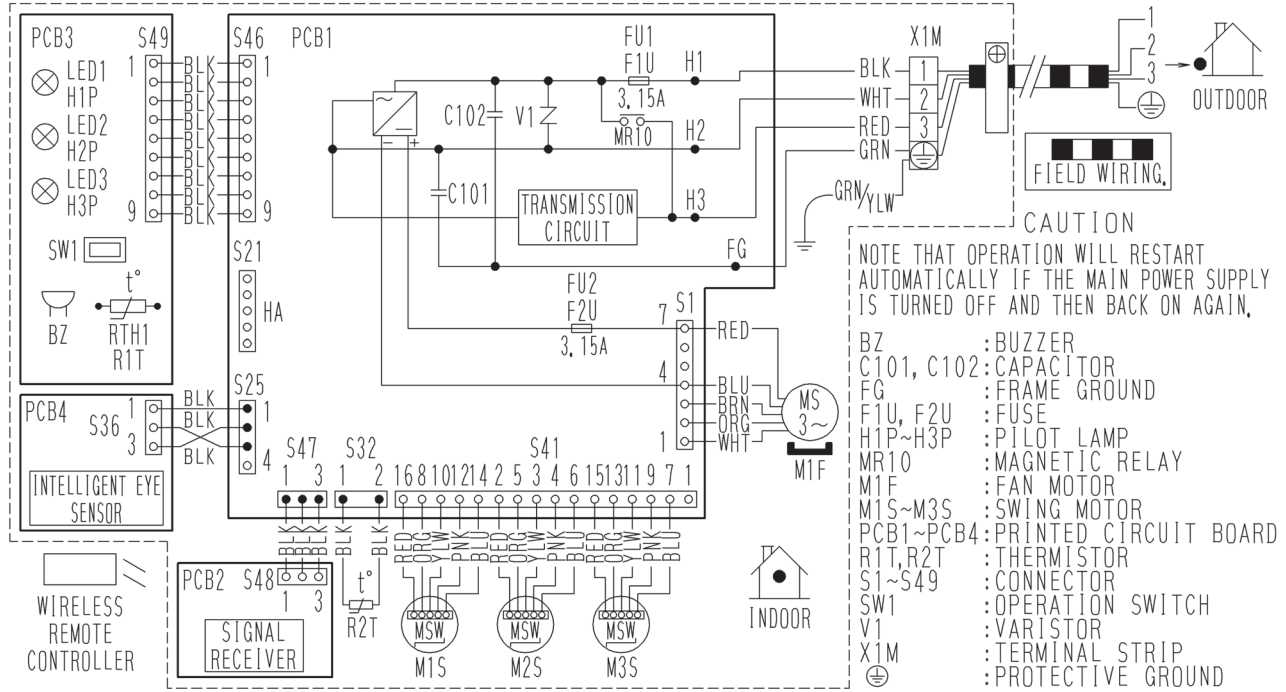

C: 3D060942X



Note(s)

- PCB1: Control PCB
 - PCB2: Signal receiver PCB
 - PCB3: Display PCB
 - PCB4: INTELLIGENT EYE sensor PCB
- Refer to page 25 for Printed Circuit Board Connector Wiring Diagram.

FVXS09/12/15WVJU9

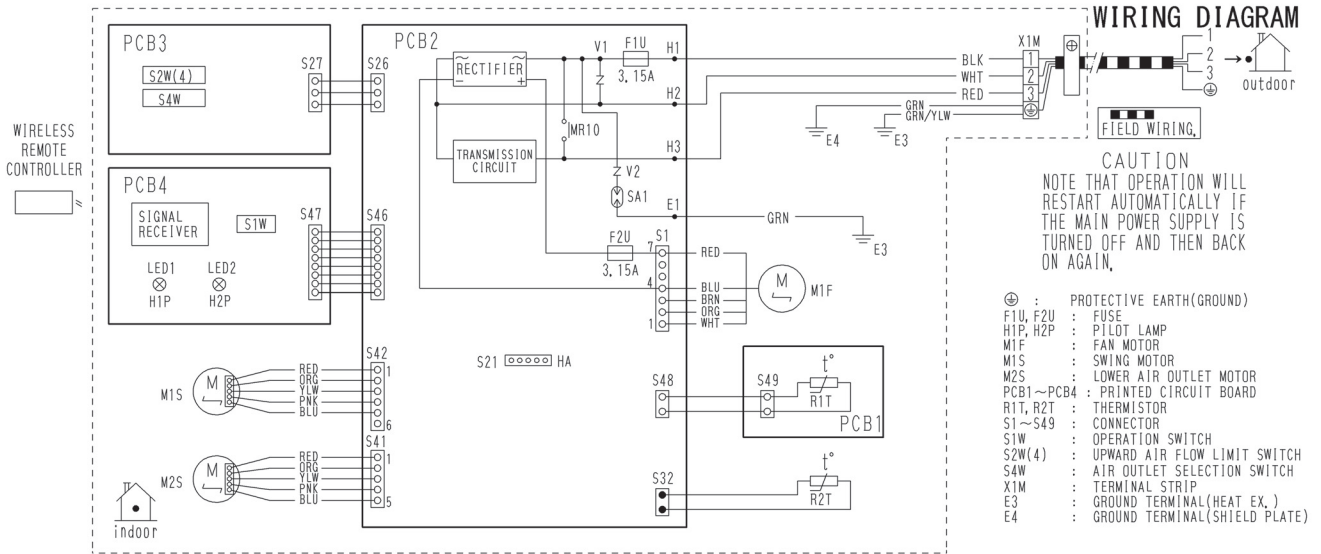

C: 3D090604C



Note(s)

- PCB1: Sensor PCB
 - PCB2: Control PCB
 - PCB3: Service PCB
 - PCB4: Display/signal receiver PCB
- Refer to page 27 for Printed Circuit Board Connector Wiring Diagram.

FDMQ12/18/24WVJU9

WIRING DIAGRAM

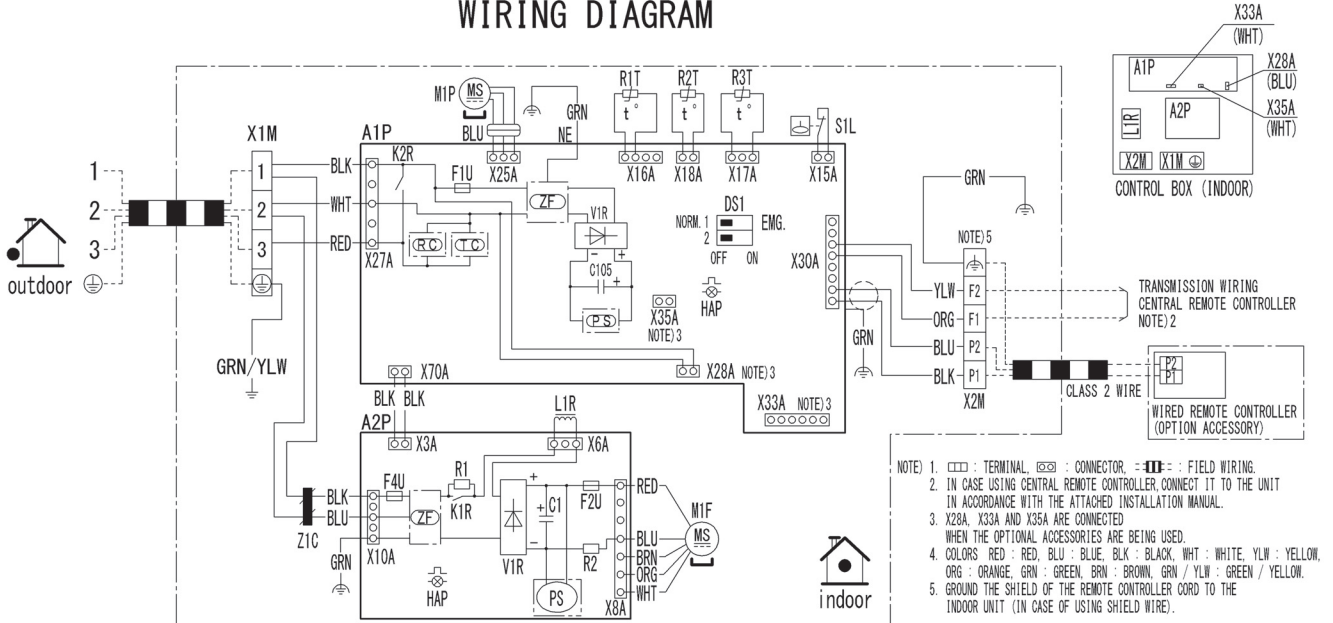

- NOTE) 1. □ : TERMINAL, ⊞ : CONNECTOR, -| | - : FIELD WIRING.
 2. IN CASE USING CENTRAL REMOTE CONTROLLER, CONNECT IT TO THE UNIT IN ACCORDANCE WITH THE ATTACHED INSTALLATION MANUAL.
 3. X28A, X33A AND X35A ARE CONNECTED WHEN THE OPTIONAL ACCESSORIES ARE BEING USED.
 4. COLORS : RED : RED, BLU : BLUE, BLK : BLACK, WHT : WHITE, YLW : YELLOW, ORG : ORANGE, GRN : GREEN, BRN : BROWN, GRN / YLW : GREEN / YELLOW.
 5. GROUND THE SHIELD OF THE REMOTE CONTROLLER CORD TO THE INDOOR UNIT (IN CASE OF USING SHIELD WIRE).

INDOOR UNIT	CONNECTOR	OPTIONAL ACCESSORY
A1P PRINTED CIRCUIT BOARD	X28A	CONNECTOR (POWER SUPPLY FOR WIRING)
A2P PRINTED CIRCUIT BOARD (FAN)	X33A	CONNECTOR (FOR WIRING)
C1 CAPACITOR	X35A	CONNECTOR (ADAPTOR)
C105 CAPACITOR		
DS1 DIP SWITCH (EMERGENCY)		
F1U FUSE (T, 3.15A, 250V)		
F2U FUSE (T, 5A, 250V)		
F4U FUSE		
HAP PILOT LAMP (SERVICE MONITOR-GREEN)		
K1R MAGNETIC RELAY		
K2R MAGNETIC RELAY		
L1R REACTOR		
M1P MOTOR (FAN INDOOR)		
M1P MOTOR (DRAIN PUMP)		
R1 RESISTOR (CURRENT LIMITING)		
R2 CURRENT SENSING DEVICE		
R1T THERMISTOR (SUCTION AIR)		
R2T THERMISTOR (HEAT EXCHANGER)		
S1L FLOAT SWITCH		
V1R DIODE BRIDGE		
X1M TERMINAL BLOCK (POWER SUPPLY)		
X2M TERMINAL BLOCK (CONTROL)		
ZF NOISE FILTER		
Z1C FERRITE CORE		
PS SWITCHING POWER SUPPLY		
RC RECEIVER		
TC TRANSMITTER		

i Note(s)

A1P: Control PCB
 A2P: Indoor fan PCB
 Refer to page 29 for Printed Circuit Board Connector Wiring Diagram.

3D112629B

2.2 Outdoor Unit

RXL09WMVJU9

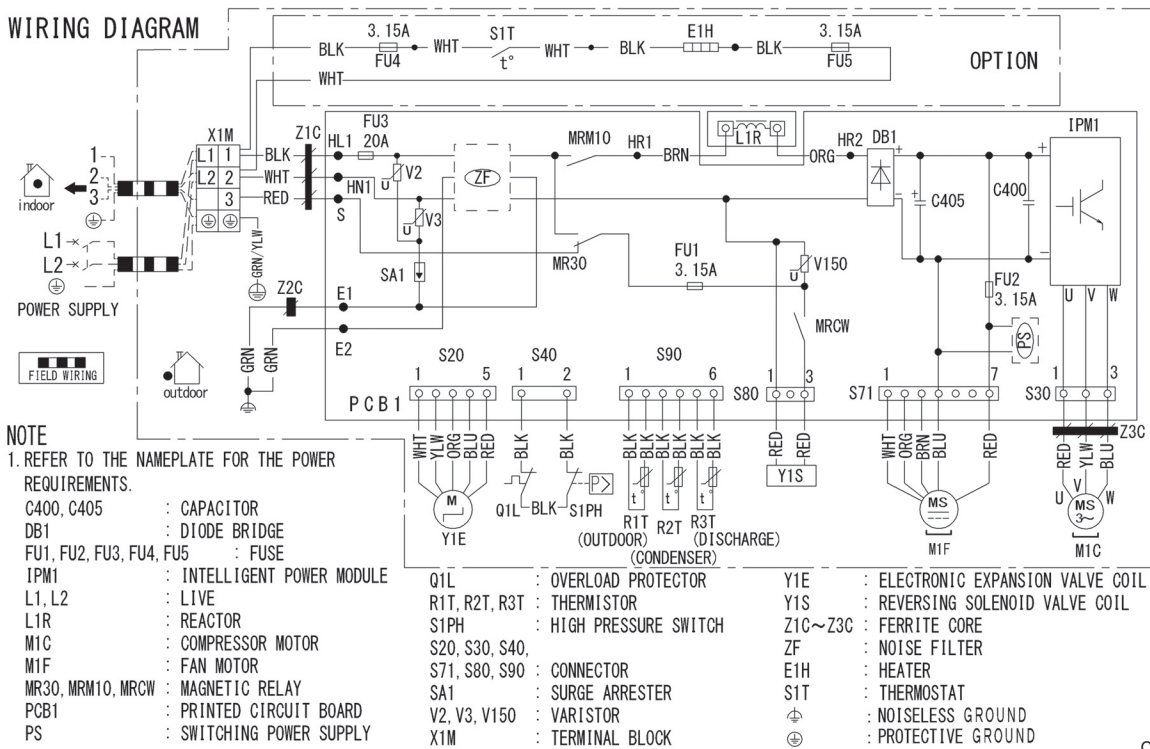

C: 3D134975



Note(s)

PCB1: Main PCB

Refer to page 33 for Printed Circuit Board Connector Wiring Diagram.

RXL12WMVJU9

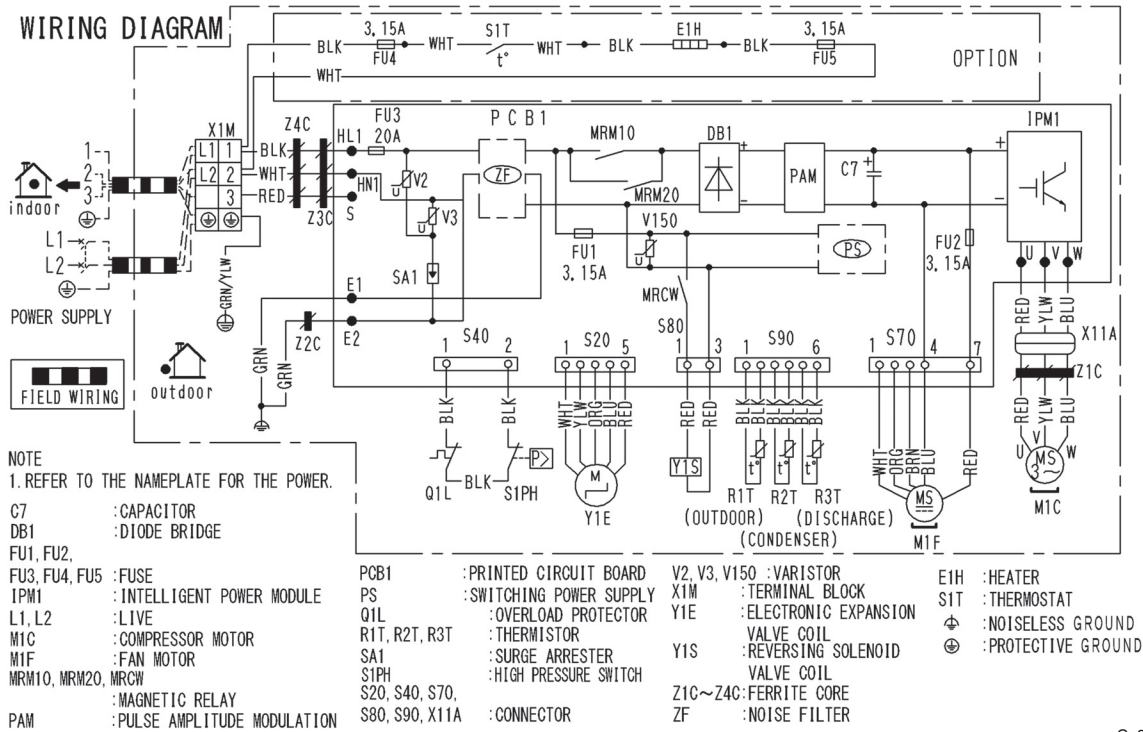

C: 3D134919



Note(s)

PCB1: Main PCB
 Refer to page 35 for Printed Circuit Board Connector Wiring Diagram.

RXL15WMVJU9

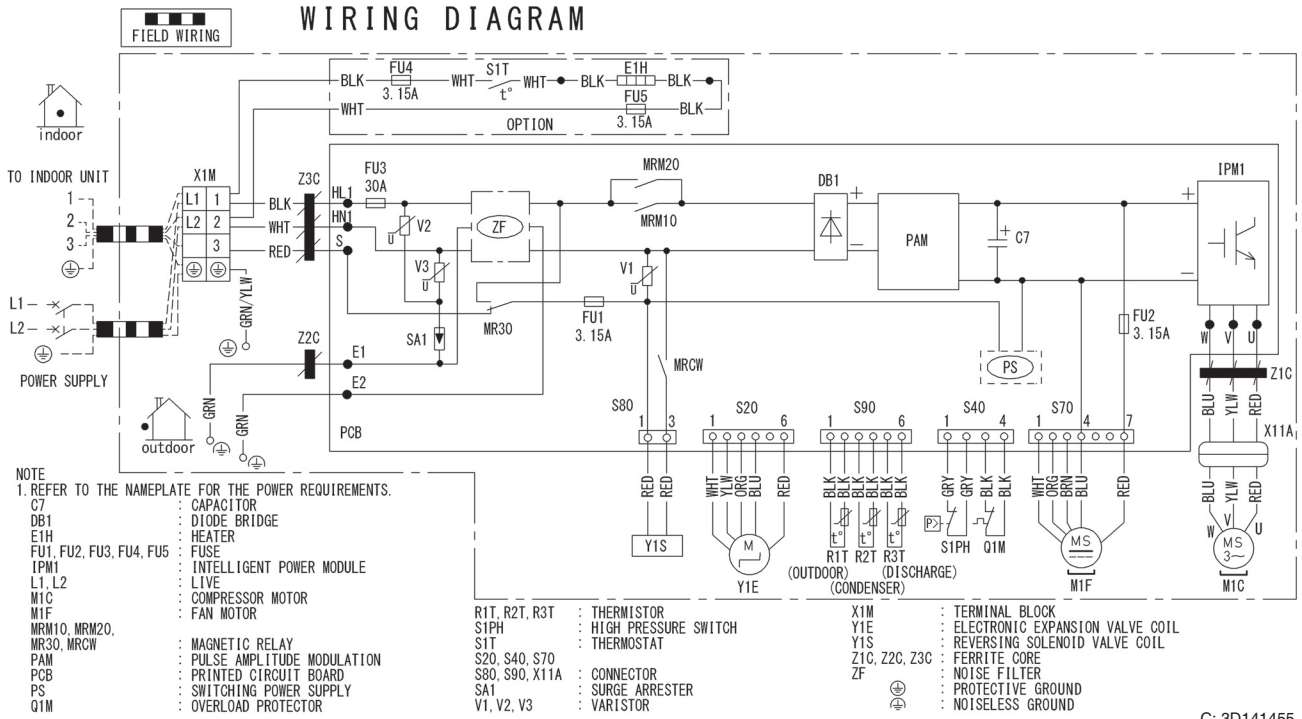

Note(s)

PCB: Main PCB

Refer to page 37 for Printed Circuit Board Connector Wiring Diagram.

RXL18/24WMVJU9

WIRING DIAGRAM

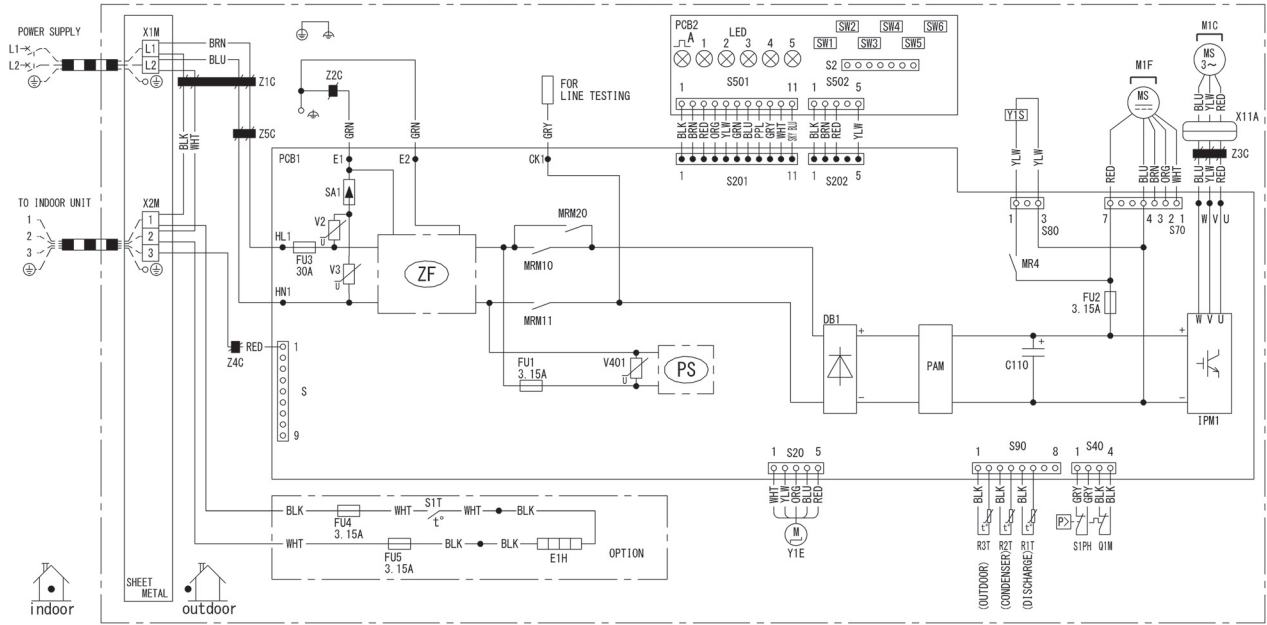

- | | | | |
|---------------------------------|---|--|--|
| C110 : CAPACITOR | MR4, MRM10 : MAGNETIC RELAY | S1T : THERMOSTAT | ZF : NOISE FILTER |
| DB1 : DIODE BRIDGE | MRM11, MRM20 : PULSE AMPLITUDE MODULATION | SA1 : SURGE ARRESTER | ⊕ : PROTECTIVE GROUND |
| E1H : HEATER | PAM : PRINTED CIRCUIT BOARD | SHEET METAL : TERMINAL BLOCK FIXED PLATE | ⊖ : NOISELESS GROUND |
| FU1~FU5 : FUSE | PCB1, 2 : PRINTED CIRCUIT BOARD | SW5, SW6 : FUNCTION SW | |
| IPM1 : INTELLIGENT POWER MODULE | PS : SWITCHING POWER SUPPLY | V2, V3, V401 : VARIATOR | NOTE : SW1~SW4 AND LED1~LED5 DO NOT WORK |
| L1, L2 : LIVE | S1T : OVERLOAD PROTECTOR | X1M, X2M : TERMINAL BLOCK | |
| LEDA : PILOT LAMP | R1T~R3T : THERMISTOR | ZF : ELECTRONIC EXPANSION VALVE COIL | |
| M1C : COMPRESSOR MOTOR | S, S2~S502, X11A : CONNECTOR | Y1S : REVERSING SOLENOID VALVE COIL | |
| MIF : FAN MOTOR | S1PH : HIGH PRESSURE SWITCH | Z1G~Z5C : FERRITE CORE | |

C: 3D141469



Note(s)

PCB1: Main PCB
 PCB2: Service monitor PCB
 Refer to page 38 for Printed Circuit Board Connector Wiring Diagram.

3. Operation Limit

RXL09/15WMVJU9

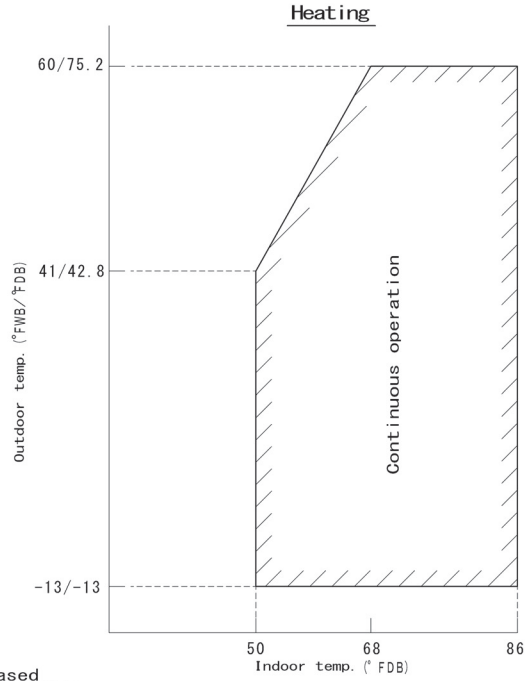
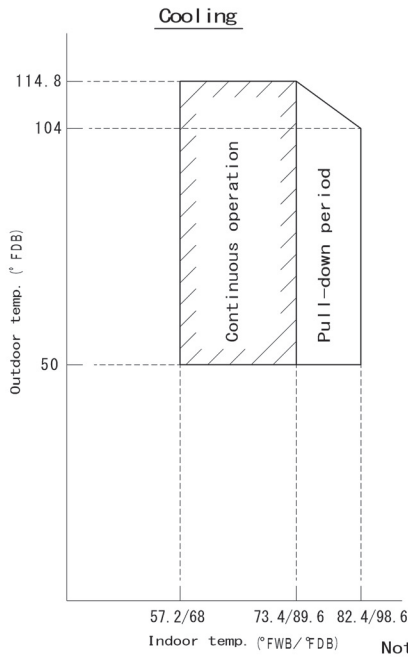

Notes:
 The graphs are based on the following conditions.

- Equivalent piping length 25ft
- Level difference 0ft
- Air flow rate High

3D100732A

RXL12/18/24WMVJU9

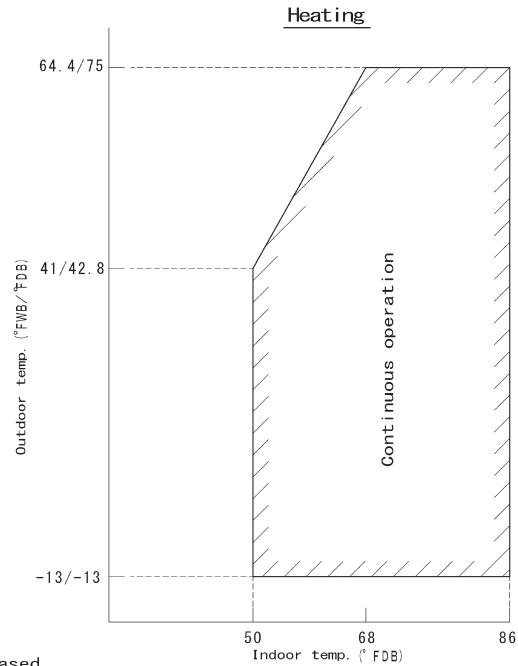
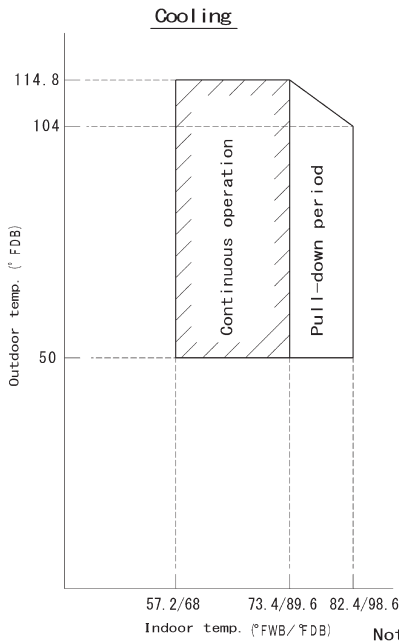

Notes:
 The graphs are based on the following conditions.

- Equivalent piping length 25ft
- Level difference 0ft
- Air flow rate High

3D123451

Warning

- Daikin products are manufactured for export to numerous countries throughout the world. Prior to purchase, please confirm with your local authorized importer, distributor and/or retailer whether this product conforms to the applicable standards, and is suitable for use, in the region where the product will be used. This statement does not purport to exclude, restrict or modify the application of any local legislation.
- Ask a qualified installer or contractor to install this product. Do not try to install the product yourself. Improper installation can result in water or refrigerant leakage, electrical shock, fire or explosion.
- Use only those parts and accessories supplied or specified by Daikin. Ask a qualified installer or contractor to install those parts and accessories. Use of unauthorized parts and accessories or improper installation of parts and accessories can result in water or refrigerant leakage, electrical shock, fire or explosion.
- Read the user's manual carefully before using this product. The user's manual provides important safety instructions and warnings. Be sure to follow these instructions and warnings.

If you have any inquiries, please contact your local importer, distributor and/or retailer.

Cautions on product corrosion

1. Air conditioners should not be installed in areas where corrosive gases, such as acid gas or alkaline gas, are produced.
2. If the outdoor unit is to be installed close to the sea shore, direct exposure to the sea breeze should be avoided. If you need to install the outdoor unit close to the sea shore, contact your local distributor.

© All rights reserved